

### Product Overview

Qorvo's QPA2211T is a Ka-band power amplifier fabricated on Qorvo's 0.15um GaN on SiC process (QGaN15), mounted to a high thermal conductivity tab. Operating between 27.5 and 31 GHz, it achieves 5 W linear power with -25 dBc intermodulation distortion products and 26 dB small signal gain. Saturated output power is 14 W with power-added efficiency of 34%.

QPA2211T is ideally suited to support satellite communications and 5G infrastructure.

To simplify system integration, the QPA2211T is fully matched to 50 ohms with integrated DC blocking caps on both I/O ports.

The QPA2211T is 100% DC and RF tested on-wafer to ensure compliance to electrical specifications.

Lead-free and RoHS compliant.



### Key Features

- Frequency Range: 27.5–31 GHz
- $P_{SAT}$  ( $P_{IN}=24$  dBm): 41.5 dBm
- PAE ( $P_{IN}=24$  dBm): 34 %
- Power Gain ( $P_{IN}=24$  dBm): 17 dB
- IMD3 (at 34 dBm/tone): -25 dBc
- Small Signal Gain: 26 dB
- Bias:  $V_D = 22$  V,  $I_{DQ} = 280$  mA
- Tab dimensions: 2.946 mm x 2.769 mm x 0.254 mm

*Performance is typical across frequency. Please reference electrical specification table and data plots for more details.*

### Functional Block Diagram

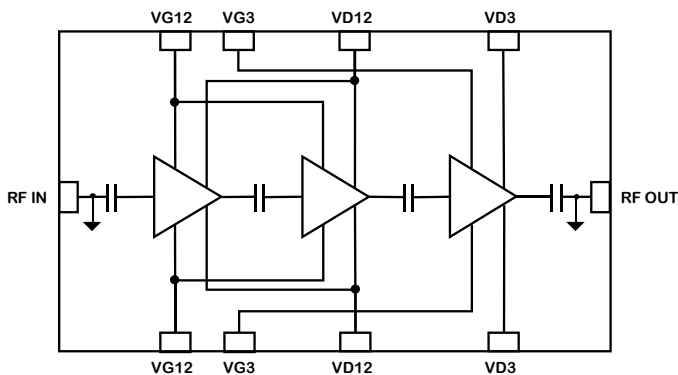

### Applications

- 5G Infrastructure
- Satellite Communications

### Ordering Information

Part No.	Description
QPA2211T	27.5–31 GHz 14 Watt GaN Amplifier (100 Pcs.)

## Absolute Maximum Ratings

Parameter	Value / Range
Drain Voltage ( $V_D$ )	29.5 V
Gate Voltage Range ( $V_G$ )	-5 V to 0 V
Drain Current ( $I_D$ )	5600 mA
Gate Current ( $I_G$ )	See plot pg. 17
Power Dissipation ( $P_{DISS}$ ), 85 °C	40 W
Input Power ( $P_{IN}$ ), 50 $\Omega$ , $V_D=22$ V, $I_{DQ}=280$ mA, 85 °C	36 dBm
Input Power ( $P_{IN}$ ), 3:1 VSWR, $V_D=22$ V, $I_{DQ}=280$ mA, 85 °C	36 dBm
Storage Temperature	-55 to +150 °C

Operation of this device outside the parameter ranges given above may cause permanent damage. These are stress ratings only, and functional operation of the device at these conditions is not implied.

## Recommended Operating Conditions

Parameter	Value / Range
Drain Voltage ( $V_D$ )	22 V
Drain Current ( $I_{DQ}$ )	280 mA
Operating Temperature	-40 to +85 °C

Electrical specifications are measured at specified test conditions. Specifications are not guaranteed over all recommended operating conditions.

## Electrical Specifications

Parameter		Min	Typ	Max	Units
Operational Frequency		27.5		31	GHz
Output Power ( $P_{IN}=24$ dBm) <sup>1</sup>	27.5 GHz		42.1		dBm
	29 GHz		41.7		dBm
	31 GHz		40.8		dBm
Power Added Efficiency ( $P_{IN}=24$ dBm)	27.5 GHz		42.5		%
	29 GHz		37.7		%
	31 GHz		34.1		%
Small Signal Gain	27.5 GHz		26		dB
	29 GHz		27		dB
	31 GHz		26		dB
Input Return Loss	27.5 GHz		35		dB
	29 GHz		15		dB
	31 GHz		12		dB
Output Return Loss	27.5 GHz		3		dB
	29 GHz		10		dB
	31 GHz		19		dB
IMD3 ( $P_{OUT}/Tone=34$ dBm, 10 MHz tone spacing)	27 GHz		-29		dBc
	29 GHz		-33		dBc
	31 GHz		-33		dBc
$P_{OUT}$ Temp. Coeff. (85 °C to 25 °C, $P_{IN} = 24$ dBm))			-0.027		dB/°C
Sm. Sig. Gain Temp. Coefficient (85 °C to -40 °C)			-0.099		dB/°C

Test conditions, unless otherwise noted:  $T = +25$  °C,  $V_D = 22$  V,  $I_{DQ} = 280$  mA  
All performance data presented is for the QPA2211D (bare die)

<sup>1</sup> Typical  $P_{SAT}$  is QPA2211D data measured on a QPA2211D evaluation board. Manufacturing test RF probe minimum  $P_{SAT}$  specification is 40.0 dBm at 27.5, 28, 29, and 30 GHz, and 39 dBm at 31 GHz.

## Performance Plots – Large Signal

Test conditions, unless otherwise noted:  $V_D = 22\text{ V}$ ,  $I_{DQ} = 280\text{ mA}$ ,  $T = +25\text{ }^\circ\text{C}$ ,  $P_{IN} = 24\text{ dBm}$   
All performance data presented is for the QPA2211D (bare die).

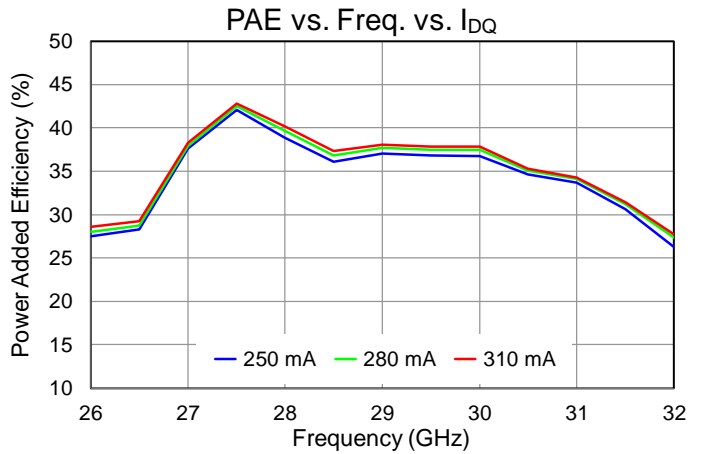
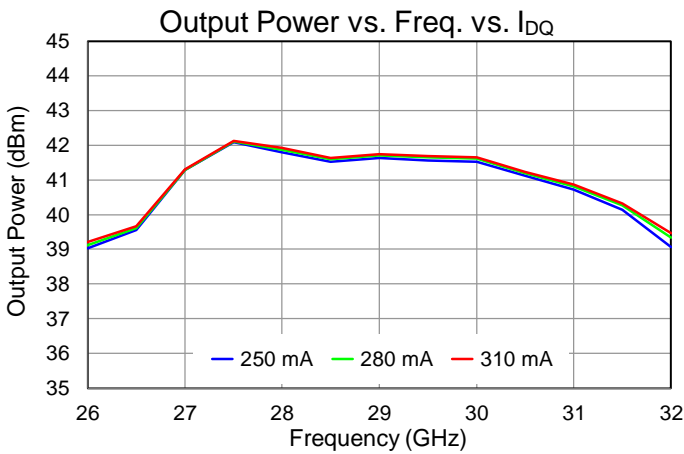
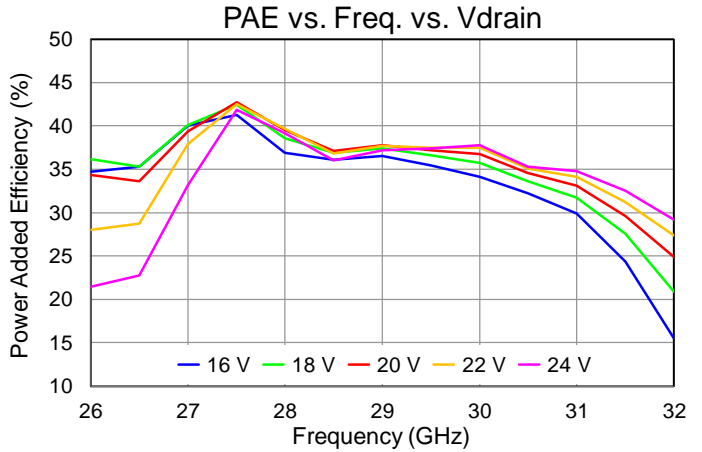
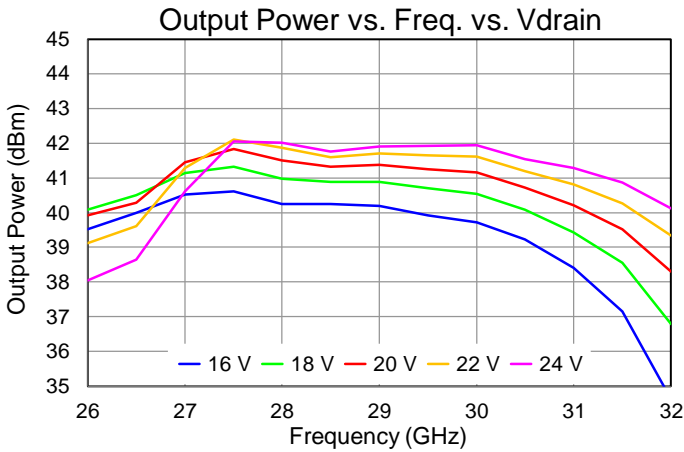
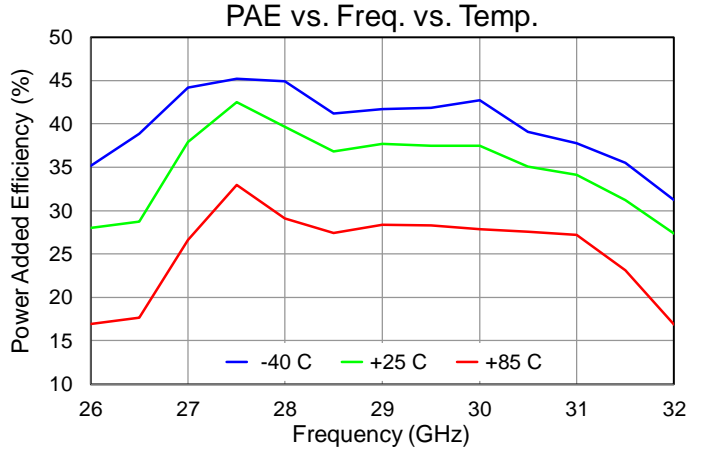
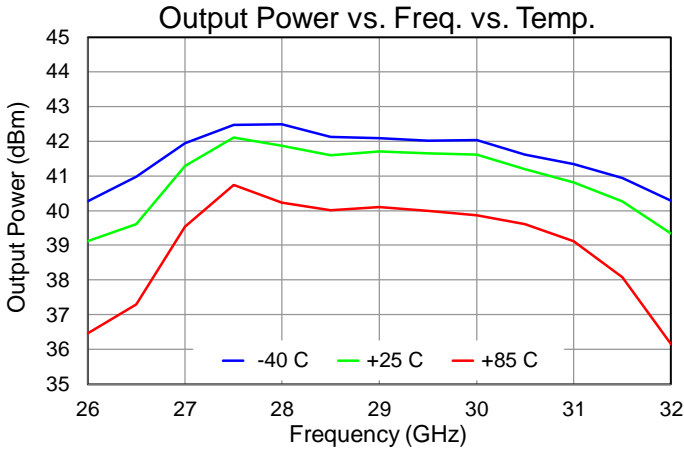

## Performance Plots – Large Signal

Test conditions, unless otherwise noted:  $V_D = 22\text{ V}$ ,  $I_{DQ} = 280\text{ mA}$ ,  $T = +25\text{ }^\circ\text{C}$ ,  $P_{IN} = 24\text{ dBm}$   
All performance data presented is for the QPA2211D (bare die).

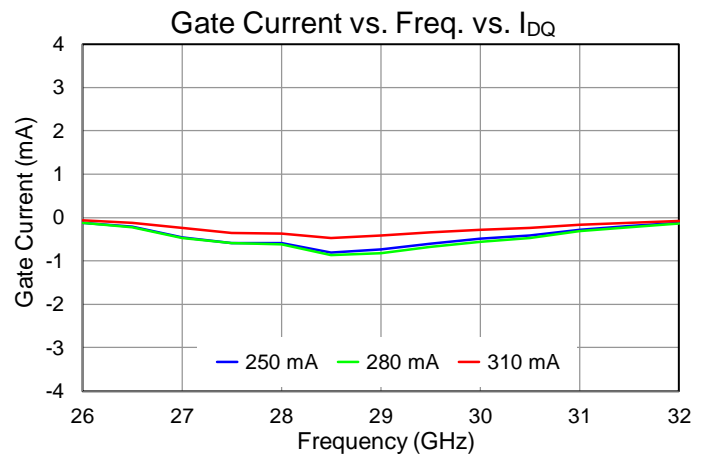
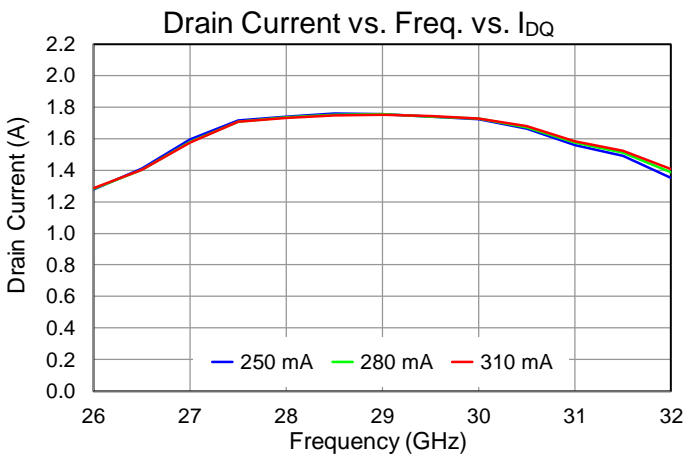
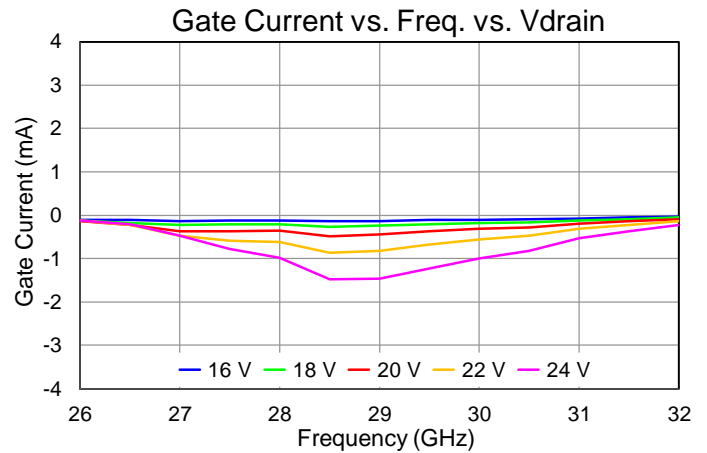
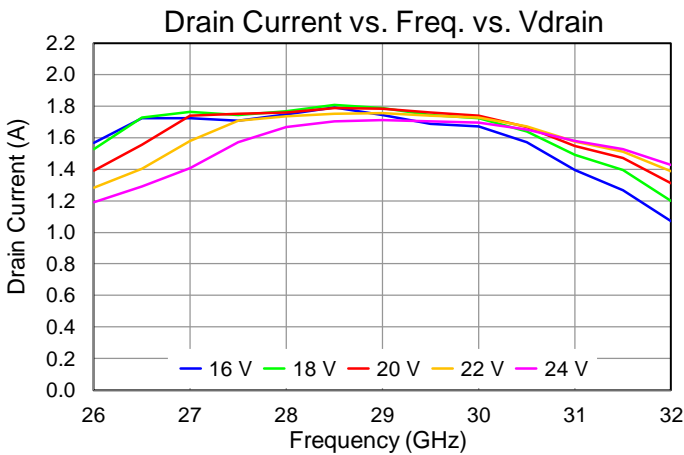
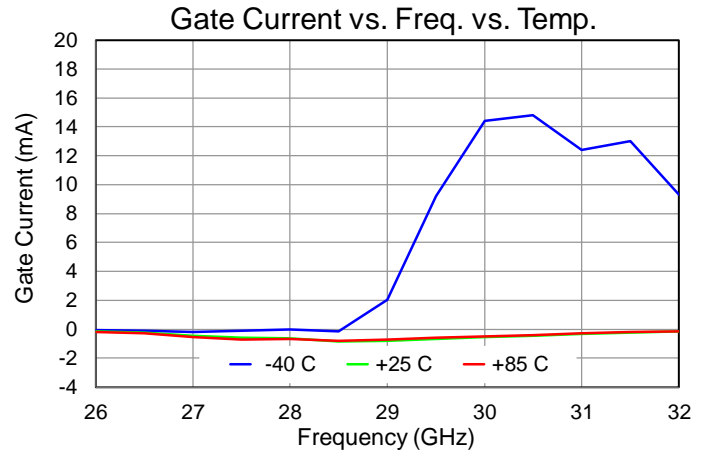
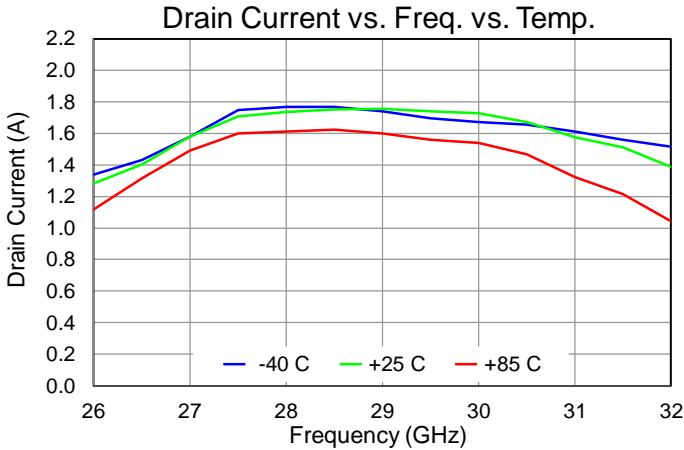

## Performance Plots – Large Signal

Test conditions, unless otherwise noted:  $V_D = 22\text{ V}$ ,  $I_{DQ} = 280\text{ mA}$ ,  $T = +25\text{ }^\circ\text{C}$   
All performance data presented is for the QPA2211D (bare die).

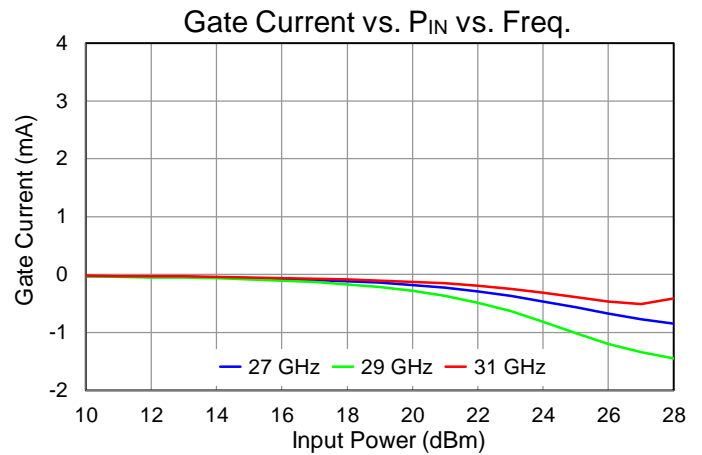
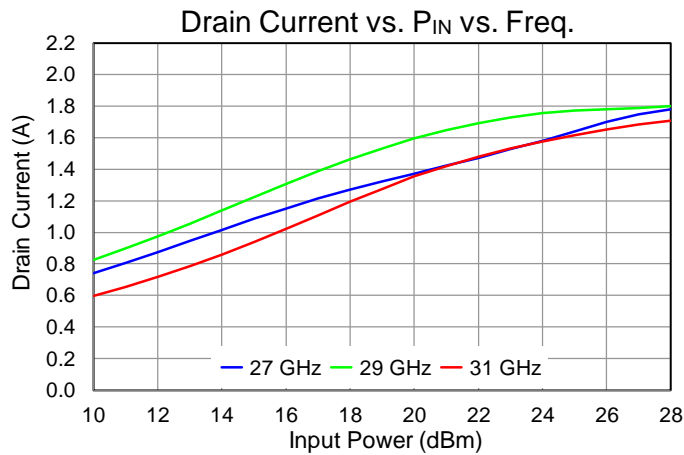
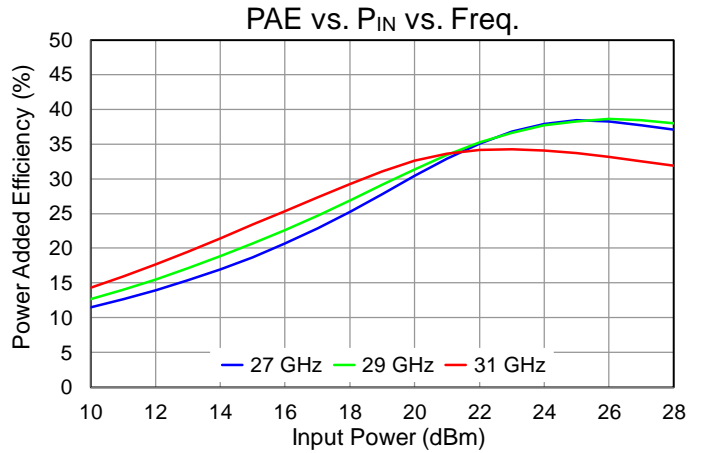
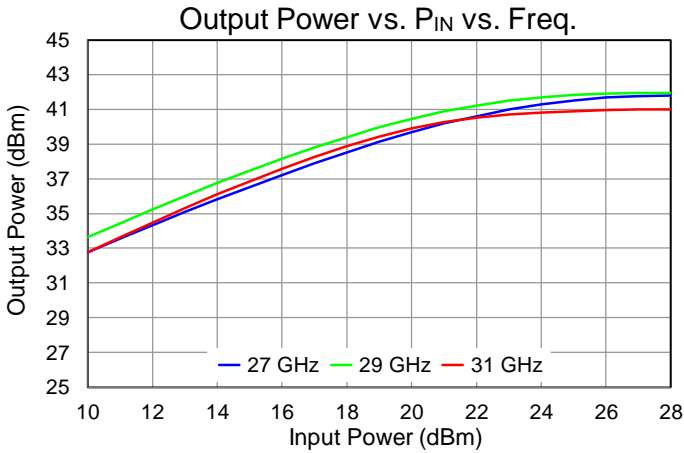

## Performance Plots – Large Signal

Test conditions, unless otherwise noted:  $V_D = 22\text{ V}$ ,  $I_{DQ} = 280\text{ mA}$ ,  $T = +25\text{ }^\circ\text{C}$   
All performance data presented is for the QPA2211D (bare die).

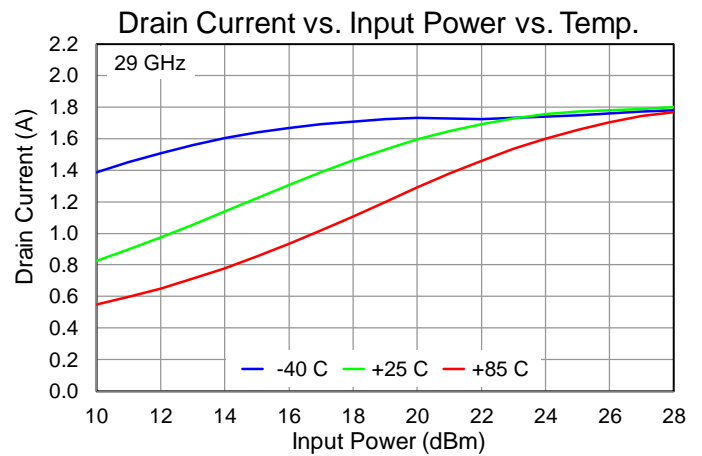
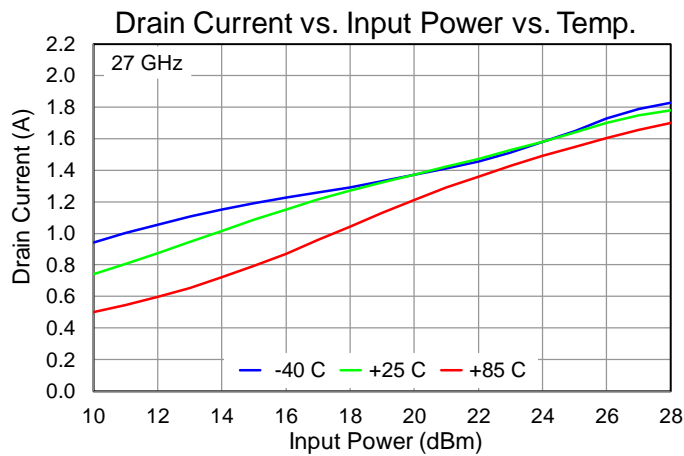
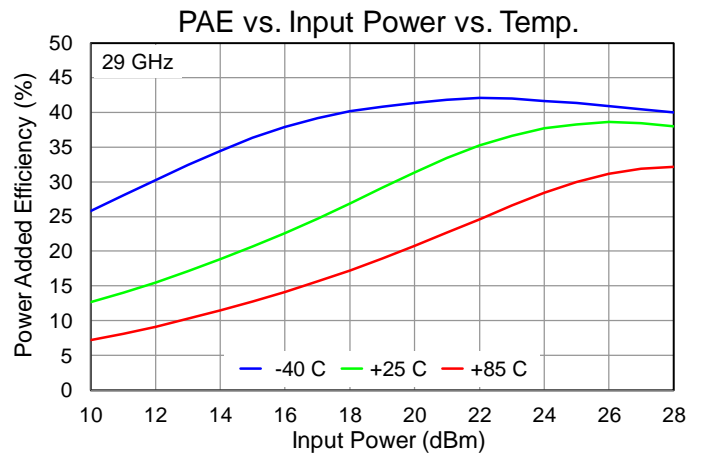
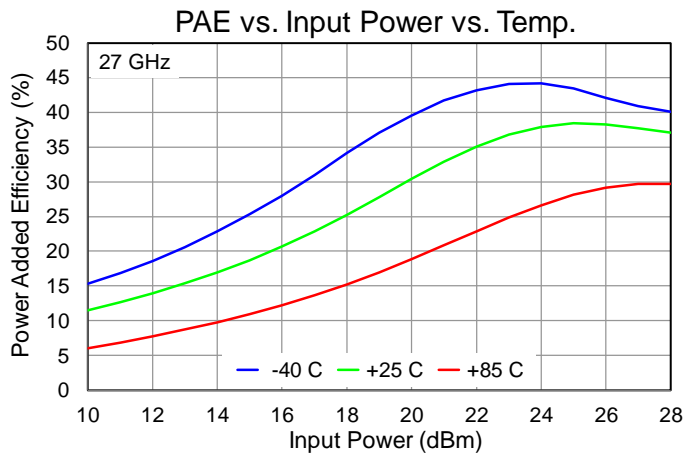
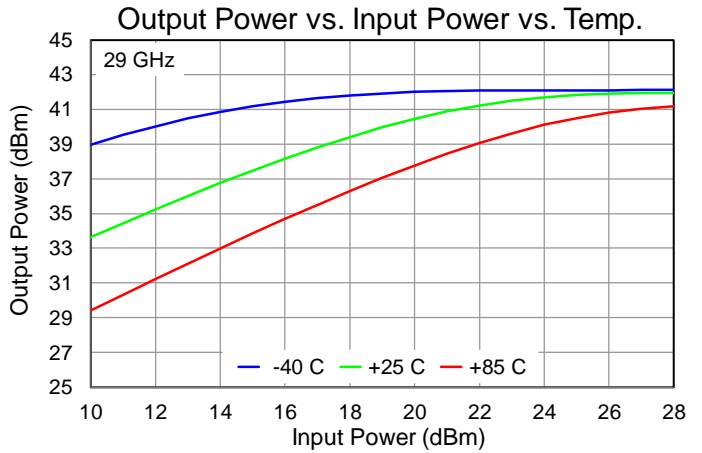
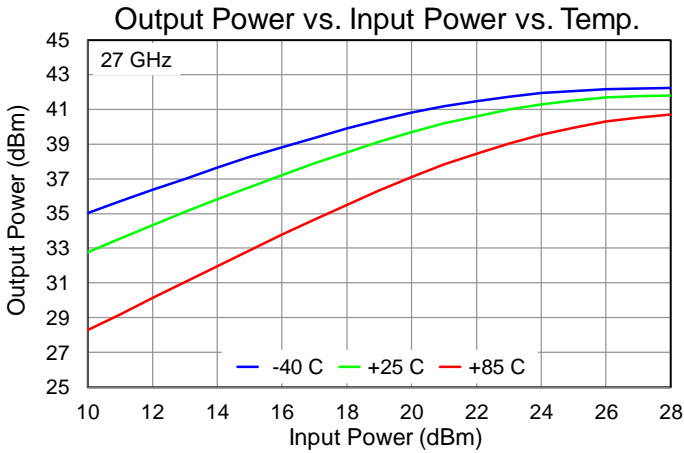

## Performance Plots – Large Signal

Test conditions, unless otherwise noted:  $V_D = 22\text{ V}$ ,  $I_{DQ} = 280\text{ mA}$ ,  $T = +25\text{ }^\circ\text{C}$   
All performance data presented is for the QPA2211D (bare die).

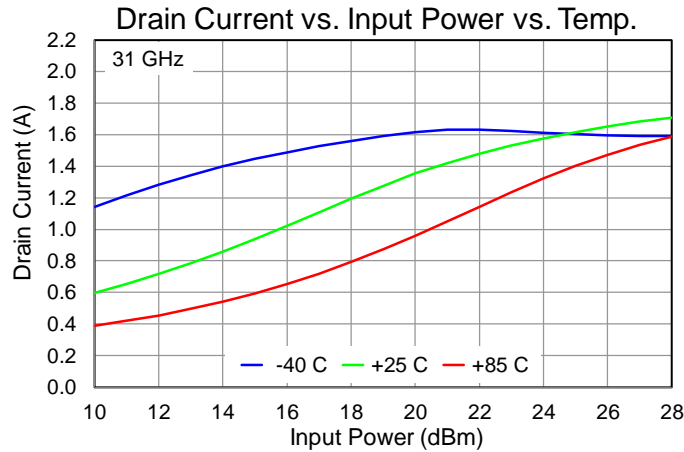
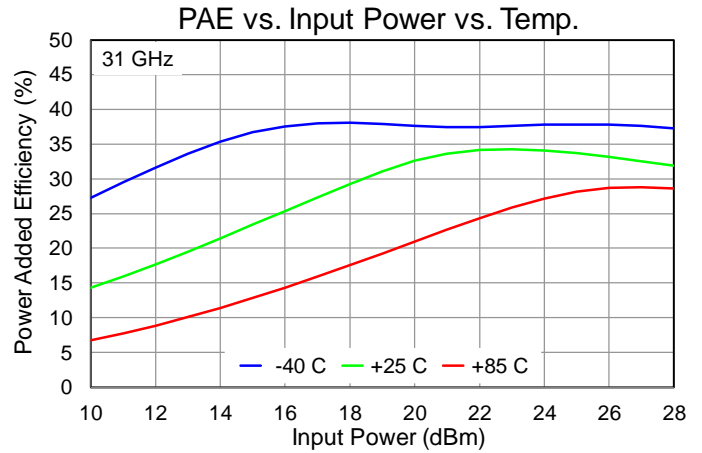
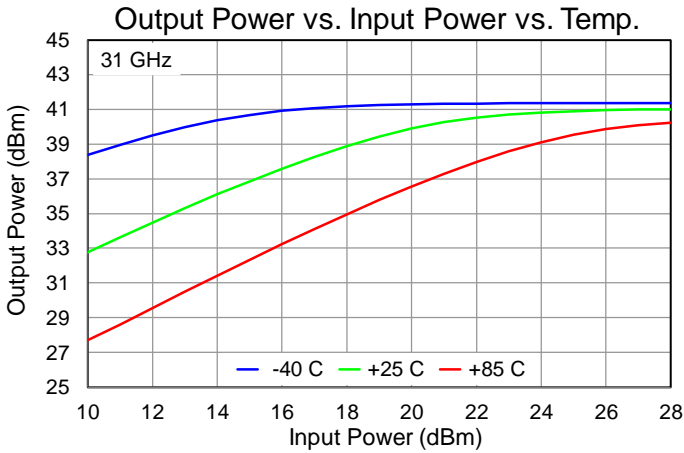

## Performance Plots – Large Signal

Test conditions, unless otherwise noted:  $V_D = 22\text{ V}$ ,  $I_{DQ} = 280\text{ mA}$ ,  $T = +25\text{ }^\circ\text{C}$   
All performance data presented is for the QPA2211D (bare die).

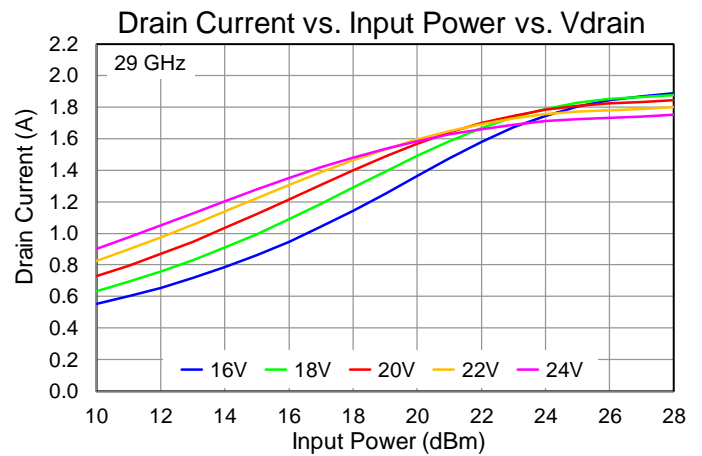
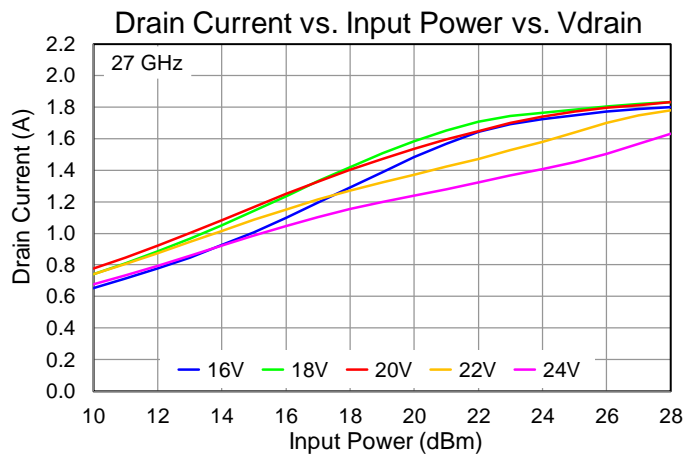
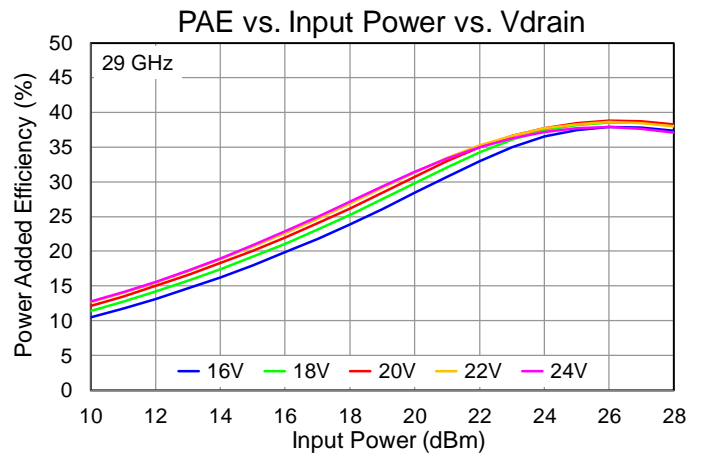
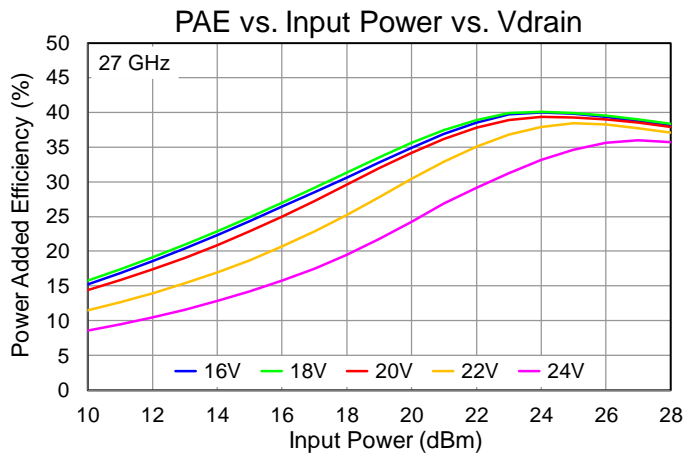
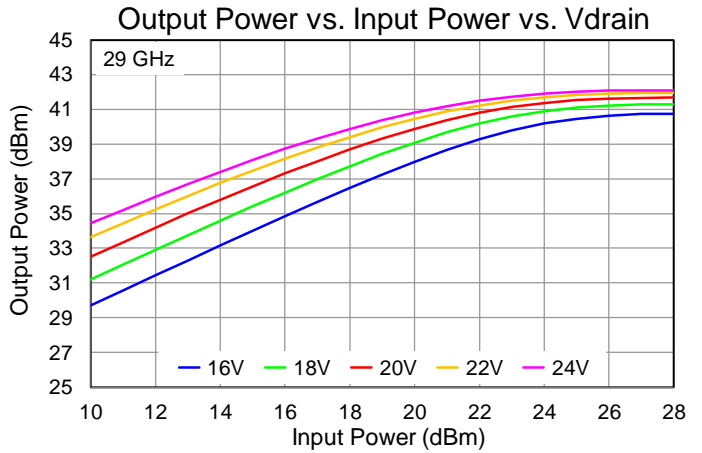
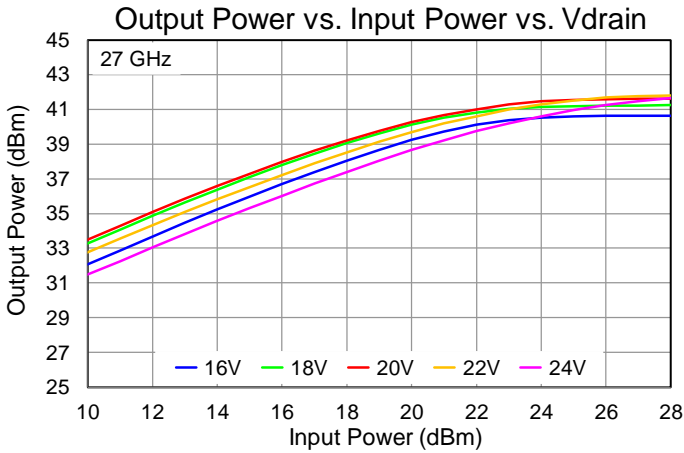

## Performance Plots – Large Signal

Test conditions, unless otherwise noted:  $V_D = 22\text{ V}$ ,  $I_{DQ} = 280\text{ mA}$ ,  $T = +25\text{ }^\circ\text{C}$   
All performance data presented is for the QPA2211D (bare die).

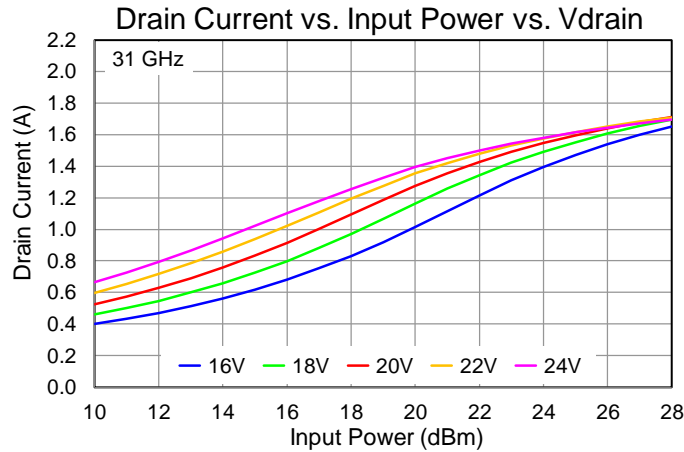
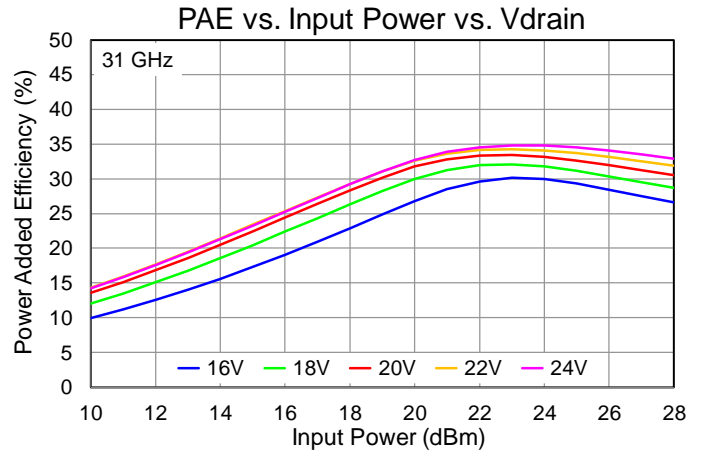
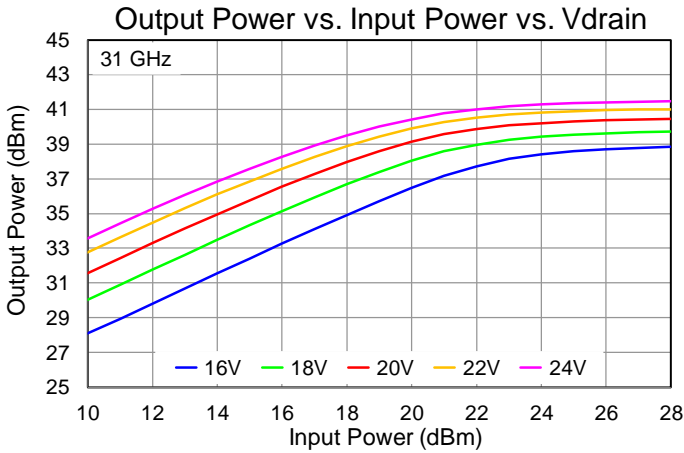

## Performance Plots – Large Signal

Test conditions, unless otherwise noted:  $V_D = 22\text{ V}$ ,  $I_{DQ} = 280\text{ mA}$ ,  $T = +25\text{ }^\circ\text{C}$   
All performance data presented is for the QPA2211D (bare die).

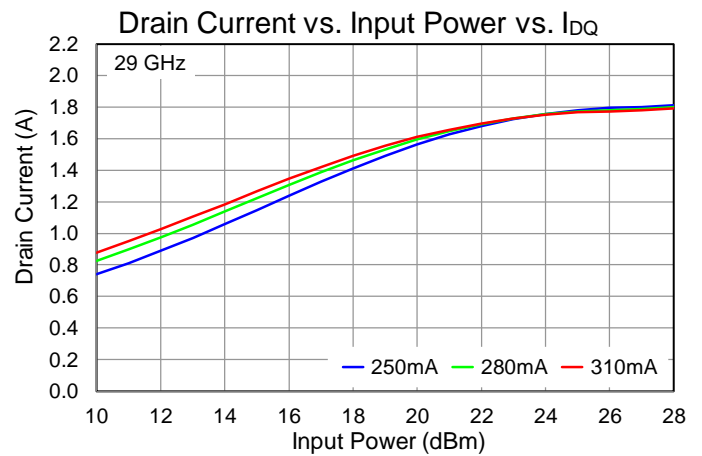
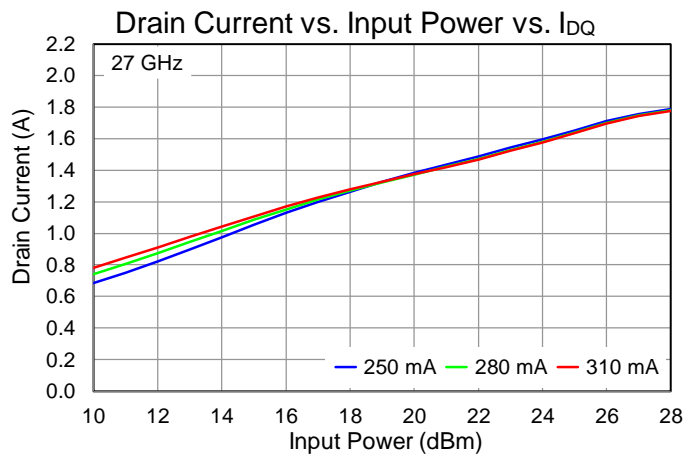
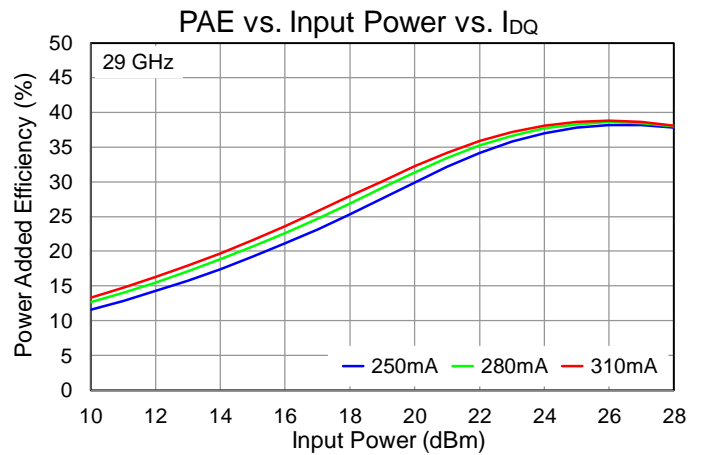
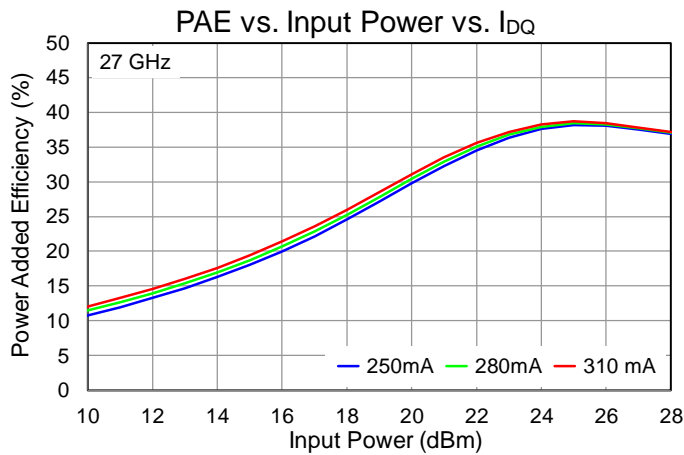
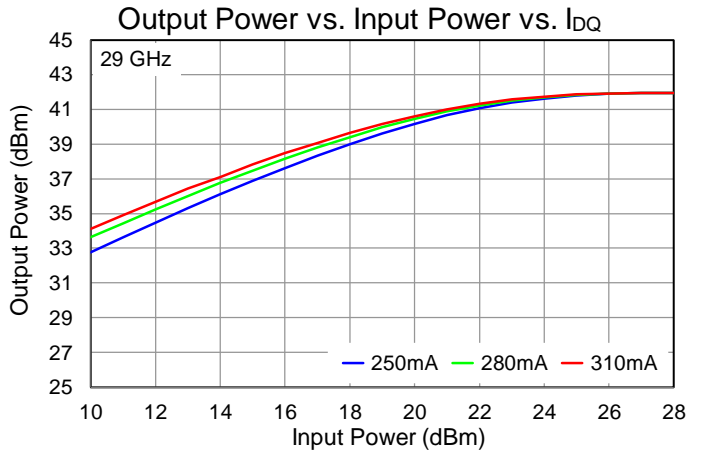
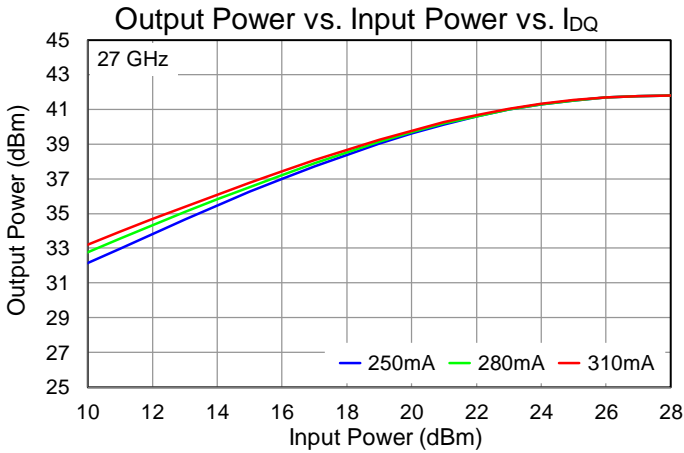

## Performance Plots – Large Signal

Test conditions, unless otherwise noted:  $V_D = 22\text{ V}$ ,  $I_{DQ} = 280\text{ mA}$ ,  $T = +25\text{ }^\circ\text{C}$   
 All performance data presented is for the QPA2211D (bare die).

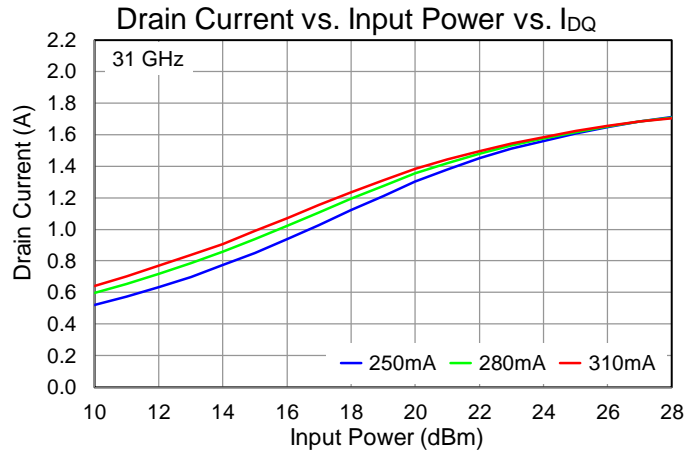
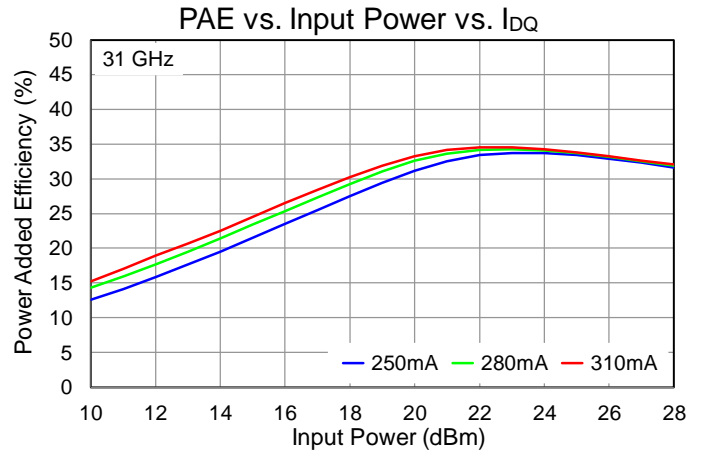
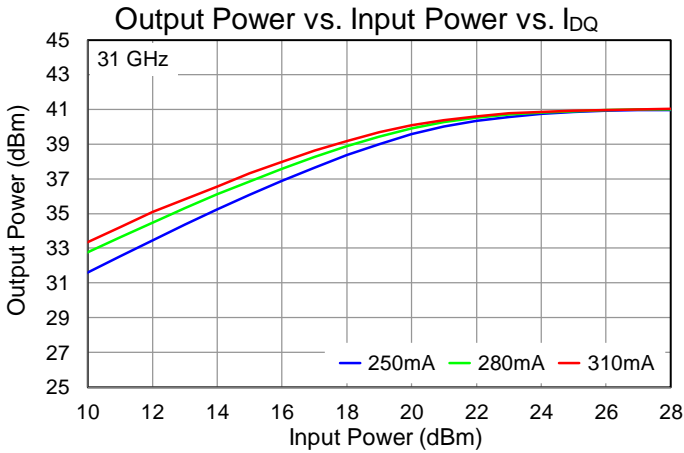

## Performance Plots – Linearity

Test conditions, unless otherwise noted:  $V_D = 22\text{ V}$ ,  $I_{DQ} = 280\text{ mA}$ ,  $T = +25\text{ }^\circ\text{C}$ , 10 MHz tone spacing  
 All performance data presented is for the QPA2211D (bare die).

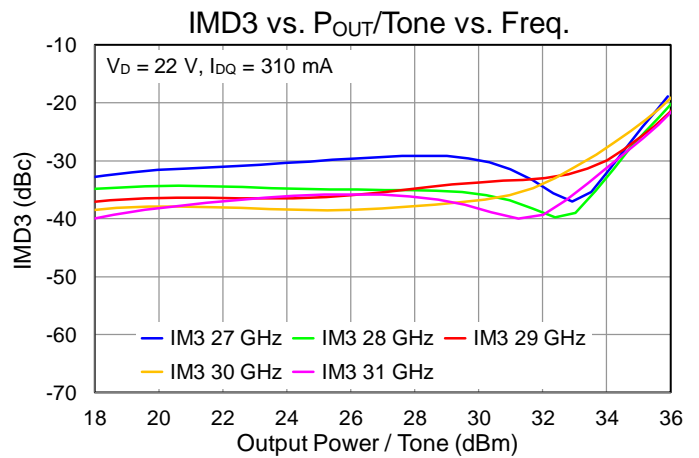
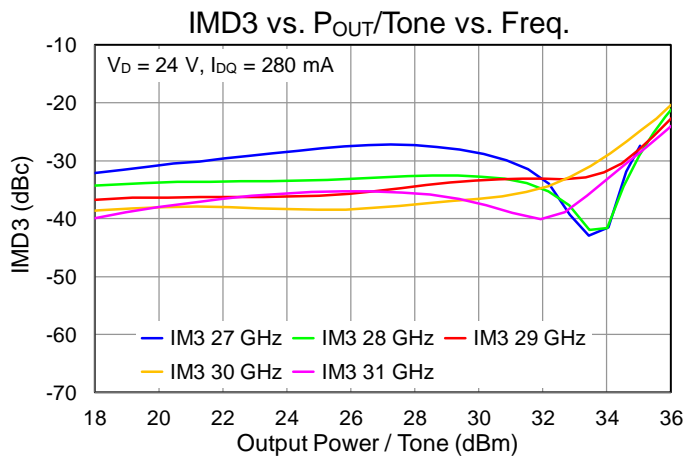
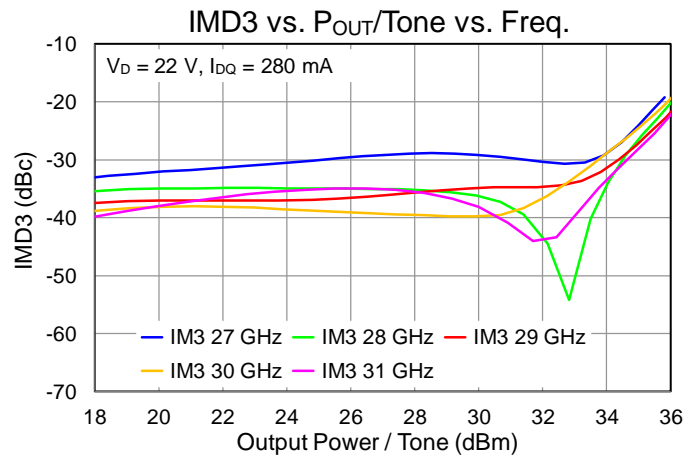
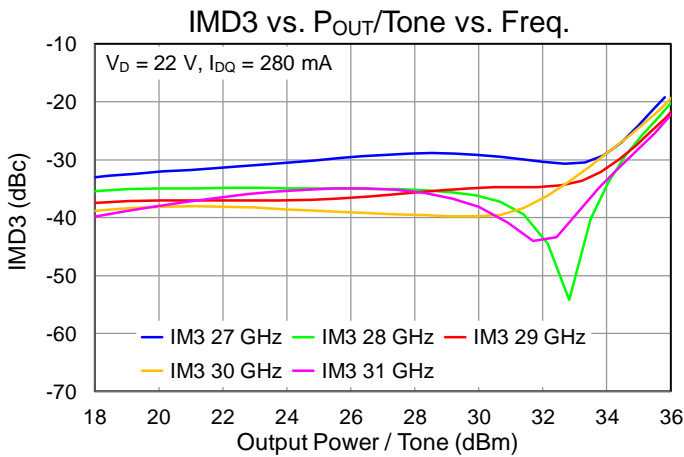
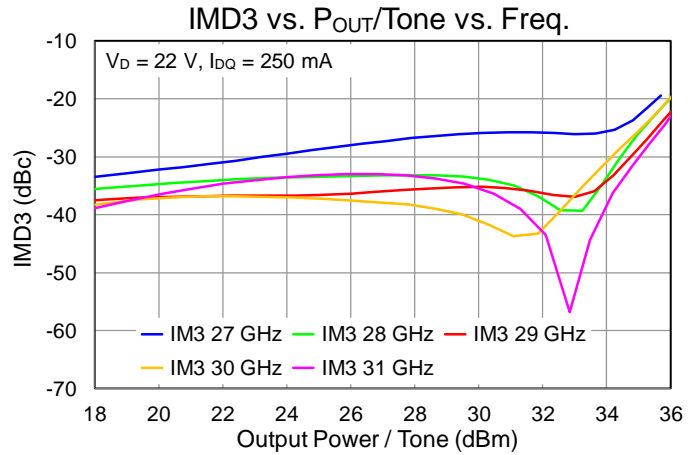
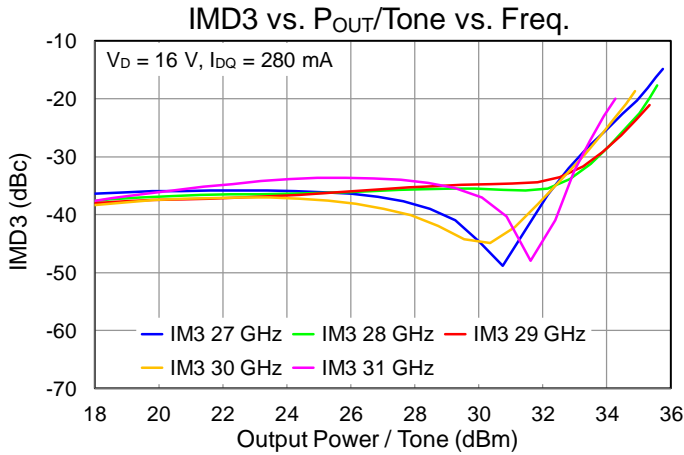

## Performance Plots – Linearity

Test conditions, unless otherwise noted:  $V_D = 22\text{ V}$ ,  $I_{DQ} = 280\text{ mA}$ ,  $T = +25\text{ }^\circ\text{C}$ , 10 MHz tone spacing  
All performance data presented is for the QPA2211D (bare die).

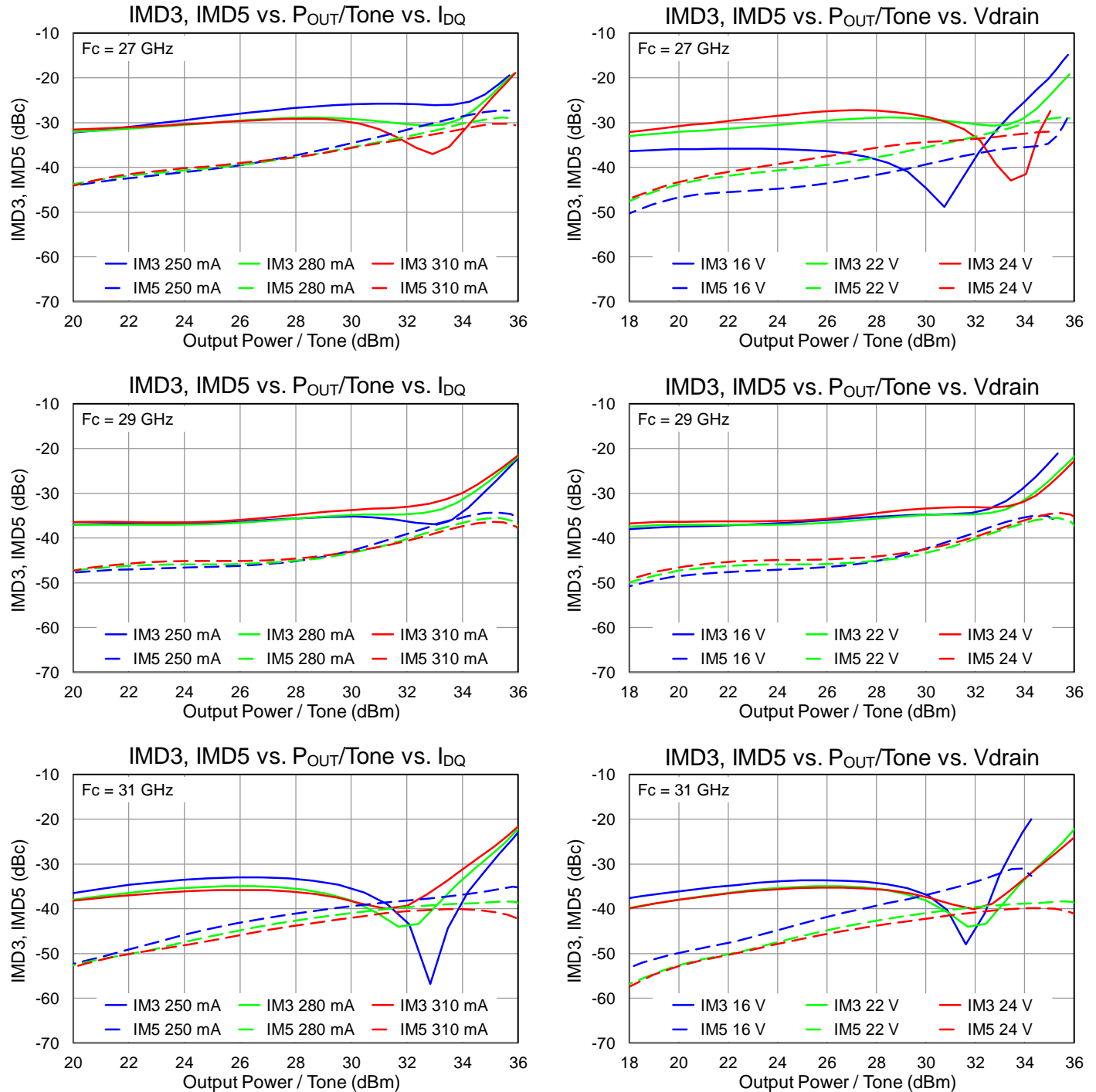

## Performance Plots – Linearity

Test conditions, unless otherwise noted:  $V_D = 22\text{ V}$ ,  $I_{DQ} = 280\text{ mA}$ ,  $T = +25\text{ }^\circ\text{C}$ , 10 MHz tone spacing  
All performance data presented is for the QPA2211D (bare die).

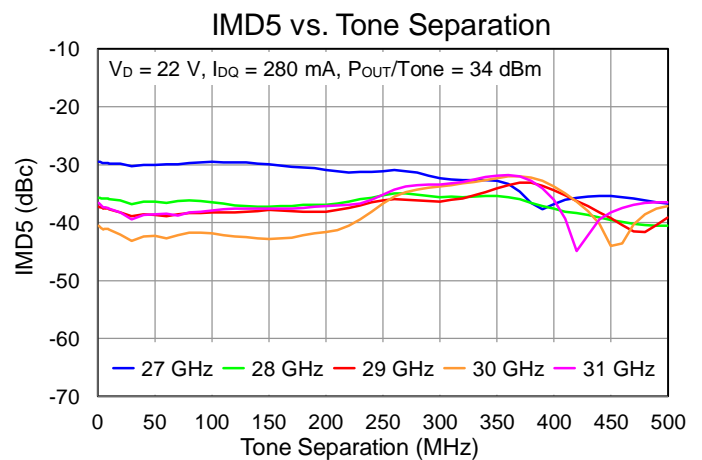
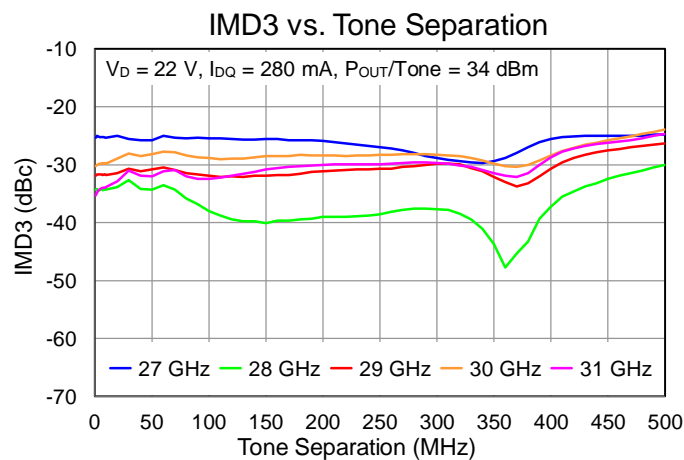
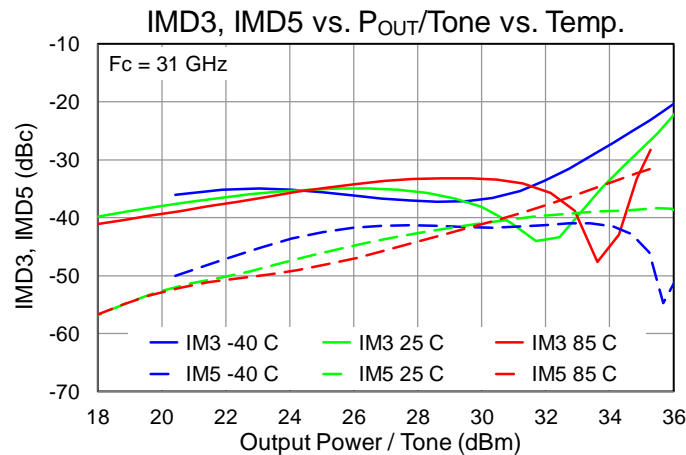
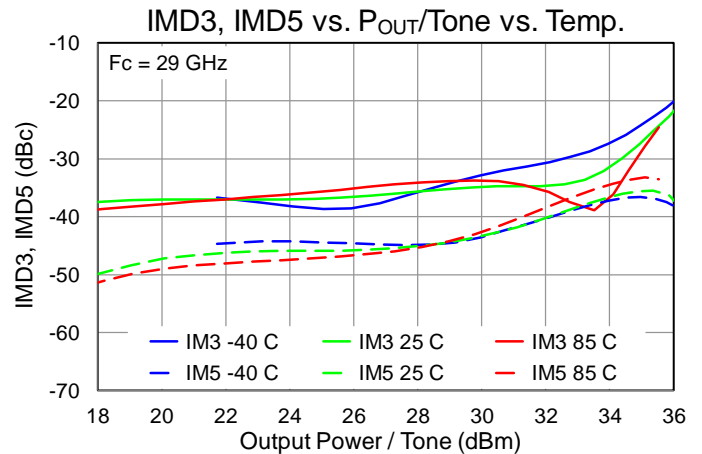
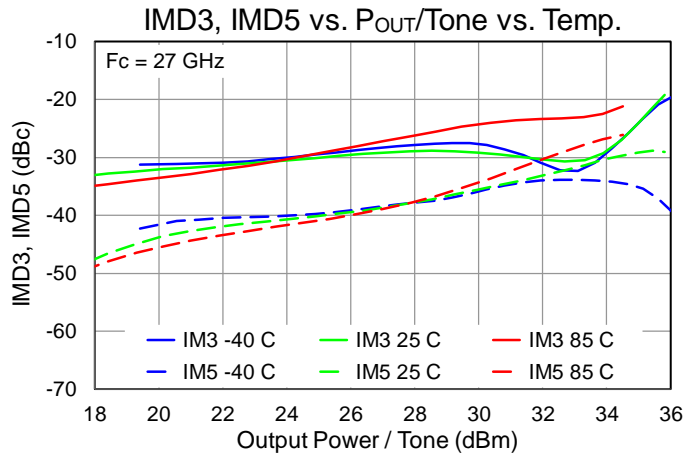

## Performance Plots – Small Signal

Test conditions, unless otherwise noted:  $V_D = 22\text{ V}$ ,  $I_{DQ} = 280\text{ mA}$ ,  $T = +25\text{ }^\circ\text{C}$   
 All performance data presented is for the QPA2211D (bare die).

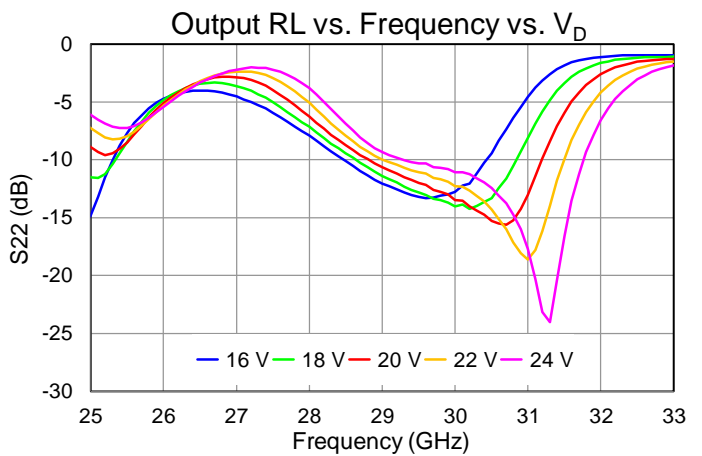
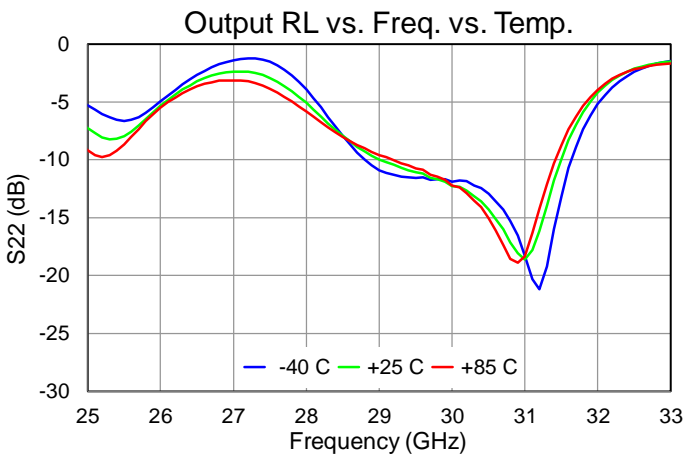
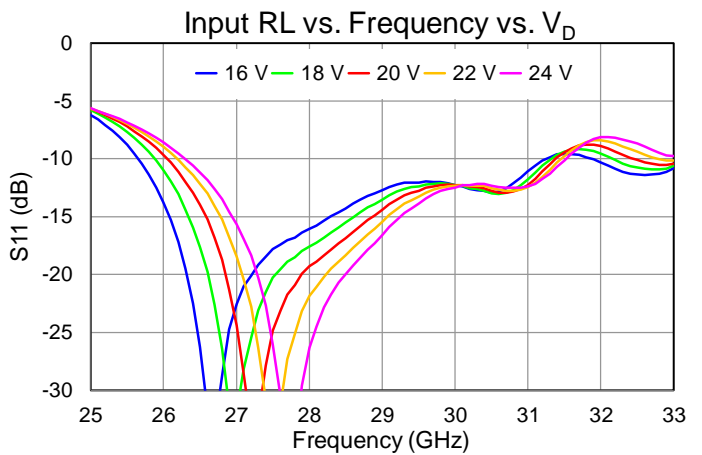
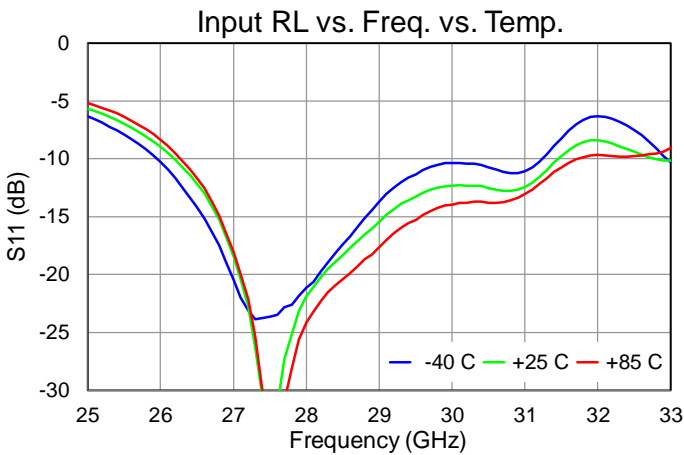
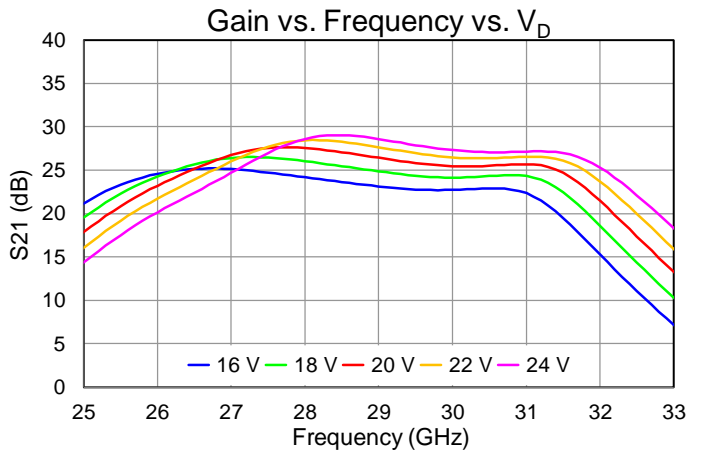
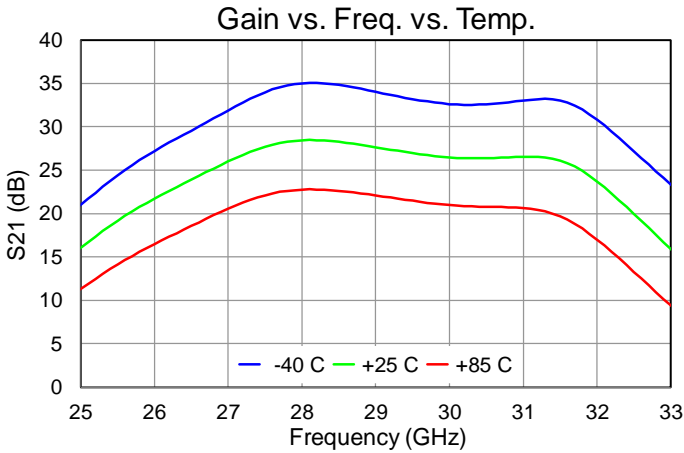

Performance Plots – Small Signal

Test conditions, unless otherwise noted:  $V_D = 22\text{ V}$ ,  $I_{DQ} = 280\text{ mA}$ ,  $T = +25\text{ }^\circ\text{C}$   
All performance data presented is for the QPA2211D (bare die).

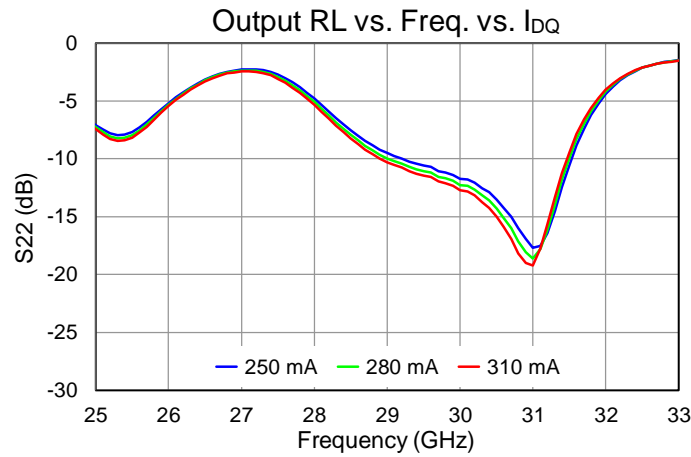
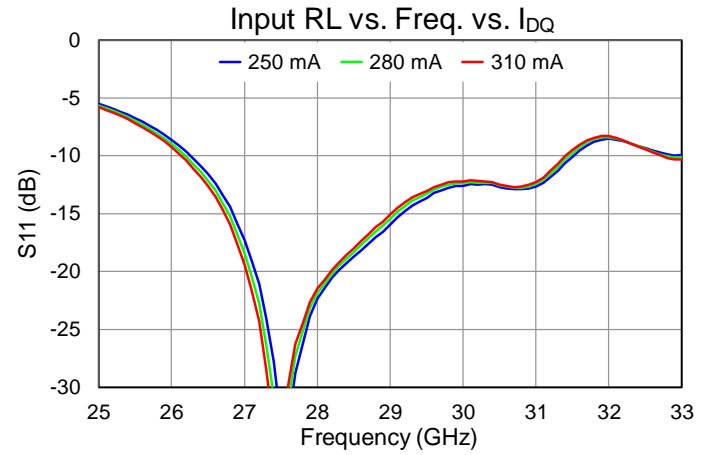
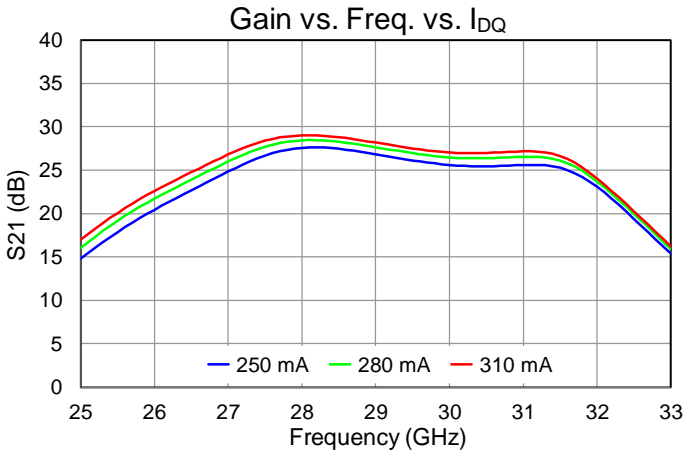

## Thermal and Reliability Information

Parameter	Test Conditions	Value	Units
Thermal Resistance ( $\theta_{JC}$ ) <sup>(1)</sup>	$T_{base} = 85\text{ }^\circ\text{C}$ , $V_D = 22\text{ V}$ , $I_{DQ} = 280\text{ mA}$ , $P_{DISS} = 6.16\text{ W}$ , No RF (quiescent DC operation)	3.24	$^\circ\text{C/W}$
Channel Temperature, $T_{CH}$ (No RF) <sup>(2)</sup>		105	$^\circ\text{C}$
Thermal Resistance ( $\theta_{JC}$ ) <sup>(1)</sup>	$T_{base} = 85\text{ }^\circ\text{C}$ , $V_D = 22\text{ V}$ , $I_{DQ} = 280\text{ mA}$ , Freq = 28.5 GHz, $I_{D\_Drive} = 1622\text{ mA}$ , $P_{IN} = 24\text{ dBm}$ , $P_{OUT} = 39.5\text{ dBm}$ , $P_{DISS} = 25.93\text{ W}$	3.74	$^\circ\text{C/W}$
Channel Temperature, $T_{CH}$ (Under RF) <sup>(2)</sup>		182	$^\circ\text{C}$
Thermal Resistance ( $\theta_{JC}$ ) <sup>(1)</sup>	$T_{base} = 85\text{ }^\circ\text{C}$ , $V_D = 24\text{ V}$ , $I_{DQ} = 280\text{ mA}$ , Freq = 28.5 GHz, $I_{D\_Drive} = 1613\text{ mA}$ , $P_{IN} = 24\text{ dBm}$ , $P_{OUT} = 40.2\text{ dBm}$ , $P_{DISS} = 28.45\text{ W}$	3.83	$^\circ\text{C/W}$
Channel Temperature, $T_{CH}$ (Under RF) <sup>(2)</sup>		194	$^\circ\text{C}$

**Notes:**

- Thermal resistance determined to the back of 20 mil CuMo carrier plate (85 °C)
- Data shown for QPA2211D (bare die) mounted onto 20 mil Cu-Mo carrier
- IR scan equivalent. Refer to the following document: [GaN Device Channel Temperature, Thermal Resistance, and Reliability Estimates](#)

## Dissipated Power and Maximum Gate Current

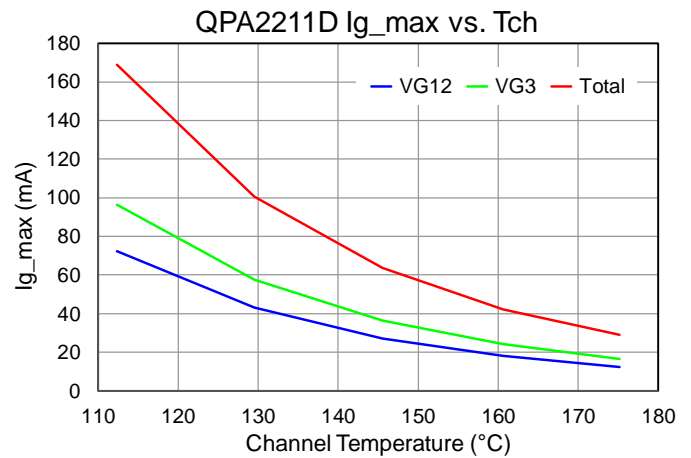
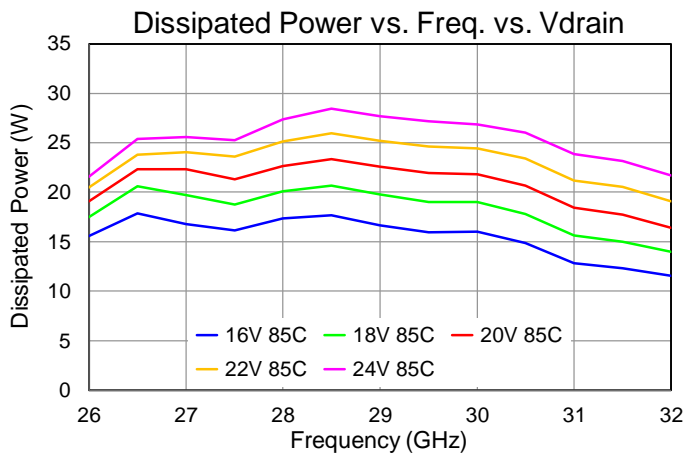

Test conditions, unless otherwise noted:  $V_D = 22\text{ V}$ ,  $I_{DQ} = 280\text{ mA}$ ,  $T = +25\text{ }^\circ\text{C}$ ,  $P_{IN} = 24\text{ dBm}$

Applications Information

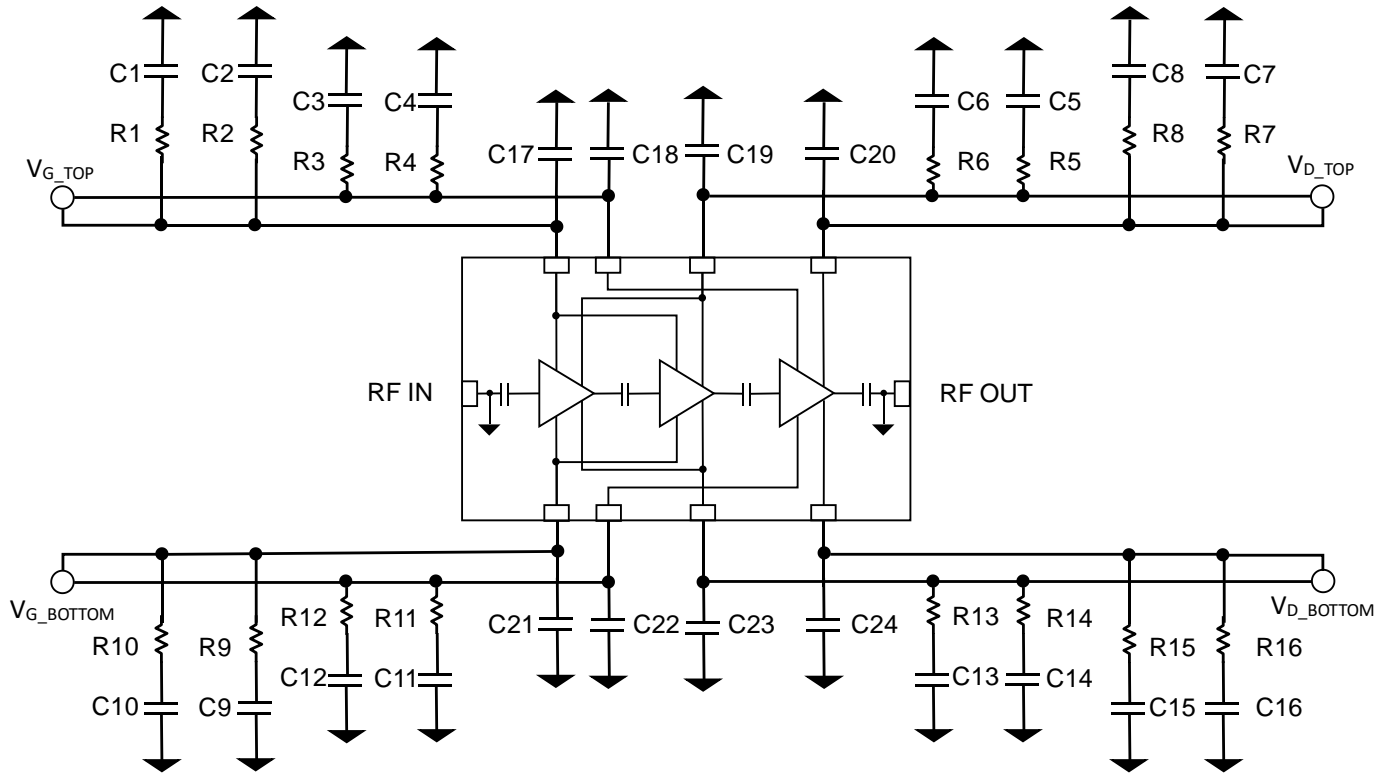

VG\_TOP and VG\_BOTTOM should be tied together  
 VD\_TOP and VD\_BOTTOM should be tied together  
 VG12 and VG3 can be separated, if desired, in an attempt to improve IMD performance.

Bill of Materials

Reference Des.	Value	Description	Manuf.	Part Number
C1,C3,C5,C7,C10,C12,C14,C16	10 uF	CAP, 10uF, 20%, 50V, 20%, X5R, 1206	Various	
C2,C4,C6,C8,C9,C11,C13,C15	0.01 uF	CAP, 0.01uF, 10%, 50V, X7R, 0402	Various	
C17,C18,C19,C20,C21,C22,C23,C24	10000 pF	CAP, 10000pF, 20%, 100V, X7R, 30X30, SL	Various	
R1,R10	5.1 Ω	RES, 5.1 OHM, 5%, 50V, 0402	Various	
R2,R4,R6,R7,R8,R9,R11,R13,R15,R16	0 Ω	RES, 0 OHM, JMPR, 0402	Various	
R3,R12	5.1 Ω	RES, 5.1 ohm, 5%,0.1W, 0603	Various	
R5,R14	0 Ω	RES, 0 ohm, 1/10W, 0603	Various	
J1, J2	2.4 mm	RF Connector, 2.4 mm	SW Microwave	1492-04A-5

Note: Schematic and components based on the EVB for the QPA2211D (bare die)

Evaluation Board (EVB) Layout Assembly

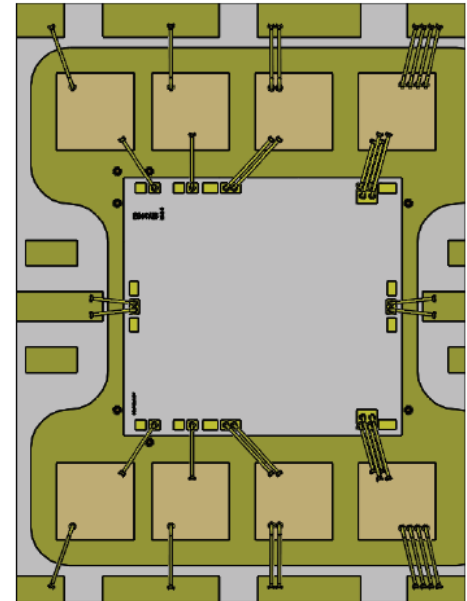
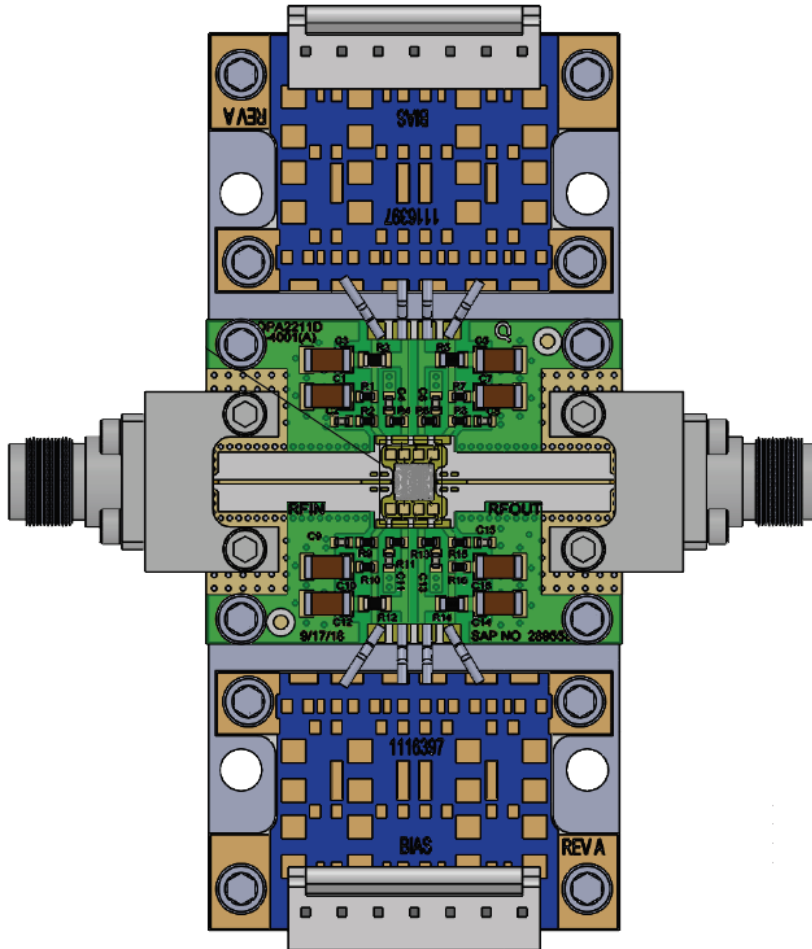

Die and capacitor placement and bonding detail

PCB is made from Rogers 6202 dielectric, .005 inch thick, 0.5 oz. copper both sides.

Note: EVB shown is for the QPA2211D; there is no EVB available for the QPA2211T.

Bias-Up Procedure

1. Set  $I_D$  limit to 3500 mA,  $I_G$  limit to 40 mA
2. Set  $V_G$  to  $-5.0$  V
3. Set  $V_D$  +22 V
4. Adjust  $V_G$  more positive until  $I_{DQ} \approx 280$  mA
5. Apply RF signal

Bias-Down Procedure

1. Turn off RF signal
2. Reduce  $V_G$  to  $-5.0$  V. Ensure  $I_{DQ} \sim 0$  mA
4. Set  $V_D$  to 0 V
5. Turn off  $V_D$  supply
6. Turn off  $V_G$  supply

Mechanical Drawing and Bond Pad Description (MMIC Only)

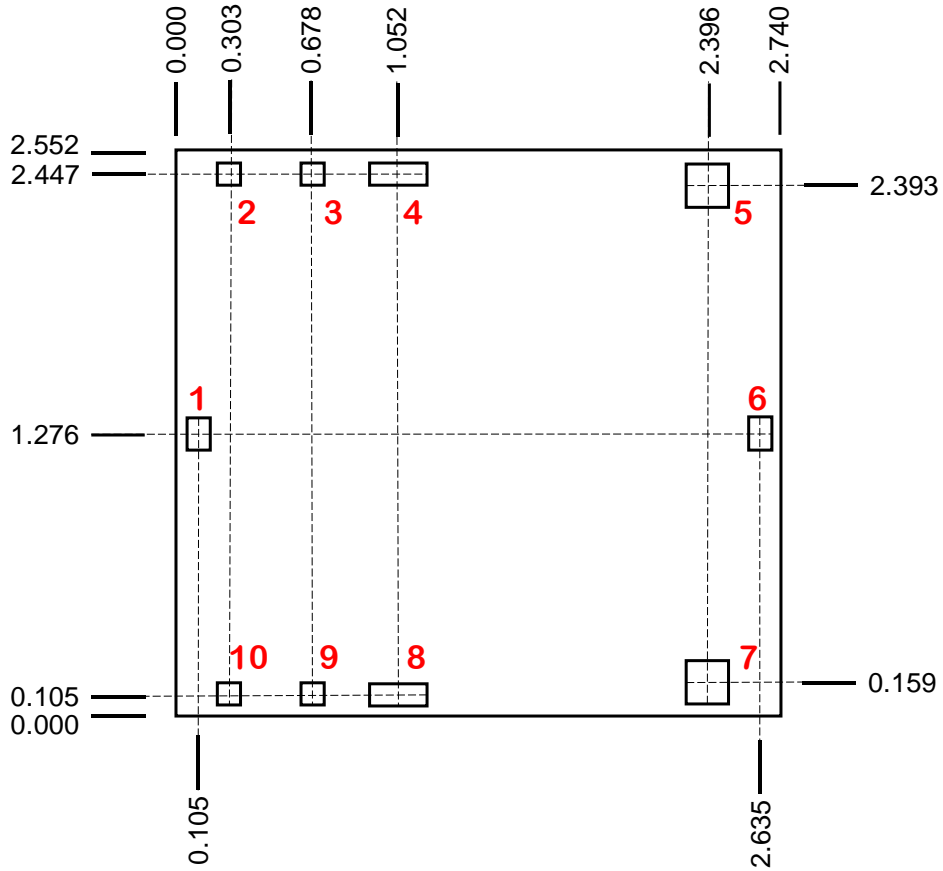

Dimensions are in mm  
Thickness: 0.050  
Die x, y size tolerance: ± 0.050  
Ground is backside of die

Bond Pad Description

Pad No.	Symbol	Size (um x um)	Description
1	RF IN	90 x 140	RF input. 50 Ohms. DC blocked; DC grounded.
2, 10	V <sub>G12</sub>	100 x 90	Gate voltage stages 1 & 2. Bypass network required; refer to page 18.
3, 9	V <sub>G3</sub>	100 x 90	Gate voltage stage3. Bypass network required; refer to page 18.
4, 8	V <sub>D12</sub>	250 x 90	Drain voltage stages 1 & 2. Bypass network required; refer to page 18.
5, 7	V <sub>D3</sub>	190 x 190	Drain voltage stage 3. Bypass network required; refer to page 18.
6	RF OUT	90 x 140	RF output. 50 Ohms. DC blocked; DC grounded.

Mechanical Drawing and Bond Pad Description (Die on Tab)

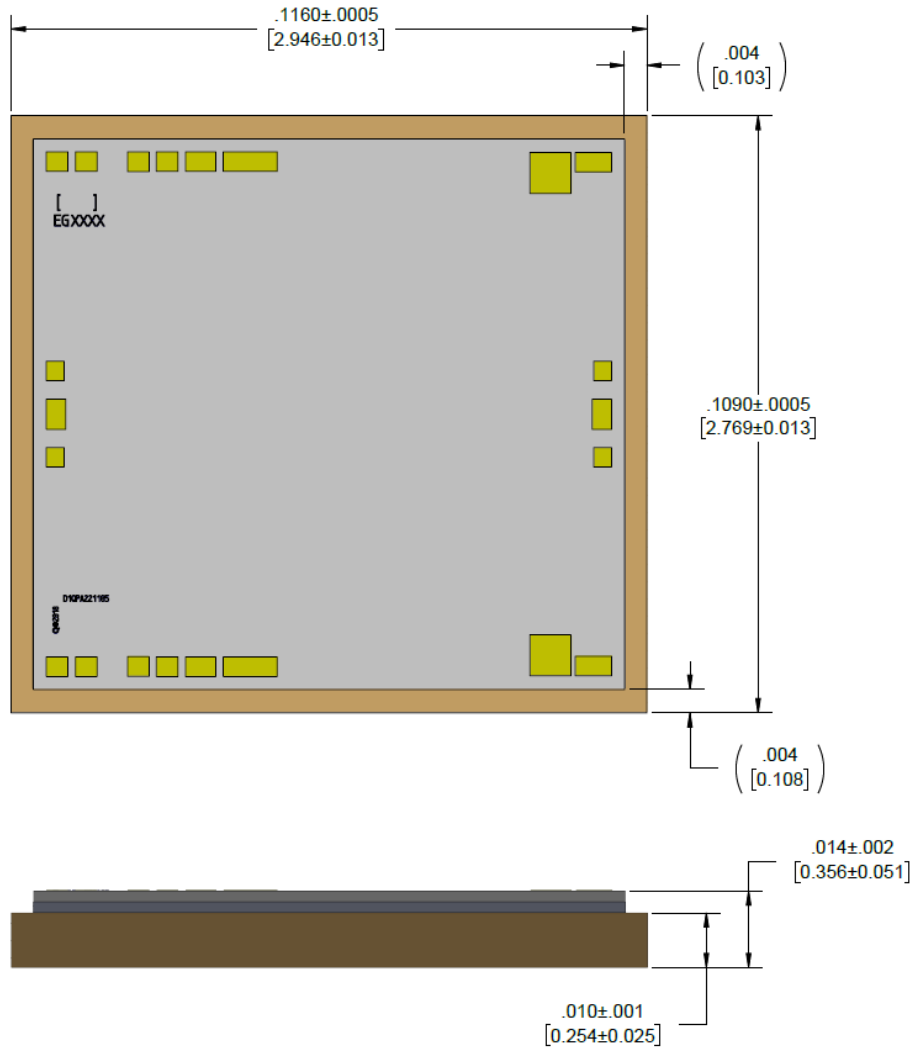

Notes:

1. Dimensions are in inches (mm)
2. Thermal spreader material: Cu-Mo-Cu
3. Plating: Gold

## Assembly Notes

---

Component placement and adhesive attachment assembly notes:

- Vacuum pencils and/or vacuum collets are the preferred method of pick up.
- Air bridges must be avoided during placement.
- The force impact is critical during auto placement.

Interconnect process assembly notes:

- Thermosonic ball bonding is the preferred interconnect technique.
- Force, time, and ultrasonic are critical parameters.
- Aluminum wire should not be used.
- Devices with small pad sizes should be bonded with 0.0007-inch wire.
- Maximum stage temperature is 200 °C.

## Handling Precautions

Parameter	Rating	Standard
ESD – Human Body Model (HBM)	1C	ANSI/ESD/JEDEC JS-001



Caution!  
 ESD-Sensitive Device

## RoHS Compliance

This part is compliant with 2011/65/EU RoHS directive (Restrictions on the Use of Certain Hazardous Substances in Electrical and Electronic Equipment) as amended by Directive 2015/863/EU.

This product also has the following attributes:

- Lead Free
- Halogen Free (Chlorine, Bromine)
- Antimony Free
- TBBP-A (C<sub>15</sub>H<sub>12</sub>Br<sub>4</sub>O<sub>2</sub>) Free
- PFOS Free
- SVHC Free

## Contact Information

For the latest specifications, additional product information, worldwide sales and distribution locations:

**Web:** [www.qorvo.com](http://www.qorvo.com)

**Tel:** 1-844-890-8163

**Email:** [customer.support@qorvo.com](mailto:customer.support@qorvo.com)

## Important Notice

The information contained herein is believed to be reliable; however, Qorvo makes no warranties regarding the information contained herein and assumes no responsibility or liability whatsoever for the use of the information contained herein. All information contained herein is subject to change without notice. Customers should obtain and verify the latest relevant information before placing orders for Qorvo products. The information contained herein or any use of such information does not grant, explicitly or implicitly, to any party any patent rights, licenses, or any other intellectual property rights, whether with regard to such information itself or anything described by such information. **THIS INFORMATION DOES NOT CONSTITUTE A WARRANTY WITH RESPECT TO THE PRODUCTS DESCRIBED HEREIN, AND QORVO HEREBY DISCLAIMS ANY AND ALL WARRANTIES WITH RESPECT TO SUCH PRODUCTS WHETHER EXPRESS OR IMPLIED BY LAW, COURSE OF DEALING, COURSE OF PERFORMANCE, USAGE OF TRADE OR OTHERWISE, INCLUDING THE IMPLIED WARRANTIES OF MERCHANTABILITY AND FITNESS FOR A PARTICULAR PURPOSE.**

Without limiting the generality of the foregoing, Qorvo products are not warranted or authorized for use as critical components in medical, life-saving, or life-sustaining applications, or other applications where a failure would reasonably be expected to cause severe personal injury or death.

© 2022 Qorvo US, Inc. All rights reserved. This document is subject to copyright laws in various jurisdictions worldwide and may not be reproduced or distributed, in whole or in part, without the express written consent of Qorvo US, Inc.

## Looking for pricing, stock, or lifecycle information?

Click below to explore more details on WIN SOURCE:

 [View QPA2211T on WIN SOURCE](#)

 [Qorvo US Inc. Information](#)

## Optimize Your Supply Chain with WIN SOURCE Solutions

-  Global Sourcing Solution
-  Obsolete Management
-  Cost Control Management
-  Shortage Management
-  Alternative Solution
-  Excess Inventory Management