

Device Features

- Gain = 15.6 dB @ 2140MHz
- OIP3 = 35.0 dBm @ 2140 MHz
- Output P1 dB = 23.2 dBm @ 2140 MHz
- N.F = 2.9dB @ 2140 MHz
- Internally matched to 50 ohms
- RoHS2-compliant SOT-89 SMT package



Product Description

The BBA02 is a BroadBand, GaAs E-pHEMT Amplifier that is ideal for applications demanding high linearity in a wideband of 40-8000 MHz. The BBA02 is internally matched to 50 Ohms and requires no external matching components. It is available in RoHS2-compliant SOT-89 SMT package. These devices are 100% DC and RF tested to assure quality and performance.

Applications

- Repeaters
- Mobile Infrastructure
- Defense/Aerospace
- LTE / WCDMA / EDGE / CDMA
- General Purpose Wireless
- IF amplifier, RF driver amplifier

Applications Circuit

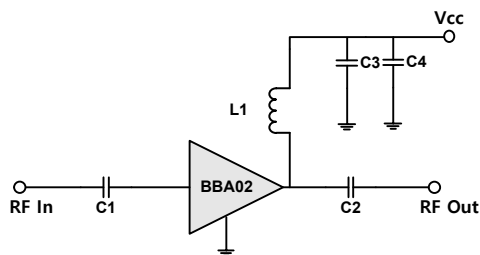

BOM @GHz	0.04~0.5	0.5~3.0	3.0~4.0	4.0~5.0	5.0~6.0
C1	1nF	100pF	10pF	10pF	10pF
C2	1nF	100pF	10pF	10pF	10pF
C3	100pF	100pF	100pF	100pF	100pF
C4	1nF	1nF	1nF	1nF	1nF
L1	470nH	39nH	15nH	8.2nH	4.7nH

Electrical Specifications

Device performance _ measured on a BeRex evaluation board at 25°C, Vd=5V, 50 Ω system.

Parameter	Conditions	Min	Typ	Max	Unit
Operational Frequency Range		40		8000	MHz
Test Frequency			2140		MHz
Gain		14.1	15.6		dB
Input Return Loss			-15.7		dB
Output Return Loss			-22.5		dB
Output IP3	5 dBm / tone , Δf=1 MHz	32.0	35.0		dBm
Output P1dB		22.2	23.2		dBm
LTE 20M ACLR*		10.5	11.5		dB
Noise Figure			2.9		dB

*ACLR Channel Power measured at -50dBc.

- LTE set-up: 3GPP LTE, FDD E-TM3.1, 20MHz BW, ±20MHz offset, PAR 9.75 at 0.01% Prob.

Recommended Operating Conditions

Parameter	Min	Typ	Max	Unit
Bandwidth	40		8000	MHz
I _d @ (V _d = 5V)	72	90	108	mA
V _d	4.75	5.0	5.25	V
dG/dT		-0.004		dB/°C
R _{TH}		53.5		°C/W
Operating Case Temperature	-40		+105	°C

Electrical specifications are measured at specified test conditions.

Specifications are not guaranteed over all recommended operating conditions.

Absolute Maximum Ratings

Parameter	Rating	Unit
Storage Temperature	-55 to +155	°C
Junction Temperature	+175	°C
Supply Voltage	+7	V
Supply Current	190	mA
Input RF Power	20	dBm

Operation of this device above any of these parameters may result in permanent damage.

Typical Performance (Vd=5V, Id=90mA, T=25°C)

Parameter	Frequency					Unit
	70	900	2140	3500	5800	MHz
Gain	17.2	16.6	15.6	14.5	13.5	dB
S11	-13.6	-17.0	-15.7	-12.5	-25.5	dB
S22	-15.8	-22.0	-22.5	-24.5	-28.0	dB
OIP3	36.5	38.0	35.0	33.0	28.5	dBm
P1dB	22.6	23.1	23.2	21.2	17.2	dBm
LTE 20M ACLR*	13.1	12.7	11.5	10.0	6.2	dBm
Noise Figure	2.8	2.4	2.9	3.2	5.2	dB

*ACLR Channel Power measured at -50dBc.

- LTE set-up: 3GPP LTE, FDD E-TM3.1, 20MHz BW, ±20MHz offset, PAR 9.75 at 0.01% Prob.

V-I Characteristics

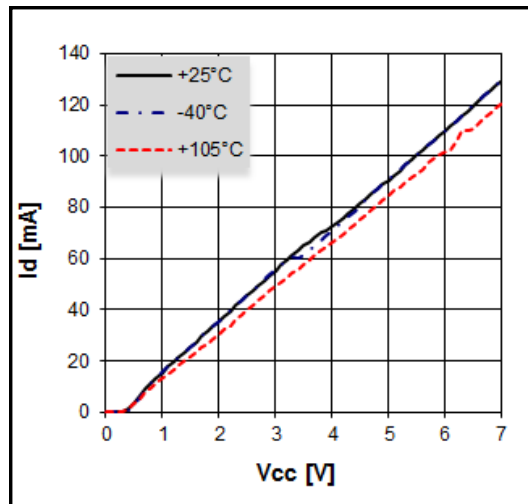

BeRex SOT89 Evaluation Board

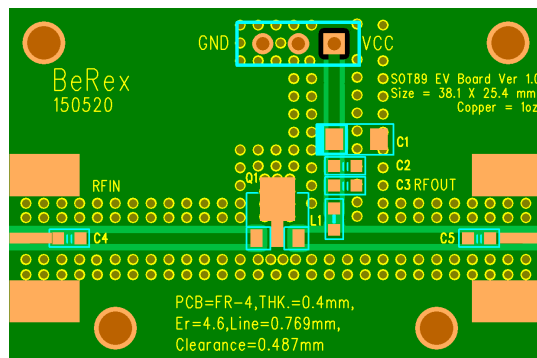

*Dielectric constant _ 4.6 *RF pattern width 0.769T *0.4T thick FR4 PCB

Typical Device Data

S-parameters (Vd=5V, Id=90mA, T=25°C)

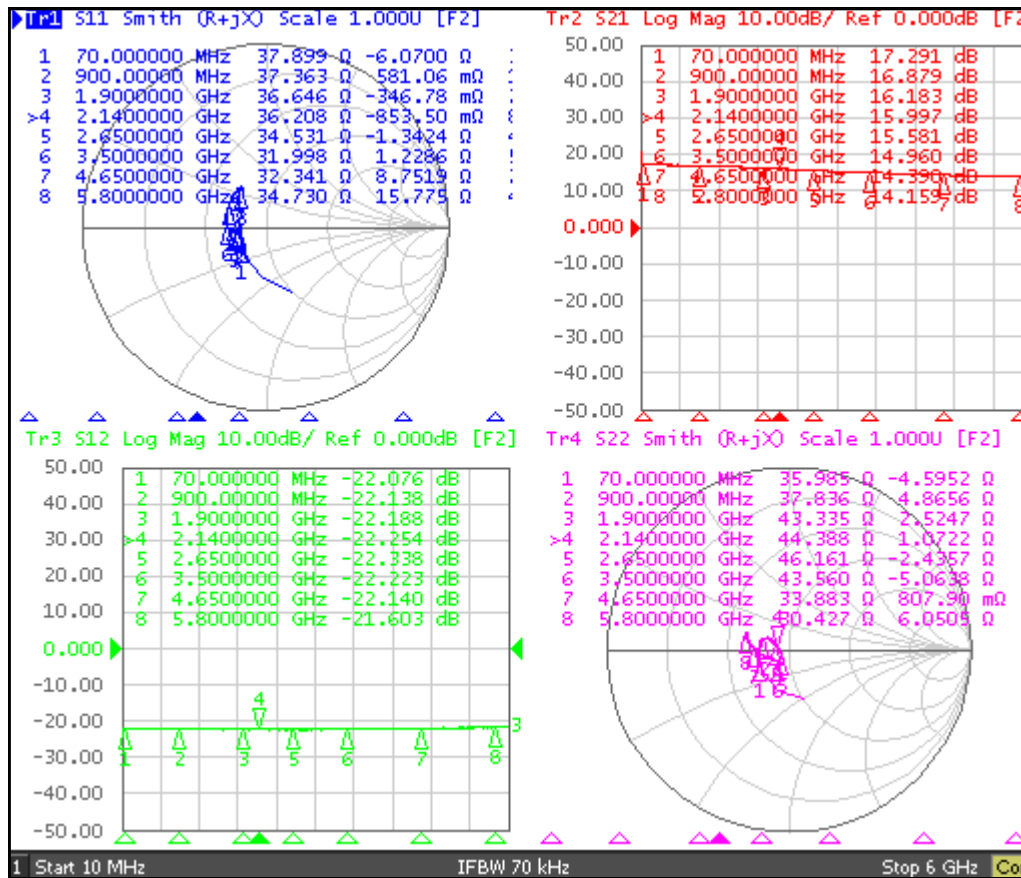

S-Parameter

(Vdevice = 5.0V, Id = 90mA, T = 25 °C, calibrated to device leads)

Freq [MHz]	S11 [Mag]	S11 [Ang]	S21 [Mag]	S21 [Ang]	S12 [Mag]	S12 [Ang]	S22 [Mag]	S22 [Ang]
200	0.14	-170.15	7.19	169.48	0.08	-1.01	0.16	-179.43
400	0.14	-177.24	7.14	162.04	0.08	-4.60	0.16	169.63
1200	0.15	177.44	6.84	131.10	0.08	-18.57	0.13	151.36
2000	0.16	-177.38	6.39	99.93	0.08	-30.82	0.07	161.01
2800	0.19	-174.95	5.93	70.39	0.08	-45.17	0.05	-136.86
3600	0.22	172.96	5.55	42.51	0.08	-59.71	0.09	-142.84
4400	0.23	153.33	5.35	14.14	0.08	-75.21	0.17	-175.54
5200	0.25	134.61	5.04	-14.02	0.08	-94.68	0.23	164.59
6000	0.25	119.61	5.12	-44.81	0.08	-120.32	0.25	157.47

Application Circuit: 70 MHz

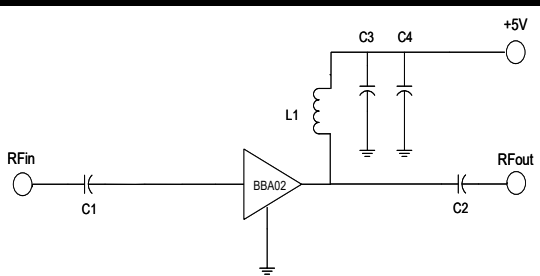
Schematic Diagram	BOM	Tolerance
	C1	1nF ± 5%
	C2	1nF ± 5%
	C3	100pF ± 5%
	C4	1nF ± 5%
	L1	470nH ± 5%

Typical Performance

(Vd=5V, Id=90mA, T=25°C)

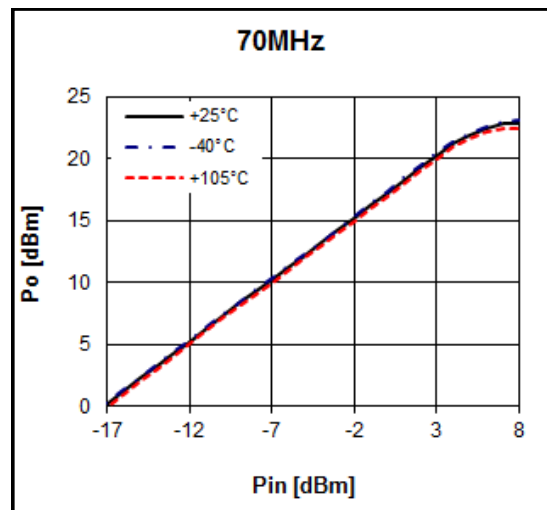
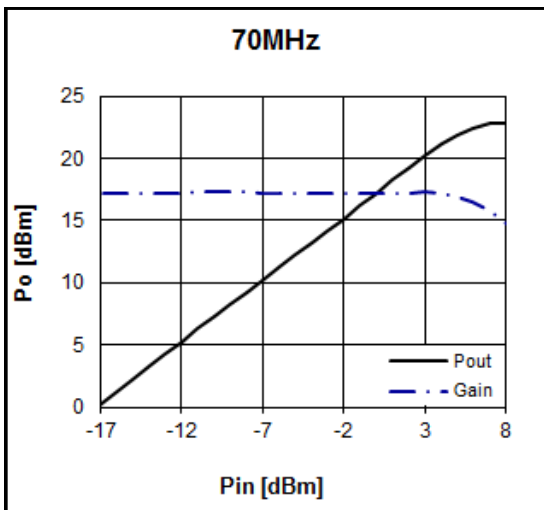

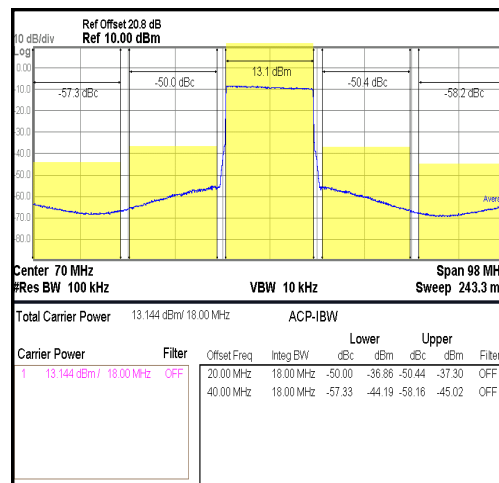
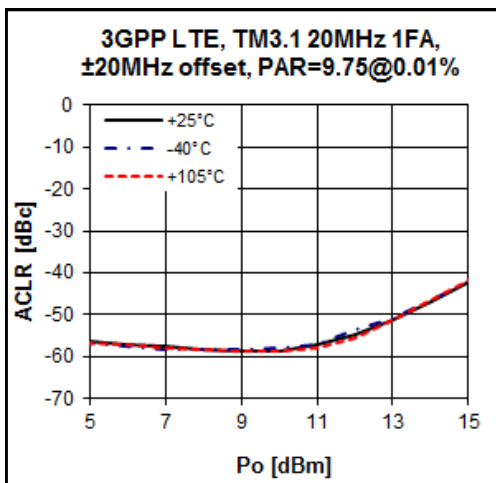
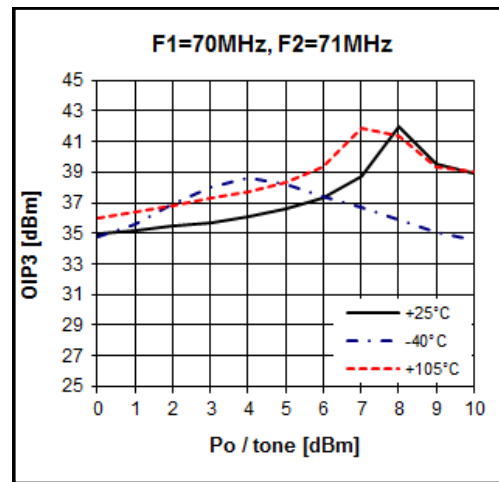
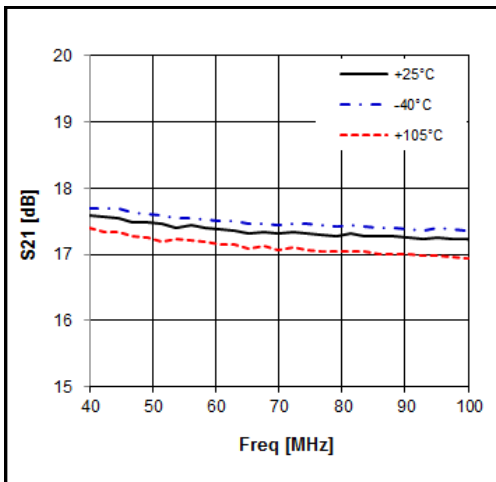
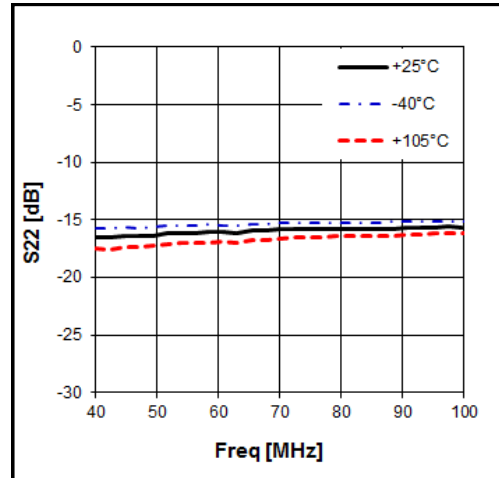
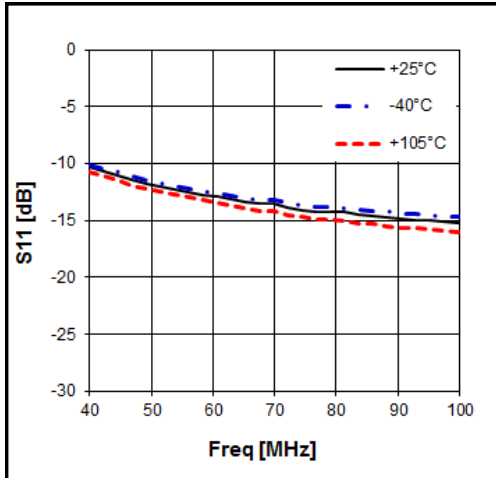

Application Circuit: 900 MHz

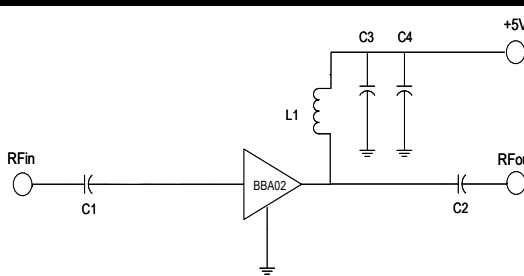
Schematic Diagram	BOM	Tolerance	
	C1	100pF	± 5%
	C2	100pF	± 5%
	C3	100pF	± 5%
	C4	1nF	± 5%
	L1	39nH	± 5%

Typical Performance

(Vd=5V, Id=90mA, T=25°C)

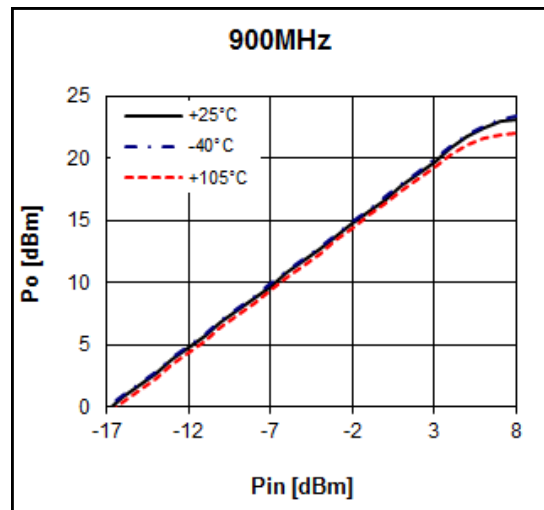
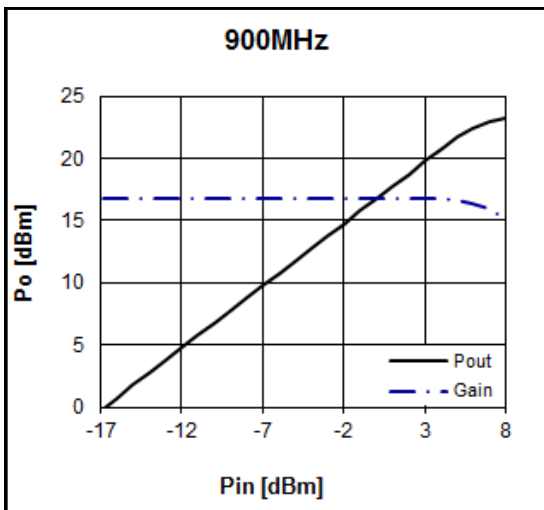

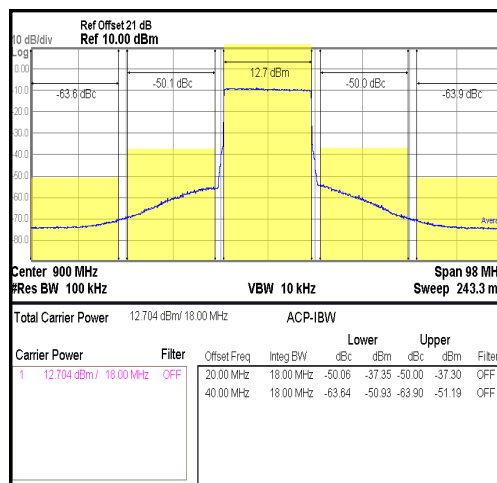
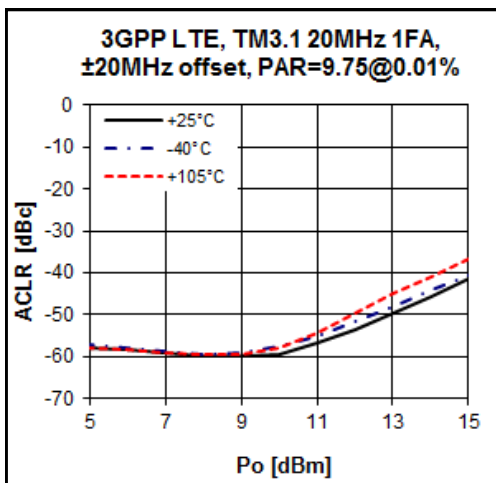
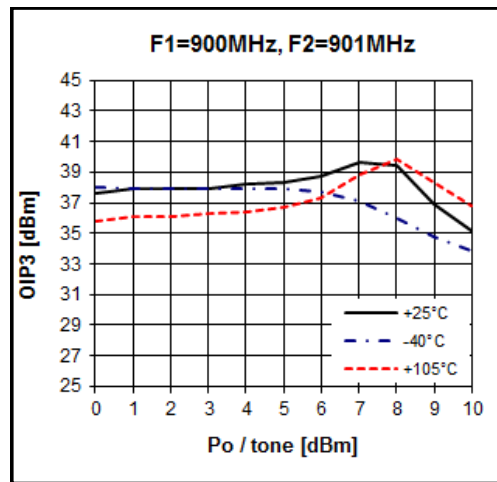
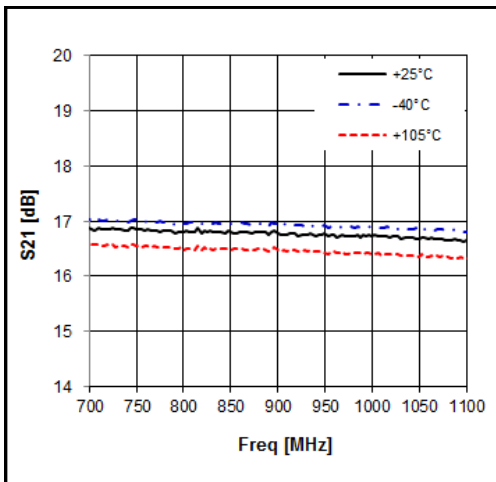
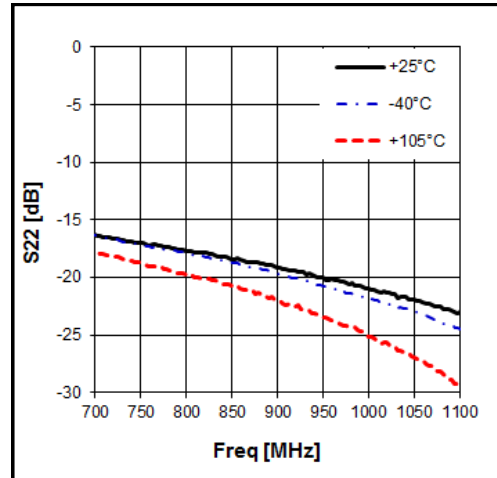
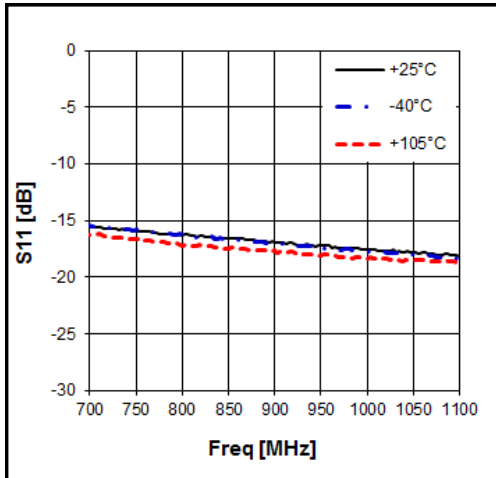

Application Circuit: 1900 MHz

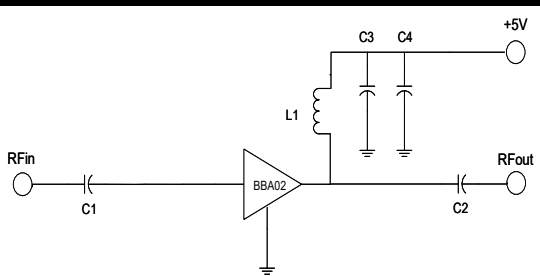
Schematic Diagram	BOM		Tolerance
	C1	100pF	± 5%
	C2	100pF	± 5%
	C3	100pF	± 5%
	C4	1nF	± 5%
	L1	39nH	± 5%

Typical Performance

(Vd=5V, Id=90mA, T=25°C)

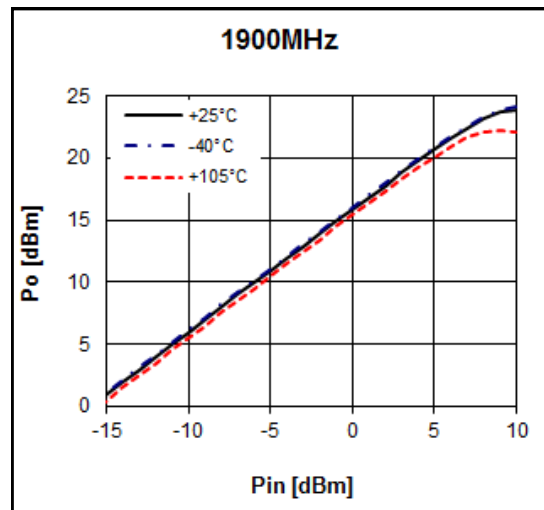
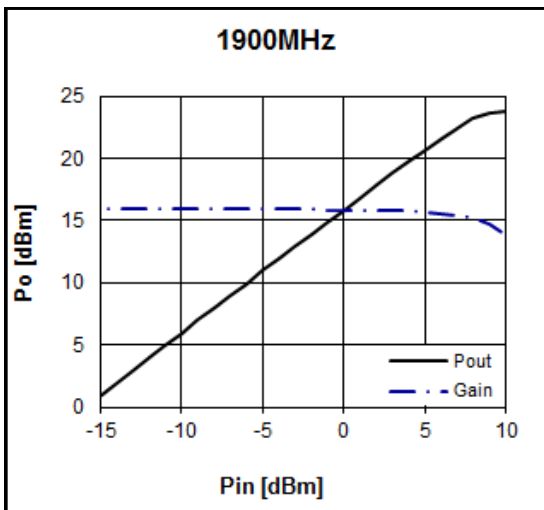

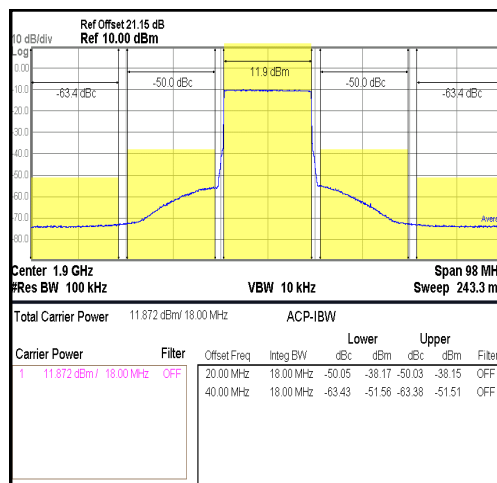
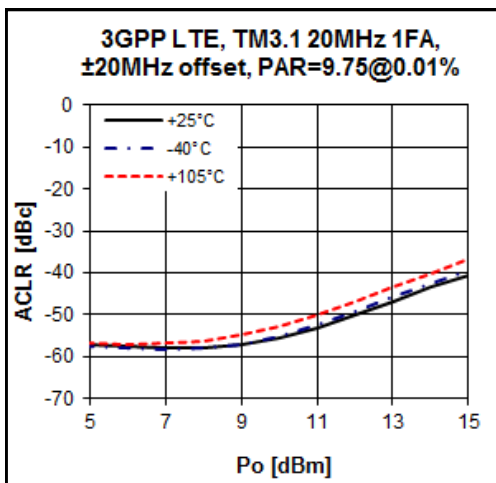
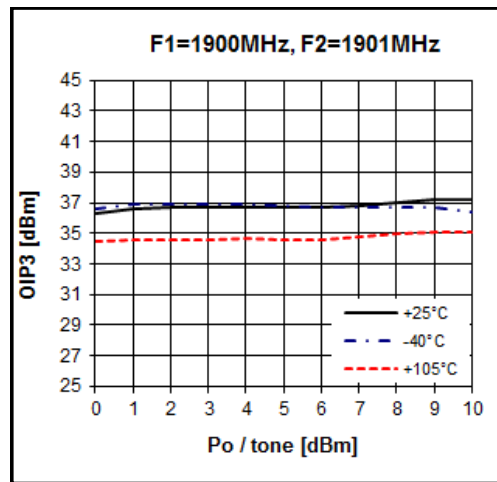
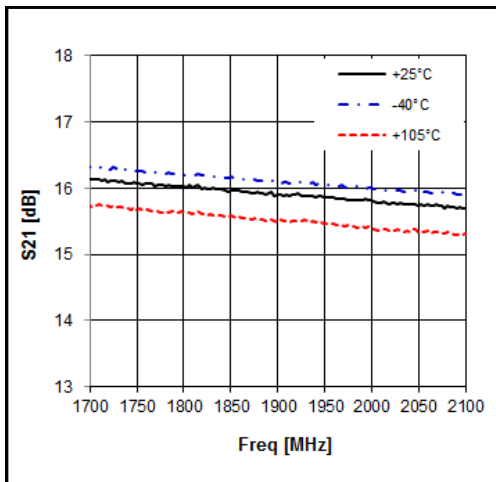
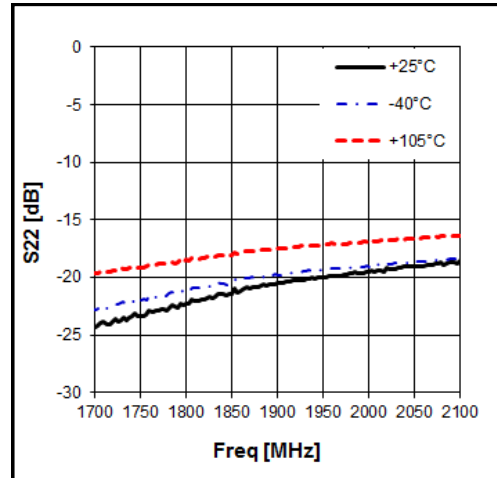
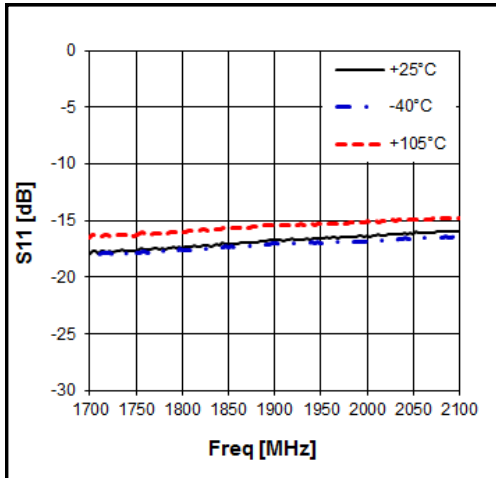

Application Circuit: 2140 MHz

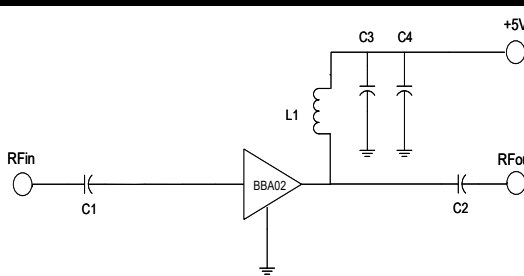
Schematic Diagram		BOM		Tolerance
		C1	100pF	± 5%
		C2	100pF	± 5%
		C3	100pF	± 5%
		C4	1nF	± 5%
		L1	39nH	± 5%

Typical Performance

(Vd=5V, Id=90mA, T=25°C)

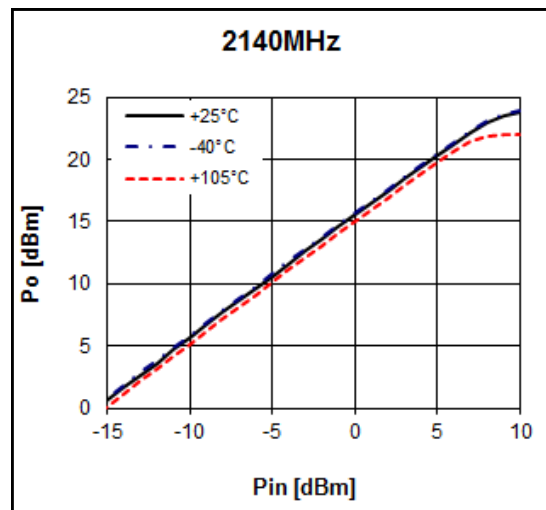
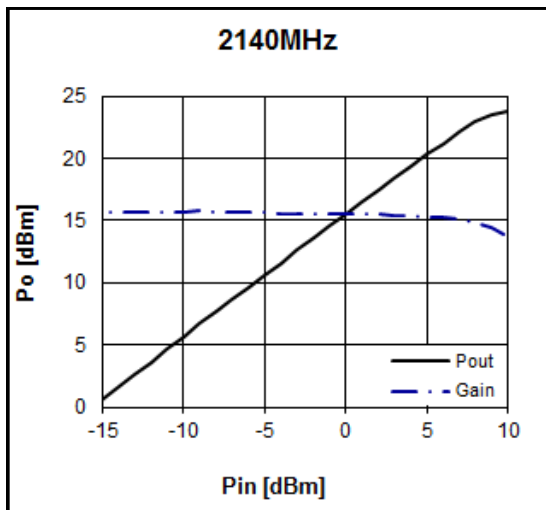

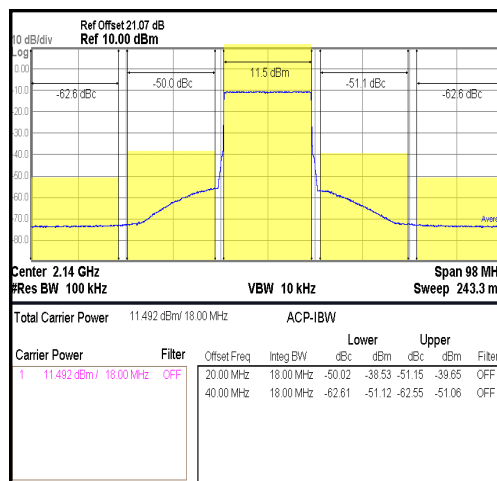
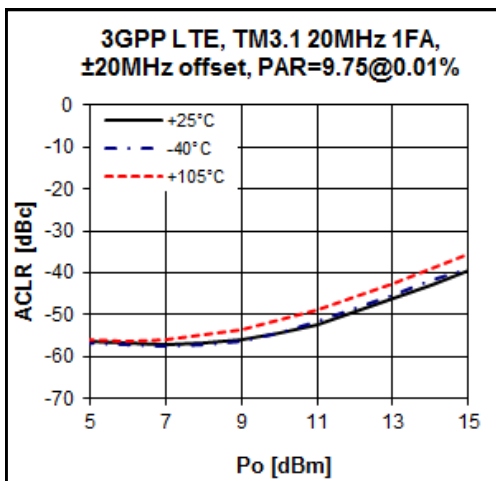
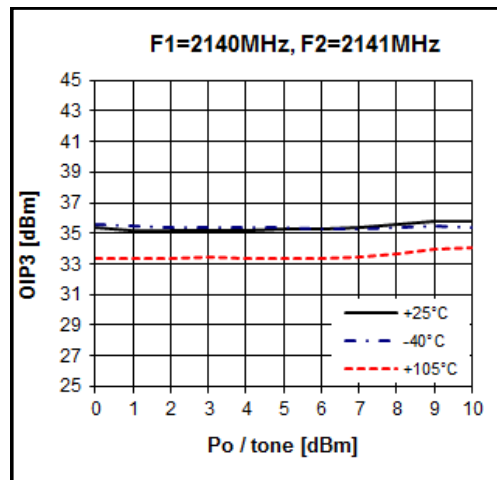
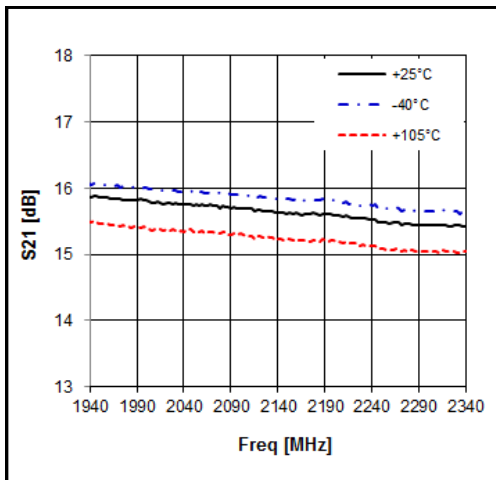
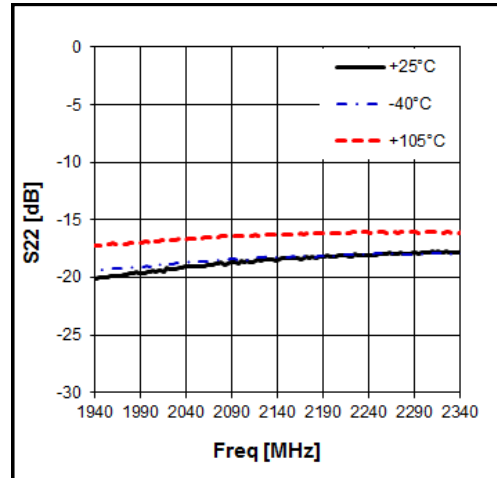
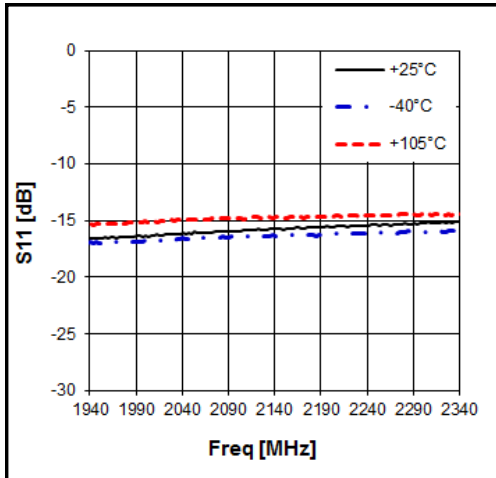

Application Circuit: 2650 MHz

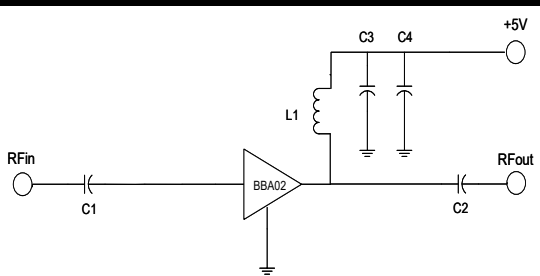
Schematic Diagram		BOM		Tolerance
		C1	100pF	± 5%
		C2	100pF	± 5%
		C3	100pF	± 5%
		C4	1nF	± 5%
		L1	39nH	± 5%

Typical Performance

(Vd=5V, Id=90mA, T=25°C)

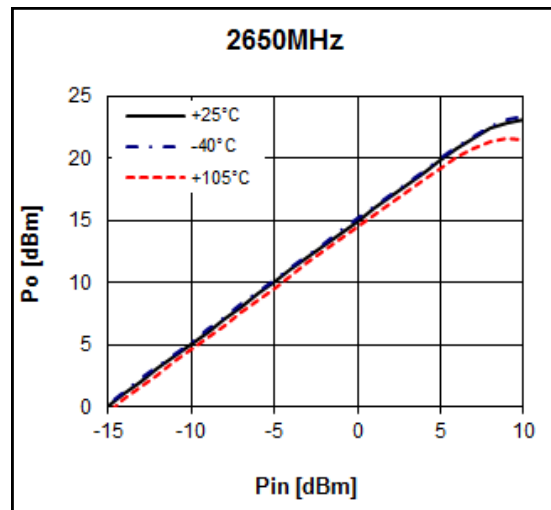
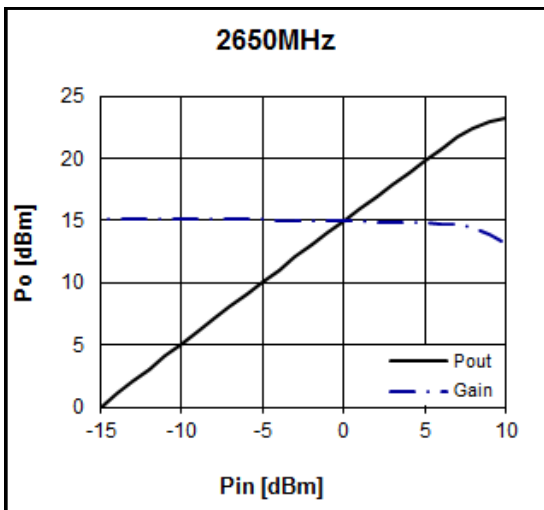

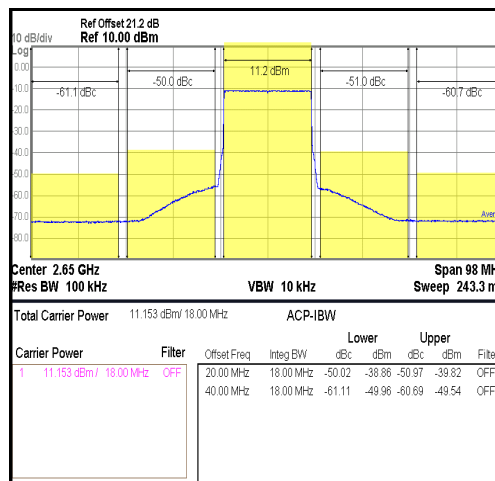
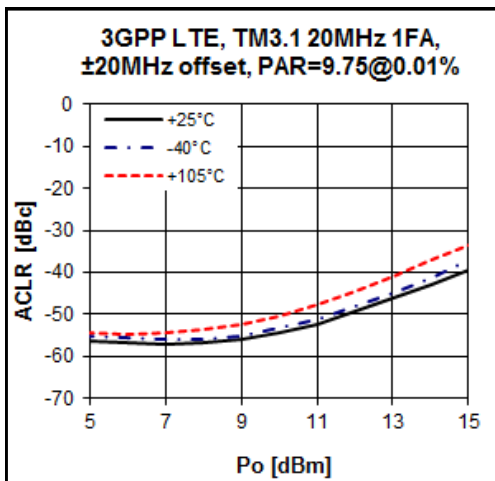
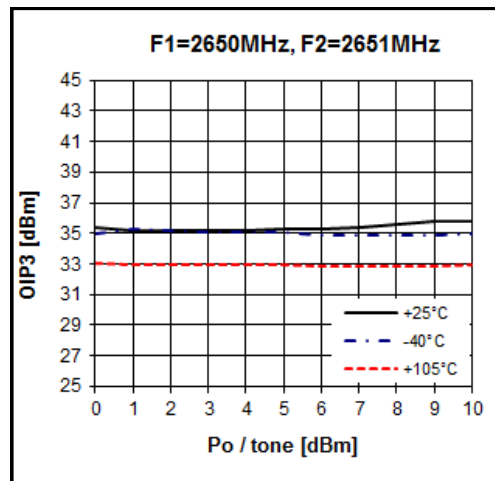
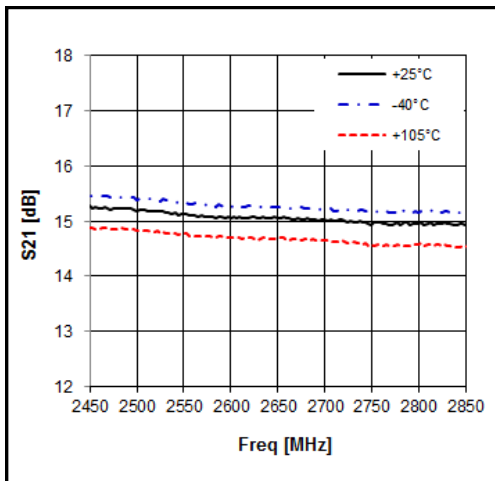
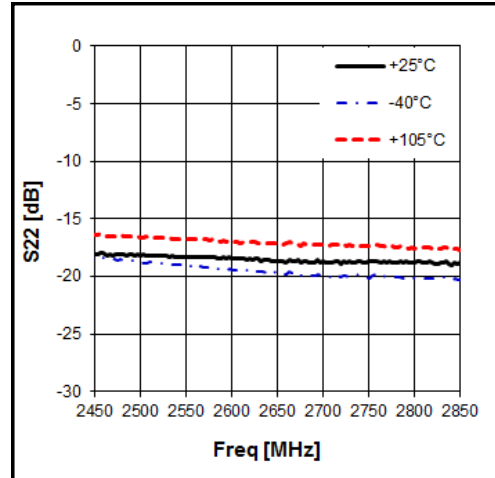
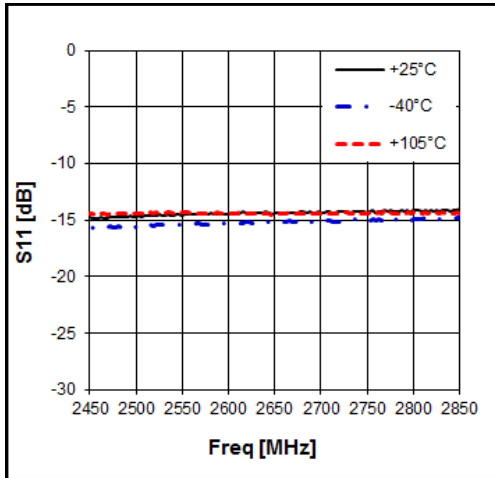

Application Circuit: 3500 MHz

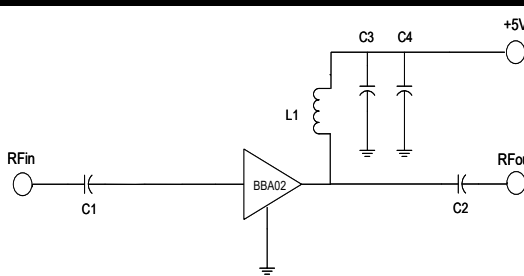
Schematic Diagram	BOM	Tolerance	
	C1	10pF	± 5%
	C2	10pF	± 5%
	C3	100pF	± 5%
	C4	1nF	± 5%
	L1	15nH	± 5%

Typical Performance

(Vd=5V, Id=90mA, T=25°C)

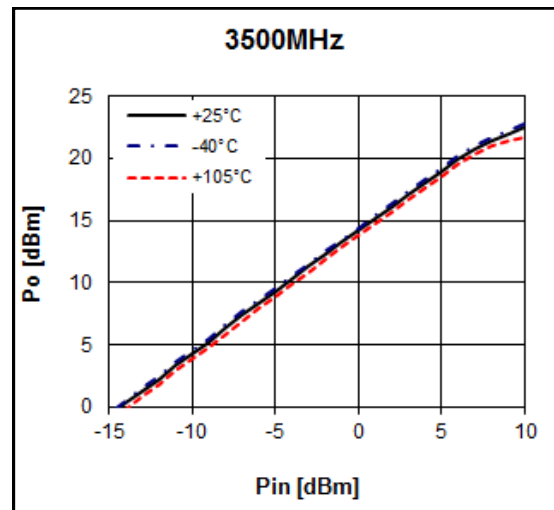
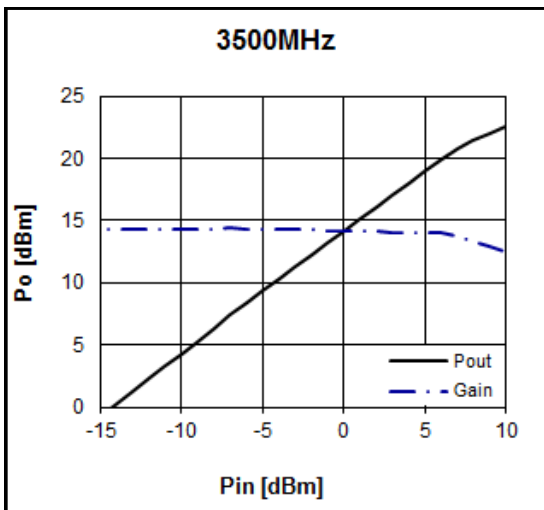

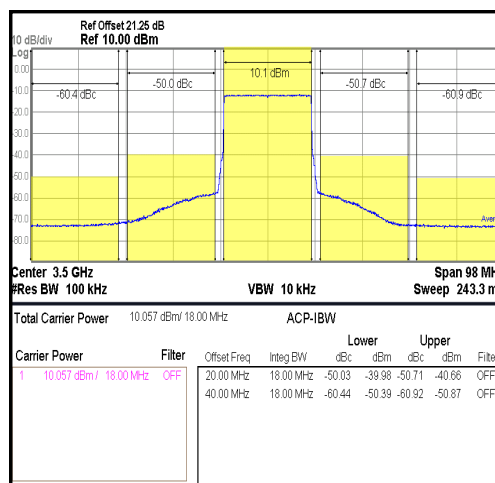
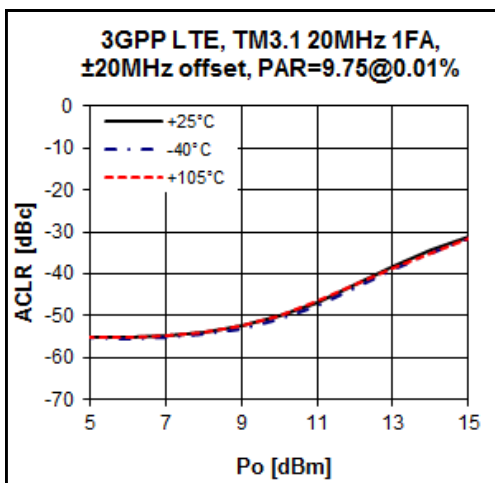
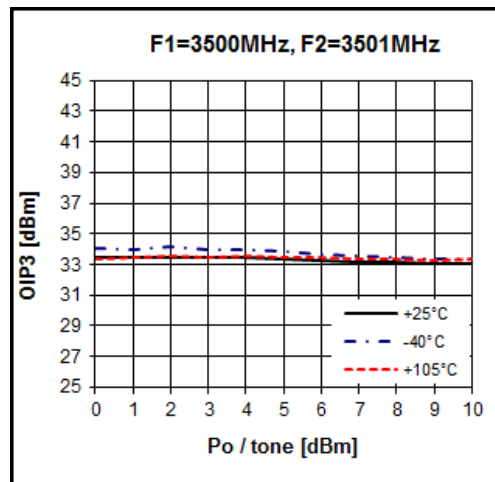
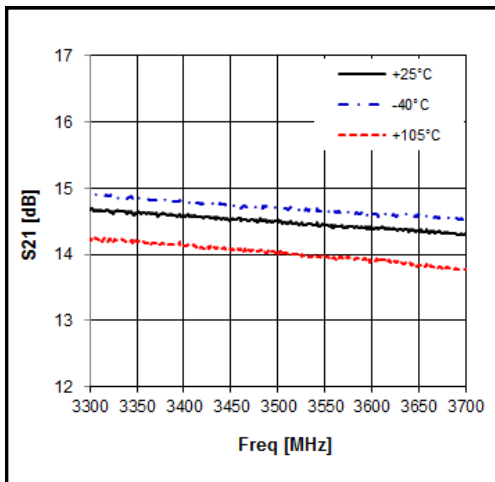
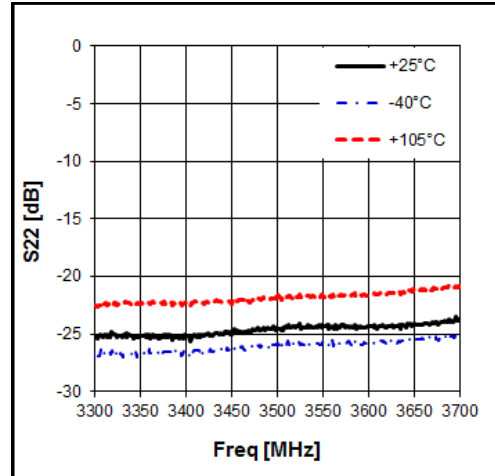
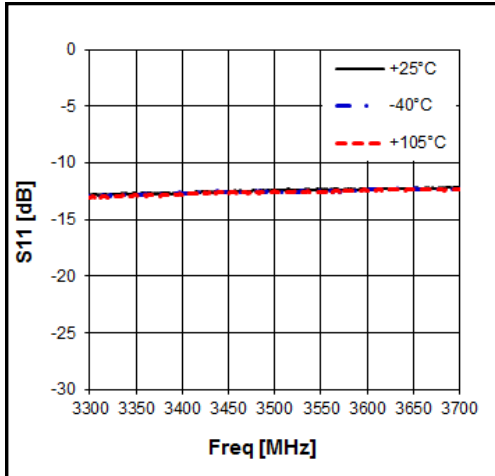

Application Circuit: 4650 MHz

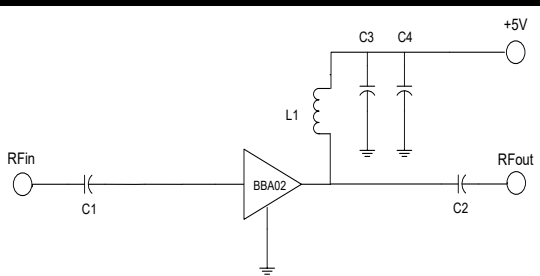
Schematic Diagram	BOM	Tolerance	
	C1	10pF	± 5%
	C2	10pF	± 5%
	C3	100pF	± 5%
	C4	1nF	± 5%
	L1	8.2nH	± 5%

Typical Performance

(Vd=5V, Id=90mA, T=25°C)

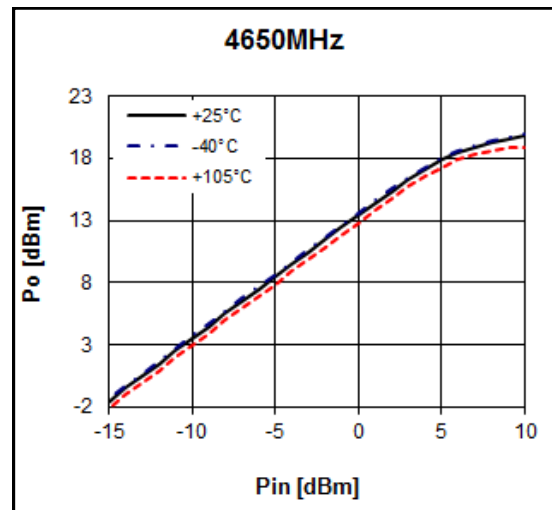
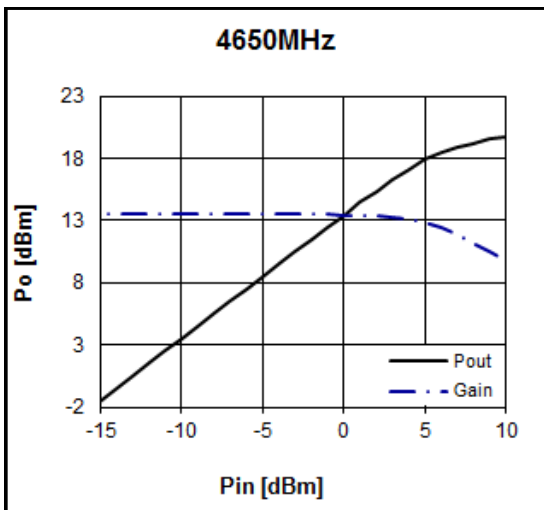

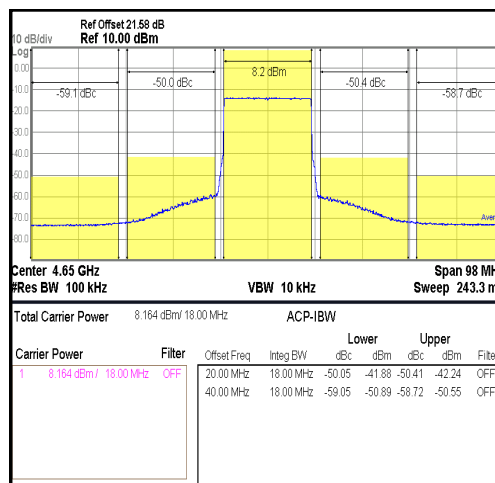
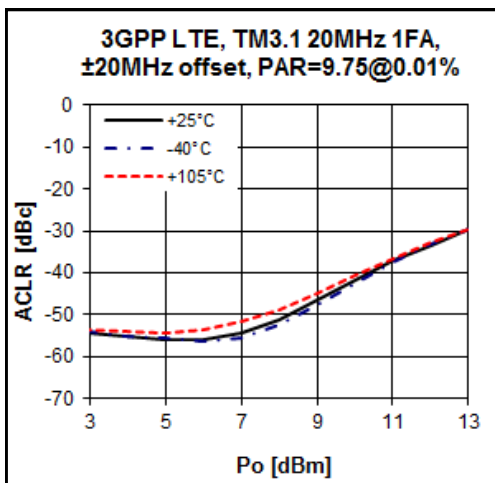
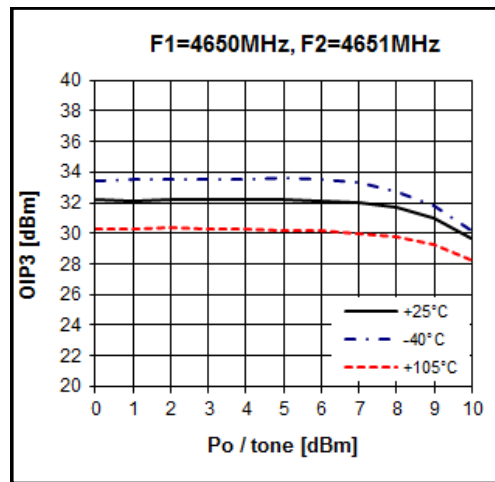
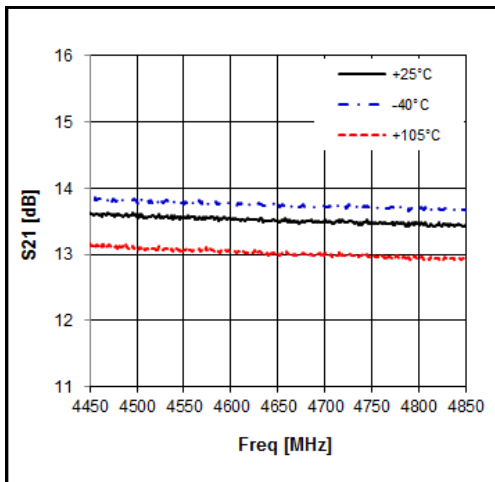
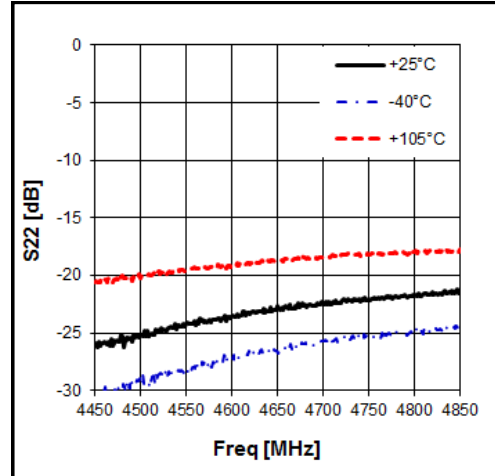
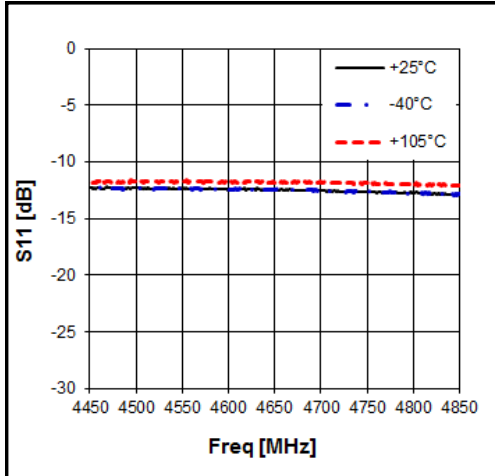

Application Circuit: 5800 MHz

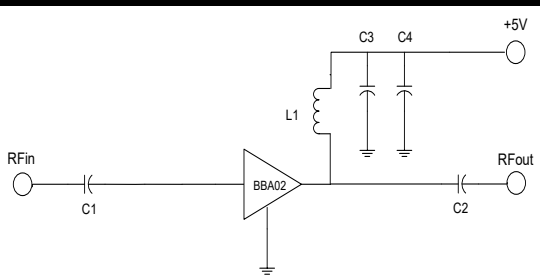
Schematic Diagram	BOM	Tolerance	
	C1	10pF	± 5%
	C2	10pF	± 5%
	C3	100pF	± 5%
	C4	1nF	± 5%
	L1	4.7nH	± 5%

Typical Performance

(Vd=5V, Id=90mA, T=25°C)

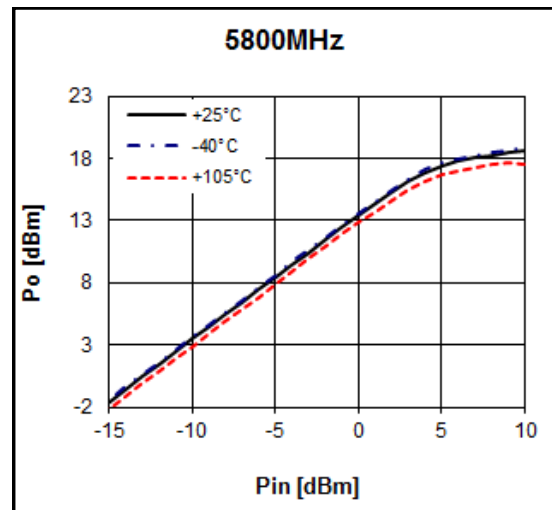
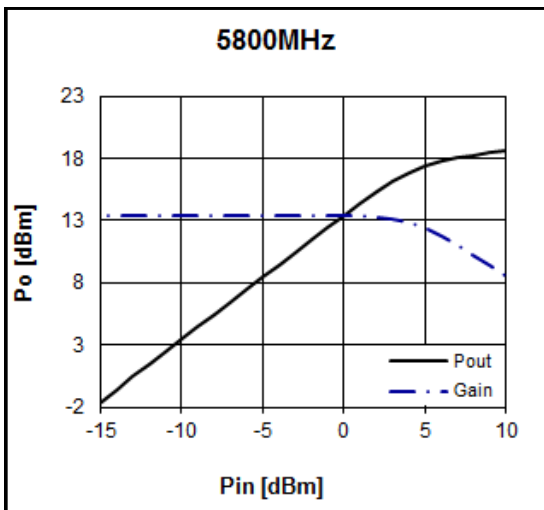

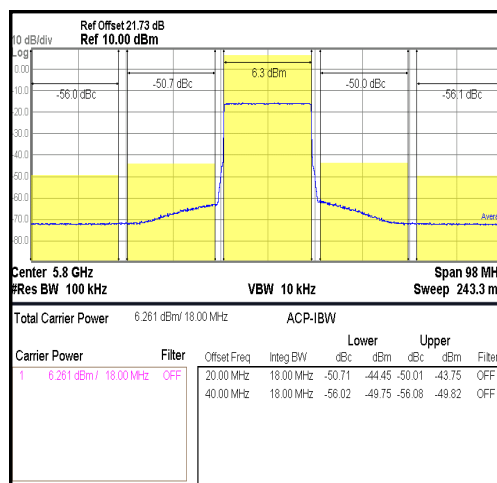
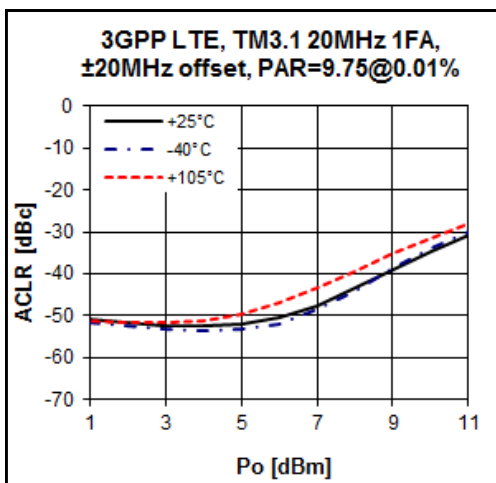
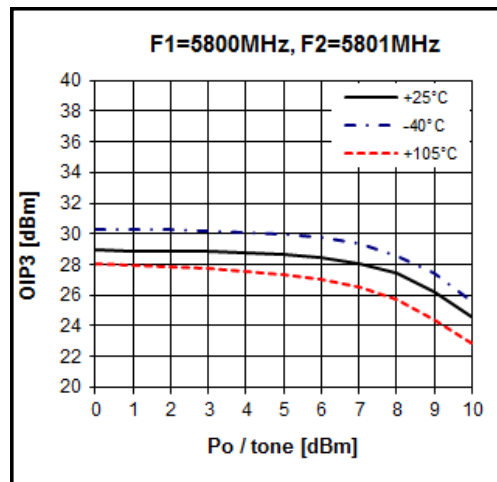
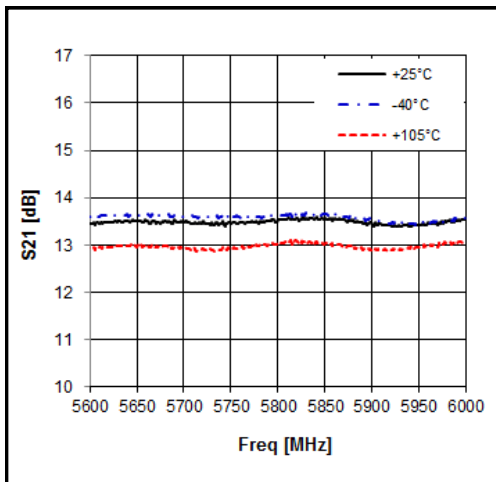
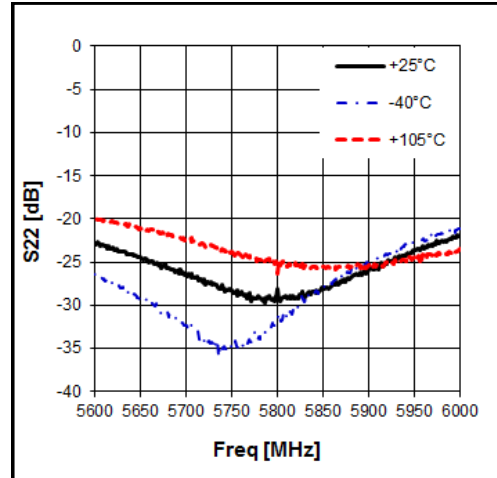
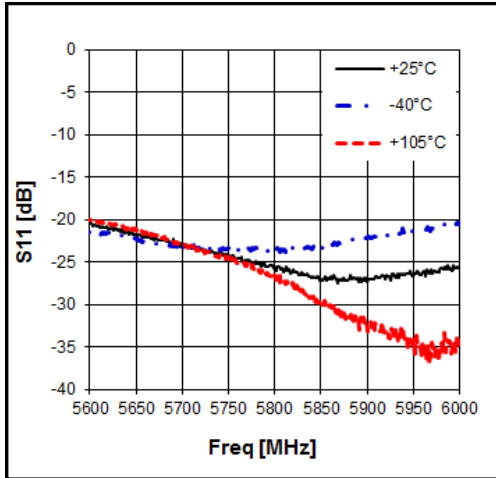

Package Outline Dimension

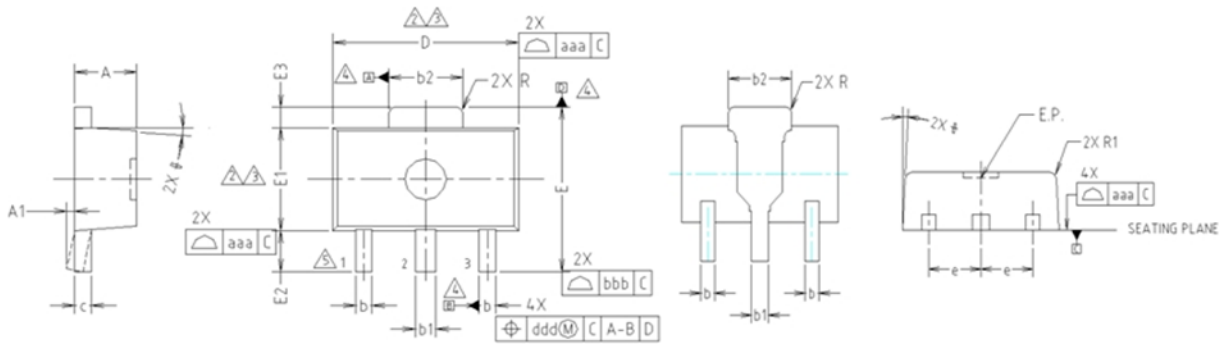

- NOTE:
1. DIMENSIONS IN MILLIMETERS.
- ⚠ DIMENSION D DOES NOT INCLUDE MOLD FLASH, PROTRUSIONS OR GATE BURRS. MOLD FLASH, PROTRUSIONS OR GATE BURRS SHALL NOT EXCEED 0.5mm PER END. DIMENSION E1 DOES NOT INCLUDE INTERLEAD FLASH OR PROTRUSION. INTERLEAD FLASH OR PROTRUSION SHALL NOT EXCEED 0.5mm PER SIDE.
 - ⚠ DIMENSIONS D AND E1 ARE DETERMINED AT THE OUTMOST EXTREMES OF THE PLASTIC BODY EXCLUSIVE OF MOLD FLASH, TIE BAR BURRS, GATE BURRS AND INTERLEAD FLASH, BUT INCLUDING ANY MISMATCH BETWEEN THE TOP AND BOTTOM OF THE PLASTIC BODY.
 - ⚠ DATUMS A, B AND D TO BE DETERMINED 0.18mm FROM THE LEAD TIP.
 - ⚠ TERMINAL NUMBERS ARE SHOWN FOR REFERENCE ONLY.

SYMBOL	MILLIMETERS			NOTE
	MINIMUM	NOMINAL	MAXIMUM	
A	1.40	1.50	1.60	
A1	0.00	—	0.10	
b	0.38	0.42	0.48	
b1	0.48	0.52	0.58	
b2	1.79	1.82	1.87	
c	0.40	0.42	0.46	
D	4.40	4.50	4.70	2,3
E	3.70	4.00	4.30	
E1	2.40	2.50	2.70	2,3
E2	0.80	1.00	1.20	
E3	0.40	0.50	0.60	
e	1.50 TYP.			
φ	4° TYP.			
R	0.15 TYP.			
R1	—	—	0.20	
SYMBOL	TOLERANCES OF FORM AND POSITION		NOTE	
aaa	0.15			
bbb	0.20			
ccc	0.10			
ddd	0.10			

Suggested PCB Land Pattern and PAD Layout

PCB Land Pattern

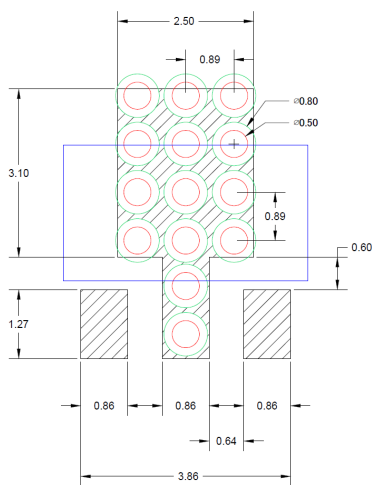

PCB Mounting

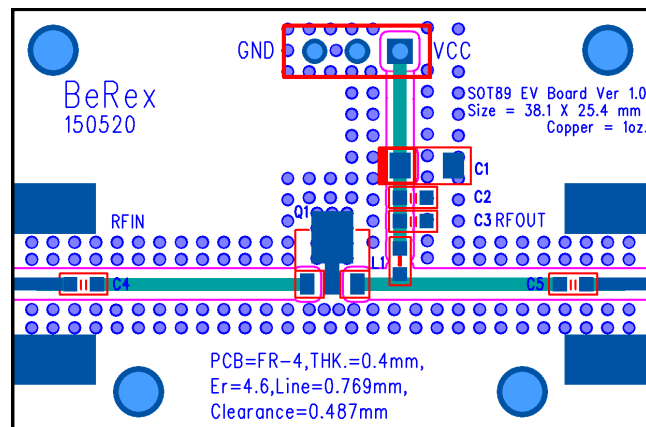

Note : All dimension _ millimeters

PCB lay out _ on BeRex website

Package Marking

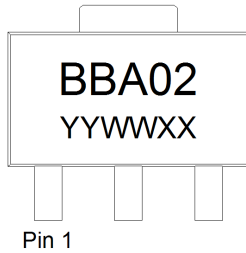

YY = Year, WW = Working Week,
XX = Wafer No.

Tape & Reel

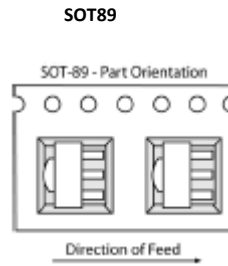

Packaging information:

- Tape Width (mm): 12
- Reel Size (inches): 7
- Device Cavity Pitch (mm): 8
- Devices Per Reel: 1000

Lead plating finish

100% Tin Matte finish

(All BeRex products undergoes a 1 hour, 150 degree C, Anneal bake to eliminate thin whisker growth concerns.)

MSL / ESD Rating

ESD Rating:	Class 0
Value:	Passes <200V
Test:	Human Body Model (HBM)
Standard:	JEDEC Standard JS-001-2014
MSL Rating:	Level 1 at +260°C convection reflow
Standard:	JEDEC Standard J-STD-020



Proper ESD procedures should be followed when handling this device.

RoHS Compliance

This part is compliant with Restrictions on the Use of Certain Hazardous Substances in Electrical and Electronic Equipment (RoHS) Directive 2011/65/EU as amended by Directive 2015/863/EU.



This product also is compliant with a concentration of the Substances of Very High Concern (SVHC) candidate list which are contained in a quantity of less than 0.1%(w/w) in each components of a product and/or its packaging placed on the European Community market by the BeRex and Suppliers.

NATO CAGE code:

2	N	9	6	F
---	---	---	---	---

Looking for pricing, stock, or lifecycle information?

Click below to explore more details on WIN SOURCE:

-  [View BBA02 on WIN SOURCE](#)
-  [BeRex Corporation](#) Information

Optimize Your Supply Chain with WIN SOURCE Solutions

-  Global Sourcing Solution
-  Obsolete Management
-  Cost Control Management
-  Shortage Management
-  Alternative Solution
-  Excess Inventory Management