

Device Features

- Single Fixed 3V supply
- No Dropping Resistor Required
- No matching circuit needed
- Green/RoHS2 compliant SOT-363 package
- Application: Driver Amplifier, Cellular, PCS, GSM, UMTS, WCDMA, Wireless Data

Product Description

BeRex's BGS2 is a high SiGe HBT MMIC amplifier, internally matched to 50 Ohms without the need for external components. Designed to run directly from a 3V supply. The BGS2 is designed for high linearity 3V gain block applications. It is packaged in a RoHS2-compliant with SOT-363 surface mount package.

Applications

- Driver Amplifier
- Cellular, PCS, GSM, UMTS, WCDMA

Applications Circuit

Application Circuit Values Example			
Freq.	70~900MHz	900MHz ~ 3GHz	3GHz ~ 4GHz
C1/C2	2nF	100pF	100pF
L1 (1608 Chip Ind.)	1uH	56nH	27nH

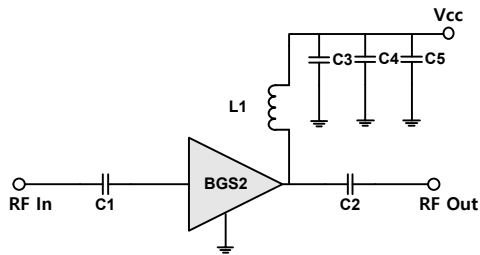

- *C1, C2, C3 =100 pF ± 5%; C4 = 1 nF ± 5%; C5 = 10uF; **L1 = 56nH
- **less than 56nH improves RF performance at over 0.9GHz.
- *1uH or higher value L1 improves RF performance at under 900MHz.
- *Optimum value of L1 may vary with board design.
- *C1,C2=2nF, L1=1uH for 70MHz application,
- *C1,C2=100pF, L1=27nH for 3.5GHz application.

Part Marking (XX:Wafer number)

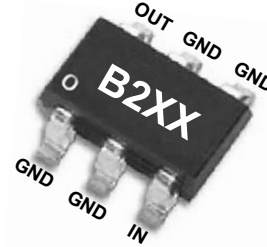

Pin Description	
RF IN	3
RF OUT	6
GND	1,2,4,5

Electrical Specifications

Device performance _ measured on a BeRex evaluation board at 25°C, Vd=3V, 50 Ω system.

Parameter	Conditions	Min	Typ	Max	Unit
Operational Frequency Range		50		4000	MHz
Test Frequency			900		MHz
Gain		22.1	23.6		dB
Input Return Loss			-18.3		dB
Output Return Loss			-12.8		dB
Output IP3	0 dBm / tone , Δf=1 MHz	22.5	25.5		dBm
Output P1dB		12.4	13.4		dBm
Noise Figure			2.3		dB

Recommended Operating Conditions

Parameter	Min	Typ	Max	Unit
Bandwidth	50		4000	MHz
I _c @ (V _c = 3.0V)	28	34	40	mA
V _c	2.85	3.0	3.3	V
dG/dT		-0.005		
R _{TH}		130		°C/W
Operating Case Temperature	-40		+105	°C

Electrical specifications are measured at specified test conditions.

Specifications are not guaranteed over all recommended operating conditions.

Absolute Maximum Ratings

Parameter	Rating	Unit
Storage Temperature	-55 to +155	°C
Junction Temperature	+165	°C
Supply Voltage	+3.9	V
Supply Current	100	mA
Input RF Power	15	dBm

Operation of this device above any of these parameters may result in permanent damage.

50-4000 MHz SILICON GERMANIUM Gain Block

Typical Performance (Vd = 3.0V, Ic = 34mA, T = 25°C)

Freq	MHz	50	70	900	1900	2140	2450	2650	3500
S21	dB	26.8	26.5	23.6	19.8	19	18.1	17.2	15.0
S11	dB	-18.4	-19.6	-18.3	-18.6	-18.4	-18.1	-17.6	-13.7
S22	dB	-16	-15.6	-12.8	-9.9	-9.4	-10.5	-13.2	-15.7
P1	dBm	15.4	15.6	13.4	12.8	11.2	10.8	10.4	8.7
OIP3	dBm	28.5	28	25.5	24.5	23	22.5	25	19.2
NF	dB	2.7	2.7	2.3	2.2	2.2	2.3	2.5	2.7

Typical Performance (Vd = 3.1V, Ic = 41mA, T = 25°C)

Freq	MHz	50	70	900	1900	2140	2450	2650
S21	dB	27.1	26.8	23.7	19.9	19.1	18.2	17.4
S11	dB	-16.7	-17.2	-17.2	-17.9	-17.9	-18.3	-18.0
S22	dB	-15.5	-14.7	-12.5	-9.4	-9.5	-10.6	-13.4
P1	dBm	16.0	16.5	14.0	13.1	12.0	11.2	10.8
OIP3	dBm	29.5	29.0	26.5	25.4	23.5	23.0	25.0
NF	dB	2.7	2.7	2.3	2.2	2.2	2.3	2.5

Typical Performance (Vd = 3.2V, Ic = 47mA, T = 25°C)

Freq	MHz	50	70	900	1900	2140	2450	2650
S21	dB	27.4	27.1	23.9	20.0	19.2	18.3	17.5
S11	dB	-15.2	-15.5	-16.3	-17.2	-17.3	-18.0	-18.3
S22	dB	-14.8	-13.7	-12.1	-9.6	-9.6	-10.7	-13.6
P1	dBm	16.8	17.2	14.6	13.3	12.0	11.2	11.0
OIP3	dBm	30.0	30.0	27.0	26.0	24.0	23.5	25.1
NF	dB	2.7	2.7	2.3	2.2	2.2	2.3	2.5

Typical Performance (Vd = 3.3V, Ic = 53mA, T = 25°C)

Freq	MHz	50	70	900	1900	2140	2450	2650
S21	dB	27.6	27.3	23.9	20.0	19.3	18.4	17.6
S11	dB	-14.1	-14.2	-15.5	-16.7	-16.8	-17.8	-18.4
S22	dB	-14.2	-12.9	-11.8	-9.7	-9.7	-10.0	-13.9
P1	dBm	17.4	18.0	15.0	13.6	12.3	11.7	11.3
OIP3	dBm	32.0	30.0	27.0	26.2	24.5	23.1	26.0
NF	dB	2.7	2.7	2.3	2.2	2.2	2.3	2.5

V-I Characteristics

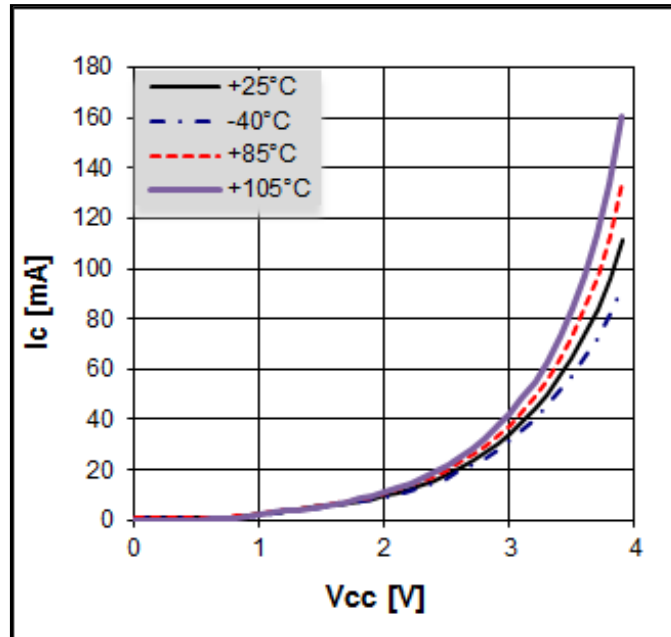

BeRex SOT-363 Evaluation Board

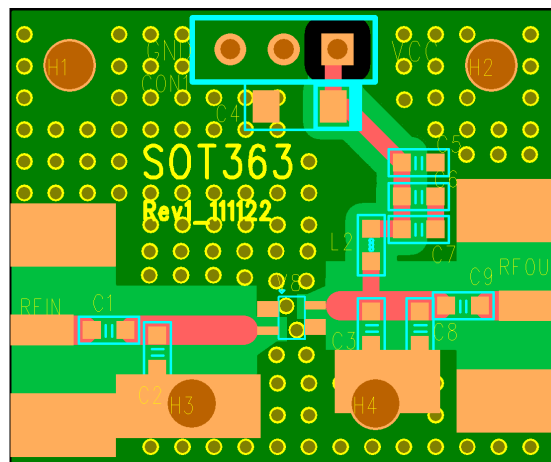

*Dielectric constant _ 4.2 *31mil thick FR4 PCB

Typical Device Data

S-parameters (Vc=3V, Ic=34mA, T=25°C)

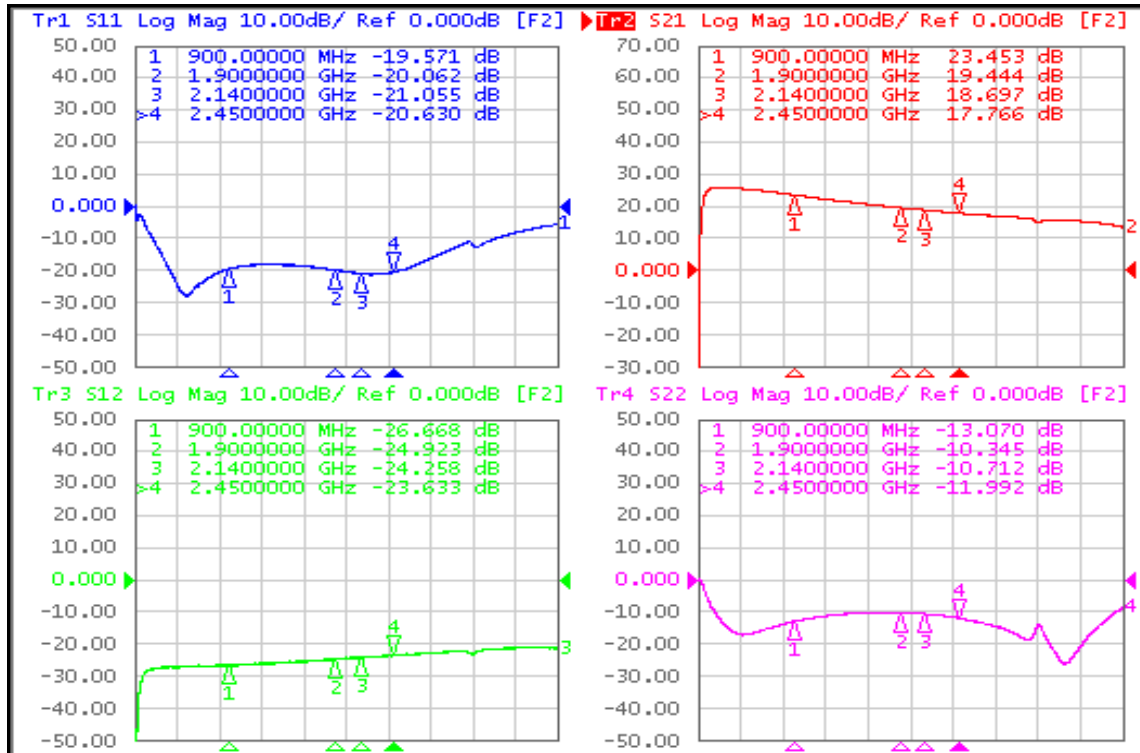

S-Parameter

(Vdevice = 3.0V, Icc = 34mA, T = 25 °C, calibrated to device leads)

Freq [MHz]	S11 Mag	S11 Ang	S21 Mag	S21 Ang	S12 Mag	S12 Ang	S22 Mag	S22 Ang
70	-3.69	-52.41	24.13	-121.02	-30.59	82.59	-4.42	-170.10
900	-17.69	34.25	23.38	76.30	-26.60	-28.23	-12.45	142.20
1000	-17.25	22.43	22.95	65.43	-26.52	-34.19	-12.00	136.29
1500	-17.21	-18.66	20.82	16.20	-25.69	-57.19	-10.22	103.27
2000	-19.07	-63.14	19.00	-28.30	-24.73	-82.74	-10.16	73.85
2500	-20.38	-132.94	17.52	-71.11	-23.50	-111.35	-11.80	48.64
3500	-10.04	90.91	15.48	-158.27	-21.28	-175.51	-26.52	64.38
4000	-6.03	26.54	13.56	143.48	-20.97	137.09	-9.21	111.96

Typical Performance
 (Vd = 3.0V, Ic = 34mA, T = 25°C)

Pin-Pout-Gain

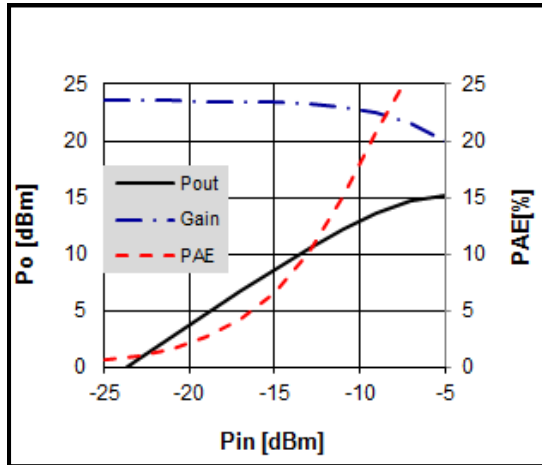

900MHz

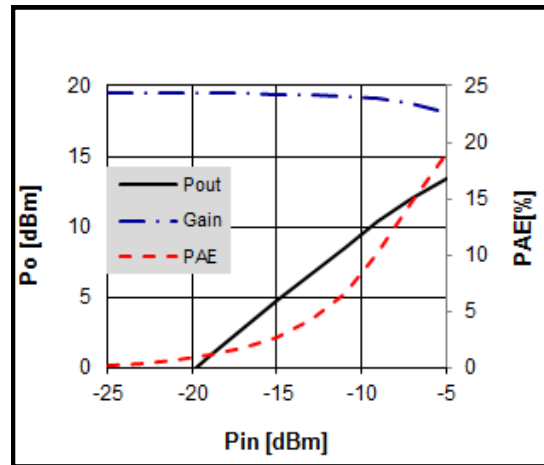

1900 MHz

OIP3

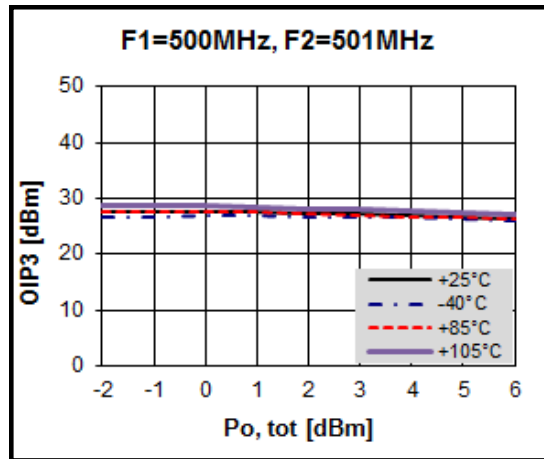
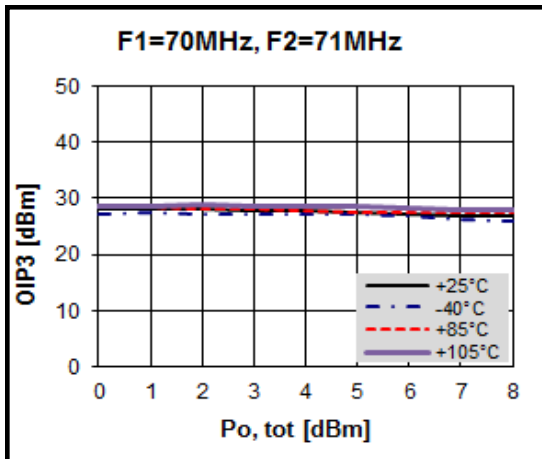

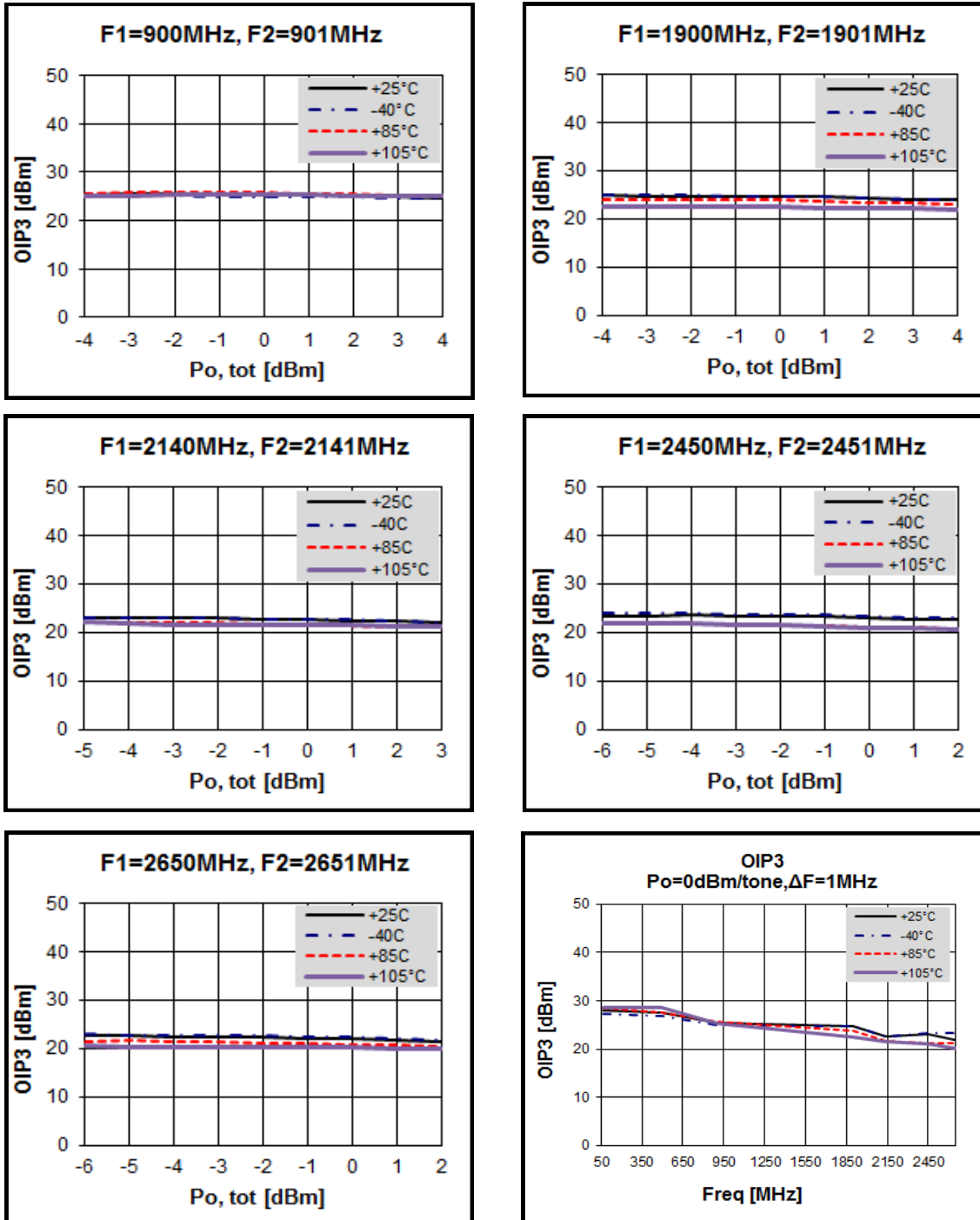
OIP3

Gain Flatness

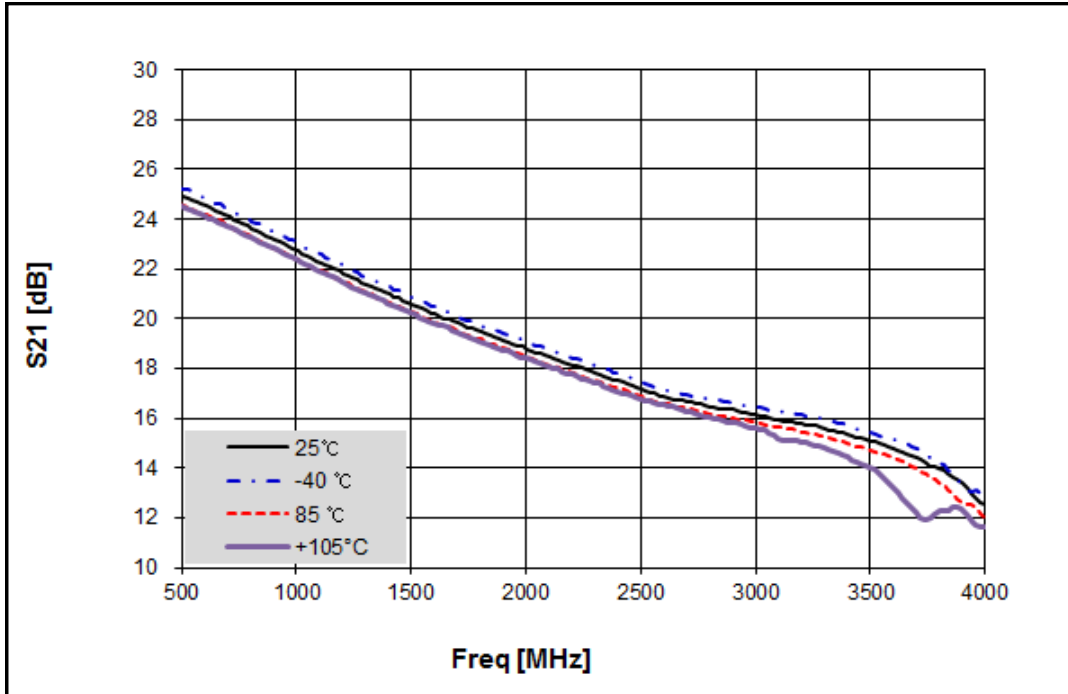

SOT-363 Package Outline Dimension (Unit. mm)

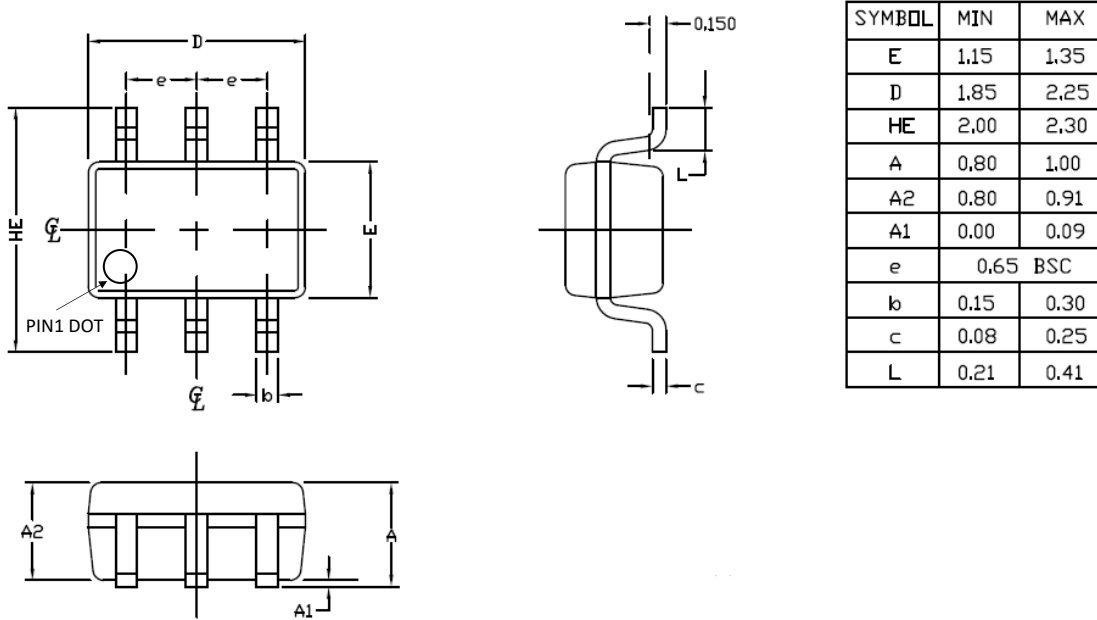

Suggested PCB Land Pattern and PAD Layout

PCB Land Pattern

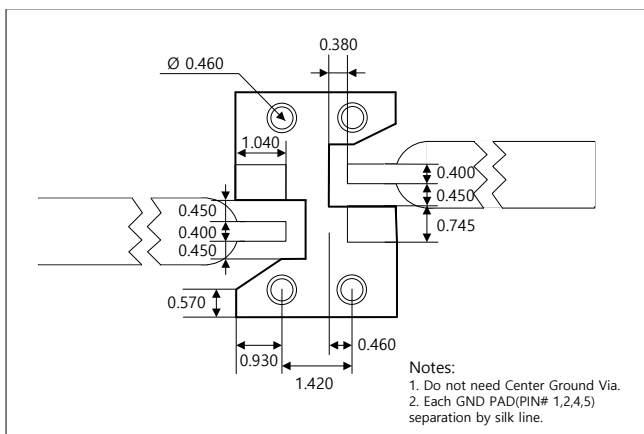

PCB Mounting

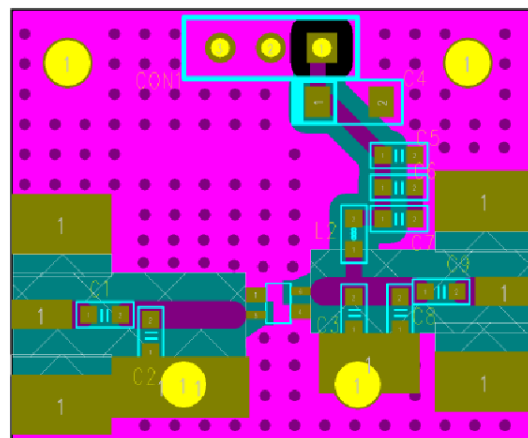

Package Marking

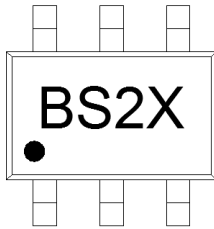

X = Wafer No.

Pin 1

New Package Marking

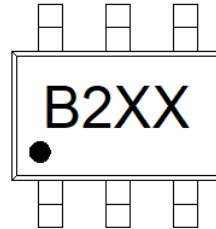

XX = Wafer No.

Pin 1

* Note : New Package marking has been modified from BS2X to B2XX since Aug. 2017.

Tape & Reel

SOT-363

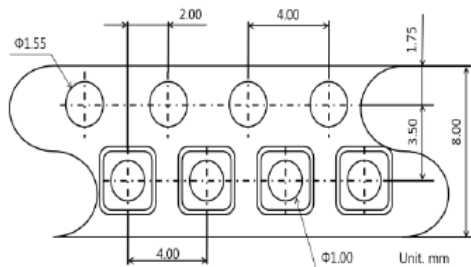

Packaging information:

- Tape Width (mm): 8
- Reel Size (inches): 7
- Device Cavity Pitch (mm): 4
- Devices Per Reel: 3000

Lead plating finish

100% Tin Matte finish

(All BeRex products undergoes a 1 hour, 150 degree C, Anneal bake to eliminate thin whisker growth concerns.)

MSL / ESD Rating

ESD Rating:	Class 1C
Value:	Passes <2000V
Test:	Human Body Model (HBM)
Standard:	JEDEC Standard JESD22-A114
MSL Rating:	Level 1 at +260°C convection reflow
Standard:	JEDEC Standard J-STD-020



Proper ESD procedures should be followed when handling this device.

RoHS Compliance

This part is compliant with Restrictions on the Use of Certain Hazardous Substances in Electrical and Electronic Equipment (RoHS) Directive 2011/65/EU as amended by Directive 2015/863/EU.



This product also is compliant with a concentration of the Substances of Very High Concern (SVHC) candidate list which are contained in a quantity of less than 0.1%(w/w) in each components of a product and/or its packaging placed on the European Community market by the BeRex and Suppliers.

NATO CAGE code:

2	N	9	6	F
---	---	---	---	---

Looking for pricing, stock, or lifecycle information?

Click below to explore more details on WIN SOURCE:

-  [View BGS2 on WIN SOURCE](#)
-  [BeRex Corporation](#) Information

Optimize Your Supply Chain with WIN SOURCE Solutions

-  Global Sourcing Solution
-  Obsolete Management
-  Cost Control Management
-  Shortage Management
-  Alternative Solution
-  Excess Inventory Management