

# BGM15MA12

Mid-Band LNA Multiplexer Module

## Data Sheet

Revision 3.0 - 2015-07-24

**Edition 2015-07-24**

**Published by Infineon Technologies AG  
81726 Munich, Germany**

**©2015 Infineon Technologies AG  
All Rights Reserved.**

## **LEGAL DISCLAIMER**

The information given in this document shall in no event be regarded as a guarantee of conditions or characteristics. With respect to any examples or hints given herein, any typical values stated herein and/or any information regarding the application of the device, Infineon Technologies hereby disclaims any and all warranties and liabilities of any kind, including without limitation, warranties of non-infringement of intellectual property rights of any third party.

## **Information**

For further information on technology, delivery terms and conditions and prices, please contact the nearest Infineon Technologies Office ([www.infineon.com](http://www.infineon.com)).

## **Warnings**

Due to technical requirements, components may contain dangerous substances. For information on the types in question, please contact the nearest Infineon Technologies Office. Infineon Technologies components may be used in life-support devices or systems only with the express written approval of Infineon Technologies, if a failure of such components can reasonably be expected to cause the failure of that life-support device or system or to affect the safety or effectiveness of that device or system. Life support devices or systems are intended to be implanted in the human body or to support and/or maintain and sustain and/or protect human life. If they fail, it is reasonable to assume that the health of the user or other persons may be endangered.

## Revision History

**Document No.:** BGM15MA12\_\_v3.0.pdf

**Revision History:** Rev. v3.0

**Previous Version:** Preliminary, Revision v2.4 - 2014-08-21

Page	Subjects (major changes since last revision)
all	"Preliminary" status removed
8	Typo at 3 <sup>rd</sup> -order intercept point values for Band 1 corrected
19	Package Outline Drawing: Minimum package height specified
19	Marking Specification added
20	Footprint Recommendation added

### Trademarks of Infineon Technologies AG

AURIX™, C166™, CanPAK™, CIPOS™, CIPURSE™, CoolGaN™, CoolMOS™, CoolSET™, CoolSiC™, CORECONTROL™, CROSSAVE™, DAVE™, DI-POL™, DrBLADE™, EasyPIM™, EconoBRIDGE™, EconoDUAL™, EconoPACK™, EconoPIM™, EiceDRIVER™, eupec™, FCOS™, HITFET™, HybridPACK™, ISOFACE™, IsoPACK™, i-Wafer™, MIPAQ™, ModSTACK™, my-d™, NovalithiC™, OmniTune™, OPTIGA™, OptiMOS™, ORIGA™, POWERCODE™, PRIMARION™, PrimePACK™, PrimeSTACK™, PROFET™, PRO-SIL™, RASIC™, REAL3™, ReverSave™, SatRIC™, SIEGET™, SIPMOS™, SmartLEWIS™, SOLID FLASH™, SPOC™, TEMPFET™, thinQ!™, TRENCHSTOP™, TriCore™.

### Other Trademarks

Advance Design System™ (ADS) of Agilent Technologies, AMBA™, ARM™, MULTI-ICE™, KEIL™, PRIMECELL™, REALVIEW™, THUMB™,  $\mu$ Vision™ of ARM Limited, UK. ANSI™ of American National Standards Institute. AUTOSAR™ of AUTOSAR development partnership. Bluetooth™ of Bluetooth SIG Inc. CAT-iq™ of DECT Forum. COLOSSUS™, FirstGPS™ of Trimble Navigation Ltd. EMV™ of EMVCo, LLC (Visa Holdings Inc.). EPCOS™ of Epcos AG. FLEXGO™ of Microsoft Corporation. HYPERTERMINAL™ of Hilgraeve Incorporated. MCS™ of Intel Corp. IEC™ of Commission Electrotechnique Internationale. IrDA™ of Infrared Data Association Corporation. ISO™ of INTERNATIONAL ORGANIZATION FOR STANDARDIZATION. MATLAB™ of MathWorks, Inc. MAXIM™ of Maxim Integrated Products, Inc. MICROTEC™, NUCLEUS™ of Mentor Graphics Corporation. MIPI™ of MIPI Alliance, Inc. MIPS™ of MIPS Technologies, Inc., USA. muRata™ of MURATA MANUFACTURING CO., MICROWAVE OFFICE™ (MWO) of Applied Wave Research Inc., OmniVision™ of OmniVision Technologies, Inc. Openwave™ of Openwave Systems Inc. RED HAT™ of Red Hat, Inc. RFMD™ of RF Micro Devices, Inc. SIRIUS™ of Sirius Satellite Radio Inc. SOLARIS™ of Sun Microsystems, Inc. SPANSION™ of Spansion LLC Ltd. Symbian™ of Symbian Software Limited. TAIYO YUDEN™ of Taiyo Yuden Co. TEAKLITE™ of CEVA, Inc. TEKTRONIX™ of Tektronix Inc. TOKO™ of TOKO KABUSHIKI KAISHA TA. UNIX™ of X/Open Company Limited. VERILOG™, PALLADIUM™ of Cadence Design Systems, Inc. VLYNQ™ of Texas Instruments Incorporated. VXWORKS™, WIND RIVER™ of WIND RIVER SYSTEMS, INC. ZETEX™ of Diodes Zetex.

Last Trademarks Update 2014-07-17

## Contents

<b>1</b>	<b>Features</b>	<b>5</b>
<b>2</b>	<b>Product Description</b>	<b>5</b>
<b>3</b>	<b>Maximum Ratings</b>	<b>6</b>
<b>4</b>	<b>DC Characteristics</b>	<b>7</b>
<b>5</b>	<b>RF Characteristics</b>	<b>8</b>
5.1	BAND 1 . . . . .	8
5.2	BAND 2 . . . . .	9
5.3	BAND 3 . . . . .	10
<b>6</b>	<b>MIPI RFFE Specification</b>	<b>11</b>
<b>7</b>	<b>Application Information</b>	<b>17</b>
<b>8</b>	<b>Package Information</b>	<b>19</b>

## List of Figures

1	BGM15MA12 Block diagram . . . . .	6
2	Received clock signal constraints . . . . .	12
3	Bus active data receiver timing requirements . . . . .	13
4	Bus park cycle timing . . . . .	13
5	Bus active data transmission timing specification . . . . .	14
6	Requirements for VIO-initiated reset . . . . .	14
7	BGM15MA12 Pin Configuration (top view) . . . . .	17
8	BGM15MA12 Application Schematic . . . . .	18
9	ATSLP-12-2 Package Outline (top, side and bottom views) . . . . .	19
10	Marking Specification (top view) . . . . .	19
11	Footprint Recommendation . . . . .	20
12	ATSLP-12-2 Carrier Tape . . . . .	20

## List of Tables

1	Ordering Information . . . . .	5
2	Maximum Ratings . . . . .	6
4	DC Characteristics . . . . .	7
5	RF Characteristics Band 1 . . . . .	8
6	RF Characteristics Band 2 . . . . .	9
7	RF Characteristics Band 3 . . . . .	10
8	MIPI Features . . . . .	11
9	Startup Behavior . . . . .	11
10	MIPI RFFE operating timing . . . . .	12
11	Register Mapping . . . . .	14
12	Truth Table, Register_0 . . . . .	16
13	Pin Definition and Function . . . . .	17
14	Bill of Materials . . . . .	18

## BGM15MA12 Mid-Band LNA Multiplexer Module

### 1 Features

- Power gain: 16.7 dB
- Low noise figure: 1.15 dB
- Low current consumption: 4.9 mA
- Frequency range from 1.7 to 2.2 GHz
- RF output internally matched to 50  $\Omega$
- Low external component count
- High port-to-port-isolation
- Suitable for LTE / LTE-Advanced and 3G applications
- No decoupling capacitors required if no DC applied on RF lines
- On chip control logic including ESD protection
- Supply voltage: 2.2 to 3.3 V
- Integrated MIPI RFFE interface operating in 1.1 to 1.95 V voltage range
- Software programmable MIPI RFFE USID
- Small form factor 1.1 mm x 1.9 mm
- High EMI robustness
- RoHS and WEEE compliant package

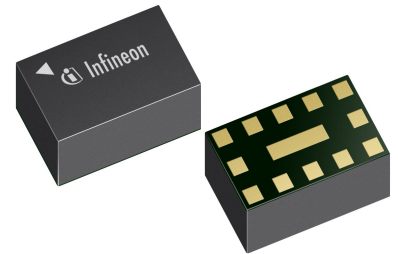

### 2 Product Description

The BGM15MA12 is a LNA multiplexer module for LTE mid-band frequencies that increases the data rate while keeping flexibility and low footprint. It is a perfect solution for multimode handsets based on LTE-Advanced and WCDMA. The device configuration is shown in Fig. 12.

**Table 1: Ordering Information**

Type	Package	Marking
BGM15MA12	ATSLP-12-2	M2

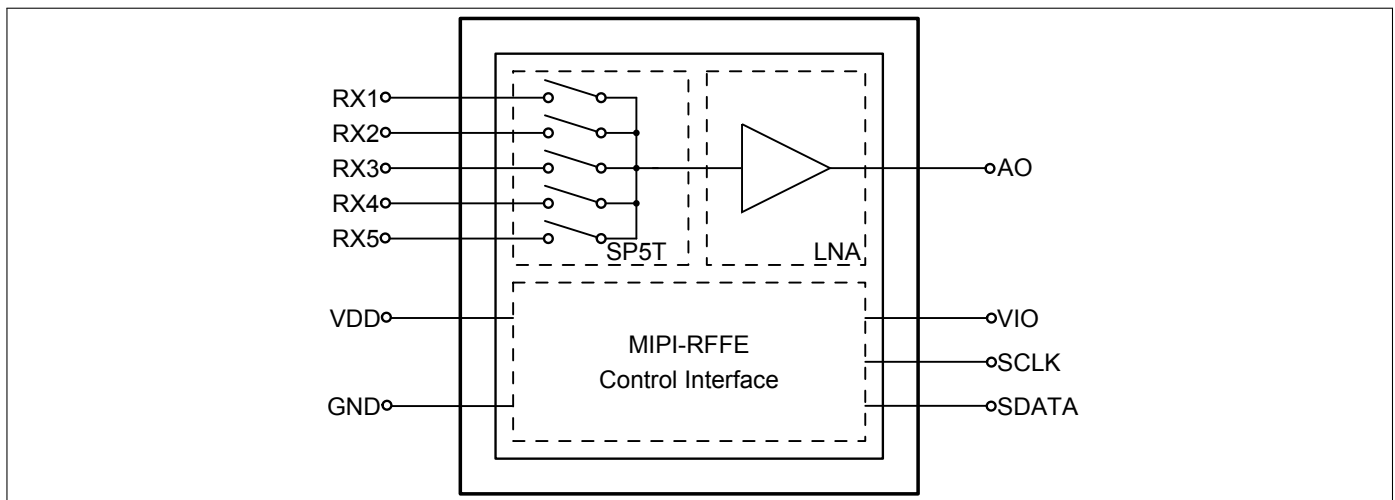
**Figure 1:** BGM15MA12 Block diagram

### 3 Maximum Ratings

**Table 2: Maximum Ratings**

Parameter	Symbol	Values			Unit	Note / Test Condition
		Min.	Typ.	Max.		
Supply Voltage VDD	$V_{DD}$	2.2	–	3.6	V	1
Voltage at RF pins Rx	$V_{Rx}$	-0.3	–	0.9	V	–
Voltage at RF output pin AO	$V_{AO}$	-0.3	–	$V_{DD}+0.3$	V	–
Voltage at GND pins	$V_{GND}$	-0.3	–	0.3	V	–
Current into pin VDD	$I_{DD}$	–	–	16	mA	–
RF input power	$P_{IN}$	–	–	0	dBm	–
Total power dissipation	$P_{tot}$	–	–	60	mW	–
Junction temperature	$T_J$	–	–	150	°C	–
Ambient temperature range	$T_A$	-40	–	85	°C	–
Storage temperature range	$T_{STG}$	-65	–	150	°C	–
ESD capability, HBM	$V_{ESD\_HBM}$	–	–	1000	V	according to JESD22A-114
RFFE Supply Voltage	$V_{IO}$	-0.5	–	3.6	V	–
RFFE Supply Voltage Levels	$V_{SCLK},$ $V_{SDATA}$	-0.7	–	$V_{IO}+0.7$ (max. 3.6)	V	–

<sup>1</sup> All voltages refer to GND-Nodes unless otherwise noted

**Attention: Stresses above the max. values listed here may cause permanent damage to the device. Exposure to absolute maximum rating conditions for extended periods may affect device reliability. Maximum ratings are absolute ratings; exceeding only one of these values may cause irreversible damage to the integrated circuit.**

## 4 DC Characteristics

**Table 4: DC Characteristics at  $T_A = 25\text{ °C}$** 

Parameter <sup>1</sup>	Symbol	Values			Unit	Note / Test Condition
		Min.	Typ.	Max.		
Supply Voltage	$V_{DD}$	2.2	–	3.3	V	–
Supply Current	$I_{DD}$	–	4.9	5.9	mA	ON-mode
		–	0.1	2	$\mu$ A	OFF-Mode
RFFE supply voltage	$V_{IO}$	1.1	1.8	1.95	V	–
RFFE input high voltage <sup>2</sup>	$V_{IH}$	$0.7 \cdot V_{IO}$	–	$V_{IO}$	V	–
RFFE input low voltage <sup>2</sup>	$V_{IL}$	0	–	$0.3 \cdot V_{IO}$	V	–
RFFE output high voltage <sup>2</sup>	$V_{OH}$	$0.8 \cdot V_{IO}$	–	$V_{IO}$	V	–
RFFE output low voltage <sup>2</sup>	$V_{OL}$	0	–	$0.2 \cdot V_{IO}$	V	–
RFFE control input capacitance	$C_{Ctrl}$	–	–	2	pF	–
RFFE supply current	$I_{VIO}$	–	15	–	$\mu$ A	Idle State

<sup>1</sup>Based on the application described in Chapter 7

<sup>2</sup>SCLK and SDATA

## 5 RF Characteristics

### 5.1 BAND 1

**Table 5: RF Characteristics Band 1 at  $T_A = 25\text{ }^\circ\text{C}$ ,  $V_{DD} = 2.8\text{ V}$ ,  $f = 2110 - 2170\text{ MHz}$ , with matching described in Chapter 7 ( $C=1.6\text{ pF}$ ,  $L=3.6\text{ nH}$ )**

Parameter <sup>1</sup>	Symbol	Values			Unit	Note / Test Condition
		Min.	Typ.	Max.		
Insertion power gain <sup>2</sup>	$ S_{21} ^2$	14	15.5	17	dB	–
Noise figure <sup>2</sup>	$NF$	–	1.3	1.8	dB	$Z_S=50\ \Omega$
Input return loss <sup>2 3</sup>	$RL_{in}$	11	15	–	dB	–
Output return loss <sup>2 3</sup>	$RL_{out}$	12	17	–	dB	–
Reverse isolation AO to RX port <sup>2 3</sup>	$1/ S_{12} ^2$	17	22	–	dB	–
Inband input 1dB-compression point <sup>2 3</sup>	$IP_{1dB}$	-11	-8	–	dBm	–
Inband input 3 <sup>rd</sup> -order intercept point <sup>2 3 4</sup>	$IIP_3$	-6	-3	–	dBm	$f_1=2135\text{ MHz}$ , $f_2=2145\text{ MHz}$ , $f_{12}=2125\text{ MHz}$
Isolation RX to RX port <sup>2 5</sup>	ISO	17	29	–	dB	
Isolation RX to AO port <sup>2 5</sup>	ISO	8	17	–	dB	forward direction
Stability <sup>5</sup>	$k$	>1	–	–		$f=20\text{ MHz}-10\text{ GHz}$
RF Rise Time RX Port On/Off <sup>5</sup>	$t_{on/off}$	0.5	1	5	$\mu\text{s}$	10% to 90% ON; 90% to 10% ON
Power Up Settling Time <sup>5</sup>	$t_{BC}$	–	10	25	$\mu\text{s}$	After power down mode

<sup>1</sup>The parameter values are valid at any RX port using the matching described in Chapter 7

<sup>2</sup>PCB losses are subtracted

<sup>3</sup>Verification based on AQL; not 100% tested in production

<sup>4</sup>Input power = -30 dBm for each tone

<sup>5</sup>Guaranteed by device design; not tested in production

## 5.2 BAND 2

**Table 6: RF Characteristics Band 2 at  $T_A = 25\text{ °C}$ ,  $V_{DD} = 2.8\text{ V}$ ,  $f = 1930 - 1990\text{ MHz}$ , with matching described in Chapter 7 ( $C=1.5\text{ pF}$ ,  $L=4.3\text{ nH}$ )**

Parameter <sup>1</sup>	Symbol	Values			Unit	Note / Test Condition
		Min.	Typ.	Max.		
Insertion power gain <sup>2</sup>	$ S_{21} ^2$	14.2	15.7	17.2	dB	–
Noise figure <sup>2</sup>	$NF$	–	1.2	1.7	dB	$Z_S=50\ \Omega$
Input return loss <sup>2 3</sup>	$RL_{in}$	7	10	–	dB	–
Output return loss <sup>2 3</sup>	$RL_{out}$	12	>20	–	dB	–
Reverse isolation AO to RX port <sup>2 3</sup>	$1/ S_{12} ^2$	17	23	–	dB	–
Inband input 1dB-compression point <sup>2 3</sup>	$IP_{1dB}$	-12	-9	–	dBm	–
Inband input 3 <sup>rd</sup> -order intercept point <sup>2 4</sup>	$IIP_3$	-7	-4	–	dBm	$f_1=1955\text{ MHz}$ , $f_2=1965\text{ MHz}$ , $f_{12}=1945\text{ MHz}$
Isolation RX to RX port <sup>2 5</sup>	ISO	17	29	–	dB	
Isolation RX to AO port <sup>2 5</sup>	ISO	8	17	–	dB	forward direction
Stability <sup>5</sup>	$k$	>1	–	–		$f=20\text{ MHz}-10\text{ GHz}$
RF Rise Time RX Port On/Off <sup>5</sup>	$t_{on/off}$	0.5	1	5	$\mu\text{s}$	10% to 90% ON; 90% to 10% ON
Power Up Settling Time <sup>5</sup>	$t_{BC}$	–	10	25	$\mu\text{s}$	After power down mode

<sup>1</sup>The parameter values are valid at any RX port using the matching described in Chapter 7

<sup>2</sup>PCB losses are subtracted

<sup>3</sup>Verification based on AQL; not 100% tested in production

<sup>4</sup>Input power = -30 dBm for each tone

<sup>5</sup>Guaranteed by device design; not tested in production

### 5.3 BAND 3

**Table 7: RF Characteristics Band 3 at  $T_A = 25\text{ °C}$ ,  $V_{DD} = 2.8\text{ V}$ ,  $f = 1805 - 1880\text{ MHz}$ , with matching described in Chapter 7 ( $C=1.6\text{ pF}$ ,  $L=5.1\text{ nH}$ )**

Parameter <sup>1</sup>	Symbol	Values			Unit	Note / Test Condition
		Min.	Typ.	Max.		
Insertion power gain <sup>2</sup>	$ S_{21} ^2$	14.2	15.7	17.2	dB	–
Noise figure <sup>2</sup>	$NF$	–	1.15	1.65	dB	$Z_S=50\ \Omega$
Input return loss <sup>2 3</sup>	$RL_{in}$	7	10	–	dB	–
Output return loss <sup>2 3</sup>	$RL_{out}$	12	16	–	dB	–
Reverse isolation AO to RX port <sup>2 3</sup>	$1/ S_{12} ^2$	17	23	–	dB	–
Inband input 1dB-compression point <sup>2 3</sup>	$IP_{1dB}$	-13	-10	–	dBm	–
Inband input 3 <sup>rd</sup> -order intercept point <sup>2 3 4</sup>	$IIP_3$	-8	-5	–	dBm	$f_1=1837\text{ MHz}$ , $f_2=1847\text{ MHz}$ , $f_{12}=1827\text{ MHz}$
Isolation RX to RX port <sup>2 5</sup>	ISO	17	29	–	dB	
Isolation RX to AO port <sup>2 5</sup>	ISO	8	17	–	dB	forward direction
Stability <sup>5</sup>	$k$	>1	–	–		$f=20\text{ MHz}-10\text{ GHz}$
RF Rise Time RX Port On/Off <sup>5</sup>	$t_{on/off}$	0.5	1	5	$\mu\text{s}$	10% to 90% ON; 90% to 10% ON
Power Up Settling Time <sup>5</sup>	$t_{BC}$	–	10	25	$\mu\text{s}$	After power down mode

<sup>1</sup>The parameter values are valid at any RX port using the matching described in Chapter 7

<sup>2</sup>PCB losses are subtracted

<sup>3</sup>Verification based on AQL; not 100% tested in production

<sup>4</sup>Input power = -30 dBm for each tone

<sup>5</sup>Guaranteed by device design; not tested in production

## 6 MIPI RFFE Specification

All sequences are implemented according to the 'MIPI Alliance Specification for RF Front-End Control Interface' document version 1.10 - 26. July 2011.

**Table 8: MIPI Features**

Feature	Supported	Comment
Register write command sequence	Yes	
Register read command sequence	Yes	
Extended register write command sequence	No	Up to 4 Bytes
Extended register read command sequence	No	Up to 4 Bytes
Register 0 write command sequence	Yes	
Trigger function	Yes	Trigger assignment to each control register is supported
Programmable USID	Yes	3 register command sequence and extended register command sequence
Status Register	Yes	Register for debugging
Reset	Yes	By VIO, Power Mode and RFFE_STATUS
Group SID	Yes	
USID_Sel pin	No	External pin for changing USID is not implemented
Full speed write	Yes	
Half speed read	Yes	
Full speed read	Yes	

**Table 9: Startup Behavior**

Feature	State	Comment
Power status	LOW POWER	The chip is in low power mode after startup
Trigger function	ENABLED	Trigger function is enabled after startup. Trigger function can be disabled via PM_TRIG register.

**Table 10: MIPI RFFE Operating Timing**

Parameter	Symbol	Values			Unit	Note / Test Condition
		Min.	Typ.	Max.		
SCLK Frequency	FSCLK	0.032	–	26	MHz	Full speed
		0.032	–	13	MHz	Half speed
SCLK Period	TSCLK	0.038	–	32	$\mu$ s	Full speed
		0.077	–	32	$\mu$ s	Half speed
SCLK Low Period	TSCLKIL	11.25	–	–	ns	Full speed, see Fig. 2
		24	–	–	ns	Half speed, see Fig. 2
SCLK High Period	TSCLKIH	11.25	–	–	ns	Full speed, see Fig. 2
		24	–	–	ns	Half speed, see Fig. 2
SDATA Setup Time	TS	1	–	–	ns	Full speed, see Fig. 3
		2	–	–	ns	Half speed, see Fig. 3
SDATA Hold Time	TH	5	–	–	ns	Full speed, see Fig. 3
		5	–	–	ns	Half speed, see Fig. 3
SDATA Release Time	TSDATAZ	–	–	10	ns	Full speed, see Fig. 4
		–	–	18	ns	Half speed, see Fig. 4
Time for Data Output	TD	–	–	10.25	ns	Full speed, see Fig. 5
		–	–	22	ns	Half speed, see Fig. 5
SDATA Rise/Fall Time	TSDATAOTR	2.1	–	6.5	ns	Full speed, see Fig. 5
		2.1	–	10	ns	Half speed, see Fig. 5
VIO Rise Time	TVIO-R	10	–	450	$\mu$ s	See Fig. 6
VIO Reset Time	TVIO-RST	10	–	–	$\mu$ s	See Fig. 6
Reset Delay Time	TSIGOL	0.12	–	–	$\mu$ s	See Fig. 6

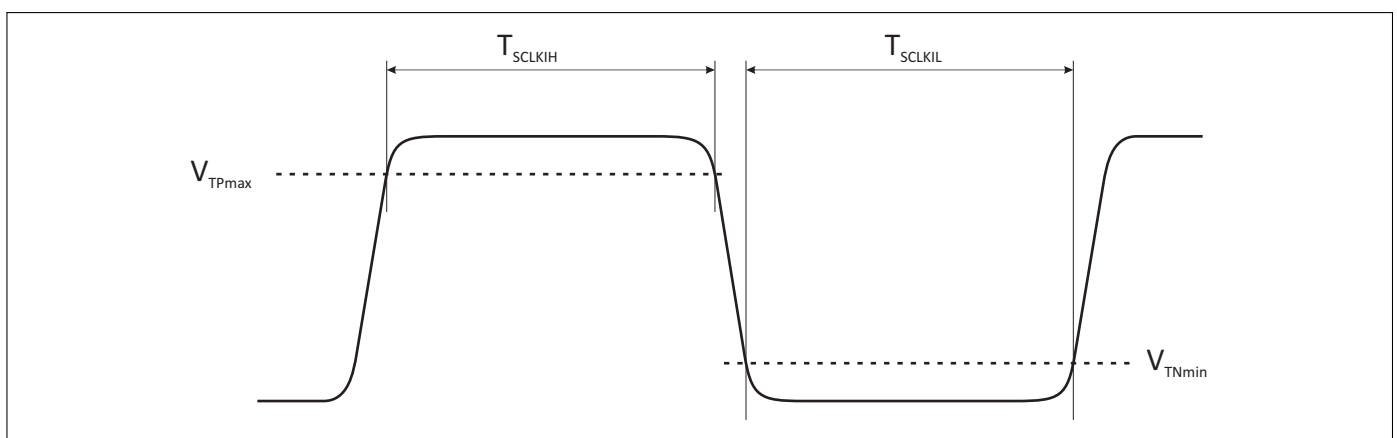
**Figure 2: Received clock signal constraints**

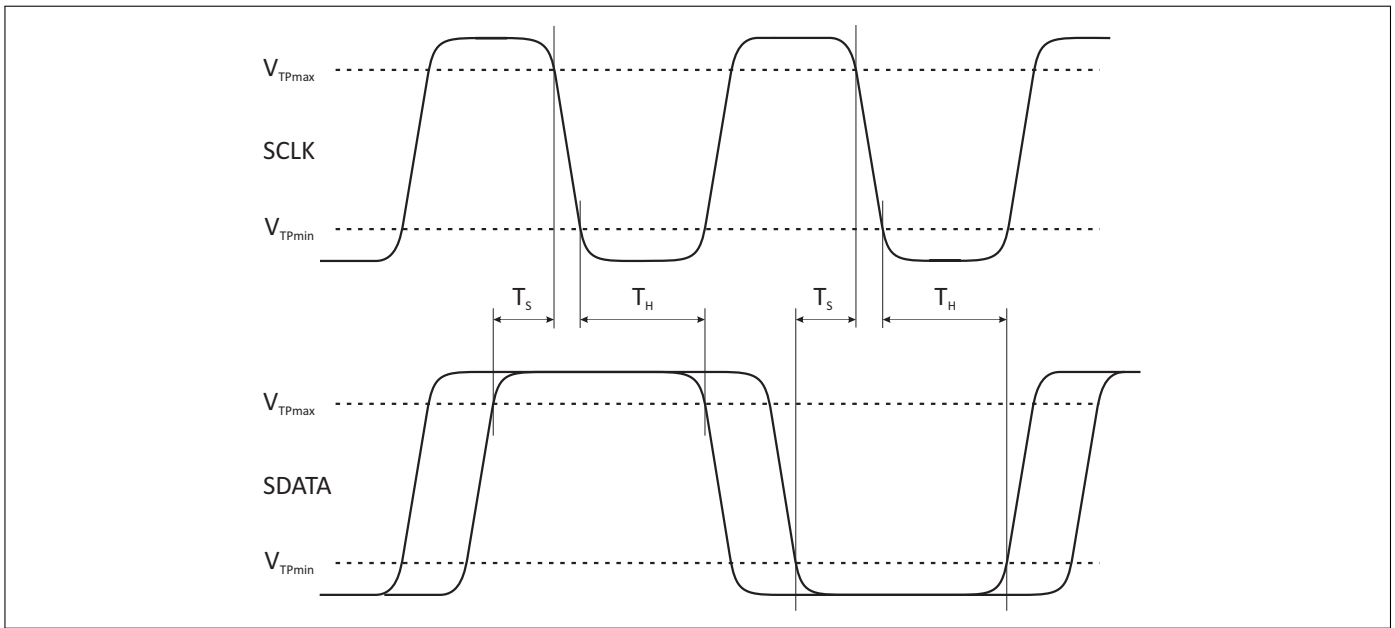

Figure 3: Bus active data receiver timing requirements

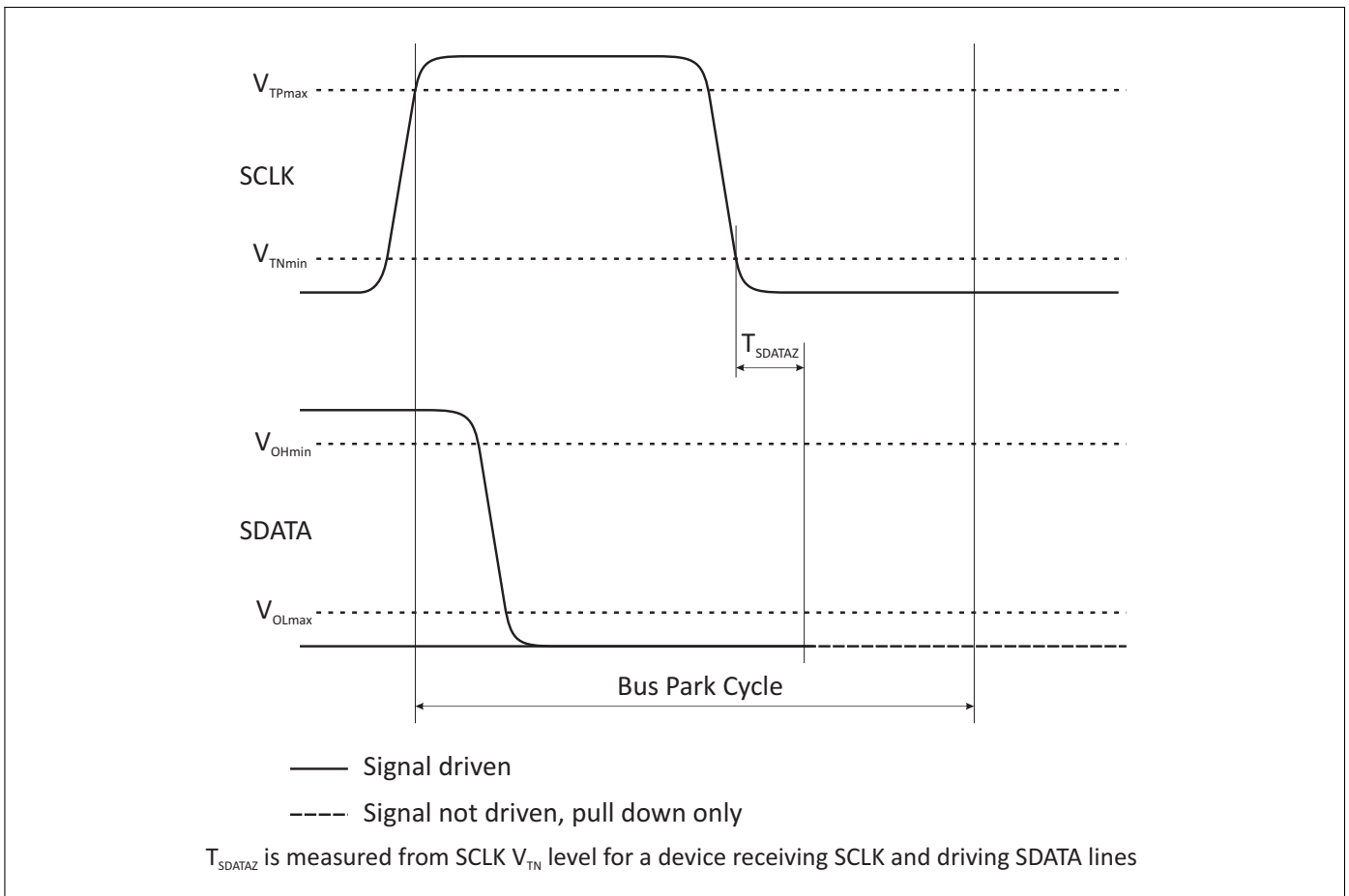

Figure 4: Bus park cycle timing

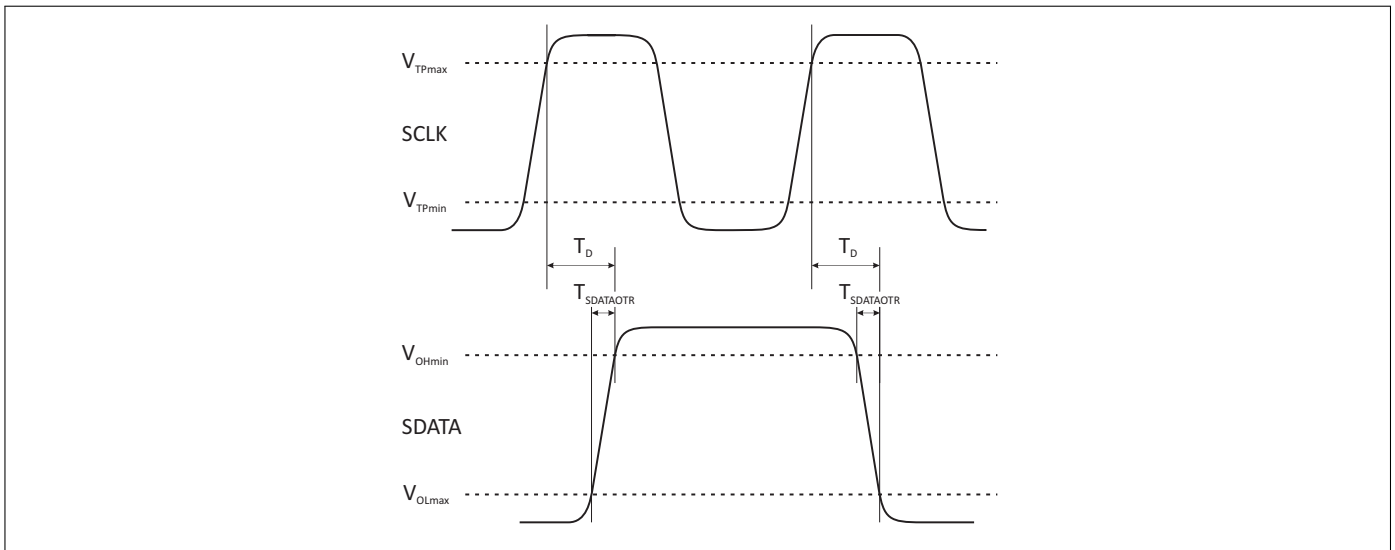

Figure 5: Bus active data transmission timing specification

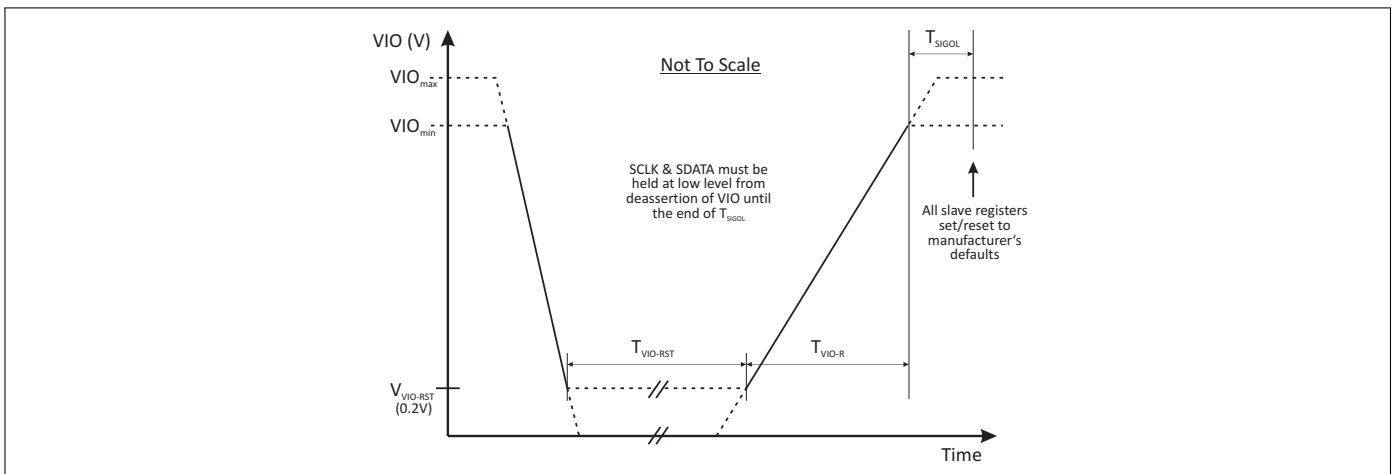

Figure 6: Requirements for VIO-initiated reset

Table 11: Register Mapping

Register Address	Register Name	Data Bits	Function	Description	Default	Broadcast_ID Support	Trigger Support	R/W
0x0000	REGISTER_0	7:0	MODE_CTRL	Module control	00000000	No	Yes	R/W
0x001D	PRODUCT_ID	7:0	PRODUCT_ID	This is a read-only register. However, during the programming of the USID a write command sequence is performed on this register, even though the write does not change its value.	11010010	No	No	R
0x001E	MANUFACTURER_ID	7:0	MANUFACTURER_ID [7:0]	This is a read-only register. However, during the programming of the USID, a write command sequence is performed on this register, even though the write does not change its value.	00011010	No	No	R

Continued on next page

**Table 11: Register Mapping – Continued from previous page**

Register Address	Register Name	Data Bits	Function	Description	Default	Broadcast_ID Support	Trigger Support	R/W
0x001C	PM_TRIG	7:6	PWR_MODE	00: Normal operation 01: Default settings (STARTUP) 10: Low power (LOW POWER) 11: Reserved	10	Yes	No	R/W
		5	TRIGGER_MASK_2	If this bit is set, trigger 2 is disabled. When all triggers disabled, if writing to a register that is associated to trigger 2, the data goes directly to the destination register.	0	No	No	
		4	TRIGGER_MASK_1	If this bit is set, trigger 1 is disabled. When all triggers disabled, if writing to a register that is associated to trigger 1, the data goes directly to the destination register.	0	No	No	
		3	TRIGGER_MASK_0	If this bit is set, trigger 0 is disabled. When all triggers disabled, if writing to a register that is associated to trigger 0, the data goes directly to the destination register.	0	No	No	
		2	TRIGGER_2	A write of a one to this bit loads trigger 2's registers.	0	Yes	No	
		1	TRIGGER_1	A write of a one to this bit loads trigger 1's registers.	0	Yes	No	R/W
		0	TRIGGER_0	A write of a one to this bit loads trigger 0's registers.	0	Yes	No	
0x001F	MAN_USID	7:6	SPARE	These are read-only bits that are reserved and yield a value of 0b00 at readback.	00	No	No	R/W
		5:4	MANUFACTURER_ID [9:8]	These bits are read-only. However, during the programming of the USID, a write command sequence is performed on this register even though the write does not change its value.	01			
		3:0	USID	Programmable USID. Performing a write to this register using the described programming sequences will program the USID in devices supporting this feature. These bits store the USID of the device.	0010			
0x001A	RFFE_STATUS	7	SOFTWARE RESET	0: Normal operation 1: Software reset	0	No	No	R/W
		6	COMMAND_FRAME_PARITY_ERR	Command sequence received with parity error - discard command.	0	No	No	R
		5	COMMAND_LENGTH_ERR	Command length error	0			
		4	ADDRESS_FRAME_PARITY_ERR	Address frame parity error = 1	0			
		3	DATA_FRAME_PARITY_ERR	Data frame with parity error	0			
		2	READ_UNUSED_REG	Read command to an invalid address	0			
		1	WRITE_UNUSED_REG	Write command to an invalid address	0			
		0	BID_GID_ERR	Read command with a BROADCAST_ID or GROUP_SID	0			
0x001B	GROUP_SID	7:4	RESERVED		0	No	No	R/W
		3:0	GROUP_SID	Group slave ID	0			

**Table 12: Modes of Operation (Truth Table, Register\_0)**

State	Mode	REGISTER_0 Bits							
		D7	D6	D5	D4	D3	D2	D1	D0
1	Isolation	x	x	x	0	0	0	0	0
2	RX1-AO	x	x	x	0	0	0	0	1
3	RX2-AO	x	x	x	0	0	0	1	0
4	RX3-AO	x	x	x	0	1	0	0	0
5	RX4-AO	x	x	x	0	0	1	0	0
6	RX5-AO	x	x	x	1	0	0	0	0
7	RX1&RX2-AO	x	x	x	0	0	0	1	1
8	RX2&RX3-AO	x	x	x	0	1	0	1	0
9	RX3&RX4-AO	x	x	x	0	1	1	0	0
10	RX4&RX5-AO	x	x	x	1	0	1	0	0
11	RX1&RX3-AO	x	x	x	0	1	0	0	1
12	RX2&RX4-AO	x	x	x	0	0	1	1	0
13	RX3&RX5-AO	x	x	x	1	1	0	0	0
14	RX1&RX4-AO	x	x	x	0	0	1	0	1
15	RX2&RX5-AO	x	x	x	1	0	0	1	0
16	RX1&RX5-AO	x	x	x	1	0	0	0	1

## 7 Application Information

### Pin Configuration and Function

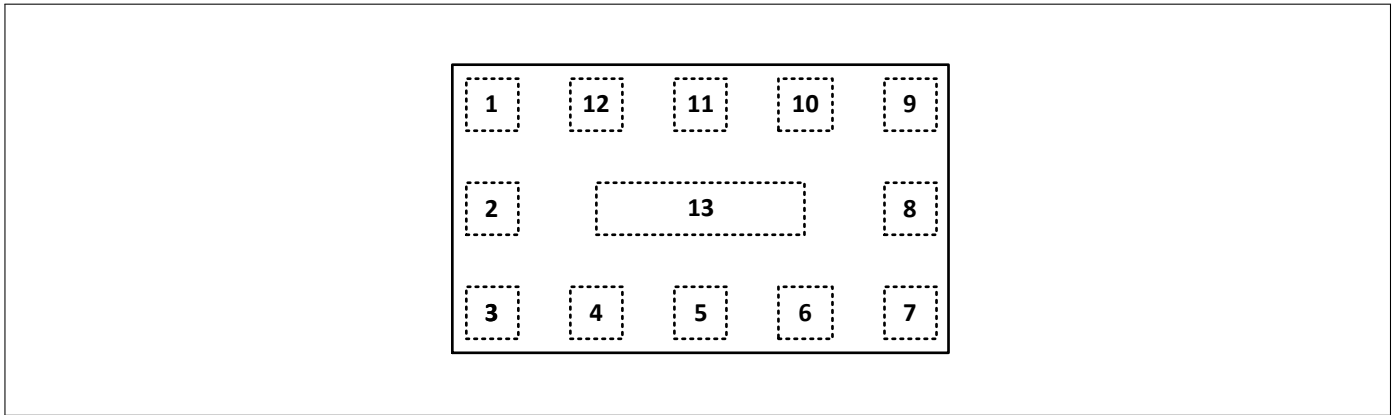
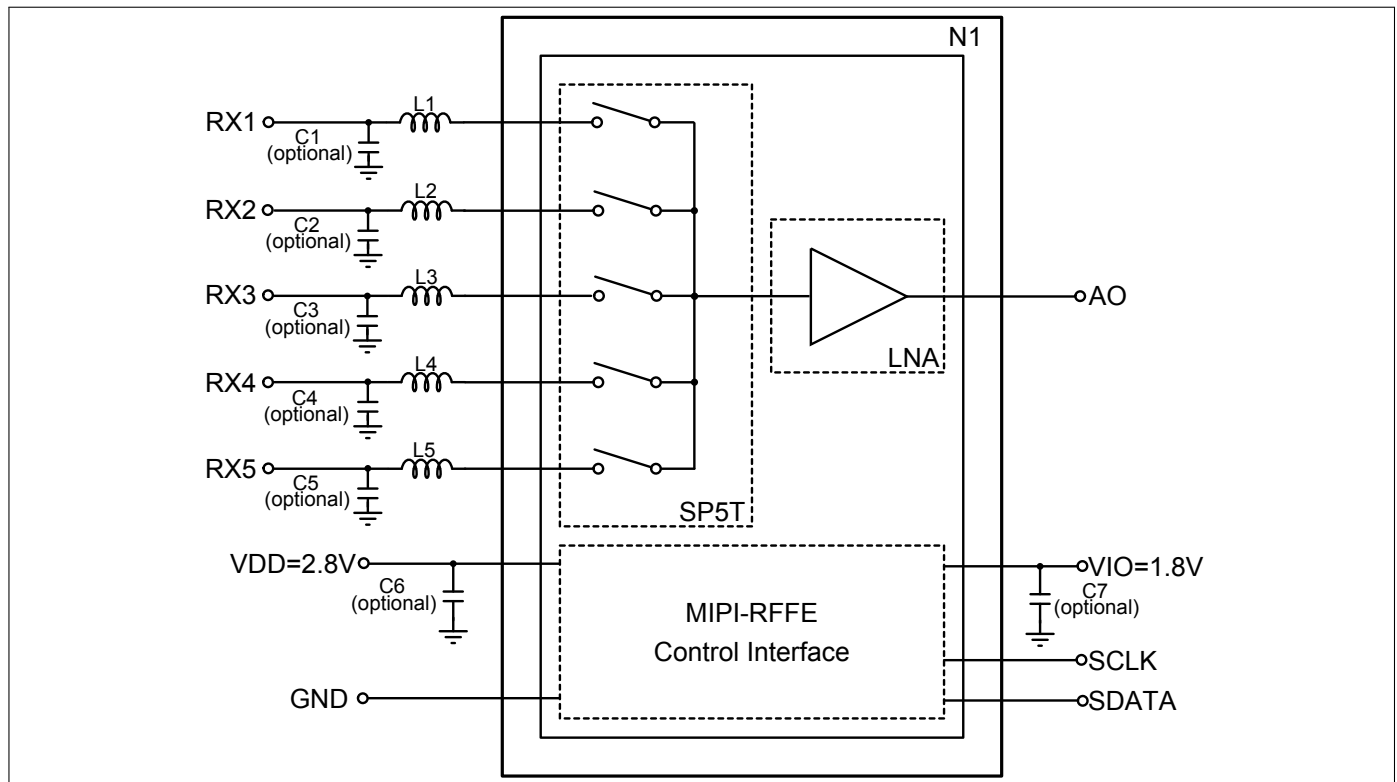

Figure 7: BGM15MA12 Pin Configuration (top view)

Table 13: Pin Definition and Function

Pin No.	Name	Function
1	SCLK	MIPI RFFE Clock
2	VIO	MIPI RFFE Power Supply
3	RX5	RF-Port RX No. 5
4	RX4	RF-Port RX No. 4
5	RX3	RF-Port RX No. 3
6	RX2	RF-Port RX No. 2
7	RX1	RF-Port RX No. 1
8	GND	Ground
9	GND	Ground
10	AO	RF-Output Port
11	VDD	Power Supply
12	SDATA	MIPI RFFE Data IO
13	GND	Ground

## Application Board Configuration



**Figure 8:** BGM15MA12 Application Schematic

**Table 14: Bill of Materials Table**

Name	Value	Package	Manufacturer	Function
C1 (optional)	tbd.	tbd.	Various	Input matching <sup>2)</sup>
C2 (optional)	tbd.	tbd.	Various	Input matching <sup>2)</sup>
C3 (optional)	1.6 pF	0402	Various	Input matching Band 3 <sup>2)</sup>
C4 (optional)	1.5 pF	0402	Various	Input matching Band 2 <sup>2)</sup>
C5 (optional)	1.6 pF	0402	Various	Input matching Band 1 <sup>2)</sup>
C6 (optional)	1 nF	0402	Various	RF Bypass <sup>1)</sup>
C7 (optional)	1 nF	0402	Various	RF Bypass <sup>1)</sup>
L1	tbd.	tbd.	Various	Input matching <sup>2)</sup>
L2	tbd.	tbd.	Various	Input matching <sup>2)</sup>
L3	5.1 nH	0402	Various	Input matching Band 3 <sup>2)</sup>
L4	4.3 nH	0402	Various	Input matching Band 2 <sup>2)</sup>
L5	3.6 nH	0402	Various	Input matching Band 1 <sup>2)</sup>
N1	BGM15MA12	ATSLP-12-2	Infineon	LNA Multiplexer Module

<sup>1)</sup>RF bypass recommended to mitigate power supply noise.

<sup>2)</sup>The matching elements must be optimized with reference to the frequency band of interest. Each band can be arbitrarily assigned to an RF port. The configuration shown in the table is only an example of the port assignment.

## 8 Package Information

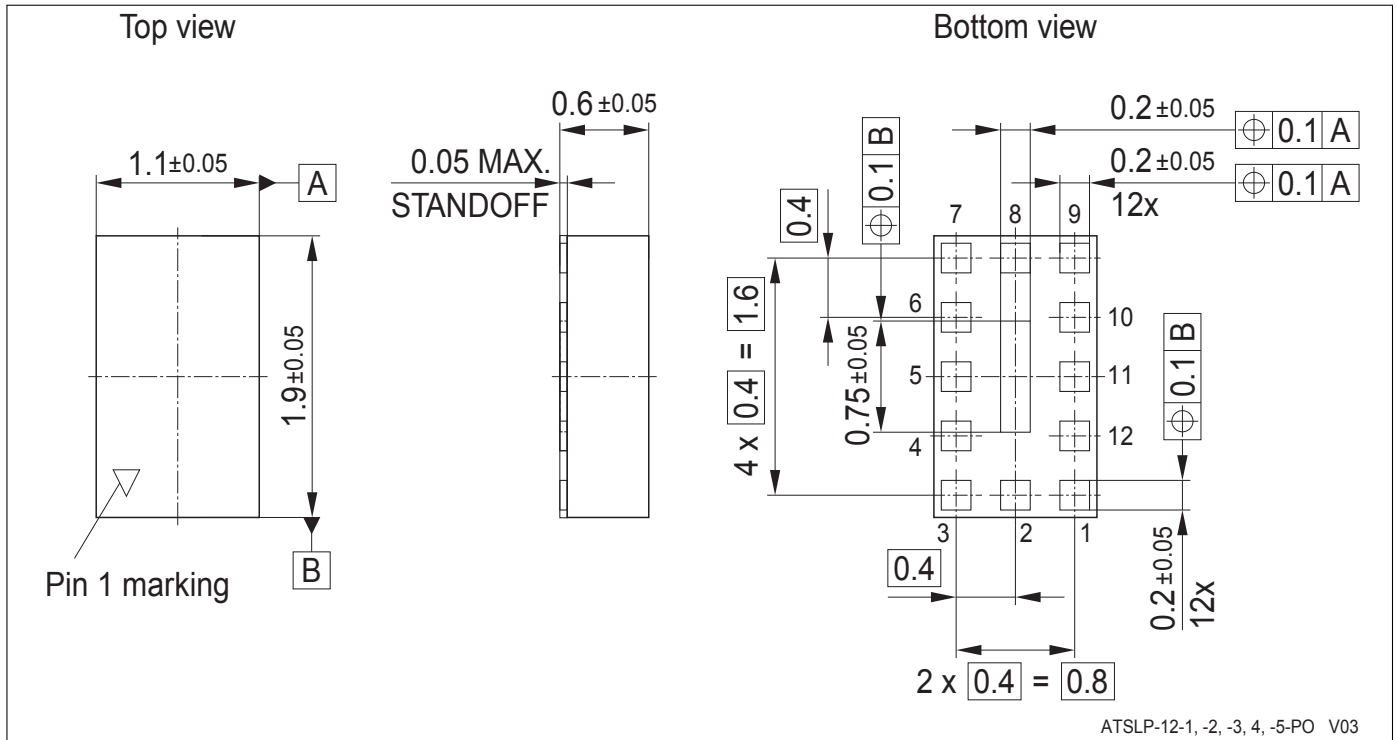

Figure 9: ATSLP-12-2 Package Outline (top, side and bottom views)

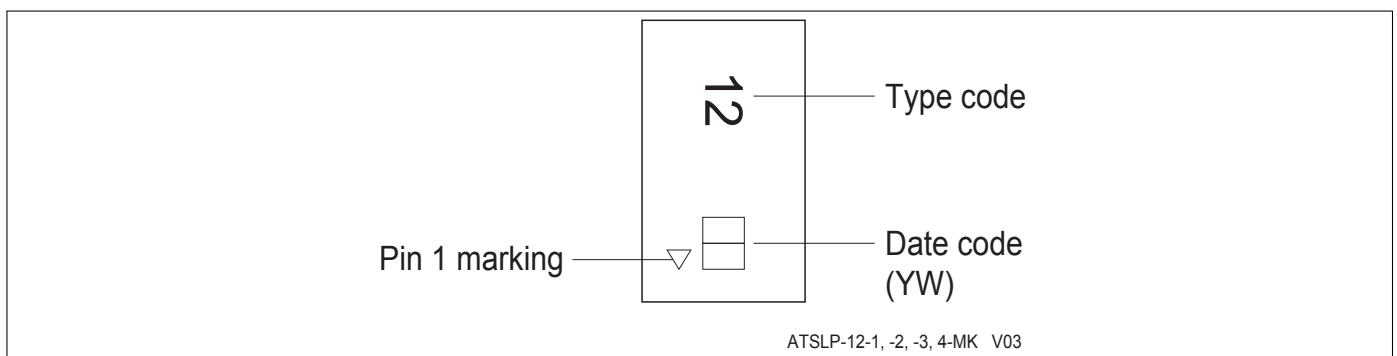

Figure 10: Marking Specification (top view)

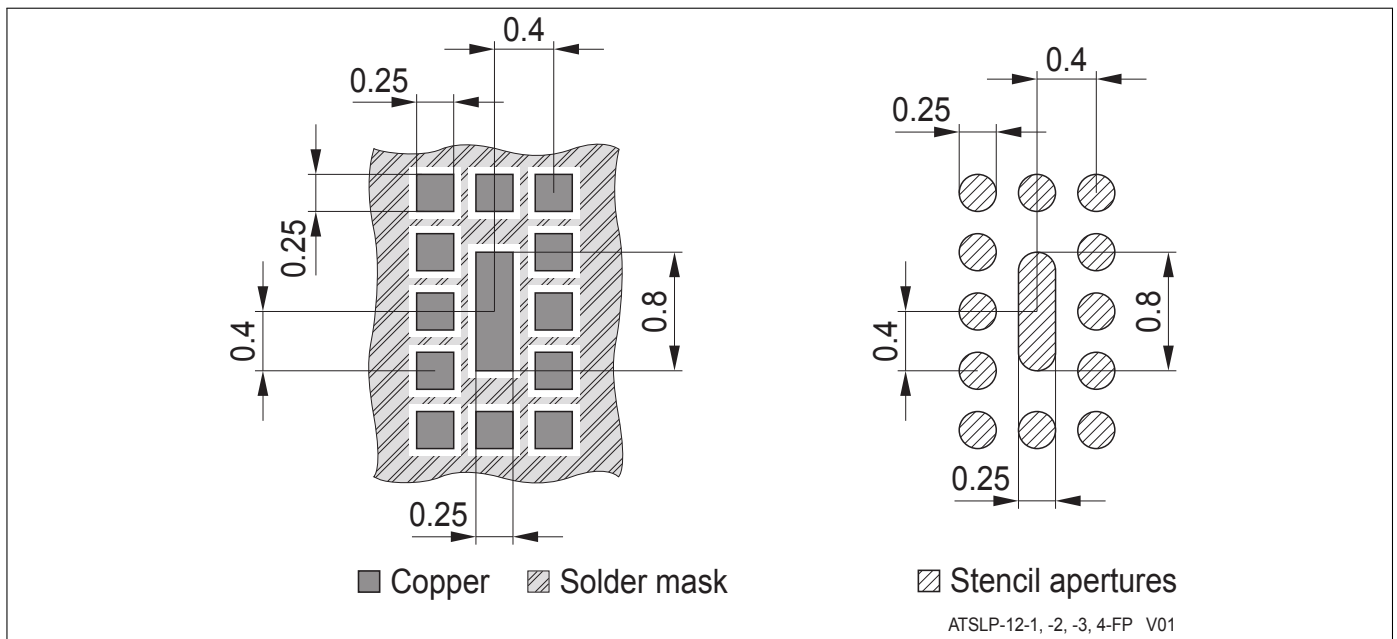

Figure 11: Footprint Recommendation

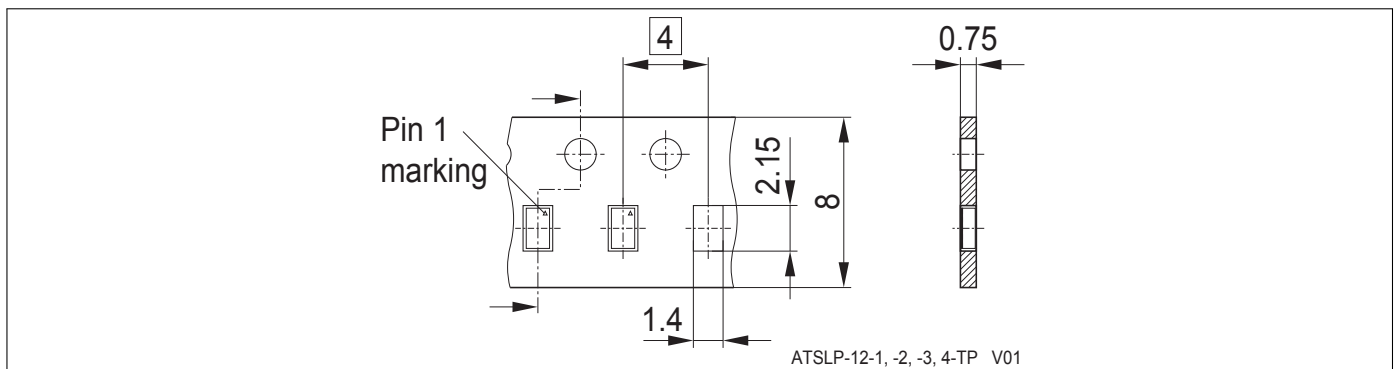



Figure 12: ATSLP-12-2 Carrier Tape

[www.infineon.com](http://www.infineon.com)

Published by Infineon Technologies AG

## Looking for pricing, stock, or lifecycle information?

Click below to explore more details on WIN SOURCE:

-  [View BGM15MA12E6327XTSA1 on WIN SOURCE](#)
-  [Infineon Technologies Information](#)

## Optimize Your Supply Chain with WIN SOURCE Solutions

-  Global Sourcing Solution
-  Obsolete Management
-  Cost Control Management
-  Shortage Management
-  Alternative Solution
-  Excess Inventory Management