

REV.	DESCRIPTION	DATE	APPROVED
C	Engineering Update w/o Changes	03/10/04	M. C.
D	Corrected Typos.	08/19/04	M. C.
E	Included Charts as Page 3, 4 & 5.	10/21/04	M. C.
F	Changed Storage & Operating Lower Temperature to -40.	11/02/04	M. C.
G	Image Orientation Update w/o Changes	02/28/05	M. C.
H	Added SM2-PGC-20 LED	09/29/06	M. C.

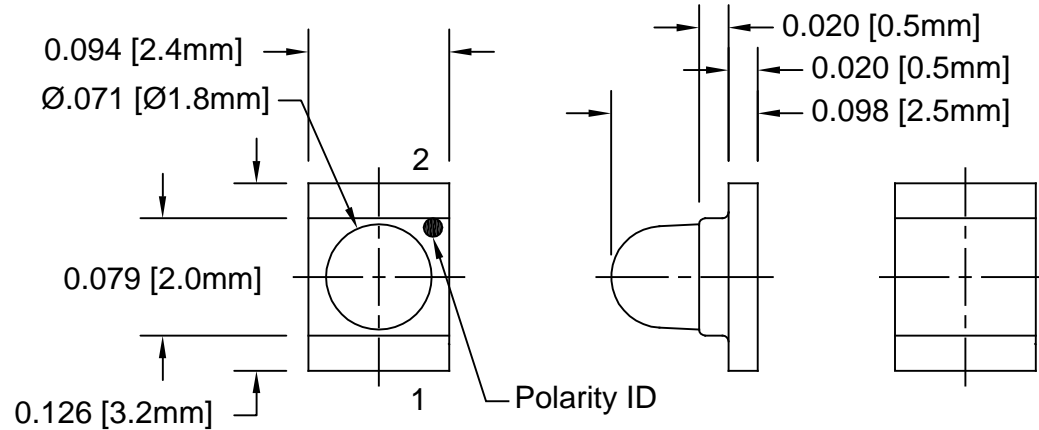

SM2-XXXX-20

*REVERSE POLARITY

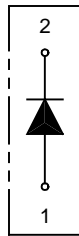

SM2-XXXX-20

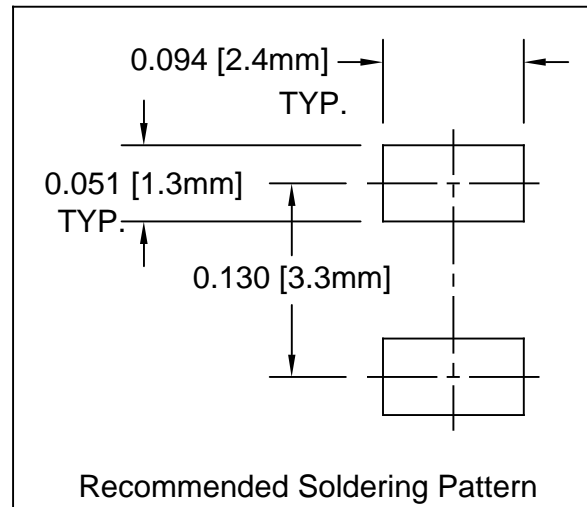

ABSOLUTE MAXIMUM RATINGS (Ta=25° C)



REVERSE VOLTAGE	_____	5V
REVERSE CURRENT	_____	100uA
OPERATING TEMPERATURE RANGE	_____	-40° C - 85° C
STORAGE TEMPERATURE	_____	-40° C - 100° C
LEAD SOLDERING TEMPERATURE(1/16" FROM BODY)	_____	260° C FOR 5 SECONDS

STANDARD TOLERANCE (UNLESS OTHERWISE SPECIFIED)		 4 THOMAS, IRVINE, CA. 92618 TEL: (949) 951-8808 FAX: (949) 951-3974	
DECIMALS	ANGULAR		
.X ± .1	X° ± 1°		
.XX ± .02		 TITLE: SURFACE MOUNT LED, 1.8mm DOMED LENS	
.XXX ± .010			
DESIGNED: David Green	DATE: 10/21/02	PART NO: SM2-XXXX-20 REVISION: H	
CHECKED: M. Chen	DATE: 10/21/02		
		CAGE CODE : 32559 SHEET # 1 OF 6 <small>CAD GENERATED DOCUMENT, DO NOT MEASURE DRAWING.</small>	

REV.	DESCRIPTION	DATE	APPROVED
	SEE SHEET#1.		

LED Part No.	Chip			Lens Appearance	Absolute Max. Ratings				Electro-Optical Data @ 20mA			Viewing Angle 2θ ½ (Deg)
	Material	Peak Wave Length λp(nm)	Emitted Color		Δλ (nm)	Pd (mW)	If (mA)	Peak If(mA)	Vf (V)		Iv (mcd)	
									TYP	MAX	TYP	
SM2-SBWC-20	GaN/Sic	430	SUPER BLUE	WATER CLEAR	60	150	30	150	4.0	4.5	64	20
SM2-UBWC-20	GaN	460	ULTRA BLUE	WATER CLEAR	68	150	30	150	3.4	4.0	288	20
SM2-UTC-20	InGaN	505	ULTRA TURQUOISE	WATER CLEAR	37	150	30	150	3.3	4.0	960	20
SM2-PGC-20	InGaN/SiC	510	GREEN	WATER CLEAR	20	120	30	125	3.5	4.0	900	20
SM2-UGC-20	InGaN	525	ULTRA GREEN	WATER CLEAR	40	150	30	150	3.2	3.8	960	20
SM2-GC-20	GaP	565	GREEN	WATER CLEAR	32	100	30	150	2.3	2.7	136	20
SM2-SGC-20	AlGaN	575	GREEN	WATER CLEAR	18	100	30	150	2.1	2.6	296	20
SM2-YC-20	GaAsP	586	YELLOW	WATER CLEAR	37	100	30	150	2.1	2.5	49	20
SM2-UYC-20	AlGaN	595	YELLOW	WATER CLEAR	32	100	30	150	2.0	2.5	456	20
SM2-UAC-20	AlGaN	600	AMBER	WATER CLEAR	20	100	30	150	1.9	2.4	600	20
SM2-SAC-20	AlGaN	610	AMBER	WATER CLEAR	25	100	30	150	1.9	2.4	416	20
SM2-UOC-20	AlGaN	620	ORANGE	WATER CLEAR	18	100	30	150	1.9	2.4	600	20
SM2-UHC-20	AlGaN	635	HE RED	WATER CLEAR	25	100	30	150	1.9	2.4	536	20
SM2-SHC-20	AlGaN	640	RED	WATER CLEAR	23	80	30	150	1.9	2.4	416	20
SM2-ERC-20*	GaAlAs	660	RED	WATER CLEAR	25	80	30	150	1.8	2.3	152	20
SM2-UWC-20	GaN	X=.29 Y=.30	WHITE	WATER CLEAR	-	150	30	150	3.4	4.0	250	60

*ERC CHIP REVERSED POLARITY

STANDARD TOLERANCE (UNLESS OTHERWISE SPECIFIED) ±10% ALL VALUES ANGULAR X° ± 5°		 BIVAR [®] 4 THOMAS, IRVINE, CA. 92618 TEL: (949) 951-8808 FAX: (949) 951-3974	
			
DESIGNED: David Green	DATE: 10/21/02	PART NO: SM2-XXXX-20	REVISION: H
CHECKED: M. Chen	DATE: 10/21/02		CAGE CODE : 32559 SHEET # 2 OF 6

REV.	DESCRIPTION	DATE	APPROVED
	SEE SHEET#1.		

Relative Intensity vs. Wavelength

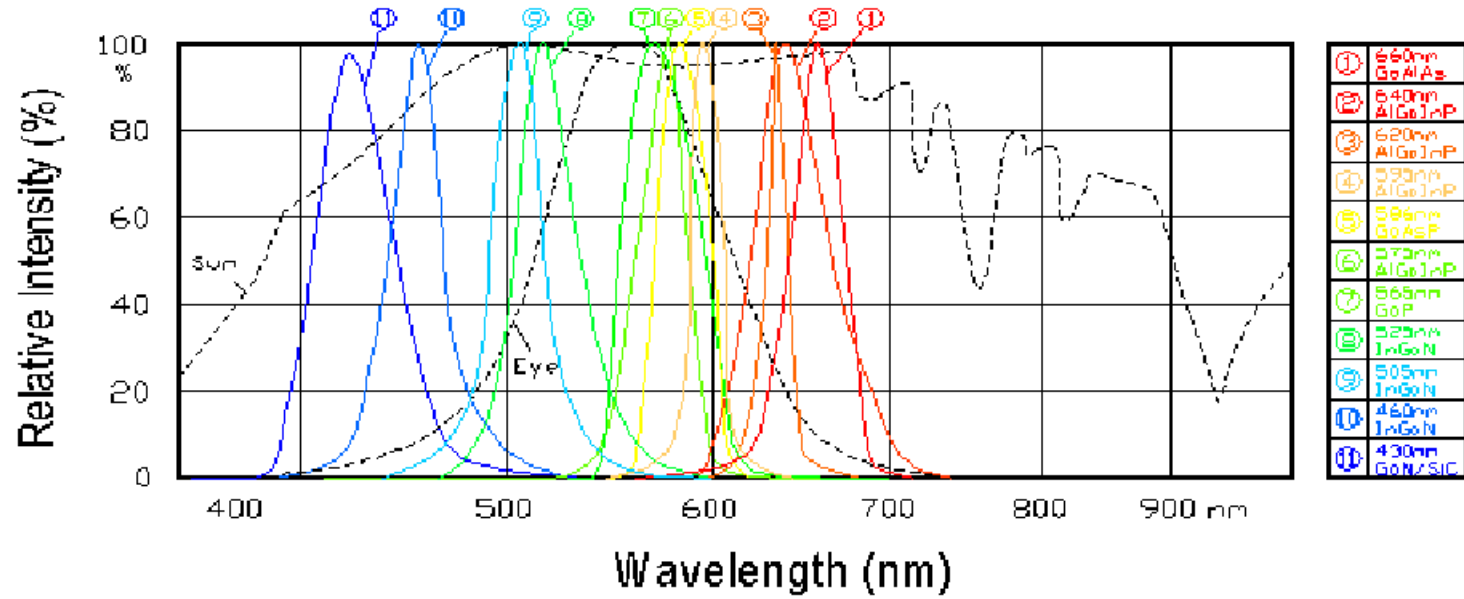

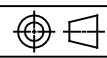
STANDARD TOLERANCE (UNLESS OTHERWISE SPECIFIED) ±10% ALL VALUES		 BIVAR [®] 4 THOMAS, IRVINE, CA. 92618 TEL: (949) 951-8808 FAX: (949) 951-3974		
ANGULAR X° ± 5°				
		TITLE: SURFACE MOUNT LED, 1.8mm DOMED LENS		
		DESIGNED: David Green	DATE: 10/21/02	PART NO: SM2-XXXX-20
CHECKED: M. Chen		DATE: 10/21/02	CAGE CODE : 32559 SHEET # 3 OF 6	
CAD GENERATED DOCUMENT, DO NOT MEASURE DRAWING.				

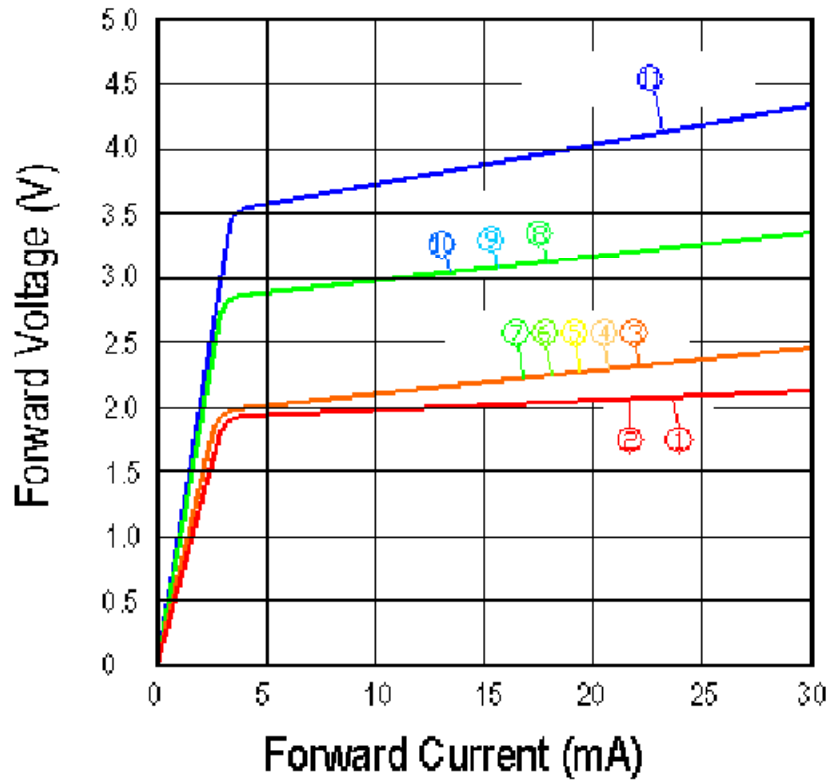

REV.	DESCRIPTION	DATE	APPROVED
	SEE SHEET#1.		

Forward Voltage vs. Forward Current

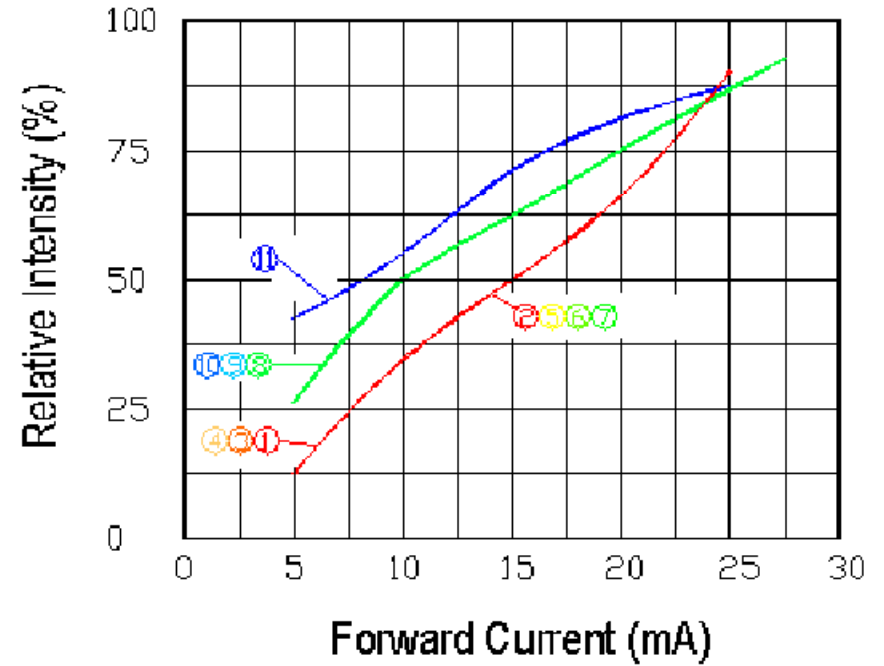

Relative Intensity vs. Forward Current



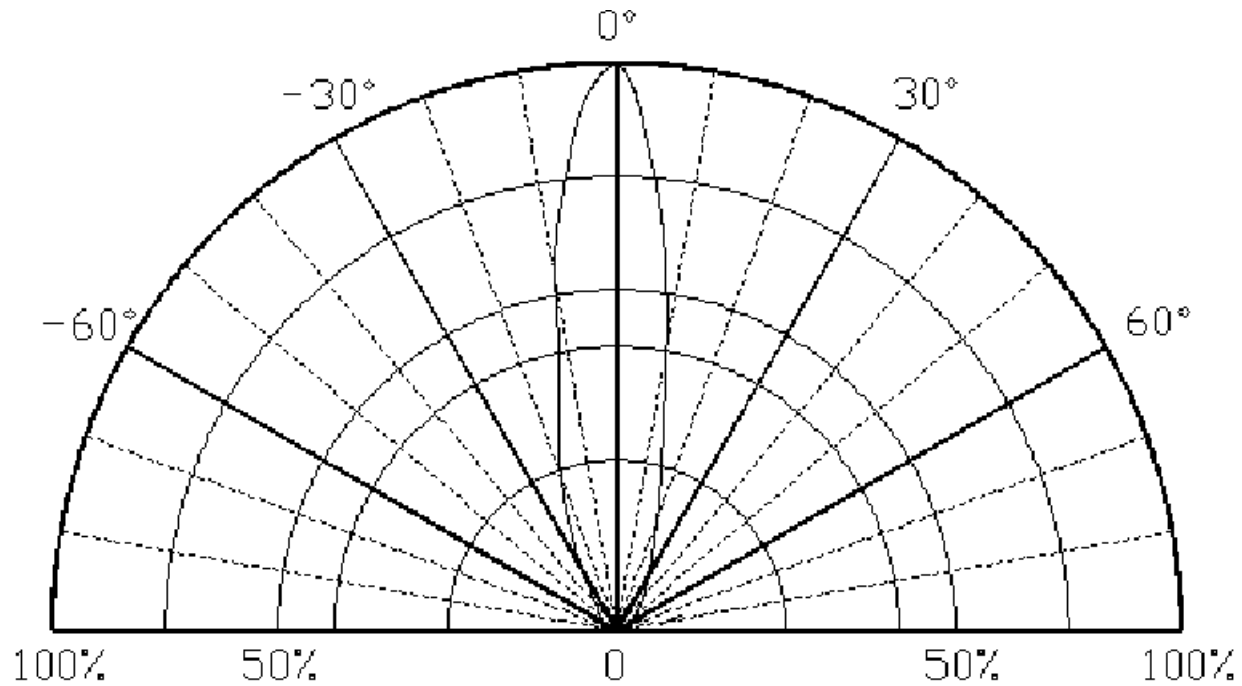

STANDARD TOLERANCE (UNLESS OTHERWISE SPECIFIED) ±10% ALL VALUES ANGULAR X° ± 5°		 4 THOMAS, IRVINE, CA. 92618 TEL: (949) 951-8808 FAX: (949) 951-3974		
				TITLE: SURFACE MOUNT LED, 1.8mm DOMED LENS
DESIGNED: David Green	DATE: 10/21/02	PART NO: SM2-XXXX-20		REVISION: H
CHECKED: M. Chen	DATE: 10/21/02	CAGE CODE : 32559	SHEET # 4 OF 6	
CAD GENERATED DOCUMENT, DO NOT MEASURE DRAWING.				

REV.	DESCRIPTION	DATE	APPROVED
	SEE SHEET#1.		



Directive Characteristics

STANDARD TOLERANCE (UNLESS OTHERWISE SPECIFIED) ±10% ALL VALUES		ANGULAR X° ± 5°	
		 4 THOMAS, IRVINE, CA. 92618 TEL: (949) 951-8808 FAX: (949) 951-3974	
		 TITLE: SURFACE MOUNT LED, 1.8mm DOMED LENS	
DESIGNED: David Green	DATE: 10/21/02	PART NO: SM2-XXXX-20	REVISION: H
CHECKED: M. Chen	DATE: 10/21/02	CAGE CODE : 32559	SHEET # 5 OF 6
CAD GENERATED DOCUMENT. DO NOT MEASURE DRAWING.			

REV.	DESCRIPTION	DATE	APPROVED
	See Sheet #1.		

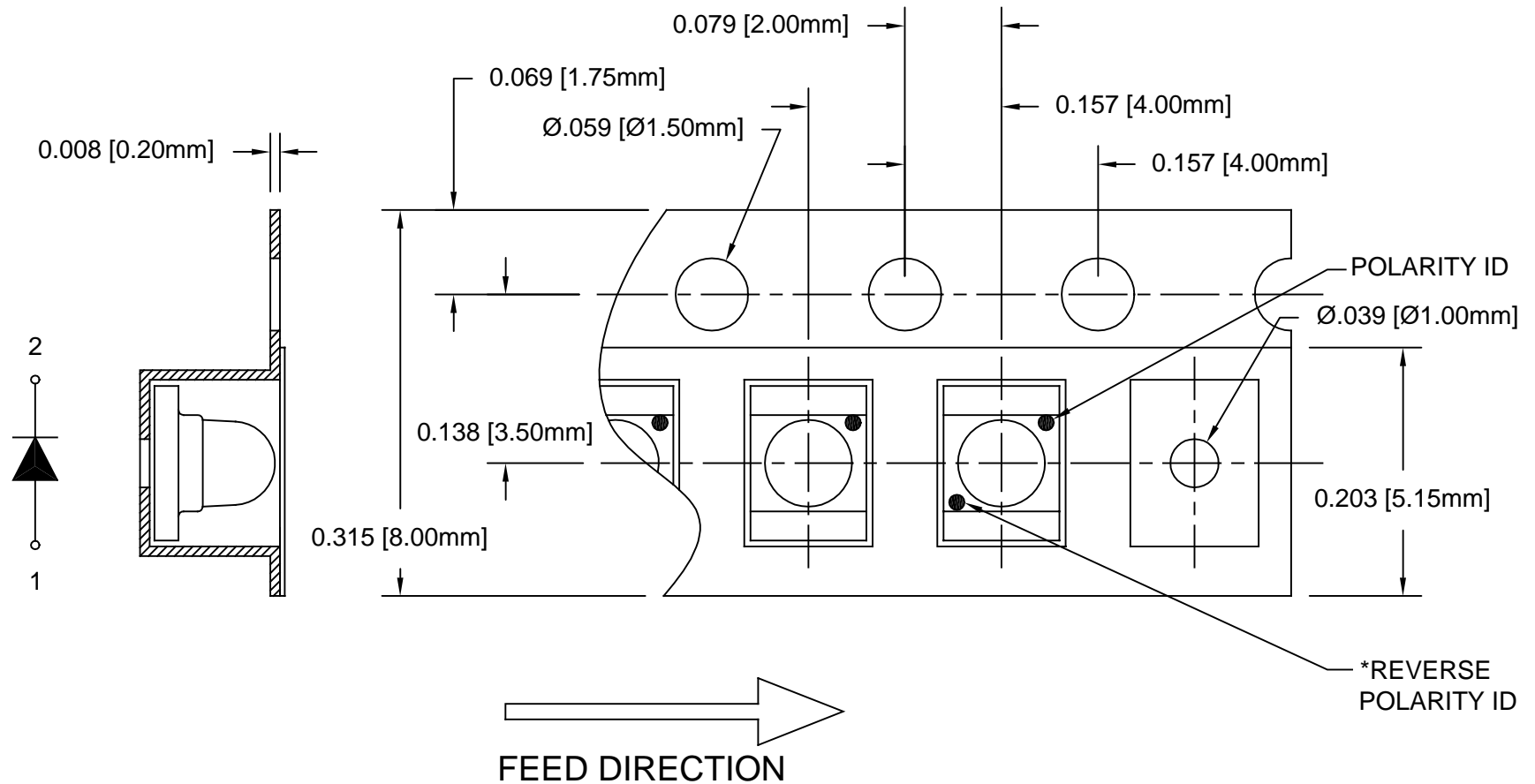

2. UNLESS OTHERWISE SPECIFIED,
PACKAGING TO COMPLY WITH EIA-481
1. 1500 pcs PER REEL

STANDARD TOLERANCE (UNLESS OTHERWISE SPECIFIED)		BIVAR [®]	
DECIMALS	ANGULAR	4 THOMAS, IRVINE, CA. 92618	
.X ± .1	X° ± 1°	TEL: (949) 951-8808 FAX: (949) 951-3974	
.XX ± .02		TITLE: SURFACE MOUNT LED, 1.8mm DOMED LENS	
.XXX ± .010		PART NO: SM2-XXXX-20	
DESIGNED: David Green	DATE: 10/21/02	REVISION: H	
CHECKED: M. Chen	DATE: 10/21/02	CAGE CODE : 32559 SHEET # 6 OF 6	
CAD GENERATED DOCUMENT, DO NOT MEASURE DRAWING.			

Looking for pricing, stock, or lifecycle information?

Click below to explore more details on WIN SOURCE:

 [View SM2-UAC-20 on WIN SOURCE](#)

 [Bivar Inc. Information](#)

Optimize Your Supply Chain with WIN SOURCE Solutions

-  Global Sourcing Solution
-  Obsolete Management
-  Cost Control Management
-  Shortage Management
-  Alternative Solution
-  Excess Inventory Management