

### Product Overview

The CMD249P5 is wideband GaAs MMIC distributed power amplifier housed in a leadless 5x5 mm plastic surface mount package. The amplifier delivers 12.5 dB of gain with a corresponding output 1 dB compression point of +28 dBm and an output IP3 of 39 dBm at 10 GHz. The CMD249P5 is a 50 ohm matched design which eliminates the need for RF port matching.

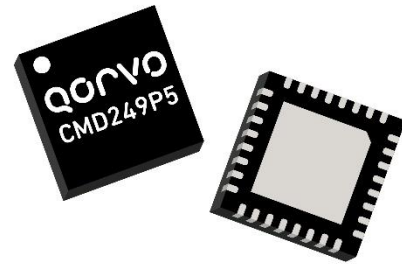

### Functional Block Diagram

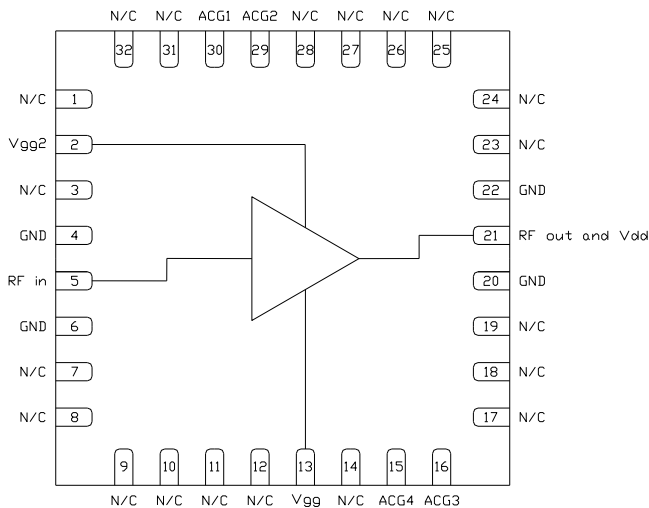

Note:  $V_{gg2}$  is optional for gain control

### Key Features

- Ultra Wideband Performance
- High Linearity
- High Output Power
- Excellent Return Losses
- Pb-Free RoHS Compliant 5x5 QFN Package

### Ordering Information

Part No.	Description
CMD249P5	50 Piece 7" Reel
CMD249P5-EVB	1 Piece Bag

### Electrical Performance ( $V_{dd} = 10.0\text{ V}$ , $V_{gg} = -0.55\text{ V}$ , $T_A = 25^\circ\text{ C}$ , $F = 10\text{ GHz}$ )

Parameter	Min	Typ	Max	Units
Frequency Range		DC - 20		GHz
Gain		12.5		dB
Noise Figure		3		dB
Input Return Loss		15		dB
Output Return Loss		15		dB
Output P1dB		28		dBm
Output IP3		39		dBm
Output IP2		38		dBm
Supply Current		400		mA

## Absolute Maximum Ratings

Parameter	Rating
Drain Voltage, $V_{dd}$	10.5 V
Gate1 Voltage, $V_{gg}$	-2.0 to 0 V
RF Input Power	+30 dBm
Channel Temperature, $T_{ch}$	150° C
Power Dissipation, $P_{diss}$	4.924 W
Thermal Resistance, $Q_{JC}$	13.2° C/W
Operating Temperature	-40 to 85° C
Storage Temperature	-55 to 150° C

Exceeding any one or combination of the maximum ratings may cause permanent damage to the device.

## Recommended Operating Conditions

Parameter	Min	Typ	Max	Units
$V_{dd}$	8.0	10.0	10.5	V
$I_{dd}$	350	400	450	mA
$V_{gg1}$		-0.55		V

Electrical performance is measured at specific test conditions. Electrical specifications are not guaranteed over all recommended operating conditions.

## Electrical Specifications ( $V_{dd} = 10.0$ V, $V_{gg} = -0.55$ V, $T_A = 25^\circ$ C)

Parameter	Min	Typ	Max	Min	Typ	Max	Units
Frequency Range		DC - 6			6 - 20		GHz
Gain	8	11		9	13		dB
Noise Figure		5			3.5		dB
Input Return Loss		13			18		dB
Output Return Loss		9			13		dB
Output P1dB	25	28		20	27		dBm
Output IP3		42			38		dBm
Output IP2		40			40		dBm
Supply Current	350	400	450	350	400	450	mA
Gain Temperature Coefficient		0.008			0.012		dB/°C
Noise Figure Temperature Coefficient		0.01			0.012		dB/°C

Typical Performance

Broadband Performance,  $V_{dd} = 10\text{ V}$ ,  $V_{gg} = -0.55\text{ V}$ ,  $I_{dd} = 380\text{ mA}$ ,  $T_A = 25^\circ\text{ C}$

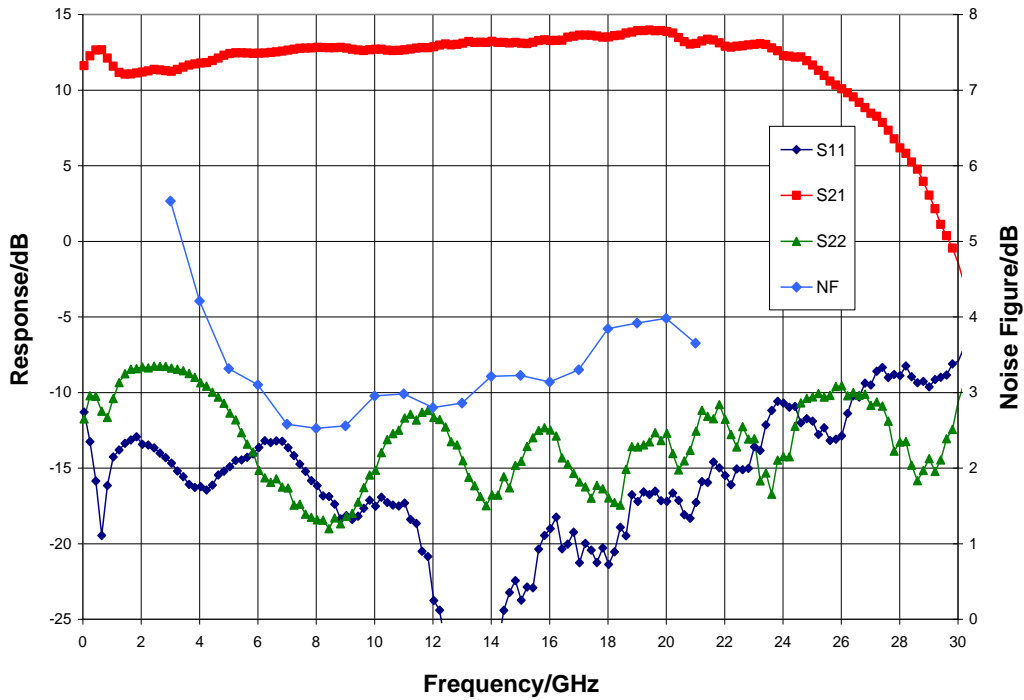

Narrow-band Performance,  $V_{dd} = 10\text{ V}$ ,  $V_{gg} = -0.55\text{ V}$ ,  $I_{dd} = 380\text{ mA}$ ,  $T = 25^\circ\text{ C}$

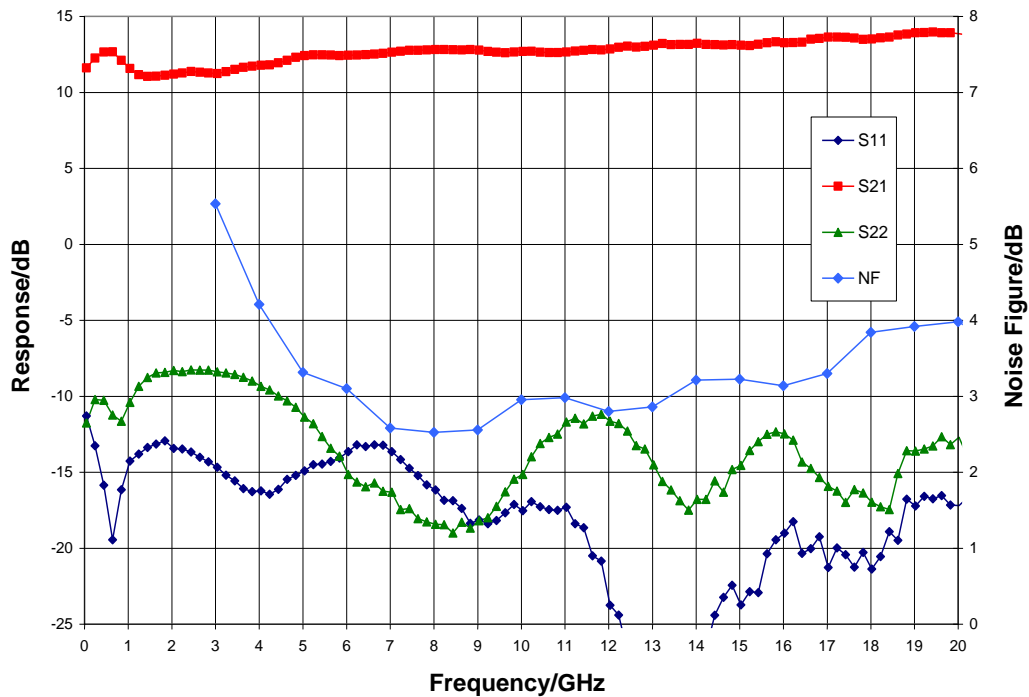

Typical Performance

Gain vs. Temperature,  $V_{dd} = 10\text{ V}$ ,  $V_{gg} = -0.55\text{ V}$

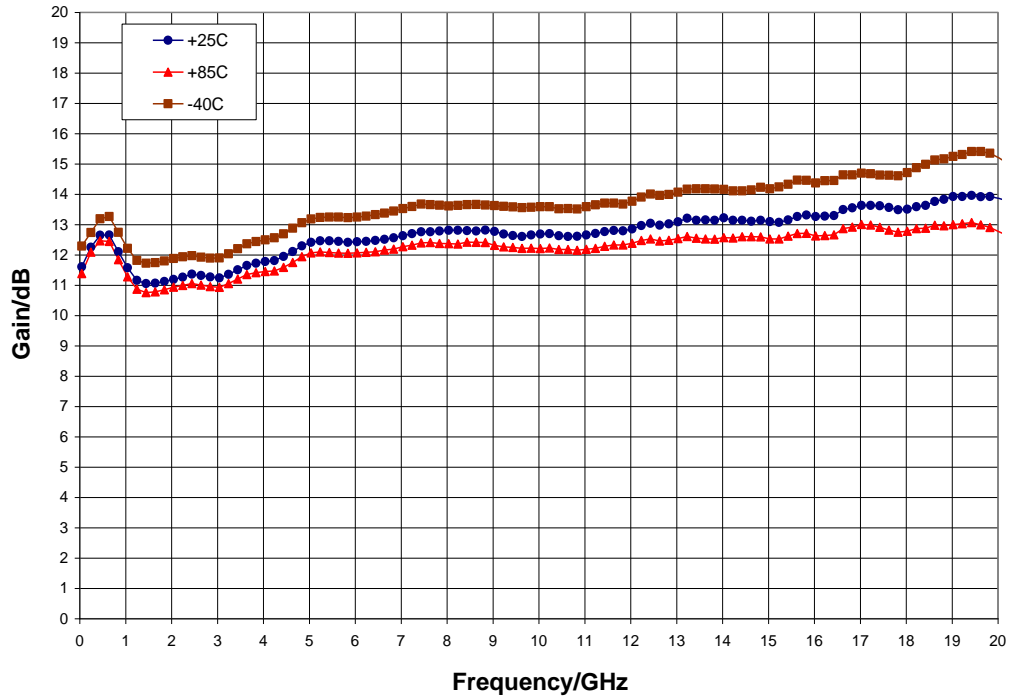

Gain vs.  $V_{dd}$ ,  $T_A = 25^\circ\text{ C}$

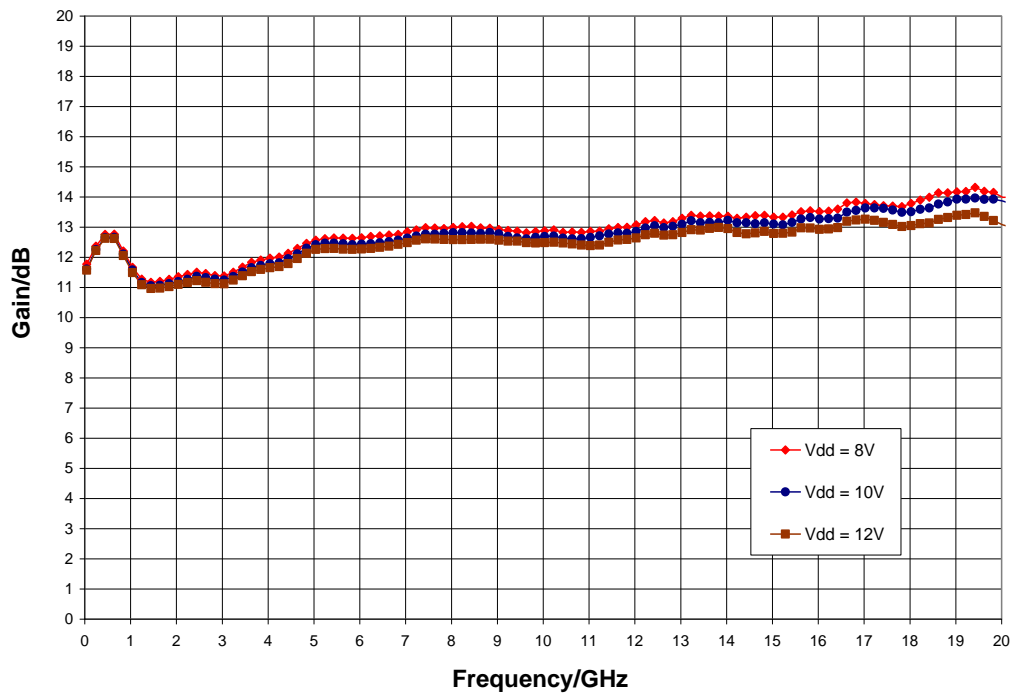

Typical Performance

Noise Figure vs. Temperature,  $V_{dd} = 10\text{ V}$ ,  $V_{gg} = -0.55\text{ V}$

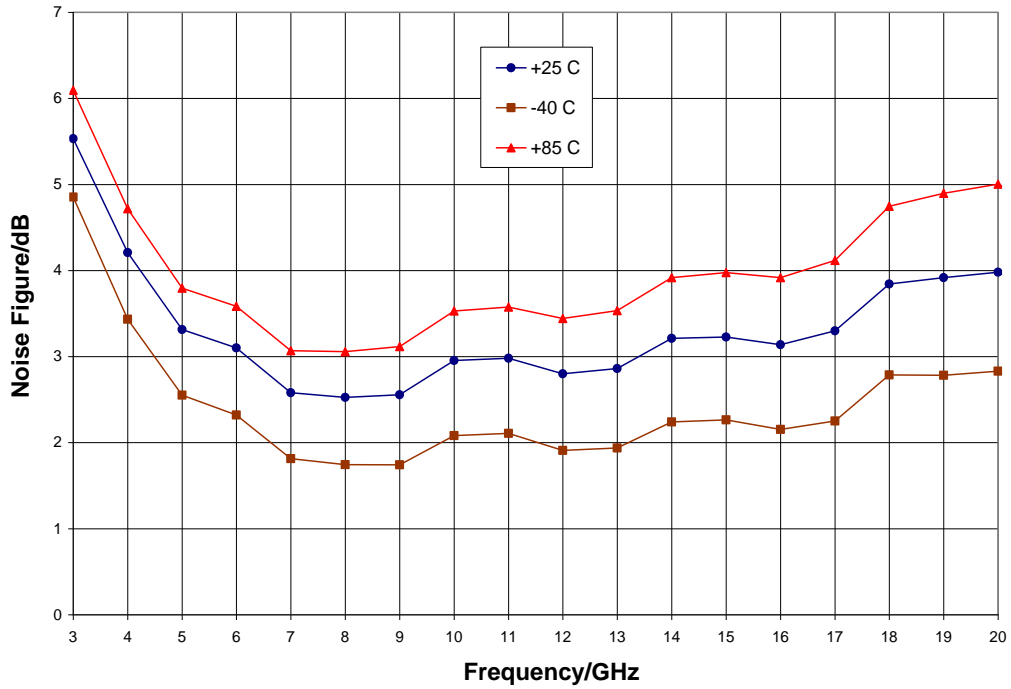

Noise Figure vs.  $V_{dd}$ ,  $T_A = 25^\circ\text{ C}$

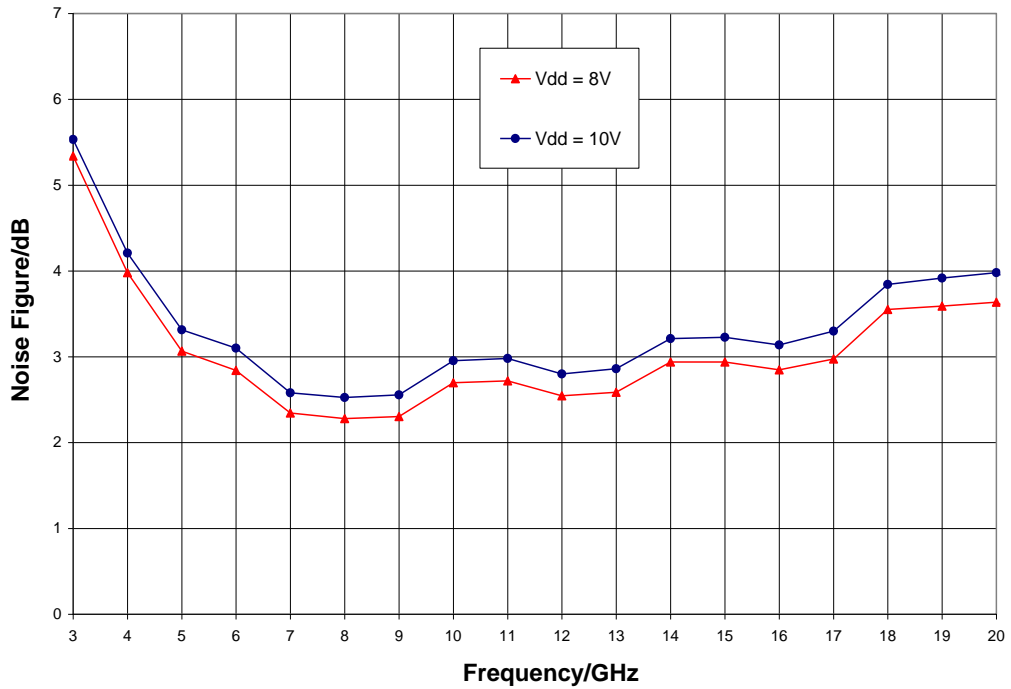

Typical Performance

Output Power,  $V_{dd} = 10\text{ V}$ ,  $V_{gg} = -0.55\text{ V}$ ,  $T_A = 25^\circ\text{ C}$

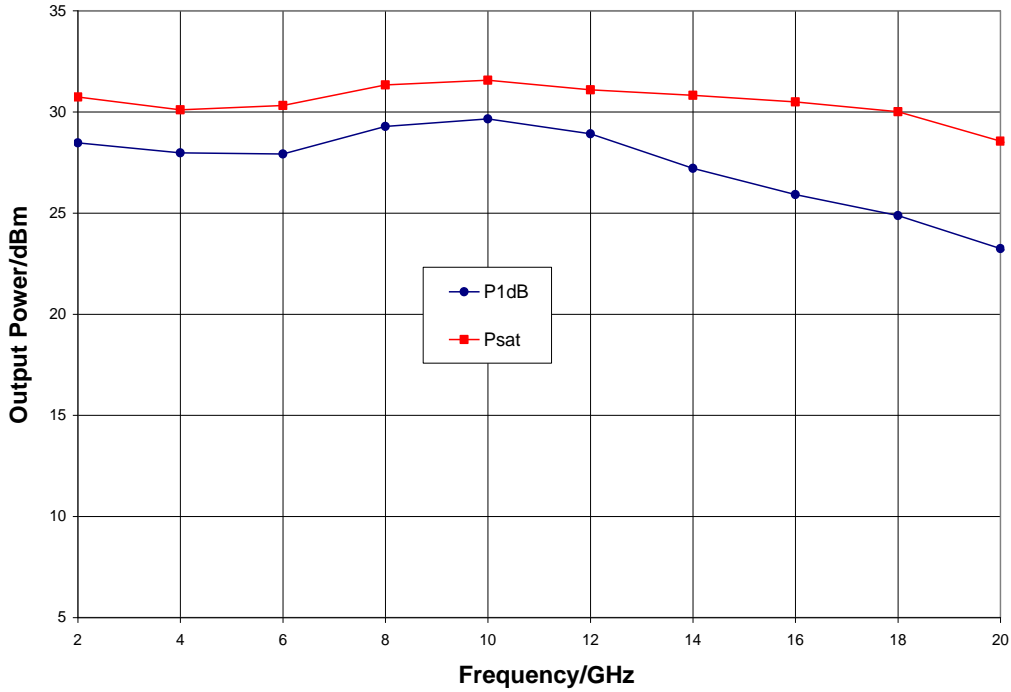

P1dB vs. Temperature,  $V_{dd} = 10\text{ V}$ ,  $V_{gg} = -0.55\text{ V}$

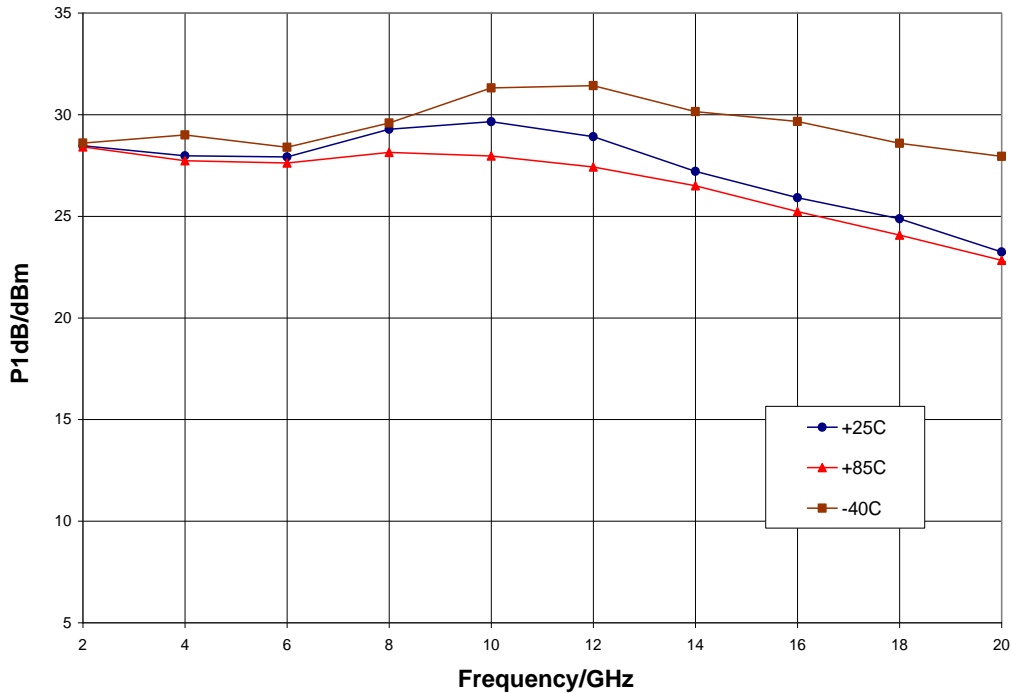

Typical Performance

P1dB vs.  $V_{dd}$ ,  $T_A = 25^\circ\text{C}$

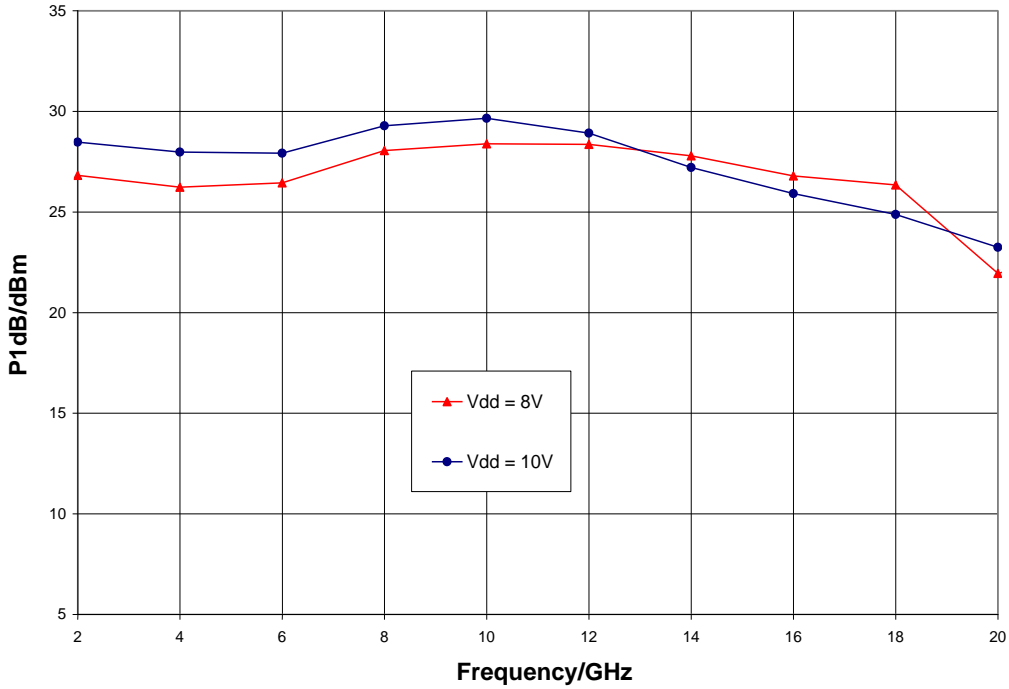

Output IP3 vs. Temperature,  $V_{dd} = 10\text{ V}$ ,  $V_{gg} = -0.55\text{ V}$

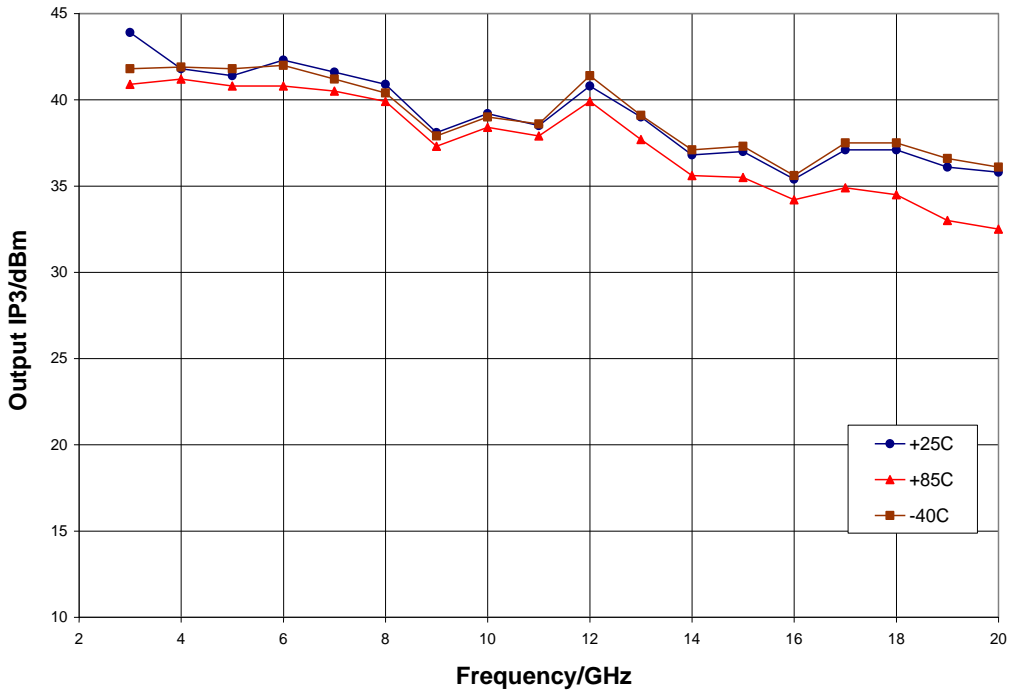

Typical Performance

Output IP2,  $V_{dd} = 10\text{ V}$ ,  $V_{gg} = -0.55\text{ V}$

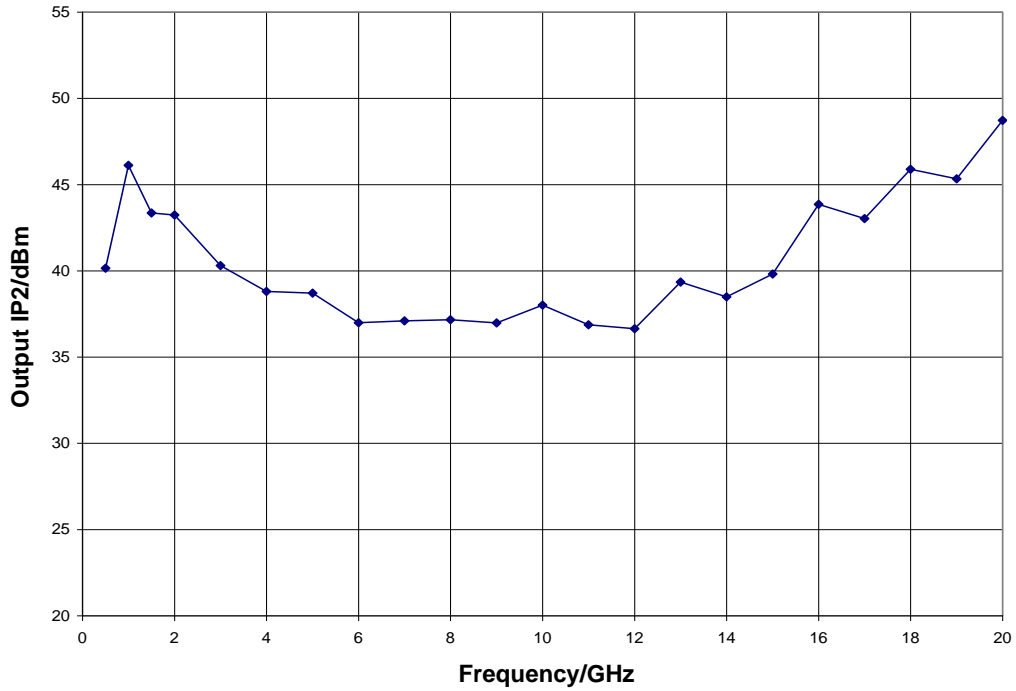

**Mechanical Information**

**Package Information and Dimensions**

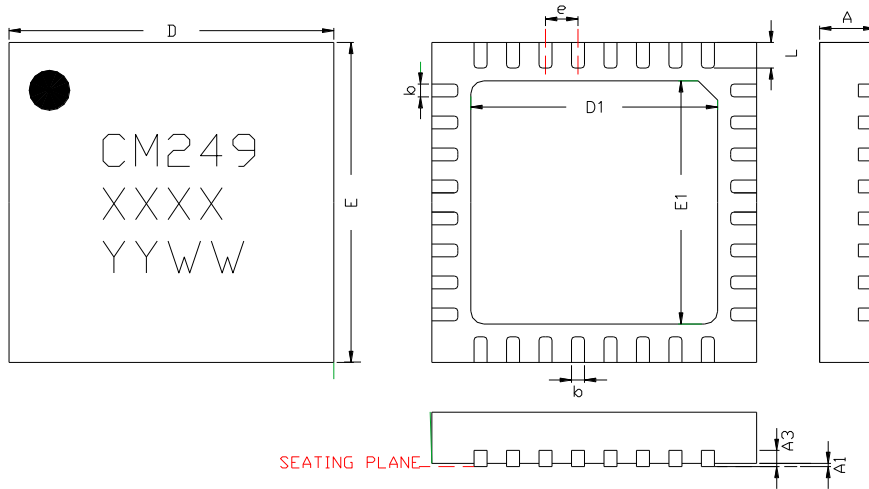

SYMBOLS	DIMENSIONS IN MILLIMETERS		
	MIN	NOM	MAX
A	0.80	0.90	1.00
A1	0	0.02	0.05
A3	---	0.25REF.	---
b	0.18	0.23	0.30
D	4.85	5.00	5.15
D1	---	3.8BSC	---
E	4.85	5.00	5.15
E1	---	3.8BSC	---
e	---	0.50BSC	---
L	0.30	0.40	0.50

**Notes:**

1. Dimensions are in millimeters
2. RoHS compliant mold compound
3. Lead frame material: Copper alloy
4. Lead finish: 100% matte Sn
5. Indicated dimension/tolerance applies to leads and exposed pad

**Recommended PCB Land Pattern**

Qorvo recommends that the user develop the land pattern that will provide the best design for proper solder reflow and device attach for their specific application. Please review Qorvo Application Note AN 105 for a recommended land pattern approach.

**Recommended Solder Reflow Profile**

Qorvo recommends screen printing with belt furnace reflow to ensure proper solder reflow and device attach. Please review Qorvo Application Note AN 102 for a recommended solder reflow profile.

## Pin Description

### Pin Diagram

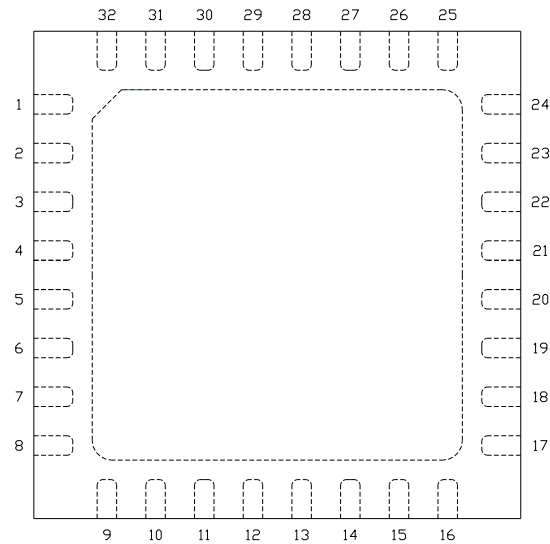

### Functional Description

Pin	Function	Description	Schematic
1, 3, 7 - 12, 14, 17 - 19, 23 - 28, 31, 32	N/C	No connection required These pins may be connected to RF / DC ground	
2	V <sub>gg2</sub>	Optional supply voltage for gain control Decoupling and bypass caps required Pin must be left open if unused	
4, 6, 20, 22 and die paddle	Ground	Connect to RF / DC ground	
5	RF in	50 ohm matched input	
15, 16	ACG4, 3	Low frequency termination Attach bypass capacitor per application circuit	
13	V <sub>gg</sub>	Power supply voltage Decoupling and bypass caps required	
21	RF out & V <sub>dd</sub>	Power supply voltage and 50 ohm matched output	
29, 30	ACG2, 1	Low frequency termination Attach bypass capacitor per application circuit	

## Applications Information

### Evaluation Board

The circuit board shown has been developed for optimized assembly at Qorvo. A sufficient number of via holes should be used to connect the top and bottom ground planes. As surface mount processes vary, careful process development is recommended.

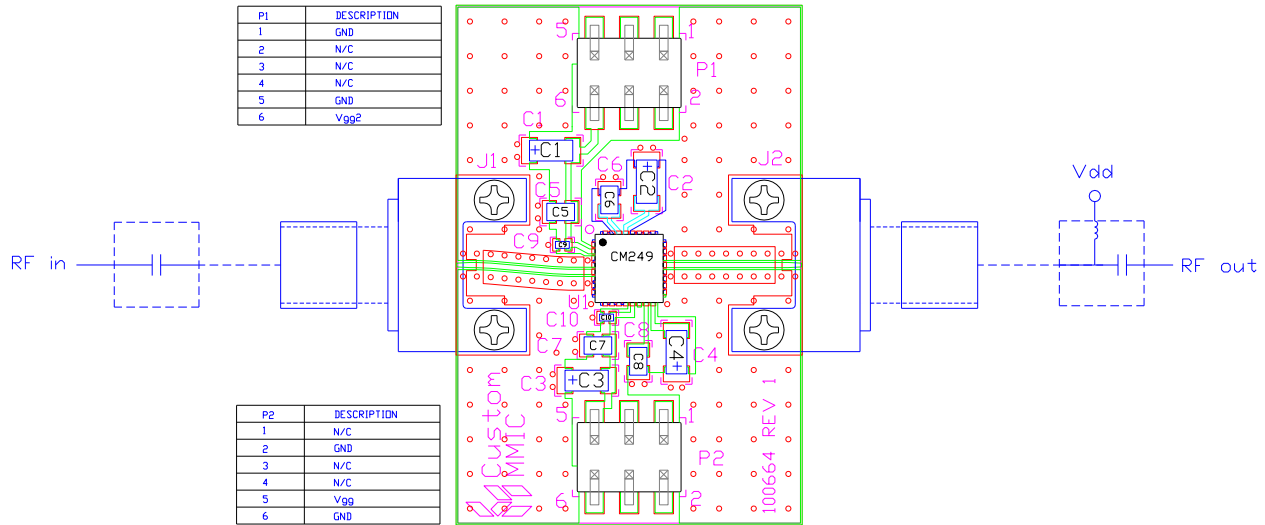

### Bill of Material

Designator	Value	Description
J1, J2		SMA End Launch Connector
P1, P2		6 Pin DC Header
C1 - C4	0.33 $\mu$ F	Capacitor, Tantalum
C5 - C8	1000 pF	Capacitor, 0603
C9, C10	100 pF	Capacitor, 0402
U1		CMD249P5 Driver Amplifier
PCB		100664 Evaluation PCB

**GaAs MMIC devices are susceptible to damage from Electrostatic Discharge. Proper precautions should be observed during handling, assembly and test.**

## Applications Information

### Application Circuit

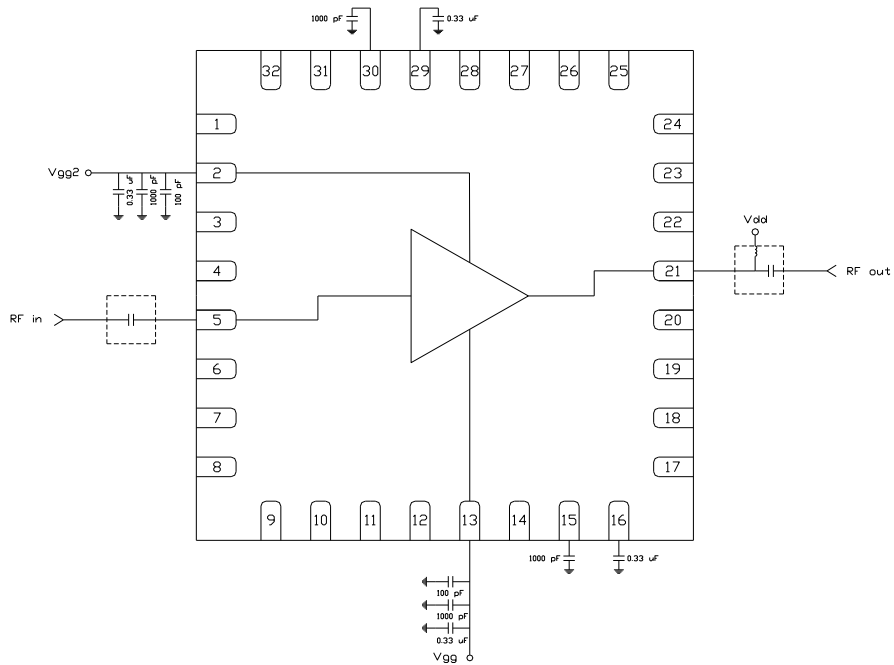

Note: Drain voltage ( $V_{dd}$ ) must be applied through a broadband bias tee or external bias network. External DC block is required on RF input.

### Biasing and Operation

The CMD249P5 is biased with a positive drain supply and a negative gate supply. Performance is optimized when the drain voltage is set to +10 V. The nominal gate voltage is -0.55 V.

Turn ON procedure:

1. Apply gate voltage  $V_{gg}$  and set to -2 V
2. Apply drain voltage  $V_{dd}$  and set to +10 V
3. Increase  $V_{gg}$  (less negative) to achieve a drain current of 400 mA

Turn OFF procedure:

1. Turn off drain voltage  $V_{dd}$
2. Turn off gate voltage  $V_{gg}$

RF power can be applied at any time.

## Handling Precautions

Parameter	Rating	Standard
ESD – Human Body Model (HBM)	Class 1A	ESDA / JEDEC JS-001-2012
MSL – Moisture Sensitivity Level	Level 1	JEDEC standard IPC/JEDEC J-STD-020



Caution!  
ESD-Sensitive Device

## RoHS Compliance

This part is compliant with 2011/65/EU RoHS directive (Restrictions on the Use of Certain Hazardous Substances in Electrical and Electronic Equipment) as amended by Directive 2015/863/EU.

This product also has the following attributes:

- Lead Free
- Antimony Free
- TBBP-A (C<sub>15</sub>H<sub>12</sub>Br<sub>4</sub>O<sub>2</sub>) Free
- SVHC Free
- Halogen Free
- PFOS Free

## Contact Information

For the latest specifications, additional product information, worldwide sales and distribution locations:

**Web:** [www.qorvo.com](http://www.qorvo.com)

**Tel:** 1-844-890-8163

**Email:** [customer.support@qorvo.com](mailto:customer.support@qorvo.com)

## Important Notice

---

The information contained in this Data Sheet and any associated documents (“Data Sheet Information”) is believed to be reliable; however, Qorvo makes no warranties regarding the Data Sheet Information and assumes no responsibility or liability whatsoever for the use of said information. All Data Sheet Information is subject to change without notice. Customers should obtain and verify the latest relevant Data Sheet Information before placing orders for Qorvo® products. Data Sheet Information or the use thereof does not grant, explicitly, implicitly or otherwise any rights or licenses to any third party with respect to patents or any other intellectual property whether with regard to such Data Sheet Information itself or anything described by such information.

DATA SHEET INFORMATION DOES NOT CONSTITUTE A WARRANTY WITH RESPECT TO THE PRODUCTS DESCRIBED HEREIN, AND QORVO HEREBY DISCLAIMS ANY AND ALL WARRANTIES WITH RESPECT TO SUCH PRODUCTS WHETHER EXPRESS OR IMPLIED BY LAW, COURSE OF DEALING, COURSE OF PERFORMANCE, USAGE OF TRADE OR OTHERWISE, INCLUDING THE IMPLIED WARRANTIES OF MERCHANTABILITY AND FITNESS FOR A PARTICULAR PURPOSE. Without limiting the generality of the foregoing, Qorvo® products are not warranted or authorized for use as critical components in medical, life-saving, or life-sustaining applications, or other applications where a failure would reasonably be expected to cause severe personal injury or death. Applications described in the Data Sheet Information are for illustrative purposes only. Customers are responsible for validating that a particular product described in the Data Sheet Information is suitable for use in a particular application.

© 2022 Qorvo US, Inc. All rights reserved. This document is subject to copyright laws in various jurisdictions worldwide and may not be reproduced or distributed, in whole or in part, without the express written consent of Qorvo US, Inc. | QORVO® is a registered trademark of Qorvo US, Inc.

## Looking for pricing, stock, or lifecycle information?

Click below to explore more details on WIN SOURCE:

 [View CMD249P5 on WIN SOURCE](#)

 [Qorvo US Inc. Information](#)

## Optimize Your Supply Chain with WIN SOURCE Solutions

-  Global Sourcing Solution
-  Obsolete Management
-  Cost Control Management
-  Shortage Management
-  Alternative Solution
-  Excess Inventory Management