

FEATURES

- ▶ Broadband TxVGA interfacing RF-DAC to beamformer and PA
- ▶ Operating frequency range: 0.38 GHz to 15 GHz, two product variants
 - ▶ ADL6331-A: 0.38 GHz to 8.0 GHz
 - ▶ ADL6331-B: 1.0 GHz to 15.0 GHz
- ▶ Optimizes common-mode rejection of RF-DAC, even-order harmonics, and intermodulation
- ▶ 50 Ω differential inputs and 50 Ω single-ended output
- ▶ Integrated broadband RF output balun
- ▶ 70 dB of gain control range in 1.0 dB step
- ▶ RF DSA range: 24.0 dB with 1.0 dB step
- ▶ Amplifier bypass loss of 12 dB each
- ▶ Asynchronous toggle between multiple predefined attenuation values and bypass amplifier stages
- ▶ Power gain at 4 GHz: 15.5 dB (ADL6331-A), 15.8 dB (ADL6331-B)
- ▶ Noise figure at 4 GHz: 7.5 dB (ADL6331-A), 8.1 dB (ADL6331-B)
- ▶ OIP3 at 4 GHz: 32.8 dBm (ADL6331-A), 31.8 dBm (ADL6331-B)
- ▶ OIP2 at 4 GHz: 59.7 dBm (ADL6331-A), 56.2 dBm (ADL6331-B)
- ▶ OP1dB at 4 GHz: 12.2 dBm (ADL6331-A), 12.3 dBm (ADL6331-B)
- ▶ Fully programmable through a 3- or 4-wire SPI
- ▶ Single 3.3 V supply
- ▶ 24-terminal, 4.0 mm × 4.0 mm land grid array (LGA)

APPLICATIONS

- ▶ Aerospace and defense
- ▶ Instrumentation and test equipment
- ▶ Communication systems

GENERAL DESCRIPTION

The ADL6331 transmit variable gain amplifier (TxVGA) provides an interface from RF digital-to-analog converters (RF DACs) to a singled-ended power amplifier (PA) signal chain. Each ADL6331 IC is composed of a balun, two differential RF amplifiers with bypass attenuators, and a digital step attenuator (DSA) to provide suitable transmitter performance in a [24-terminal, 4.0 mm x 4.0 mm LGA package](#).

Serial-port interface (SPI) control is available to configure RF signal paths or to optimize supply current vs. performance.

An integrated RF balun is used to provide a single-ended output over 0.38 GHz to 8.0 GHz (ADL6331-A) or 1.0 GHz to 15.0 GHz (ADL6331-B) with good impedance match.

Table 1. ADL6331 Frequency Ranges

ADL6331 Variant	Frequency Range (GHz)
A	0.38 to 8.0
B	1.0 to 15.0

FUNCTIONAL BLOCK DIAGRAM

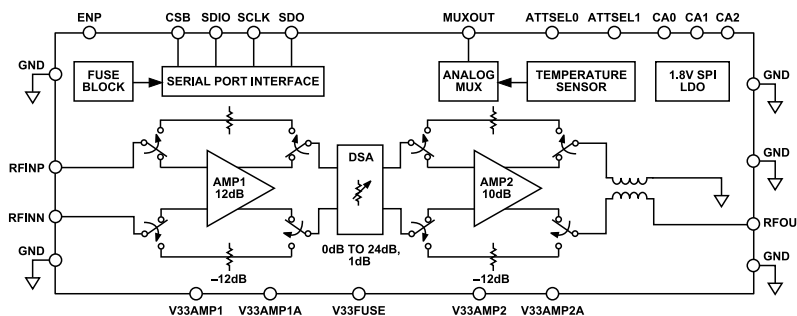

Figure 1. Functional Block Diagram

TABLE OF CONTENTS

Features.....	1	AMP1 and AMP2 Trimming and Tuning.....	29
Applications.....	1	RF Path Preconfiguration.....	30
General Description.....	1	Auxiliary Mux Out/Temperature Sensor.....	31
Functional Block Diagram.....	1	NVM (Fuse) Space (Reference Only).....	31
Specifications.....	4	Serial Port Interface (SPI).....	33
Digital Logic Timing.....	8	Configuring Multiple Chips to Share the SPI	
Absolute Maximum Ratings.....	10	Bus.....	33
Thermal Resistance.....	10	Initialization Sequence.....	34
ESD Caution.....	10	Basic Connections.....	35
Pin Configuration and Function Descriptions.....	11	Applications Information.....	36
Typical Performance Characteristics.....	12	Current Consumption Optimization.....	36
ADL6331-A.....	13	AC Coupling.....	36
ADL6331-B.....	20	Register Summary.....	37
Theory of Operation.....	27	Register Details.....	39
RF Input and Output.....	27	Outline Dimensions.....	54
Programmability Guide.....	28	Ordering Guide.....	54
Function and Signal Path Enable.....	28	Evaluation Boards.....	54

REVISION HISTORY

8/2024—Rev. A to Rev. B

Change to Data Sheet Title.....	1
Changes to Features Section.....	1
Changes to General Description Section.....	1
Changes to Table 2.....	4
Changes to Figure 53 to Figure 58.....	20
Changes to Figure 62 and Figure 63.....	21
Changes to Figure 65 to Figure 67, Figure 69, and Figure 70.....	22
Changes to Figure 71 to Figure 74 and Figure 76.....	23
Changes to Figure 77 to Figure 80 and Figure 82.....	24
Changes to Figure 83.....	25
Changes to Figure 91 and Figure 92.....	26
Change to AMP1 and AMP2 Trimming and Tuning Section.....	29
Change to Current Consumption Optimization Section.....	36
Change to Evaluation Boards.....	54

5/2024—Rev. 0 to Rev. A

Changes to Features Section.....	1
Changes to Table 2.....	4
Changes to Figure 35 Caption to Figure 38 Caption.....	16
Added ADL6331-B Section and Figure 53 to Figure 92; Renumbered Sequentially.....	20
Changes to AMP1 and AMP2 Trimming and Tuning Section.....	29
Changes to Current Consumption Optimization Section.....	36
Changes to Figure 96 Caption.....	36
Added Figure 97.....	36
Changes to Figure 98 Caption.....	36
Added Figure 99.....	36
Changed Common-Mode Voltage Section to AC Coupling Section.....	36
Changes to Ordering Guide.....	54

TABLE OF CONTENTS

Changes to Evaluation Boards..... 54

2/2024—Revision 0: Initial Version

SPECIFICATIONS

V33AMP1 voltage (V_{33AMP1}) = V33AMP1A voltage ($V_{33AMP1A}$) = V33AMP2 voltage (V_{33AMP2}) = V33AMP2A voltage ($V_{33AMP2A}$) = V33FUSE voltage (V_{33FUSE}) = 3.3V. $T_A = 25^\circ\text{C}$, fixed gain mode, DSA attenuation = 0 dB, source resistance (R_S) = 50 Ω differential, and load resistance (R_L) = 50 Ω single-ended, unless otherwise noted.

Table 2. Specifications

Parameter	Test Conditions/Comments	Min	Typ	Max	Units
FREQUENCY RANGE (ADL6331-A)		0.38		8.0	GHz
Power Gain					
Full Fixed Gain Mode ¹	0.38 GHz		12.7		dB
	1.0 GHz		15.7		dB
	2.0 GHz		15.9		dB
	4.0 GHz		15.5		dB
	8.0 GHz		14.4		dB
AMP1 Bypass Attenuation Mode ² : AMP2 = Fixed Gain Mode	0.38 GHz		-14.6		dB
	1.0 GHz		-9.5		dB
	2.0 GHz		-9.2		dB
	4.0 GHz		-9.6		dB
	8.0 GHz		-11.5		dB
AMP2 Bypass Attenuation Mode ² : AMP1 = Fixed Gain Mode	0.38 GHz		-12.0		dB
	1.0 GHz		-7.1		dB
	2.0 GHz		-7.0		dB
	4.0 GHz		-7.1		dB
	8.0 GHz		-7.8		dB
Full Bypass Attenuation Mode ²	0.38 GHz		-36.3		dB
	1.0 GHz		-31.9		dB
	2.0 GHz		-31.7		dB
	4.0 GHz		-32.8		dB
	8.0 GHz		-33.4		dB
FREQUENCY RANGE (ADL6331-B)		1.0		15.0	GHz
Power Gain					
Full Fixed Gain Mode ¹	1.0 GHz		15.2		dB
	2.0 GHz		16.0		dB
	4.0 GHz		15.8		dB
	8.0 GHz		14.6		dB
	12.0 GHz		14.8		dB
	15.0 GHz		14.7		dB
AMP1 Bypass Attenuation Mode ² : AMP2 = Fixed Gain Mode	1.0 GHz		-10.0		dB
	2.0 GHz		-9.1		dB
	4.0 GHz		-9.4		dB
	8.0 GHz		-11.6		dB
	12.0 GHz		-13.5		dB
	15.0 GHz		-17.5		dB
AMP2 Bypass Attenuation Mode ² : AMP1 = Fixed Gain Mode	1.0 GHz		-7.5		dB
	2.0 GHz		-6.6		dB
	4.0 GHz		-6.7		dB
	8.0 GHz		-7.3		dB
	12.0 GHz		-7.5		dB
	15.0 GHz		-9.0		dB
Full Bypass Attenuation Mode ²	1.0 GHz		-31.7		dB
	2.0 GHz		-31.3		dB
	4.0 GHz		-32.1		dB

SPECIFICATIONS

Table 2. Specifications (Continued)

Parameter	Test Conditions/Comments	Min	Typ	Max	Units
	8.0 GHz		-33.1		dB
	12.0 GHz		-35.8		dB
	15.0 GHz		-40.0		dB
NOISE/HARMONIC PERFORMANCE (ADL6331-A)					
Input Signal Frequency 0.4 GHz					
Full Fixed Gain Mode ¹					
Output Second-Order Intercept (OIP2L/OIP2H ³)	Pin = -22 dBm/tone		51.8/65.8		dBm
Output Third-Order Intercept (OIP3)	Pin = -22 dBm/tone		29.9		dBm
Output 1dB Compression Point (OP1dB)			10.5		dBm
Noise Figure (NF)			7.2		dB
AMP1 Bypass Attenuation Mode ²					
Input Second-Order Intercept (IIP2L/IIP2H ⁴)	Pin = +2 dBm/tone		50.1/42.8		dBm
Input Third-Order Intercept (IIP3)	Pin = +2 dBm/tone		28.9		dBm
Input 1dB Compression Point (IP1dB) ⁵			>10		dBm
NF			27.6		dB
Input Signal Frequency 1.0 GHz					
Full Fixed Gain Mode ¹					
OIP2L/OIP2H ³	Pin = -22 dBm/tone		62.9/63.2		dBm
OIP3	Pin = -22 dBm/tone		32.7		dBm
OP1dB			12.7		dBm
NF			7.3		dB
AMP1 Bypass Attenuation Mode ²					
IIP2L/IIP2H ⁴	Pin = +2 dBm/tone		67.5/60.0		dBm
IIP3	Pin = +2 dBm/tone		28.8		dBm
IP1dB ⁵			>10		dBm
NF			25.2		dB
Input Signal Frequency 2.0 GHz					
Full Fixed Gain Mode ¹					
OIP2L/OIP2H ³	Pin = -22 dBm/tone		63.0/59.8		dBm
OIP3	Pin = -22 dBm/tone		32.8		dBm
OP1dB			13.0		dBm
NF			7.5		dB
AMP1 Bypass Attenuation Mode ²					
IIP2L/IIP2H ⁴	Pin = +2 dBm/tone		66.1/61.7		dBm
IIP3	Pin = +2 dBm/tone		28.8		dBm
IP1dB ⁵			>10		dBm
NF			25.5		dB
Input Signal Frequency 4.0 GHz					
Full Fixed Gain Mode ¹					
OIP2L/OIP2H ³	Pin = -22 dBm/tone		59.7/N/A ⁶		dBm
OIP3	Pin = -22 dBm/tone		32.8		dBm
OP1dB			12.2		dBm
NF			7.5		dB
AMP1 Bypass Attenuation Mode ²					
IIP2L/IIP2H ⁴	Pin = +2 dBm/tone		64.0/N/A ⁶		dBm
IIP3	Pin = +2 dBm/tone		28.0		dBm
IP1dB ⁵			>10		dBm
NF			25.4		dB
Input Signal Frequency 8.0 GHz					

SPECIFICATIONS

Table 2. Specifications (Continued)

Parameter	Test Conditions/Comments	Min	Typ	Max	Units
Full Fixed Gain Mode ¹					
OIP2L/OIP2H ³	Pin = -22 dBm/tone		55.5/N/A ⁶		dBm
OIP3	Pin = -22 dBm/tone		37.8		dBm
OP1dB			11.5		dBm
NF			6.8		dB
AMP1 Bypass Attenuation Mode ²					
IIP2L/IIP2H ⁴	Pin = +2 dBm/tone		64.3/N/A ⁶		dBm
IIP3	Pin = +2 dBm/tone		27.1		dBm
IP1dB ⁵			>10		dBm
NF			25.3		dB
NOISE/HARMONIC PERFORMANCE (ADL6331-B)					
Input Signal Frequency 1.0 GHz					
Full Fixed Gain Mode ¹					
OIP2L/OIP2H	Pin = -22 dBm/tone		55.4/62.7		dBm
OIP3	Pin = -22 dBm/tone		30.1		dBm
OP1dB			12.3		dBm
NF			7.6		dB
AMP1 Bypass Attenuation Mode ²					
IIP2L/IIP2H	Pin = +2 dBm/tone		61.7/54.6		dBm
IIP3	Pin = +2 dBm/tone		28.1		dBm
IP1dB ⁵			>10		dBm
NF			25.7		dB
Input Signal Frequency 2.0 GHz					
Full Fixed Gain Mode ¹					
OIP2L/OIP2H	Pin = -22 dBm/tone		58.2/56.8		dBm
OIP3	Pin = -22 dBm/tone		31.1		dBm
OP1dB			12.9		dBm
NF			7.9		dB
AMP1 Bypass Attenuation Mode ²					
IIP2L/IIP2H	Pin = +2 dBm/tone		61.2/58.7		dBm
IIP3	Pin = +2 dBm/tone		28.2		dBm
IP1dB ⁵			>10		dBm
NF			25.9		dB
Input Signal Frequency 4.0 GHz					
Full Fixed Gain Mode ¹					
OIP2L/OIP2H	Pin = -22 dBm/tone		56.2/51.6		dBm
OIP3	Pin = -22 dBm/tone		31.8		dBm
OP1dB			12.3		dBm
NF			8.1		dB
AMP1 Bypass Attenuation Mode ²					
IIP2L/IIP2H	Pin = +2 dBm/tone		60.2/69.3		dBm
IIP3	Pin = +2 dBm/tone		27.7		dBm
IP1dB ⁵			>10		dBm
NF			25.9		dB
Input Signal Frequency 8.0 GHz					
Full Fixed Gain Mode ¹					
OIP2L/OIP2H	Pin = -22 dBm		51.7/N/A ⁷		dBm
OIP3	Pin = -22 dBm		31.2		dBm
OP1dB			11.2		dBm

SPECIFICATIONS

Table 2. Specifications (Continued)

Parameter	Test Conditions/Comments	Min	Typ	Max	Units
NF			7.4		dB
AMP1 Bypass Attenuation Mode ²					
IIP2L/IIP2H	Pin = +2 dBm/tone		62.6/N/A ⁷		dBm
IIP3	Pin = +2 dBm/tone		27.0		dBm
IP1dB ⁵			>10		dBm
NF			26.5		dB
Input Signal Frequency 12.0 GHz					
Full Fixed Gain Mode ¹					
OIP2L/OIP2H	Pin = -22 dBm/tone		48.7/N/A ⁷		dBm
OIP3	Pin = -22 dBm/tone		27.8		dBm
OP1dB			10.3		dBm
NF			7.1		dB
AMP1 Bypass Mode ²					
IIP2L/IIP2H	Pin = +2 dBm/tone		63.4/N/A ⁷		dBm
IIP3	Pin = +2 dBm/tone		26.2		dBm
IP1dB ⁵			>10		dBm
NF			27.4		dB
INPUT/OUTPUT CHARACTERISTICS					
Input Impedance	Differential		50		Ω
Input Return Loss	Differential		12.0		dB
Output Impedance	Single-ended		50		Ω
Output Return Loss	In band, includes output balun single-ended		12.0		dB
GAIN FLATNESS					
1.0 to 12 GHz	In a 1 GHz bandwidth		0.5		dB
1.5 to 12 GHz	In a 3 GHz bandwidth		1.1		dB
DSA ATTENUATION					
Range			24.0		dB
Step	Through SPI		1.0		dB
Differential Nonlinearity (DNL)		0	0.16	0.5	dB
SWITCHING TIME					
	1.0 dB step via ATTSEL pins		200		ns
DIGITAL LOGIC					
Input Voltage	SCLK, SDO, SDIO, CSB, ENP, CA0, CA1, CA2, ATTSEL0, ATTSEL1				
High (V _{IH})		1.07			V
Low (V _{IL})				0.68	V
Input Current					
High (I _{IH})				-100	μA
Low (I _{IL})				100	μA
Output Voltage	SDO, SDIO (3-wire SPI mode)				
At 1.8 V					
High (V _{OH})	Output high current (I _{OH}) = -100 μA or -1 mA static load	1.5			V
Low (V _{OL})	Output low current (I _{OL}) = 100 μA or 1 mA static load			0.2	V
At 3.3 V					
V _{OH}	I _{OH} = -100 μA or -1 mA static load	2.7			V
V _{OL}	I _{OL} = 100 μA or 1 mA static load			0.2	V
POWER SUPPLY					
Voltage					V
V33AMP1A		3.135	3.3	3.465	V

SPECIFICATIONS

Table 2. Specifications (Continued)

Parameter	Test Conditions/Comments	Min	Typ	Max	Units
V33AMP1		3.135	3.3	3.465	V
V33AMP2A		3.135	3.3	3.465	V
V33AMP2		3.135	3.3	3.465	V
V33FUSE		3.135	3.3	3.465	V
Current					
Full Fixed Gain Mode ¹	3.3 V supply				
V33AMP1A			80		mA
V33AMP1			160		mA
V33AMP2A			80		mA
V33AMP2			160		mA
V33FUSE			35		mA
AMP1 Bypass Attenuation Mode ²	3.3 V supply				
V33AMP1A			2		mA
V33AMP1			0.1		mA
V33AMP2A			80		mA
V33AMP2			160		mA
V33FUSE			22		mA
AMP2 Bypass Attenuation Mode ²	3.3 V supply				
V33AMP1A			80		mA
V33AMP1			160		mA
V33AMP2A			0.1		mA
V33AMP2			0.1		mA
V33FUSE			22		mA
AMP1 and AMP2 Bypass Attenuation Mode ²	3.3 V supply				
V33AMP1A			2		mA
V33AMP1			0.1		mA
V33AMP2A			0.1		mA
V33AMP2			0.1		mA
V33FUSE			12		mA
Power-Down Mode	3.3 V supply		3		mA

¹ The full fixed gain mode is configured with the fixed gain configurations in AMP1 and AMP2, and DSA = 0 dB with the factory optimized parameters.

² The bypass attenuation mode is configured with the bypass settings in AMP1 or AMP2, and DSA = 0 dB with the factory optimized parameters. Bypassing an amplifier with the attenuation mode reduces the total current typically by 230 mA per amplifier.

³ OIP2L refers to the two tone difference frequency, OIP2H refers to the two tone summation frequency.

⁴ IIP2L refers to the two tone difference frequency, IIP2H refers to the two tone summation frequency.

⁵ Exceeds the absolute maximum rating.

⁶ Not applicable. For ADL6331-A, an input signal frequency ≥ 4 GHz makes OIP2H/IIP2H beyond the operating frequency range.

⁷ Not applicable. For ADL6331-B, an input signal frequency ≥ 7.5 GHz makes OIP2H/IIP2H beyond the operating frequency range.

DIGITAL LOGIC TIMING

Load capacitance (C_{LOAD}) = 25 pF.

Table 3. SPI Timing Specifications

Parameter	Description	Min	Typ	Max	Unit
f_{SCLK}	Maximum serial-clock rate			25	MHz
t_{PWH}	Minimum period that SCLK is in logic-high state	10			ns
t_{PWL}	Minimum period that SCLK is in logic-low state	10			ns

SPECIFICATIONS

Table 3. SPI Timing Specifications (Continued)

Parameter	Description	Min	Typ	Max	Unit
t_{DS}	Setup time between data and rising edge of SCLK	10			ns
t_{DH}	Hold time between data and rising edge of SCLK	5			ns
t_{DCS}	Setup time between falling edge of CSB and SCLK	10			ns
t_{DV}	Maximum time delay between falling edge of SCLK and output data valid for a read operation			10	ns

SPI Timing Diagrams

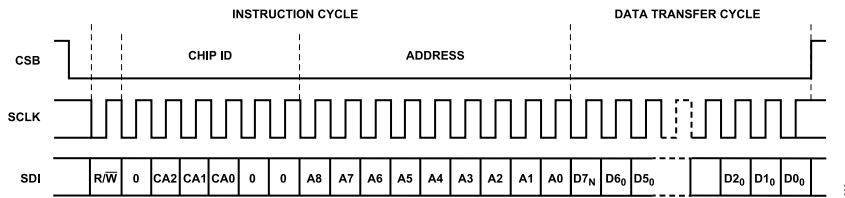

Figure 2. SPI Register Timing, MSB First

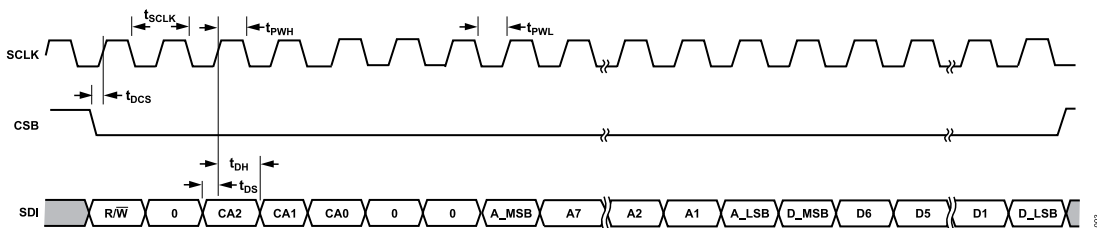

Figure 3. Timing Diagram for the SPI Register Write (3- and 4-Wire SPI Mode)

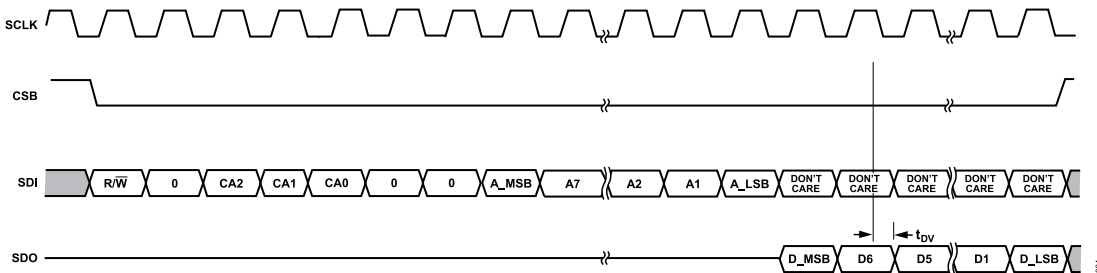

Figure 4. Timing Diagram for SPI Register Read (4-Wire SPI Mode)

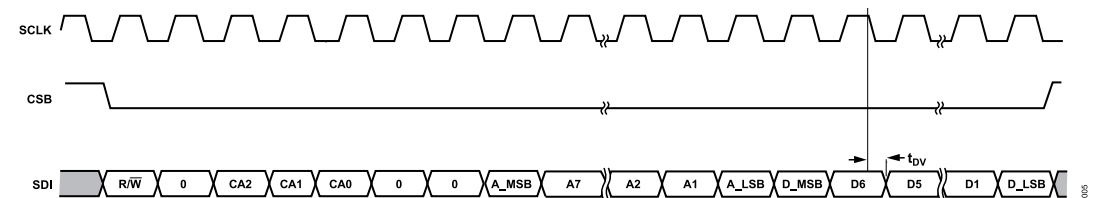

Figure 5. Timing Diagram for SPI Register Read (3-Wire SPI Mode, SDIO Pin Is Bidirectional Mode, Input (Write) and Output (Read))

ABSOLUTE MAXIMUM RATINGS

Table 4. Absolute Maximum Ratings

Parameter	Rating
V33AMP1, V33AMP1A, V33AMP2, V33AMP2A, V33FUSE	-0.3 V to +3.6 V
RFINN, RFINP	10 dBm
SCLK, SDO, SDIO, CSB, CA0, CA1, CA2, ENP, ATTSEL0, ATTSEL1	-0.3 V to +3.6 V
Maximum Junction Temperature	125°C
Operating Temperature Range (Measured at the exposed pad)	-40°C to +105°C
Storage Temperature Range	-65°C to +150°C

Stresses at or above those listed under Absolute Maximum Ratings may cause permanent damage to the product. This is a stress rating only; functional operation of the product at these or any other conditions above those indicated in the operational section of this specification is not implied. Operation beyond the maximum operating conditions for extended periods may affect product reliability.

THERMAL RESISTANCE

Thermal performance is directly linked to printed circuit board (PCB) design and operating environment. Careful attention to PCB thermal design is required.

θ_{JC} is the conduction thermal resistance from junction to case where the case temperature is measured at the bottom of the package.

The thermal resistance value specified in [Table 5](#) is simulated based on JEDEC specifications (unless specified otherwise) and must be used in compliance with JESD51-12.

Table 5. Thermal Resistance

Package Type	θ_{JC}	Unit
CC-24-17	9.6	°C/W

ESD CAUTION



ESD (electrostatic discharge) sensitive device. Charged devices and circuit boards can discharge without detection. Although this product features patented or proprietary protection circuitry, damage may occur on devices subjected to high energy ESD. Therefore, proper ESD precautions should be taken to avoid performance degradation or loss of functionality.

PIN CONFIGURATION AND FUNCTION DESCRIPTIONS

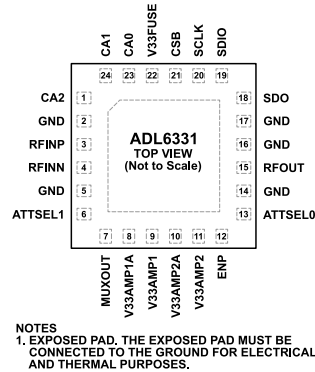

Figure 6. Pin Configuration

Table 6. Pin Function Descriptions

Pin No.	Mnemonic	Type	Description
1	CA2	Input	SPI Chip Address (MSB).
2, 5, 14, 16, 17	GND	Input and Output	Ground Reference.
3	RFINP	Input	Negative Side of Balanced Differential Inputs.
4	RFINN	Input	Positive Side of Balanced Differential Inputs.
6	ATTSEL1	Input	Preprogrammed Mode Selection (A, B, C, and D States).
7	MUXOUT	Output	Voltage Measurement Pin for Reading Chip Temperature. Leave as no connect when not in use.
8	V33AMP1A	Input	Analog 3.3 V Power-Supply Input for AMP1.
9	V33AMP1	Input	Analog 3.3 V Power-Supply Input for AMP1.
10	V33AMP2A	Input	Analog 3.3 V Power-Supply Input for AMP2.
11	V33AMP2	Input	Analog 3.3 V Power-Supply Input for AMP2.
12	ENP	Input	Power Up and Enable Input. Active High.
13	ATTSEL0	Input	Preprogrammed Mode Selection (A, B, C, and D States).
15	RFOUT	Output	Single-Ended RF Output.
18	SDO	Output	Serial-Port Data Output.
19	SDIO	Input and Output	Serial-Port Bidirectional Data Input and Output.
20	SCLK	Input	Serial-Port Clock Input.
21	CSB	Input	Serial-Port Enable Input. Active low.
22	V33FUSE	Input	Digital 3.3 V Power-Supply Input.
23	CA0	Input	SPI Chip Address (LSB).
24	CA1	Input	SPI Chip Address.
	EPAD	Input and Output	Exposed Pad. The exposed pad must be connected to ground for electrical and thermal purposes.

TYPICAL PERFORMANCE CHARACTERISTICS

$V_{33AMP1} = V_{33AMP1A} = V_{33AMP2} = V_{33AMP2A} = V_{33FUSE} = 3.3\text{ V}$, and $T_A = 25^\circ\text{C}$, unless otherwise noted.

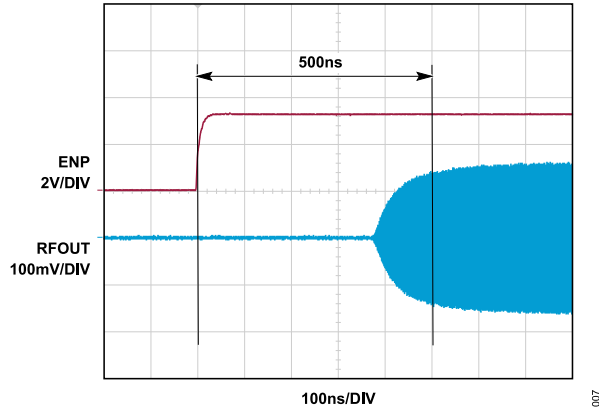

Figure 7. ENP Enable Response at Fixed Gain Mode, Minimum DSA Attenuation

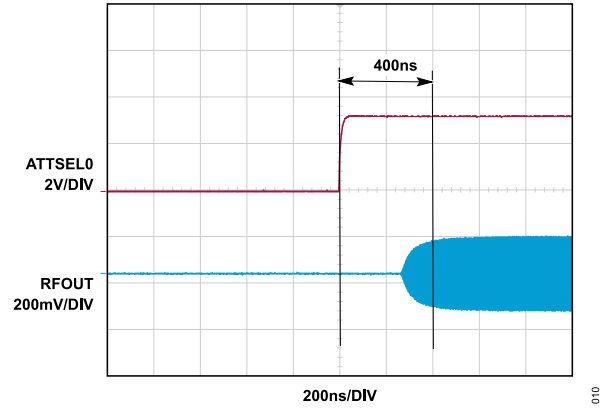

Figure 10. Gain Settling Time from Minimum Gain (AMP1/AMP2 Bypass and DSA = 24.0 dB) to Maximum Gain (No AMP Bypass and DSA = 0.0 dB)

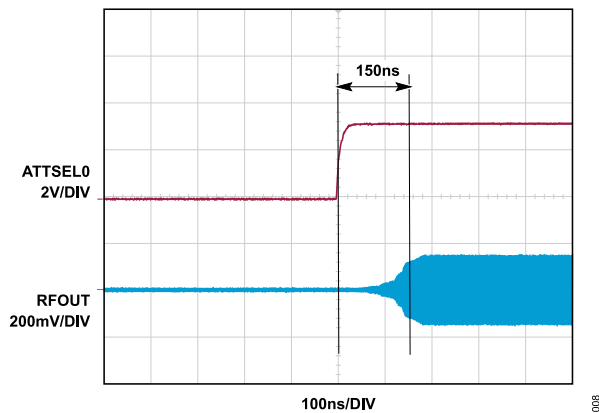

Figure 8. Gain Settling Time at Fixed Gain Mode, DSA from 24.0 dB to 0.0 dB

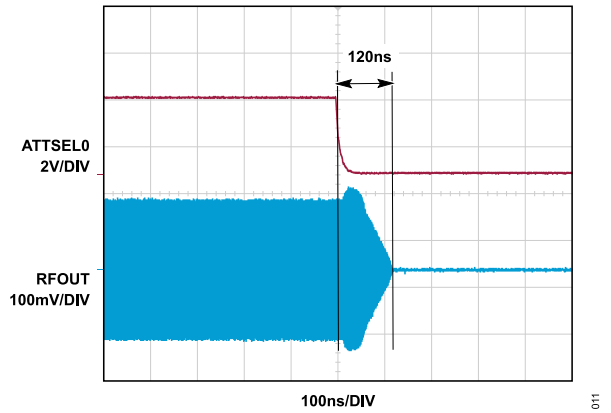

Figure 11. Gain Settling Time from Maximum Gain (NO AMP Bypass and DSA = 0.0 dB) to Minimum Gain (AMP1/AMP2 Bypass and DSA = 24.0 dB)

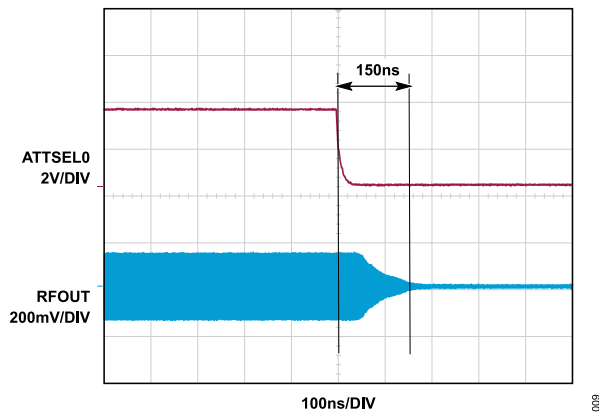

Figure 9. Gain Settling Time at Fixed Gain Mode, DSA from 0.0 dB to 24.0 dB

TYPICAL PERFORMANCE CHARACTERISTICS

ADL6331-A

$V_{33AMP1} = V_{33AMP1A} = V_{33AMP2} = V_{33AMP2A} = V_{33FUSE} = 3.3\text{ V}$, $T_A = 25^\circ\text{C}$, fixed gain mode, DSA attenuation = 0 dB, $R_S = 50\ \Omega$ differential, and $R_L = 50\ \Omega$ single-ended, unless otherwise noted.

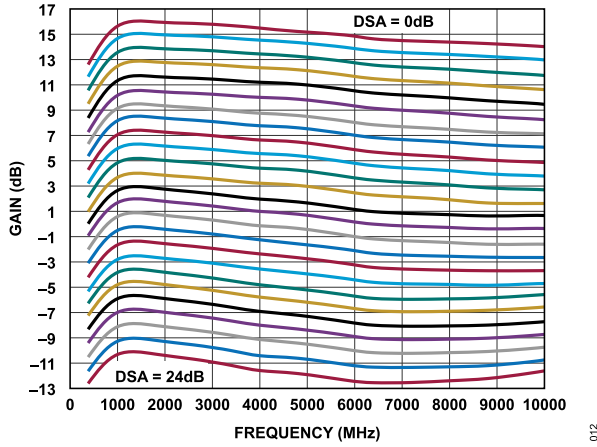

Figure 12. Gain vs. Frequency, 1.0 dB DSA Steps

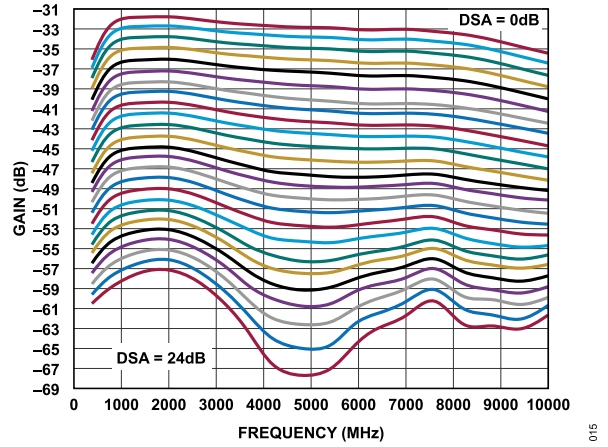

Figure 15. Gain vs. Frequency, 1.0 dB DSA Steps, AMP1 and AMP2 Bypass

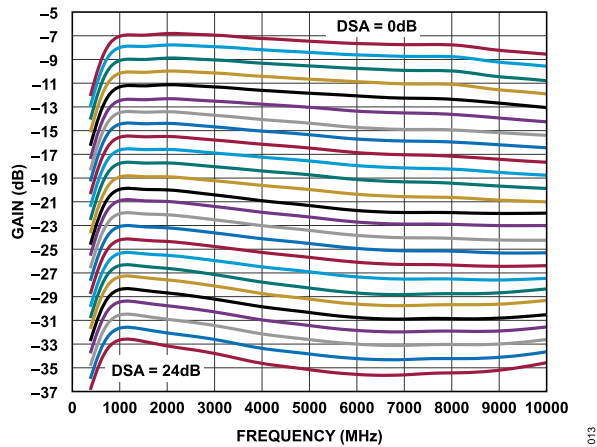

Figure 13. Gain vs. Frequency, 1.0 dB DSA Steps, AMP2 Bypass

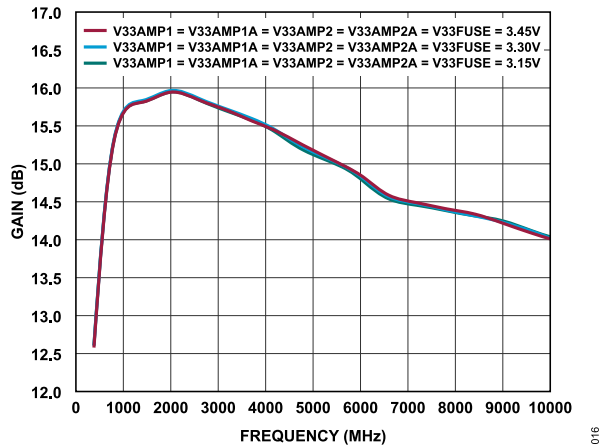

Figure 16. Gain vs. Frequency for Various Supplies

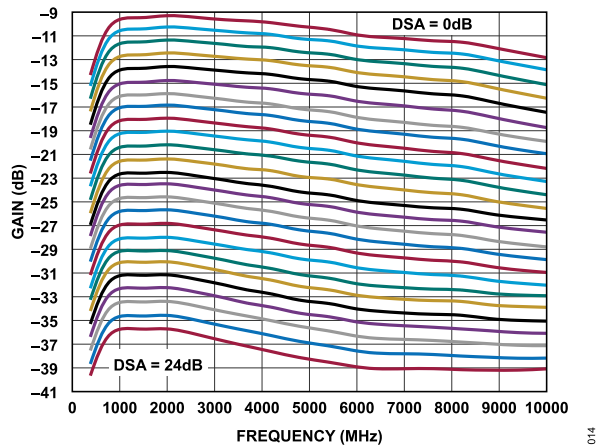

Figure 14. Gain vs. Frequency, 1.0 dB DSA Steps, AMP1 Bypass

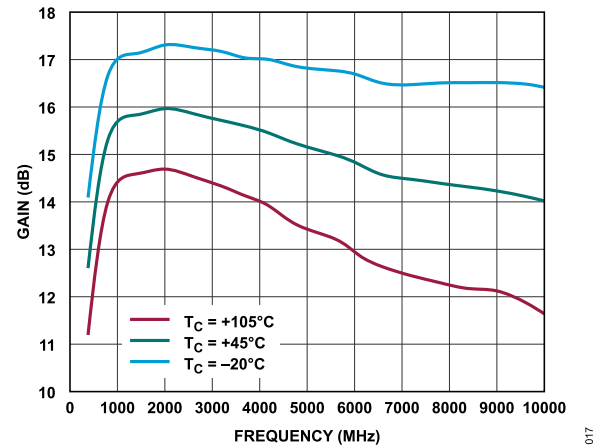

Figure 17. Gain vs. Frequency for Various Temperatures

TYPICAL PERFORMANCE CHARACTERISTICS

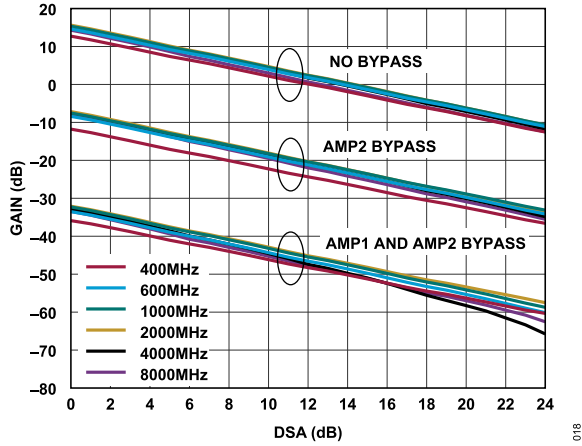

Figure 18. Gain vs. 1.0 dB DSA Steps for Various Frequencies, AMP2 Bypass

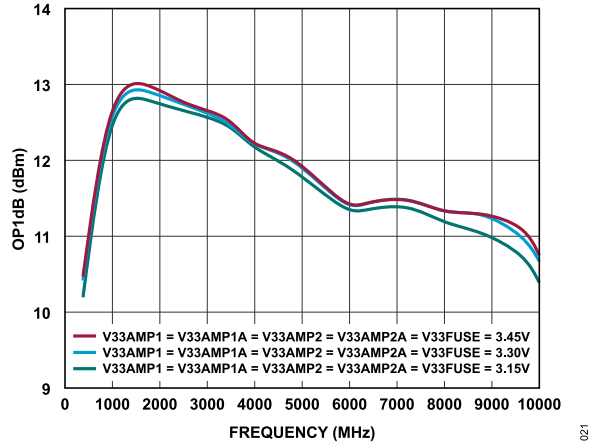

Figure 21. OP1dB vs. Frequency for Various Supplies

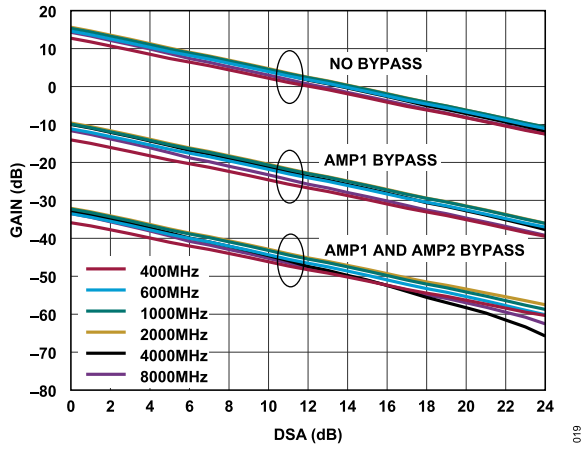

Figure 19. Gain vs. 1.0 dB DSA Steps for Various Frequencies, AMP1 Bypass

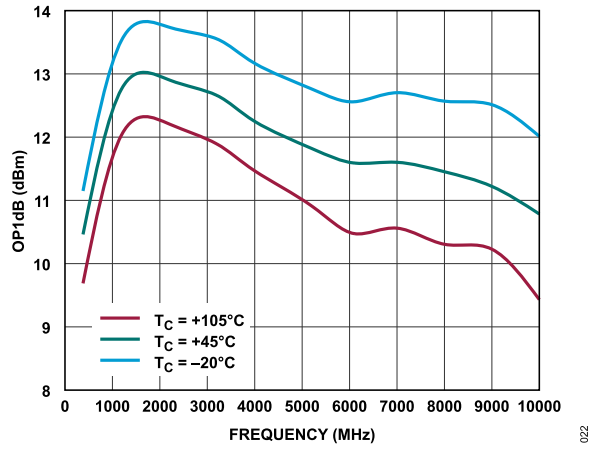

Figure 22. OP1dB vs. Frequency for Various Temperatures

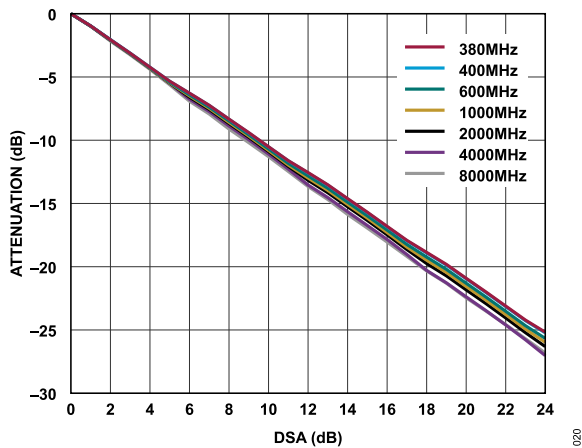

Figure 20. Attenuation vs. DSA for Various Frequencies

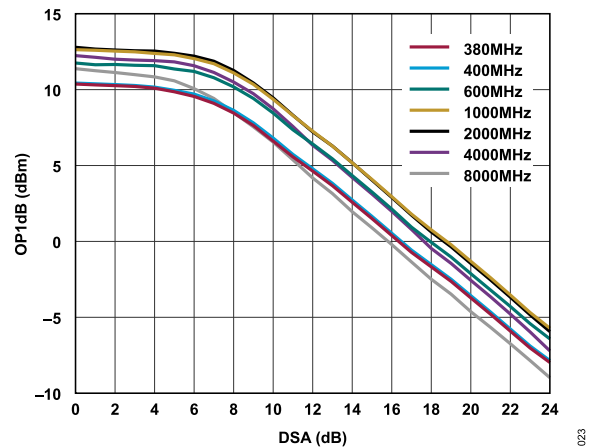

Figure 23. OP1dB vs. 1.0 dB DSA Steps for Various Frequencies

TYPICAL PERFORMANCE CHARACTERISTICS

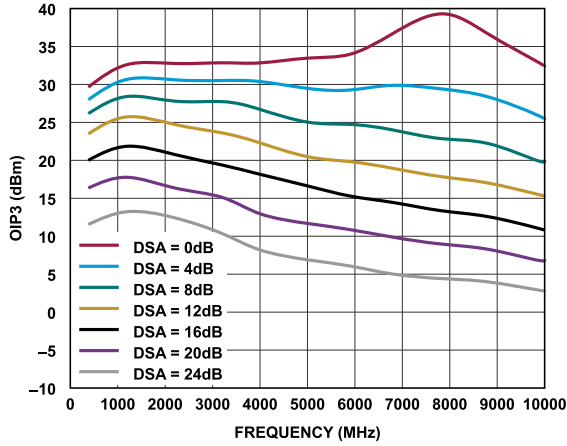

Figure 24. OIP3 vs. Frequency at Various DSA Values

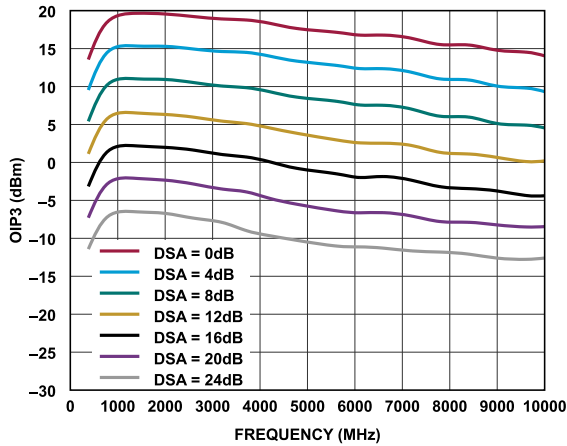

Figure 25. OIP3 vs. Frequency at Various DSA Values, AMP1 bypass

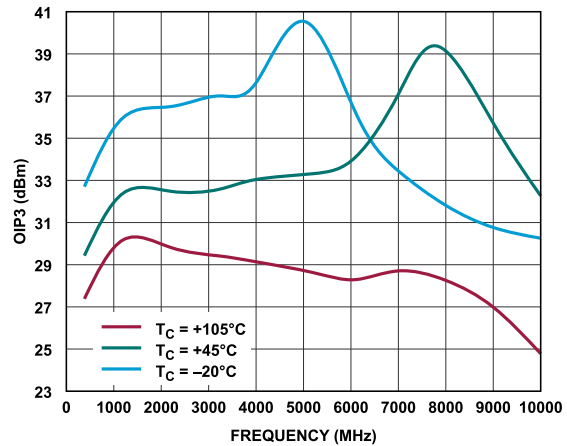

Figure 26. OIP3 vs. Frequency for Various Temperatures

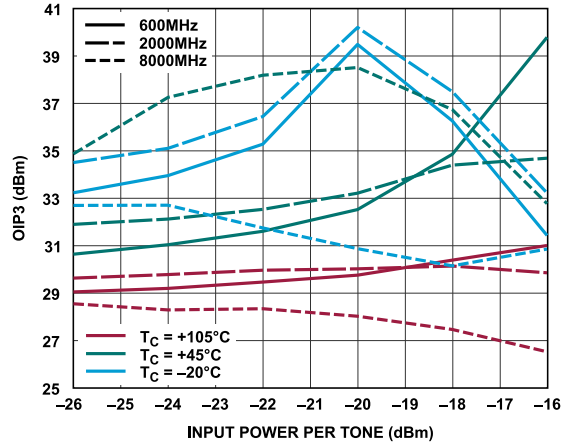

Figure 27. OIP3 vs. Input Power Per Tone for Various Temperatures at 600 MHz, 2000 MHz and 8000 MHz

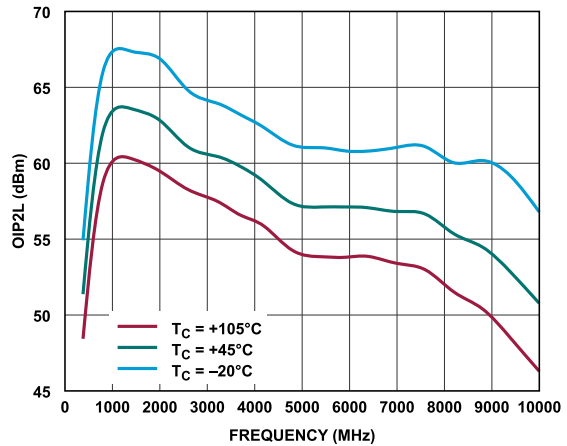

Figure 28. OIP2L vs. Frequency for Various Temperatures

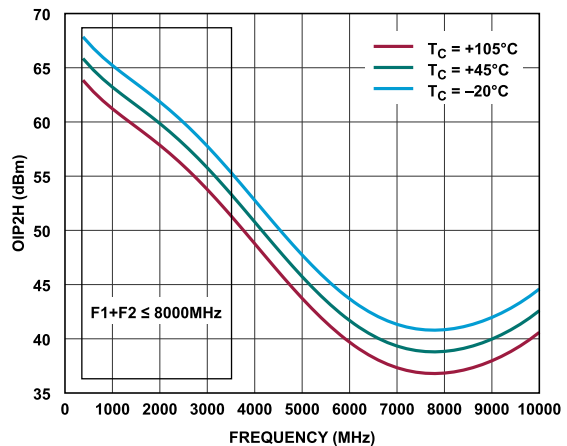

Figure 29. OIP2H vs. Frequency for Various Temperatures, Tone Spacing Equals to 1010 MHz

TYPICAL PERFORMANCE CHARACTERISTICS

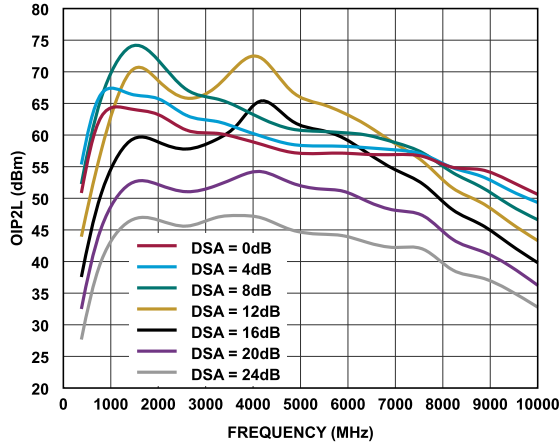

Figure 30. OIP2L vs. Frequency at Various DSA Values

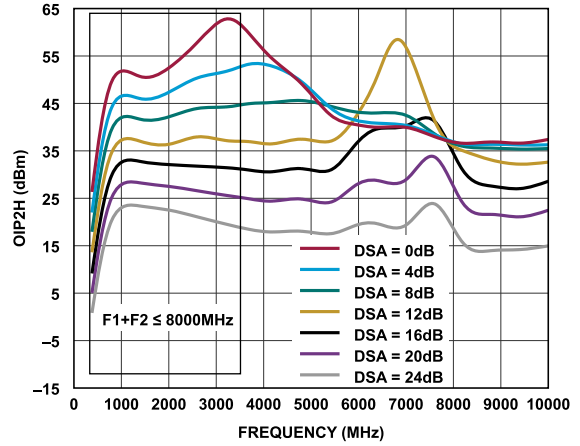

Figure 33. OIP2H vs. Frequency at Various DSA Values, AMP1 Bypass, Tone Spacing Equals to 1010 MHz

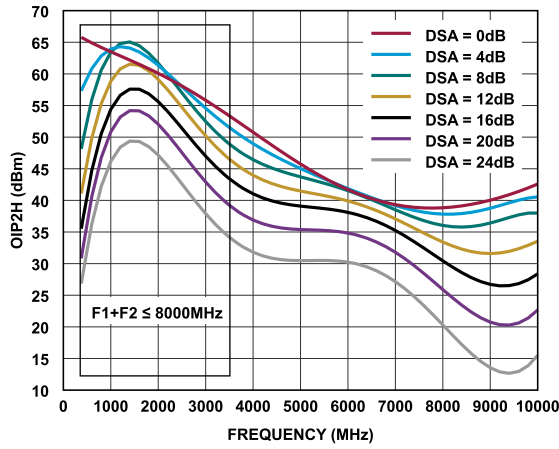

Figure 31. OIP2H vs. Frequency at Various DSA Values, Tone Spacing Equals to 1010 MHz

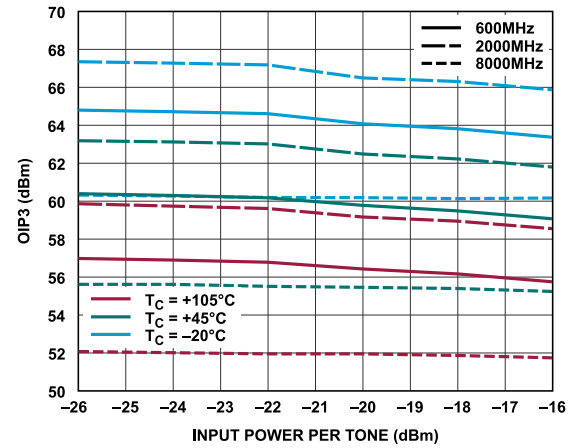

Figure 34. OIP2L vs. Input Power per Tone for Various Temperatures at 600 MHz, 2000 MHz and 8000 MHz

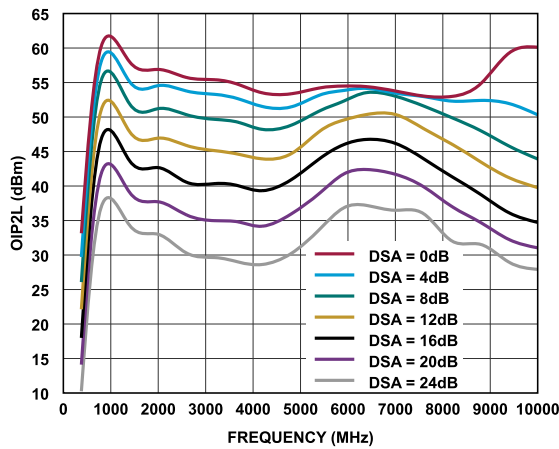

Figure 32. OIP2L vs. Frequency at Various DSA Values, AMP1 Bypass

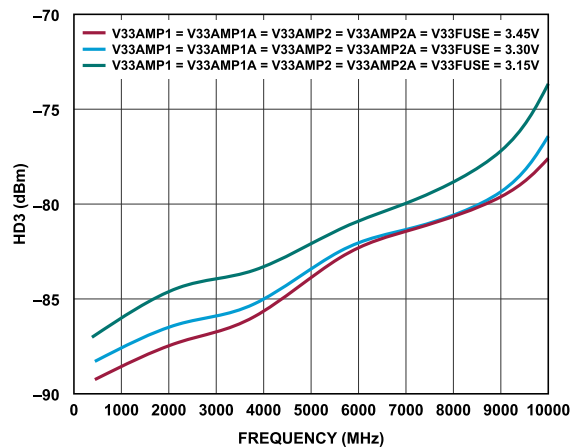

Figure 35. Third Harmonic Distortion (HD3) vs. Frequency for Various Supplies, Output Power Equals to -7 dBm

TYPICAL PERFORMANCE CHARACTERISTICS

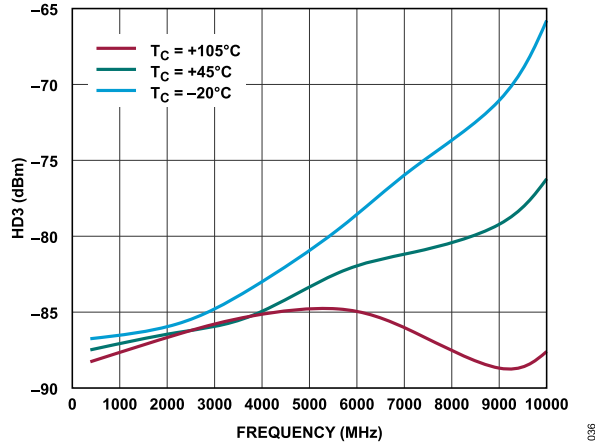

Figure 36. HD3 vs. Frequency for Various Temperatures, Output Power Equals to -7 dBm

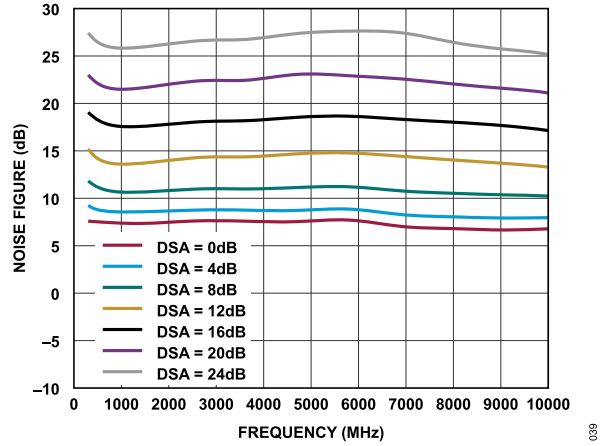

Figure 39. Noise Figure vs. Frequency at Various DSA Values

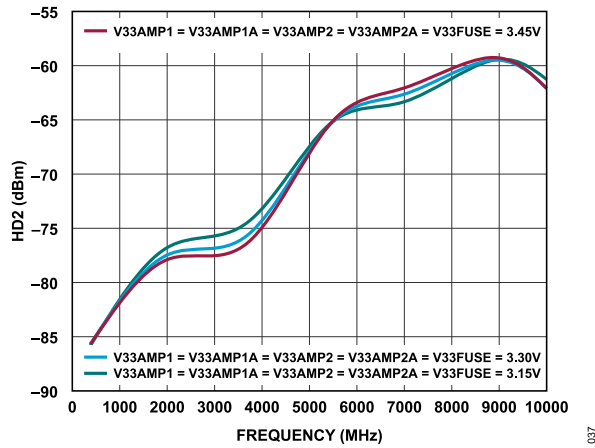

Figure 37. Second Harmonic Distortion (HD2) vs. Frequency for Various Supplies, Output Power Equals to -7 dBm

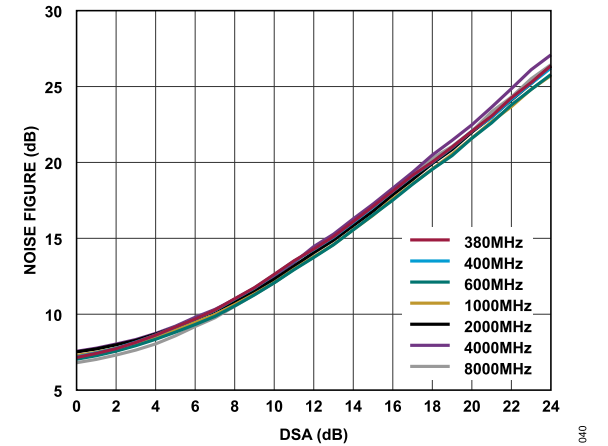

Figure 40. Noise Figure vs. 1.0 dB DSA Steps for Various Frequencies

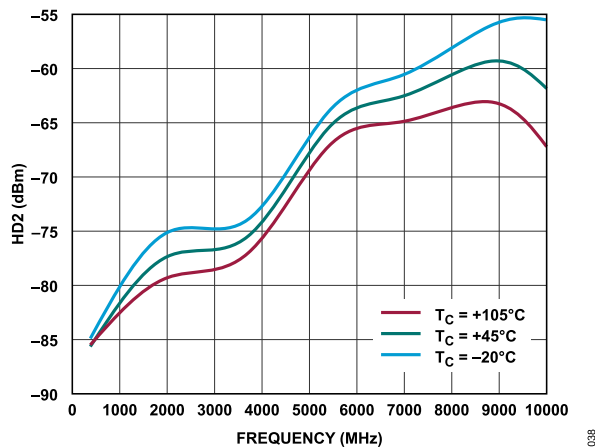

Figure 38. HD2 vs. Frequency for Various Temperatures, Output Power Equals to -7 dBm

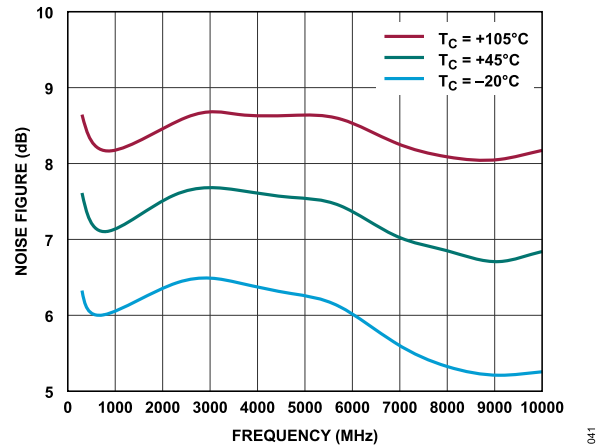

Figure 41. Noise Figure vs. Frequency for Various Temperatures

TYPICAL PERFORMANCE CHARACTERISTICS

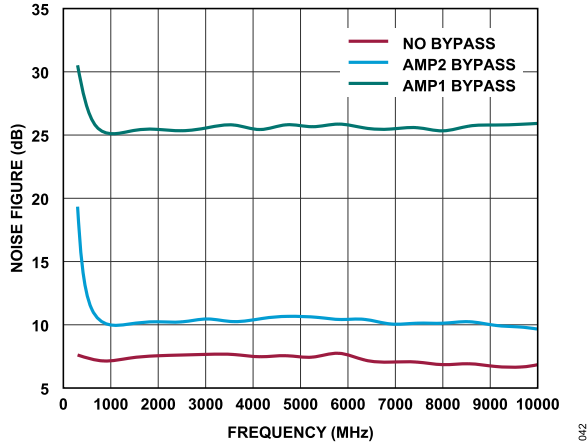

Figure 42. Noise Figure vs. Frequency for Various Bypass Modes

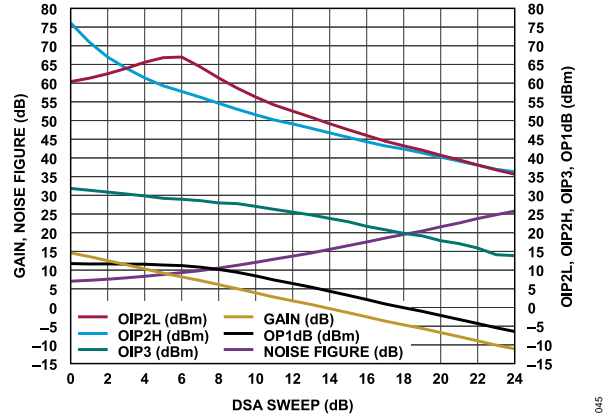

Figure 45. Gain, Noise Figure, OIP2L, OIP2H, OIP3, OP1dB vs. DSA Sweep, Frequency = 600 MHz

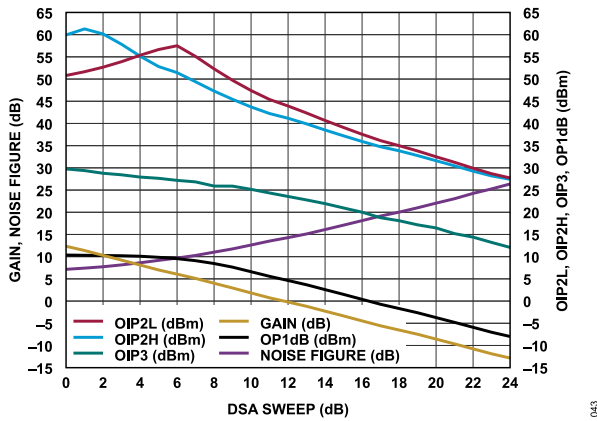

Figure 43. Gain, Noise Figure, OIP2L, OIP2H, OIP3, OP1dB vs. DSA Sweep, Frequency = 380 MHz

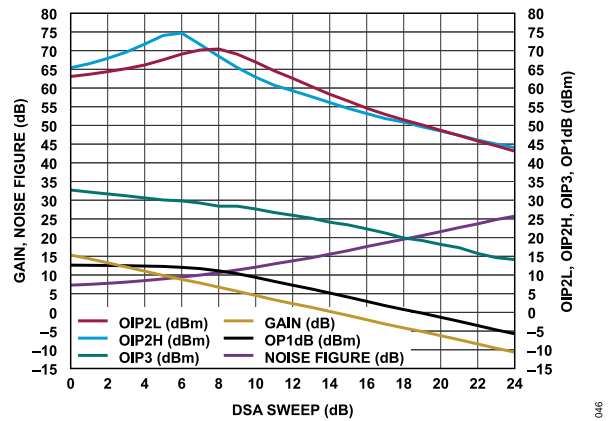

Figure 46. Gain, Noise Figure, OIP2L, OIP2H, OIP3, OP1dB vs. DSA Sweep, Frequency = 1000 MHz

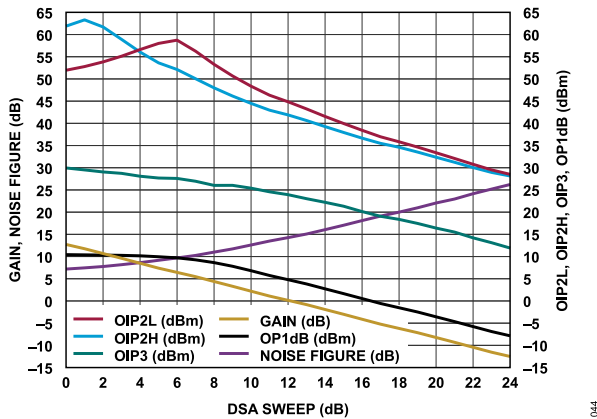

Figure 44. Gain, Noise Figure, OIP2L, OIP2H, OIP3, OP1dB vs. DSA Sweep, Frequency = 400 MHz

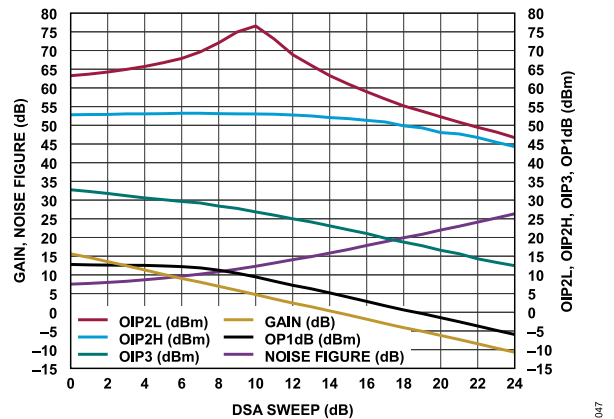

Figure 47. Gain, Noise Figure, OIP2L, OIP2H, OIP3, OP1dB vs. DSA Sweep, Frequency = 2000 MHz

TYPICAL PERFORMANCE CHARACTERISTICS

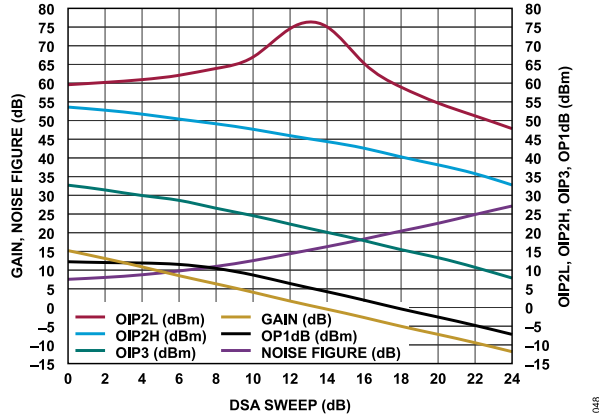

Figure 48. Gain, Noise Figure, OIP2L, OIP2H, OIP3, OP1dB vs. DSA Sweep, Frequency = 4000 MHz

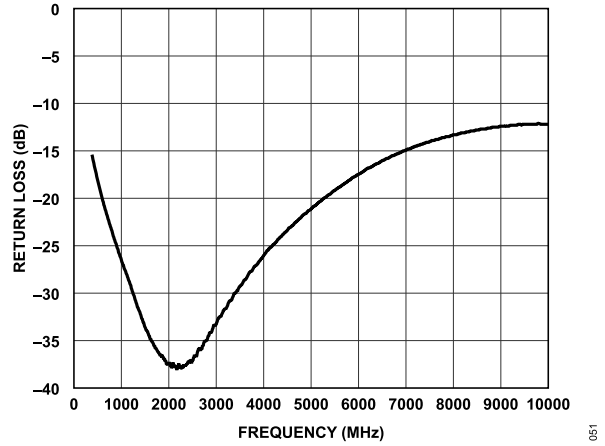

Figure 51. Return Loss of Differential RF Input S11 at 50 Ω Match

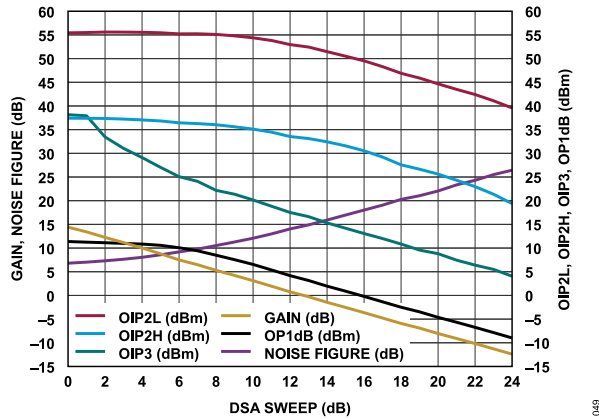

Figure 49. Gain, Noise Figure, OIP2L, OIP2H, OIP3, OP1dB vs. DSA Sweep, Frequency = 8000 MHz

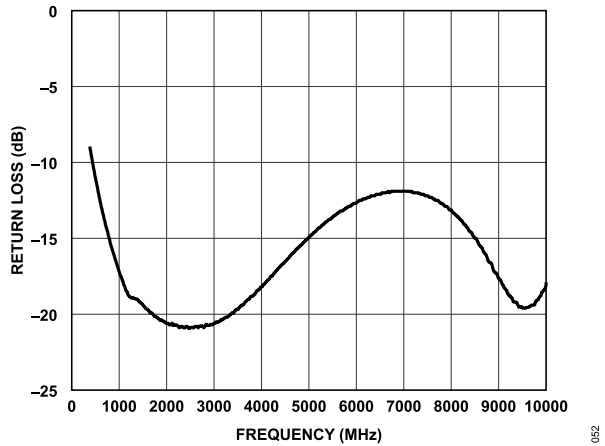

Figure 52. Return Loss of Single-Ended RF Output S22 at 50 Ω Match

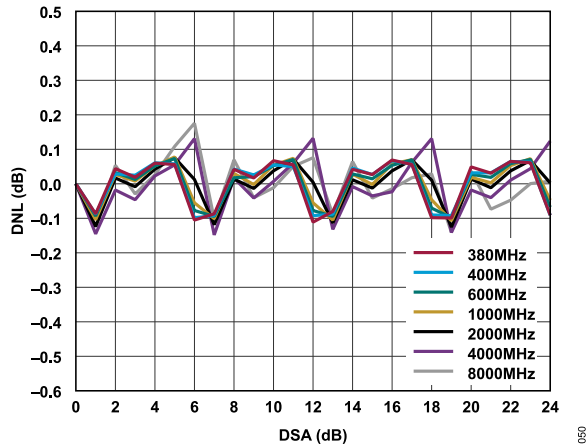

Figure 50. DSA Gain Step Error

TYPICAL PERFORMANCE CHARACTERISTICS

ADL6331-B

$V_{33AMP1} = V_{33AMP1A} = V_{33AMP2} = V_{33AMP2A} = V_{33FUSE} = 3.3\text{ V}$, $T_A = 25^\circ\text{C}$, fixed gain mode, DSA attenuation = 0 dB, $R_S = 50\ \Omega$ differential, and $R_L = 50\ \Omega$ single-ended, unless otherwise noted. Refer to the [AMP1 and AMP2 Trimming and Tuning](#) section for OIP3 optimization.

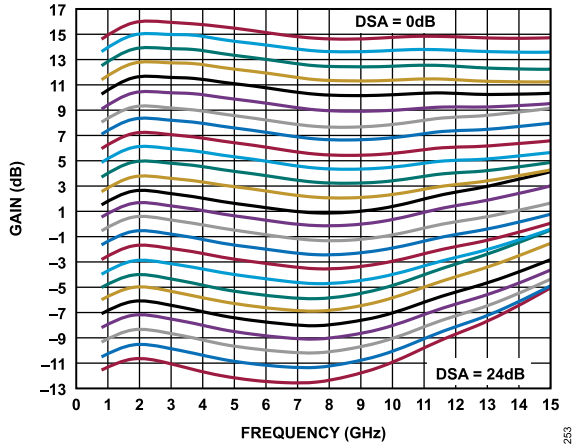

Figure 53. Gain vs. Frequency, 1.0 dB DSA Steps

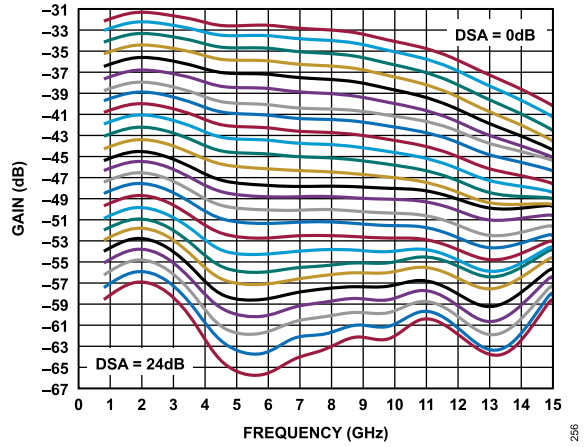

Figure 56. Gain vs. Frequency, 1.0 dB DSA Steps, AMP1 and AMP2 Bypass

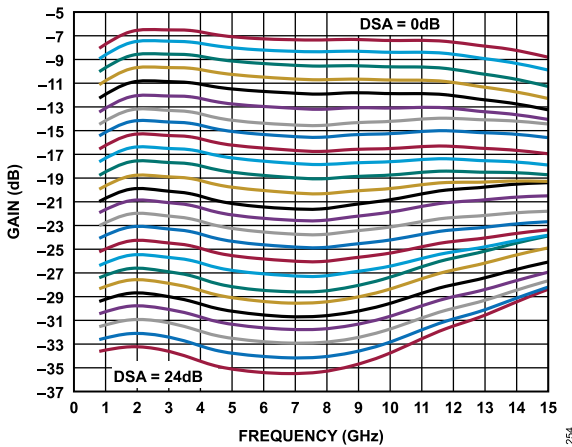

Figure 54. Gain vs. Frequency, 1.0 dB DSA Steps, AMP2 Bypass

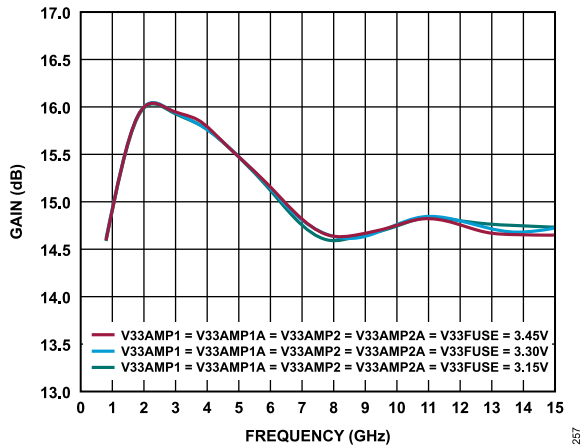

Figure 57. Gain vs. Frequency for Various Supplies

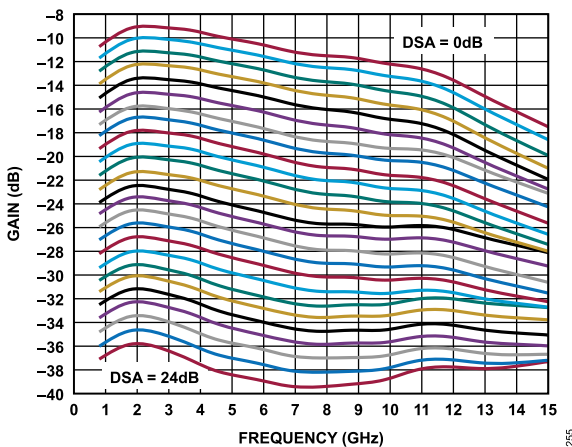

Figure 55. Gain vs. Frequency, 1.0 dB DSA Steps, AMP1 Bypass

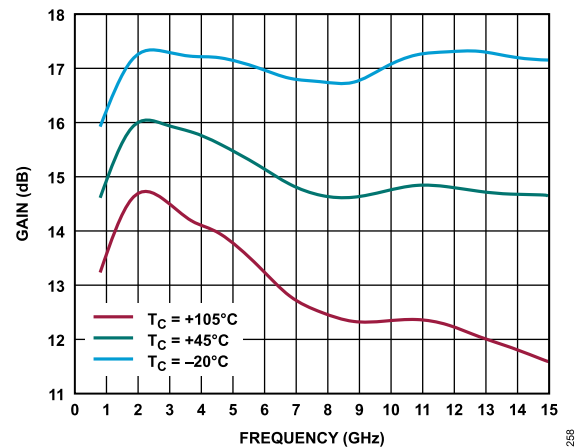

Figure 58. Gain vs. Frequency for Various Temperatures

TYPICAL PERFORMANCE CHARACTERISTICS

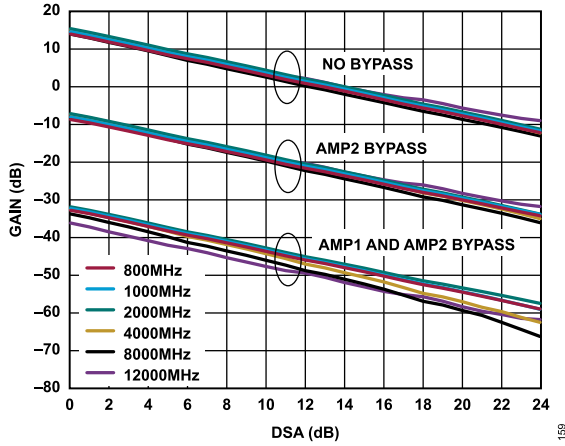

Figure 59. Gain vs. 1.0 dB DSA Steps for Various Frequencies, AMP2 Bypass

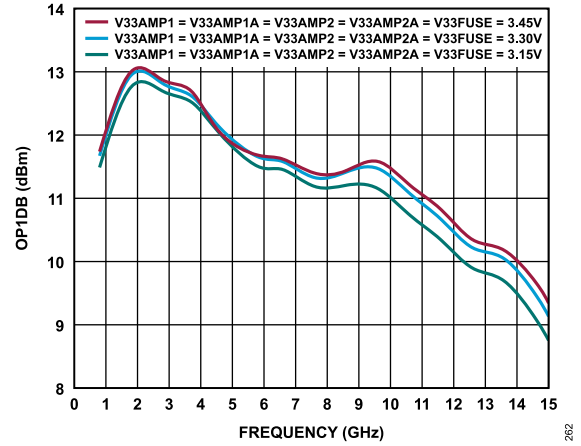

Figure 62. OP1dB vs. Frequency for Various Supplies

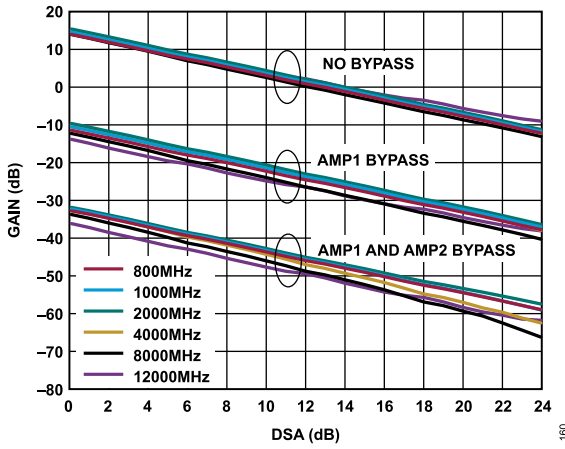

Figure 60. Gain vs. 1.0 dB DSA Steps for Various Frequencies, AMP1 Bypass

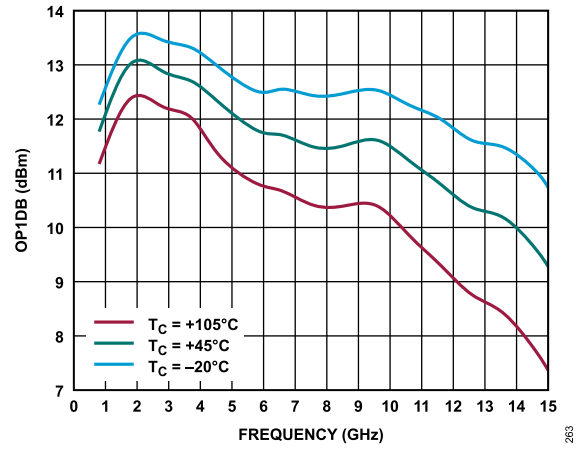

Figure 63. OP1dB vs. Frequency for Various Temperatures

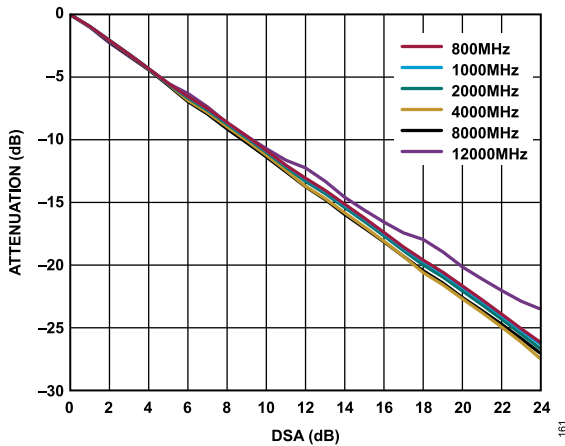

Figure 61. Attenuation vs. DSA for Various Frequencies

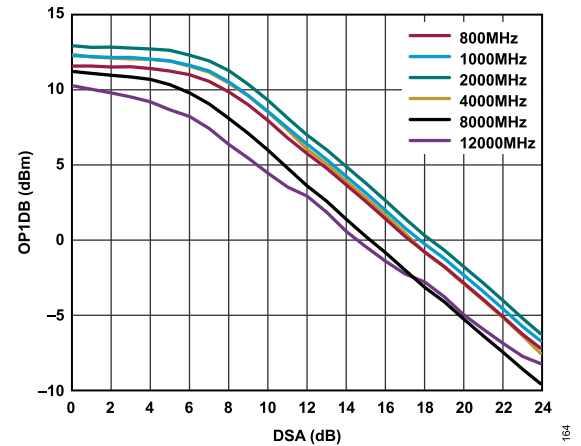

Figure 64. OP1dB vs. 1.0 dB DSA Steps for Various Frequencies

TYPICAL PERFORMANCE CHARACTERISTICS

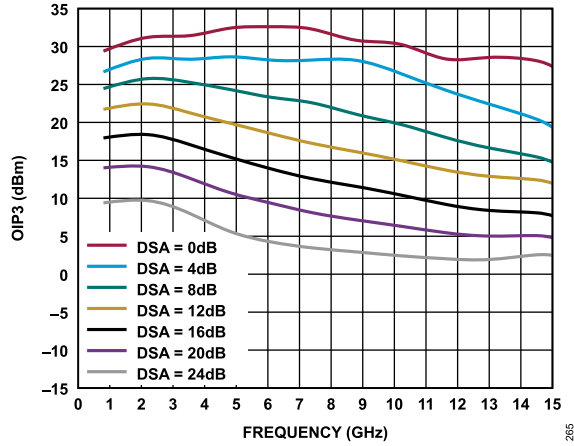

Figure 65. OIP3 vs. Frequency at Various DSA Values

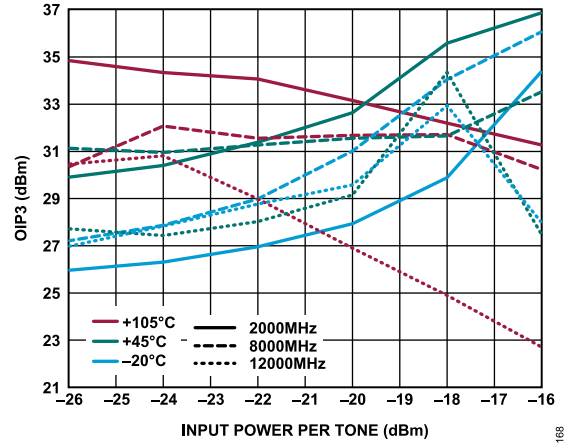

Figure 68. OIP3 vs. Input Power Per Tone for Various Temperatures at 2000 MHz, 8000 MHz, and 12000 MHz

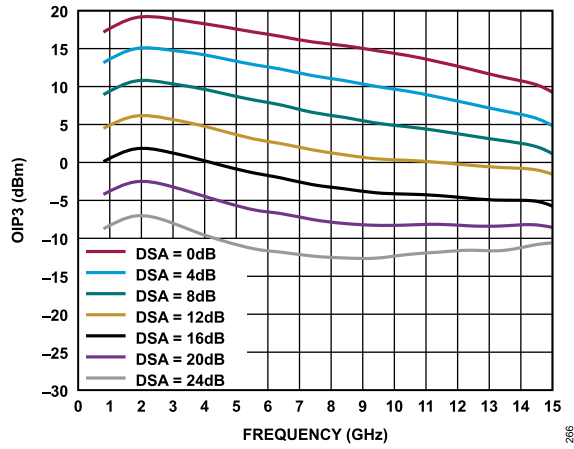

Figure 66. OIP3 vs. Frequency at Various DSA Values, AMP1 Bypass

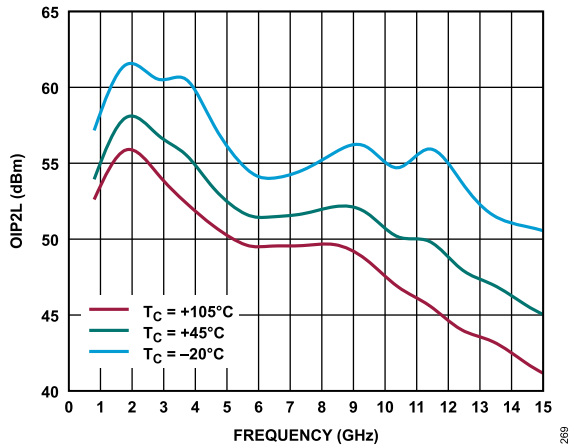

Figure 69. OIP2L vs. Frequency for Various Temperatures

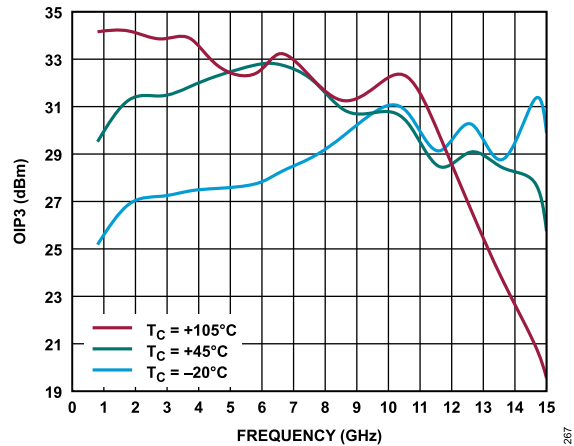

Figure 67. OIP3 vs. Frequency for Various Temperatures

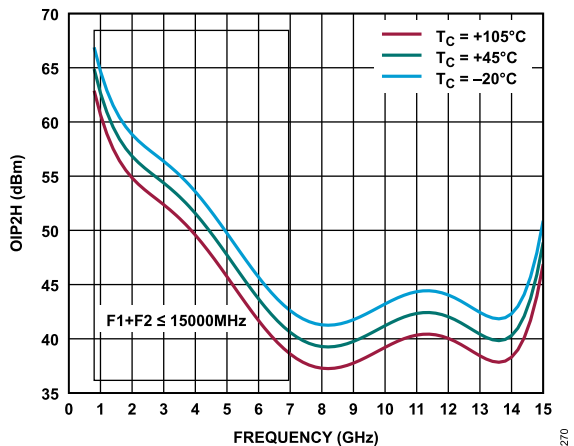

Figure 70. OIP2H vs. Frequency for Various Temperatures, Tone Spacing Equals to 1010 MHz

TYPICAL PERFORMANCE CHARACTERISTICS

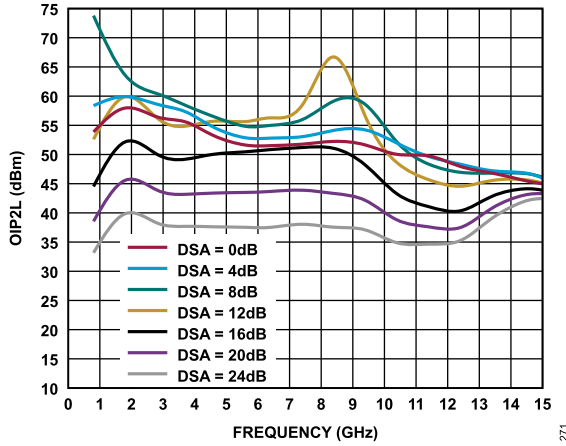

Figure 71. OIP2L vs. Frequency at Various DSA Values

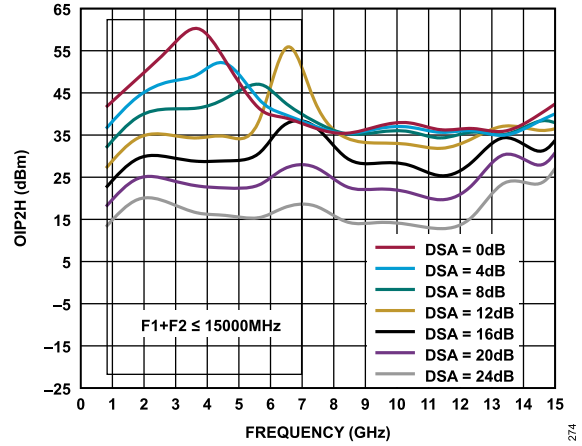

Figure 74. OIP2H vs. Frequency at Various DSA Values, AMP1 Bypass, Tone Spacing Equals to 1010 MHz

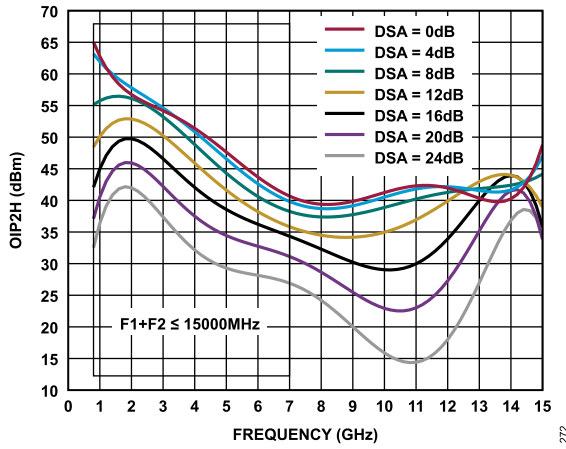

Figure 72. OIP2H vs. Frequency at Various DSA Values, Tone Spacing Equals to 1010 MHz

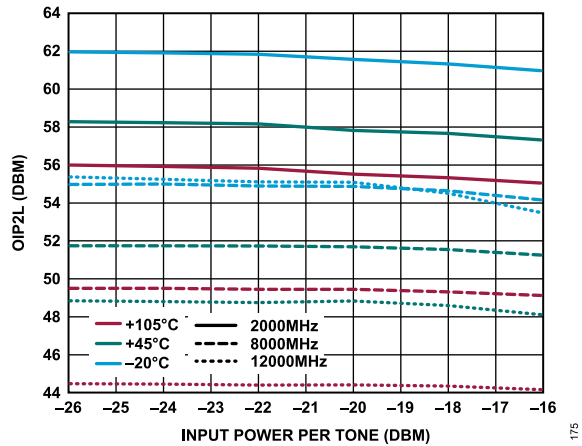

Figure 75. OIP2L vs. Input Power per Tone for Various Temperatures at 2000 MHz, 8000 MHz, and 12000 MHz

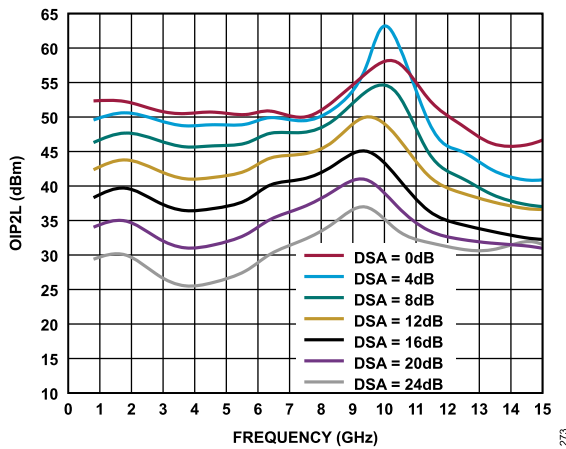

Figure 73. OIP2L vs. Frequency at Various DSA Values, AMP1 Bypass

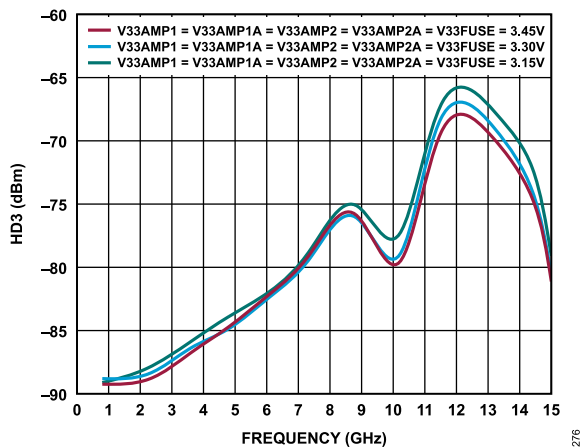

Figure 76. Third Harmonic Distortion (HD3) vs. Frequency for Various Supplies, Output Power Equals to -7 dBm

TYPICAL PERFORMANCE CHARACTERISTICS

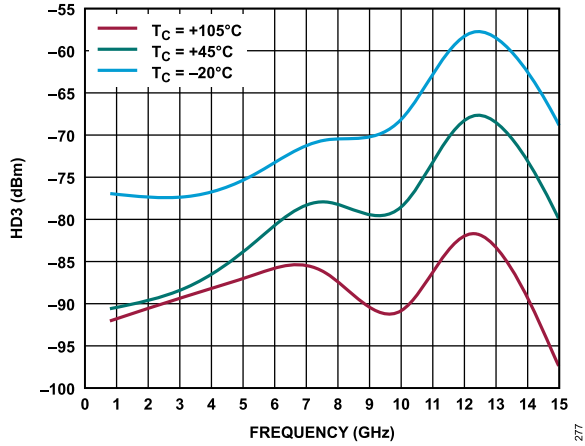

Figure 77. HD3 vs. Frequency for Various Temperatures, Output Power Equals to -7 dBm

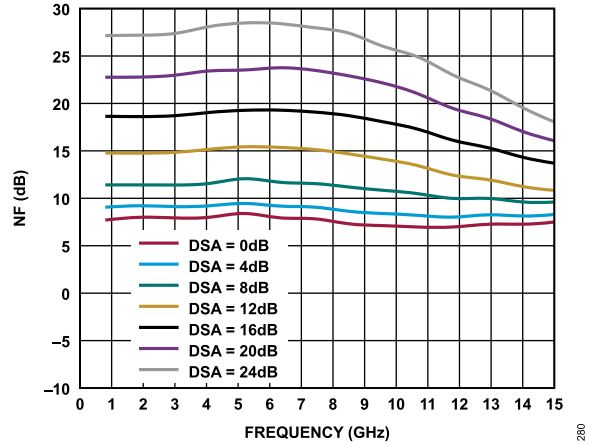

Figure 80. Noise Figure vs. Frequency at Various DSA Values

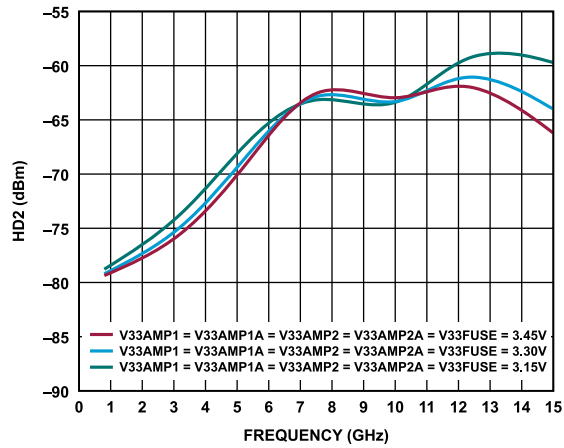

Figure 78. Second Harmonic Distortion (HD2) vs. Frequency for Various Supplies, Output Power Equals to -7 dBm

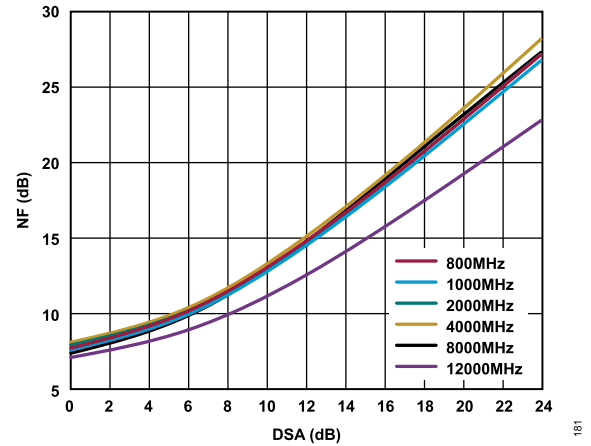

Figure 81. Noise Figure vs. 1.0 dB DSA Steps for Various Frequencies

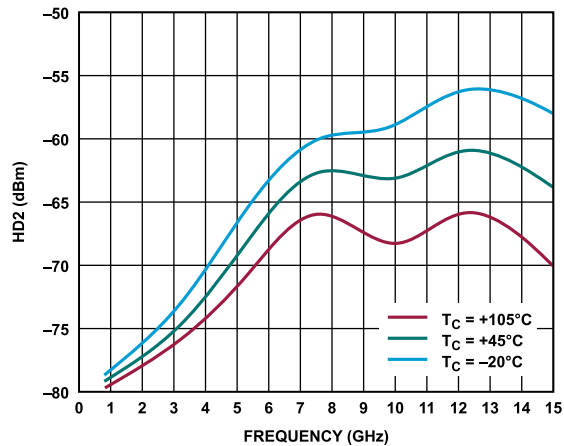

Figure 79. HD2 vs. Frequency for Various Temperatures, Output Power Equals to -7 dBm

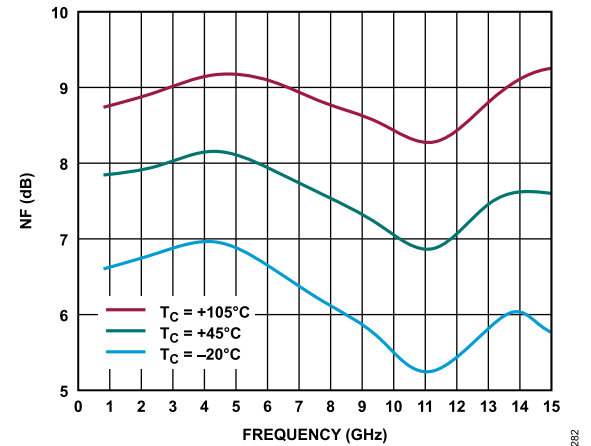

Figure 82. Noise Figure vs. Frequency for Various Temperatures

TYPICAL PERFORMANCE CHARACTERISTICS

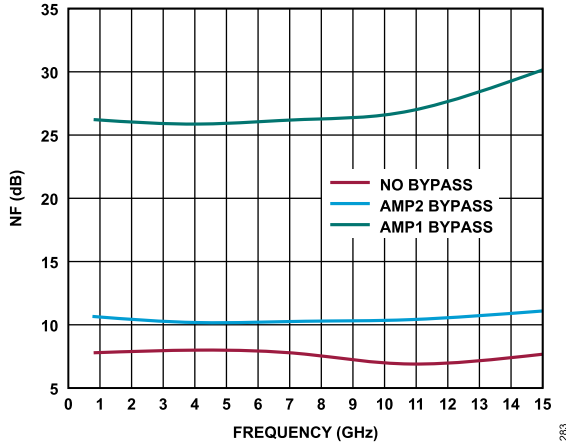

Figure 83. Noise Figure vs. Frequency for Various Bypass Modes

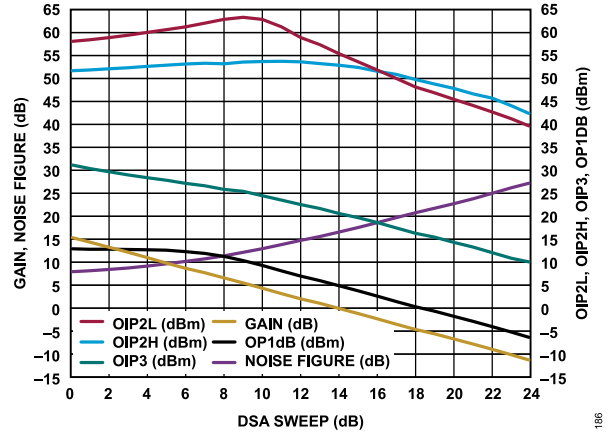

Figure 86. Gain, Noise Figure, OIP2L, OIP2H, OIP3, OP1dB vs. DSA Sweep, Frequency = 2000 MHz

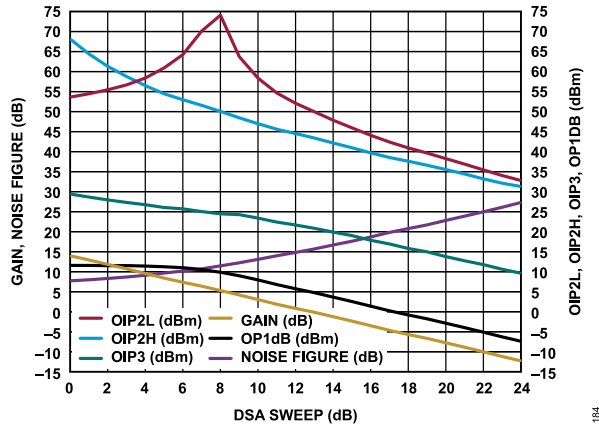

Figure 84. Gain, Noise Figure, OIP2L, OIP2H, OIP3, OP1dB vs. DSA Sweep, Frequency = 800 MHz

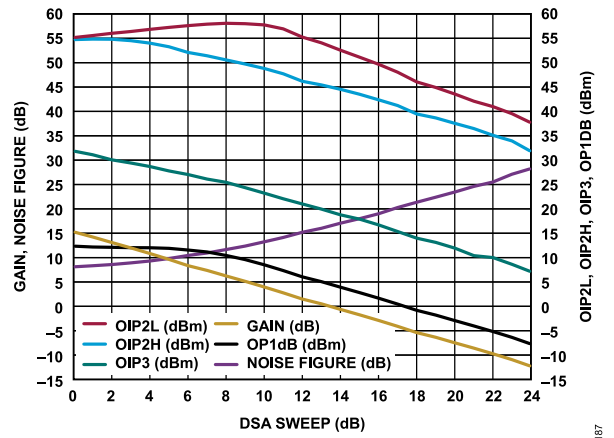

Figure 87. Gain, Noise Figure, OIP2L, OIP2H, OIP3, OP1dB vs. DSA Sweep, Frequency = 4000 MHz

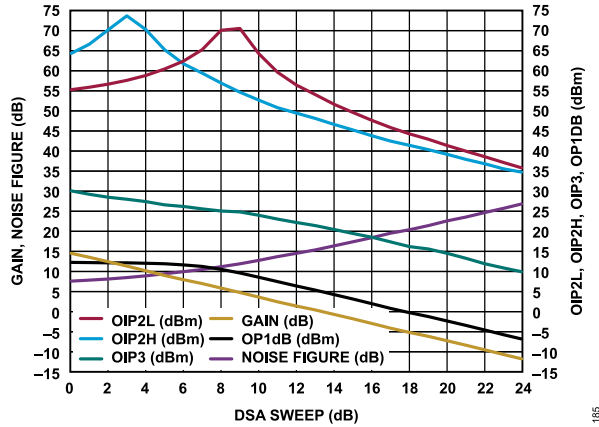

Figure 85. Gain, Noise Figure, OIP2L, OIP2H, OIP3, OP1dB vs. DSA Sweep, Frequency = 1000 MHz

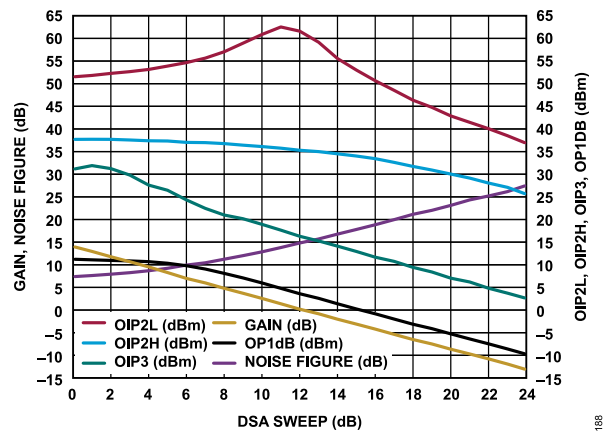

Figure 88. Gain, Noise Figure, OIP2L, OIP2H, OIP3, OP1dB vs. DSA Sweep, Frequency = 8000 MHz

TYPICAL PERFORMANCE CHARACTERISTICS

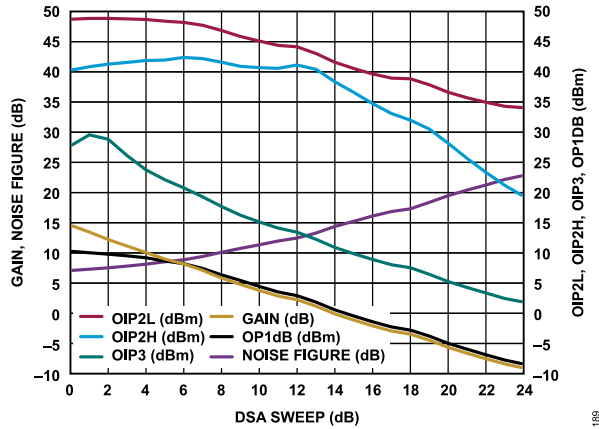

Figure 89. Gain, Noise Figure, OIP2L, OIP2H, OIP3, OP1dB vs. DSA Sweep, Frequency = 12000 MHz

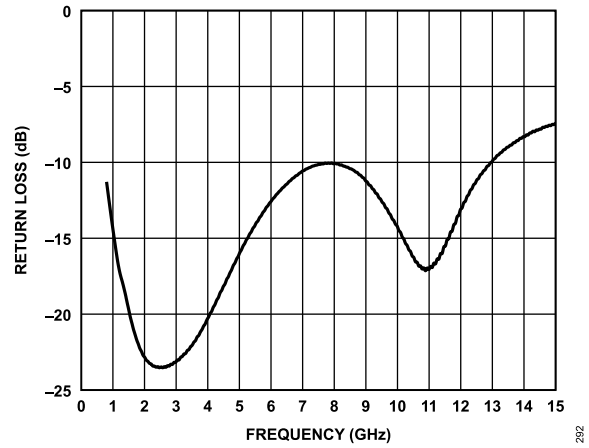

Figure 92. Return Loss of Single-Ended RF Output S22 at 50 Ω Match

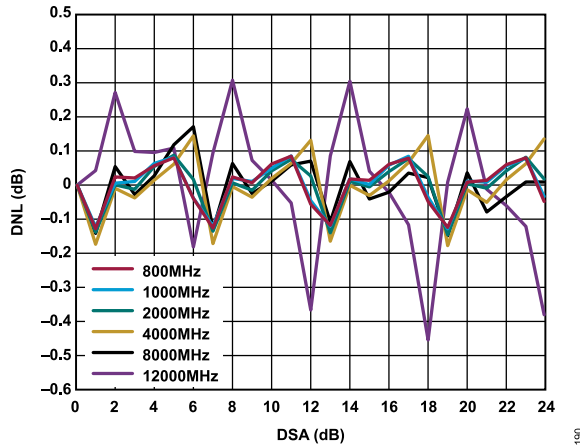

Figure 90. DSA Gain Step Error

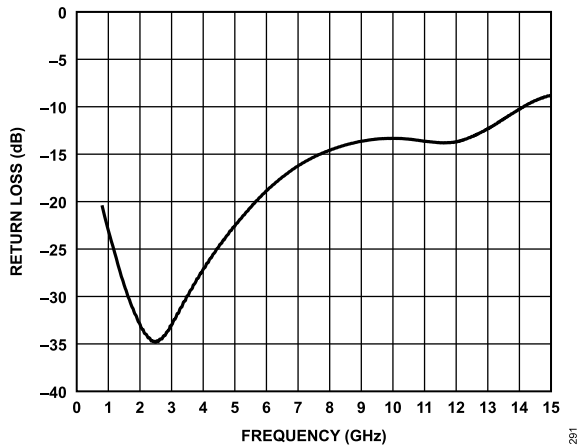

Figure 91. Return Loss of Differential RF Input S11 at 50 Ω Match

THEORY OF OPERATION

The ADL6331 integrates two amplifiers with fixed gain (AMP1 \approx 12 dB and AMP2 \approx 10 dB) and a DSA, which is adjustable from 0 dB to 24 dB in 1 dB step. The AMP1 and AMP2 have a bypass attenuation mode, which allows the user to disable these amplifiers individually and route the RF signals through the fixed 12 dB attenuators. When an amplifier is configured in the bypass attenuation mode, the gain drops by approximately 24 dB for AMP1 and 22 dB for AMP2 (Δ gain from AMP enabled to bypass attenuation mode), which enables an overall gain control range of 70 dB in 1 dB step when used with the 24 dB DSA.

Additionally, in the bypass attenuation mode, the current of the amplifiers drops to almost zero.

All circuit blocks of the ADL6331 as shown in [Figure 93](#) are programmable via the SPI.

RF INPUT AND OUTPUT

The ADL6331 input impedance is 50 Ω differential, and the output impedance is 50 Ω single-ended, which provides an interface from RF DACs with a 50 Ω differential output impedance to a 50 Ω single-ended PA in a signal chain without any matching networks.

PROGRAMMABILITY GUIDE

The register map can be subdivided into the seven functional groups, as shown in Table 7. See the Register Summary section for a complete list of all the registers on the ADL6331.

Table 7. Memory Map Functional Groups

Register Address	Functional Blocks
0x000 to 0x011	SPI configuration
0x100 to 0x101	Function enable
0x104 to 0x109	AMP1 performance trimming and tuning
0x10A to 0x10D	RF path 4 preconfigurations: AMP1, AMP2, Fixed gain/Bypass, DSA attenuation
0x10F to 0x115	AMP2 performance trimming and tuning
0x120 to 0x121	Auxiliary mux selection (Debug only), SPI supply control

Table 7. Memory Map Functional Groups (Continued)

Register Address	Functional Blocks
0x140 to 0x145	FUSE space. Read only. Trimmed parameters for AMP1 and AMP2 are stored.

FUNCTION AND SIGNAL PATH ENABLE

The enable bits for each circuit block are in Registers 0x100 and 0x101 (Table 8 and Table 9, respectively). Figure 93 shows a breakdown of the individual blocks highlighted in red that have corresponding enable controls in Register 0x100 and 0x101. The ENP pin is a primary enable pin for the ADL6331 and is active high. The bits in the enable registers can be configured independently of the state of the ENP pin.

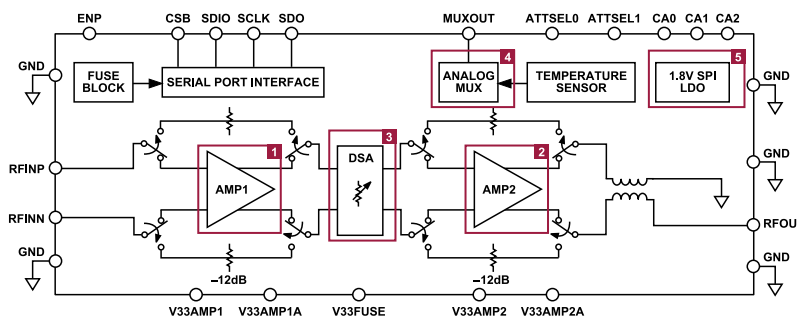

Figure 93. Signal Path Enable Block Diagram

Table 8. Register 0x100: Enable Register for MUX and LDO

Bits	Bit Name	Description	Reset	Access
[7:5]	RESERVED	Reserved.	0x0	R
4	AMUX_BG_EN	AMUX Bandgap Enable. If MUXOUT (Pin 7) is not used, set to 0. 0: Disable AMUX Bandgap. 1: Enable AMUX Bandgap.	0x1	R/W
3	RESERVED	Reserved.	0x0	R
2	RESERVED	Reserved.	0x0	R/W
1	RESERVED	Reserved.	0x0	R
0	LDO18_EN	1.8 V LDO Enable for AMUX Block. If MUXOUT (Pin 7) is not used, set to 0. 0: Disable. 1: Enable.	0x1	R/W

Table 9. Register 0x101: Enable Register for AMP1/AMP2 and DSA

Bits	Bit Name	Description	Reset	Access
[7:3]	RESERVED	Reserved.	0x0	R
2	AMP2_EN	AMP2 Enable. 0: Disable. 1: Enable.	0x0	R/W
1	RESERVED	DSA Enable. 0: Disable. 1: Enable.	0x0	R/W
0	LDO18_EN	AMP1 Enable. 0: Disable. 1: Enable.	0x0	R/W

PROGRAMMABILITY GUIDE

AMP1 AND AMP2 TRIMMING AND TUNING

Initial optimization of the amplifiers is performed at the factory, and the optimized and trimmed parameters are stored in the nonvolatile memory (NVM) referred to as the FUSE block. When the MSB in Register 0x104, Register 0x105, and Register 0x106 for AMP1 and in Register 0x110, Register 0x111, and Register 0x112 for AMP2 is 1 (Default), the factory trimmed parameters are automatically used in the operation (normal operation mode). These values are readable in Register 0x140, Register 0x141, Register 0x142, Register 0x143, Register 0x144, and Register 0x145 (Table 16). When the MSB in Register 0x104, Register 0x105, and Register 0x106 for AMP1 and Register 0x110, Register 0x111, and Register 0x112 for AMP2 is set to 0, the following registers are tunable by the user:

- ▶ AMP1_IGREF in Register 0x104
- ▶ AMP1_IDREF_Z in Register 0x105
- ▶ AMP1_IDREF_P in Register 0x106
- ▶ AMP2_IGREF in Register 0x110
- ▶ AMP2_IDREF_Z in Register 0x111
- ▶ AMP2_IDREF_P in Register 0x112

Use the default (reset) values in Register 0x103 to Register 0x115 in Table 10 for the ADL6331-A only. For the ADL6331-B, to achieve the optimal performance of OIP3 over its wide frequency range, both AMP1_CROSS_Z in Register 0x107 and AMP2_CROSS_Z in Register 0x113 need to be set to 0. If the lower current consumption is required, see the Applications Information section.

Table 10. AMP1 and AMP2 Trimming and Tuning Register

Reg	Bits	Bit 7	Bit 6	Bit 5	Bit 4	Bit 3	Bit 2	Bit 1	Bit 0
0x103	[7:0]	RESERVED				AMP1_MON_EN	AMP1_CROSS_EN	AMP1_IM3_EN	AMP1_LP_MODE
0x104	[7:0]	NVM_TRM_A MP1_IGREF	RESERVED			AMP1_IGREF			
0x105	[7:0]	NVM_TRM_A MP1_IDREF_Z	RESERVED	AMP1_IDREF_Z					
0x106	[7:0]	NVM_TRM_A MP1_IDREF_P	RESERVED			AMP1_IDREF_P			
0x107	[7:0]	RESERVED			AMP1_CROSS_Z				
0x108	[7:0]	RESERVED				AMP1_CROSS_P			
0x109	[7:0]	SPARE_010B				AMP1_IM3_CAP			
0x10F	[7:0]	RESERVED				AMP2_MON_EN	AMP2_CROSS_EN	AMP2_IM3_EN	AMP2_LP_MODE
0x110	[7:0]	NVM_TRM_A MP2_IGREF	RESERVED			AMP2_IGREF			
0x111	[7:0]	NVM_TRM_A MP2_IDREF_Z	RESERVED	AMP2_IDREF_Z					
0x112	[7:0]	NVM_TRM_A MP2_IDREF_P	RESERVED			AMP2_IDREF_P			
0x113	[7:0]	RESERVED			AMP2_CROSS_Z				
0x114	[7:0]	RESERVED				AMP2_CROSS_P			
0x115	[7:0]	SPARE_011B				AMP2_IM3_CAP			

PROGRAMMABILITY GUIDE

RF PATH PRECONFIGURATION

ADL6331 has four preconfigurable RF gain settings that are selected with the ATTSEL0 and ATTSEL1 pins. The configurable parameters (Fixed gain or Bypass attenuation mode in AMP1 and AMP2, and DSA attenuation level) are stored in 4-register spaces (Table 11, Table 12, Table 13, Table 14, Table 15), which are called RF State A, State B, State C, and State D.

- ▶ State A: SIG_PATH0_2 in Register 0x10A

- ▶ State B: SIG_PATH1_2 in Register 0x10B
- ▶ State C: SIG_PATH2_2 in Register 0x10C
- ▶ State D: SIG_PATH3_2 in Register 0x10D

Each mode can configure the full RF chain after reset is asserted. Default settings for each mode are shown in Table 11. Users can overwrite the parameters before or during operation.

This feature allows the users to switch the RF performance rapidly using asynchronous external control.

Table 11. Four Preconfiguration Registers with Default and Reset RF Parameters

RF State	ATTSEL1 (Pin 6)	ATTSEL0 (Pin 13)	Register Address	Register Name	Bits	Bit 7	Bit 6	Bits[5:0], DSA Setting 0 dB to 24.0 dB at 1.0 dB Step
						AMP2 Setting: Bypass attenuation/ Fixed Gain	AMP1 Setting: Bypass attenuation/ Fixed Gain	
A	0	0	0x10A	SIG_PATH0_2	[7:0]	Default = bypass attenuation	Default = bypass attenuation	Default = 24.0 dB attenuation
B	0	1	0x10B	SIG_PATH1_2	[7:0]	Default = fixed gain	Default = fixed gain	Default = 16.0 dB attenuation
C	1	0	0x10C	SIG_PATH2_2	[7:0]	Default = fixed gain	Default = fixed gain	Default = 8.0 dB attenuation
D	1	1	0x10D	SIG_PATH3_2	[7:0]	Default = fixed gain	Default = fixed gain	Default = 0.0 dB attenuation

Table 12. Register 0x10A: State A

Bits	Bit Name	Description	Reset	Access
7	AMP2_BYPASS0	Amplifier 2 bypass State A setting 0: Fixed gain mode 1: Bypass attenuation mode	0x1	R/W
6	AMP1_BYPASS0	Amplifier 1 bypass State A setting 0: Fixed gain mode 1: Bypass attenuation mode	0x1	R/W
[5:0]	DSA_ATT0	DSA attenuator State A setting 0: 0 dB 1: 1 dB 2: 2 dB ... 24: 24 dB	0x18	R/W

Table 13. Register 0x10B: State B

Bits	Bit Name	Description	Reset	Access
7	AMP2_BYPASS1	Amplifier 2 bypass State B setting 0: Fixed gain mode 1: Bypass attenuation mode	0x0	R/W
6	AMP1_BYPASS1	Amplifier 1 bypass State B setting 0: Fixed gain mode 1: Bypass attenuation mode	0x0	R/W
[5:0]	DSA_ATT1	DSA attenuator State B setting 0: 0 dB 1: 1 dB ...	0x10	R/W

PROGRAMMABILITY GUIDE

Table 13. Register 0x10B: State B (Continued)

Bits	Bit Name	Description	Reset	Access
		16: 16 dB ... 24: 24 dB		

Table 14. Register 0x10C: State C

Bits	Bit Name	Description	Reset	Access
7	AMP2_BYPASS2	Amplifier 2 bypass State C setting 0: Fixed gain mode 1: Bypass attenuation mode	0x0	R/W
6	AMP1_BYPASS2	Amplifier 1 bypass State C setting 0: Fixed gain mode 1: Bypass attenuation mode	0x0	R/W
[5:0]	DSA_ATT2	DSA attenuator State C setting 0: 0 dB 1: 1 dB ... 8: 8 dB ... 24: 24 dB	0x8	R/W

Table 15. Register 0x10D: State D

Bits	Bit Name	Description	Reset	Access
7	AMP2_BYPASS3	Amplifier 2 bypass State D setting 0: Fixed gain mode 1: Bypass attenuation mode	0x0	R/W
6	AMP1_BYPASS3	Amplifier 1 bypass State D setting 0: Fixed gain mode 1: Bypass attenuation mode	0x0	R/W
[5:0]	DSA_ATT3	DSA attenuator State D setting 0: 0 dB 1: 1 dB ... 24: 24 dB	0x0	R/W

AUXILIARY MUX OUT/TEMPERATURE SENSOR

The ADL6331 has multiple auxiliary mux control blocks that allow various modes of operation and monitoring point. All are available to the user, but many parameters are used for monitoring during the manufacturing process by Analog Devices, Inc. The default (reset) register configuration allows users to monitor an internal voltage that is proportional to temperature, which can be used to track temperature changes from MUXOUT Pin 7. If the user does not need to use the temperature sensor feature, it may be disabled by setting zeros in AMUX_BG_EN[4] and LDO18_EN[0] at 0x100 register.

NVM (FUSE) SPACE (REFERENCE ONLY)

The non-volatile memory (NVM) space is invisible to the user, but values from NVM are loaded to Registers 0x140, 0x141, 0x142, 0x143, 0x144, 0x145 (Table 16). These values are used when the MSB in Register 0x104, Register 0x105, and Register 0x106 for AMP1 and Register 0x110, Register 0x111, and Register 0x112 for AMP2 is 1 (default/reset).

PROGRAMMABILITY GUIDE

Table 16. NVM Register

Register Address	Register Name	Bits	Bit 7	Bit 6	Bit 5	Bit 4	Bit 3	Bit 2	Bit 1	Bit 0
0x140	FUSE_REA DBACK_0	[7:0]	RESERVED				TRM_AMP1_IGREF_RDBK			
0x141	FUSE_REA DBACK_1	[7:0]	RESERVED		TRM_AMP1_IDREF_Z_RDBK					
0x142	FUSE_REA DBACK_2	[7:0]	RESERVED				TRM_AMP1_IDREF_P_RDBK			
0x143	FUSE_REA DBACK_3	[7:0]	RESERVED				TRM_AMP2_IGREF_RDBK			
0x144	FUSE_REA DBACK_4	[7:0]	RESERVED		TRM_AMP2_IDREF_Z_RDBK					
0x145	FUSE_REA DBACK_5	[7:0]	RESERVED				TRM_AMP2_IDREF_P_RDBK			

SERIAL PORT INTERFACE (SPI)

The SPI of the ADL6331 allows the user to configure the device for specific functions or operations via 3- or 4-wire SPI mode. This serial port interface consists of four control lines: SCLK, SDIO, SDO, and CSB for 4-wire SPI mode. SCLK, SDIO, and CSB are used for 3-wire SPI mode, which is the default state for the SPI mode. To enable 4-wire SPI mode, SDOACTIVE[3] and SDOACTIVE_[4] in Register 0x000 should be set to 1. The timing requirements for the SPI port are shown in Table 3.

The ADL6331 protocol consists of a read/write bit, four chip address bits (MSB is always 0), and nine register address bits, followed by eight data bits. Both the address and data fields are organized with the MSB first and end with the LSB by default. To address the device correctly, the chip address prefix bits must match the externally configured chip address Pin CA2, Pin CA1, and Pin CA0.

The ADL6331 input logic levels to write to the SPI are 1.8 V or 3.3 V.

On a readback cycle, the SDO is configurable for either 1.8 V (default) or 3.3 V readback output levels by setting SPI_1P8_3P3_CTRL bit (Register 0x121, Bit 4).

CONFIGURING MULTIPLE CHIPS TO SHARE THE SPI BUS

Up to eight ADL6331 devices can be addressed with the same 3- or 4-wire SPI by using a single CSB line for all devices. For this capability, the chip address pins (Pin CA2, Pin CA1, and Pin CA0) of the ADL6331 are used to identify the chip with the SPI write chip address prefix (see the SPI interface port as shown in Figure 2).

The ADL6331 ignores any writes to addresses where the four MSBs are not equal to the chip address as set by the chip address pins, and the device only accepts access for addresses where the four MSB chip address prefix bits are equal to the chip address pins. The only exception is the software reset in the address 0x000. All ADL6331 chips on the shared bus accept 0x81 software reset in 0x000 register from the SPI host controller.

Figure 94 shows how to configure the chip address Pin CA2, Pin CA1, and Pin CA0 with the associated chip address prefix bits.

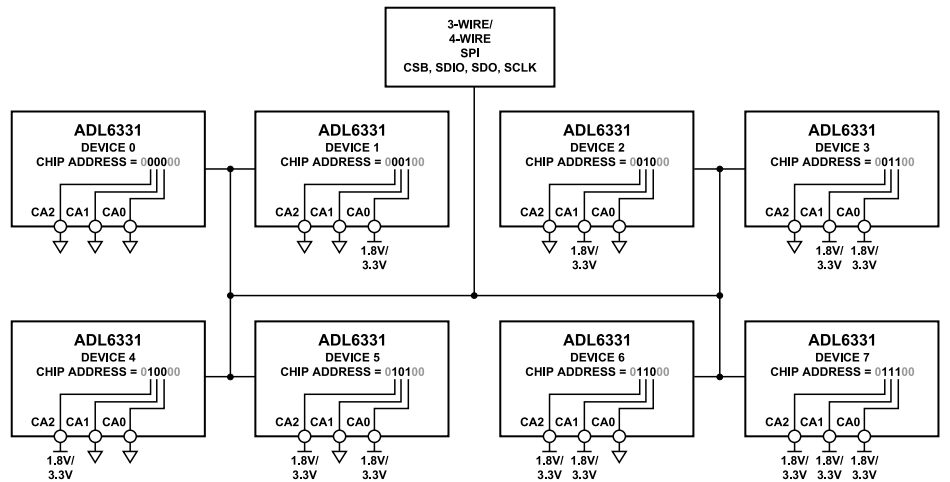

Figure 94. Multiple Chip Configuration to Share SPI Bus

SERIAL PORT INTERFACE (SPI)

INITIALIZATION SEQUENCE

The ADL6331 has a built-in initialization sequence that is triggered by a software reset to correctly load data from the NVM into the memory for normal amplifier operation. The calibrated and trimmed settings for AMP1 and AMP2 are factory programmed and stored in NVM prior to shipping to the user. After a software reset is performed, the data in the NVM needs to be loaded into the digital Register 0x140 to Register 0x145 for operation. This loading process takes four SPI cycles, write or read, after the software reset is asserted. The loading process is independent of the state of the ENP pin, high or low.

The full procedure for initializing the part is as follows:

1. Supply 3.3 V.
2. Apply software reset.
3. Send four SPI commands to ADL6331 (read or write).

The software reset, sending 0x81 in Register 0x000, is always recommended immediately after the 3.3 V is supplied.

After the 3.3 V is supplied, perform the following steps as shown in [Table 17](#)):

1. Write 0x81 in Register 0x000 for the software reset.
2. Write 0x18 in Register 0x000 for configuring 4-wire SPI mode.
3. Write 0x01 in Register 0x00A¹.
4. Write 0x02 in Register 0x00A.
5. Write 0x03 in Register 0x00A.
6. Write 0x07 in Register 0x101 to enable the AMP2, DSA, and AMP1 to start the normal amplifier operation.

After four write cycles are sent, the data in Register 0x140 to Register 0x145 are correctly loaded for use in operation.

[Table 17](#) is the basic sequence to start ADL6331 in normal operation. After the sequence is complete, the registers are set to the default configuration. It is recommended to enable AMP2, DSA, and AMP1 (in Register 0x101) in the last SPI cycle (Step 6) to avoid any unexpected output signals from the ADL6331 when the ENP pin is set to high combined with the 3.3 V supply.

Table 17. Example 1: SPI Command Writes

Address	Write Data	Notes
0x000	0x81	Software reset
0x000	0x18	1st Cycle: Configure 4-wire SPI mode
0x00A	0x01	2nd Cycle: Scratch pad writing. Any data is fine.
0x00A	0x02	3rd Cycle: Scratch pad writing. Any data is fine.
0x00A	0x03	4th Cycle: Scratch pad writing. Any data is fine.
0x101	0x07	The data in Register 0x140 to Register 0x145 are correctly loaded to use for operation. Enable AMP2, DSA, and AMP1 functions to start operations. Default register values are used for RF performance.

¹ Register 0x00A is named Scratch Page and is a read and write register for SPI communication testing that does not affect performance in the ADL6331.

BASIC CONNECTIONS

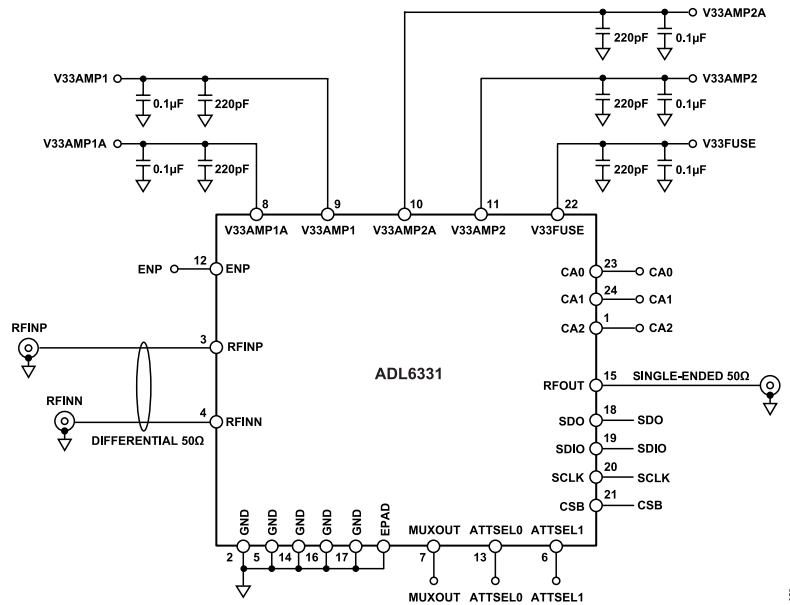

Figure 95. Basic Connections

Table 18. Basic Connections

Functional Blocks	Pin No.	Mnemonic	Description	Basic Connection
Chip Address Selection	1, 23, 24	CA2, CA1, CA0	SPI chip address selects	Chip address selection.
Ground	2, 5, 14, 16, 17	GND	Ground	Connect the GND pins to the ground of the PCB.
RF Input	3, 4	RFINP, RFINN	RF differential input	50 Ω differential input. AC-coupled is always recommended.
Preprogrammed Mode	6, 13	ATTSEL1, ATTSEL0	Preprogrammed mode selection	
MUXOUT	7	MUXOUT	Analog voltage output from the temperature sensor	Voltage measurement pin for reading chip temperature. Leave as no connect when not in use.
3.3 V	8 to 11	V33AMP1A, V33AMP1, V33AMP2A, V33AMP2	Amplifier, analog supply voltage	Decouple Pin 8 to Pin 11 via 220 pF, 0.1 μF capacitors to ground. Ensure that the decoupling capacitors are located close to the pins.
Device Enable	12	ENP	Active-high for normal operation	Decouple Pin 22 via 220 pF, 0.1 μF capacitors to ground. Ensure that the decoupling capacitors are located close to the pin.
RF Output	15	RFOUT	RF single-ended output	50 Ω single-ended output. AC-coupled is always recommended.
Serial Port	18	SDO	SPI data input	1.8 V to 3.3 V tolerant logic levels.
	19	SDIO	SPI data input and output	1.8 V to 3.3 V tolerant logic levels.
	20	SCLK	SPI clock	1.8 V to 3.3 V tolerant logic levels.
	21	CSB	Active-low chip select	1.8 V to 3.3 V tolerant logic levels.
3.3 V	22	V33FUSE	Digital, DSA, and other bias voltage	
EPAD	Exposed pad	Exposed pad	Exposed pad	Exposed Pad. The exposed pad must be connected to ground for electrical and thermal purposes.

APPLICATIONS INFORMATION

CURRENT CONSUMPTION OPTIMIZATION

When the MSB in Register 0x104, Register 0x105, and Register 0x106 for AMP1 and Register 0x110, Register 0x111, and Register 0x112 for AMP2 are set to 0, these six registers are tunable by the user. If lesser current consumption is needed, the settings of both AMP1_IGREF in Register 0x104 and AMP2_IGREF in Register 0x110 can be reduced according to the readback value of factory trimmed IGREF in Register 0x140 and Register 0x143 for AMP1 and AMP2, respectively. See Figure 96 and Figure 97. As a result of reducing AMP1_IGREF and AMP2_IGREF, the OIP3 performance degrades as shown in Figure 98 and Figure 99.

It is not recommended to increase the IGREF settings greater than the readback value for AMP1 and AMP2 and doing so could impact the long term reliability of the part.

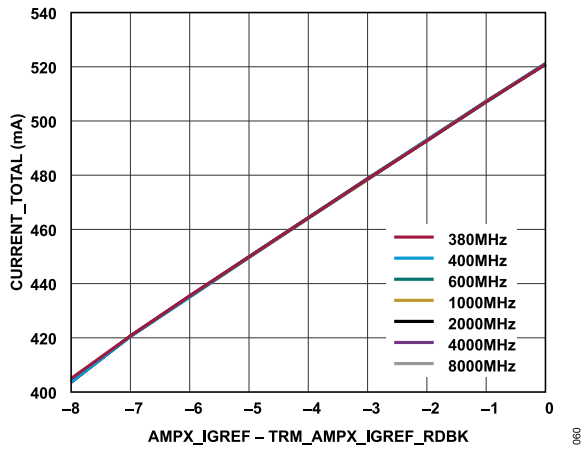

Figure 96. Total Current vs. IGREF Settings for Various Frequencies (ADL6331-A)

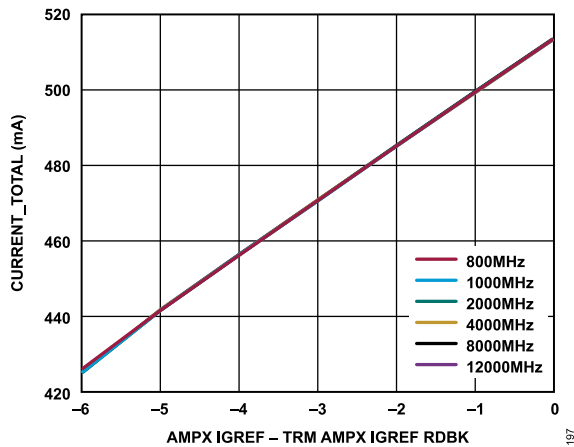

Figure 97. Total Current vs. IGREF Settings for Various Frequencies (ADL6331-B)

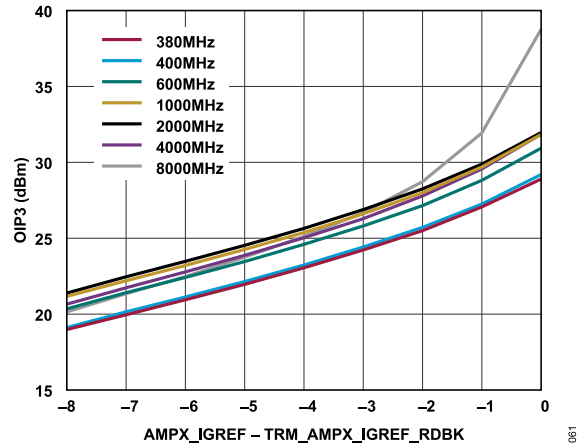

Figure 98. OIP3 vs. IGREF Settings for Various Frequencies (ADL6331-A)

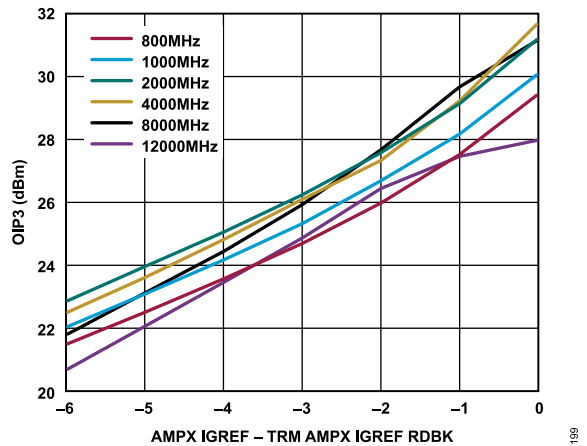

Figure 99. OIP3 vs. IGREF Settings for Various Frequencies (ADL6331-B)

AC COUPLING

The ESD clamps are located immediately following the input ports and prior to the output port (see Figure 100). When a DC voltage greater than or equal to 1.0 V is applied as common mode, there is a risk of latching the silicon controlled rectifier (SCR) clamps in the ESD protection block with a single spike. Even with a DC voltage less than 1 V, intermodulation performance of the part may be degraded. An external DC block capacitor for AC coupling is always recommended.

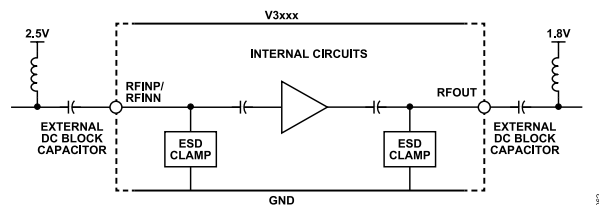

Figure 100. Simplified RF Input and Output Port Structure

REGISTER SUMMARY

Table 19. Register Summary

Reg	Name	Bits	Bit 7	Bit 6	Bit 5	Bit 4	Bit 3	Bit 2	Bit 1	Bit 0	Reset	RW	
0x000	ADI_SPI_CONF IG	[7:0]	SOFTRESE T_	LSB_FIRST _	ENDIAN_	SDOACTIV E_	SDOACTIV E	ENDIAN	LSB_FIRST	SOFTRESE T	0x00	R/W	
0x001	REG_0X0001	[7:0]	SINGLE_IN STRUCTIO N	CSB_STALL	PRIMARY_ SUBORDIN ATE_RB	RESERVED		SOFT_RESET		PRIMARY_ SUBORDIN ATE_TRAN SFER	0x00	R/W	
0x003	CHIPTYPE	[7:0]	CHIPTYPE									0x00	R
0x004	PRODUCT_ID_ L	[7:0]	PRODUCT_ID[7:0]									0x00	R
0x005	PRODUCT_ID_ H	[7:0]	PRODUCT_ID[15:8]									0x00	R
0x00A	SCRATCHPAD	[7:0]	SCRATCHPAD									0x00	R/W
0x00B	SPI_REV	[7:0]	SPI_REV									0x00	R
0x010	VARIANT_FEOL	[7:0]	FEOL				VARIANT				0x00	R	
0x011	BEOL_SIF	[7:0]	SIF				BEOL				0x00	R	
0x012	SPARE_0012	[7:0]	SPARE_0012									0x00	R
0x013	SPARE_0013	[7:0]	SPARE_0013									0x00	R
0x100	SIG_PATH0_0	[7:0]	RESERVED			AMUX_BG_ EN	RESERVED			LDO18_EN	0x11	R/W	
0x101	SIG_PATH1_0	[7:0]	RESERVED				AMP2_EN	DSA_EN	AMP1_EN	0x00	R/W		
0x102	SIG_PATH2_0	[7:0]	RESERVED				SIGCHAIN_ BYPASS	SEL_IBIAS GEN_BG	RESERVED	0x00	R/W		
0x103	SIG_PATH0_1	[7:0]	RESERVED			AMP1_MON _EN	RESERVED	AMP1_IM3_ EN	AMP1_LP_ MODE	0x06	R/W		
0x104	SIG_PATH1_1	[7:0]	NVM_TRM_ AMP1_IGRE F	RESERVED			AMP1_IGREF			0x89	R/W		
0x105	SIG_PATH2_1	[7:0]	NVM_TRM_ AMP1_IDRE F_Z	RESERVED	AMP1_IDREF_Z					0xAA	R/W		
0x106	SIG_PATH3_1	[7:0]	NVM_TRM_ AMP1_IDRE F_P	RESERVED			AMP1_IDREF_P			0x83	R/W		
0x109	SIG_PATH6_1	[7:0]	SPARE_010B				AMP1_IM3_CAP			0x07	R/W		
0x10A	SIG_PATH0_2	[7:0]	AMP2_BY_P ASS0	AMP1_BY_P ASS0	DSA_ATTNO					0xD8	R/W		
0x10B	SIG_PATH1_2	[7:0]	AMP2_BY_P ASS1	AMP1_BY_P ASS1	DSA_ATTNO1					0x10	R/W		
0x10C	SIG_PATH2_2	[7:0]	AMP2_BY_P ASS2	AMP1_BY_P ASS2	DSA_ATTNO2					0x08	R/W		
0x10D	SIG_PATH3_2	[7:0]	AMP2_BY_P ASS3	AMP1_BY_P ASS3	DSA_ATTNO3					0x00	R/W		
0x10F	SIG_PATH0_3	[7:0]	RESERVED			AMP2_MON _EN	AMP2_CRO SS_EN	AMP2_IM3_ EN	AMP2_LP_ MODE	0x06	R/W		
0x110	SIG_PATH1_3	[7:0]	NVM_TRM_ AMP2_IGRE F	RESERVED			AMP2_IGREF			0x89	R/W		
0x111	SIG_PATH2_3	[7:0]	NVM_TRM_ AMP2_IDRE F_Z	RESERVED	AMP2_IDREF_Z					0xAA	R/W		

REGISTER SUMMARY

Table 19. Register Summary (Continued)

Reg	Name	Bits	Bit 7	Bit 6	Bit 5	Bit 4	Bit 3	Bit 2	Bit 1	Bit 0	Reset	RW
0x112	SIG_PATH3_3	[7:0]	NVM_TRM_AMP2_IDREF_P	RESERVED			AMP2_IDREF_P				0x83	R/W
0x113	SIG_PATH4_3	[7:0]	RESERVED		AMP2_CROSS_Z						0x2A	R/W
0x114	SIG_PATH5_3	[7:0]	RESERVED				AMP2_CROSS_P			0x03	R/W	
0x115	SIG_PATH6_3	[7:0]	SPARE_011B				AMP2_IM3_CAP			0x07	R/W	
0x120	AMUX_SEL	[7:0]	RESERVED	AMUX_3_SEL			AMUX_2_SEL	AMUX_1_SEL			0x20	R/W
0x121	MULTI_FUNC_CTRL_0111	[7:0]	RESERVED			SPI_1P8_3P3_CTRL	RESERVED			0x00	R/W	
0x140	FUSE_READBACK_0	[7:0]	RESERVED				TRM_AMP1_IGREF_RDBK			0x00	R	
0x141	FUSE_READBACK_1	[7:0]	RESERVED		TRM_AMP1_IDREF_Z_RDBK						0x00	R
0x142	FUSE_READBACK_2	[7:0]	RESERVED				TRM_AMP1_IDREF_P_RDBK			0x00	R	
0x143	FUSE_READBACK_3	[7:0]	RESERVED				TRM_AMP2_IGREF_RDBK			0x00	R	
0x144	FUSE_READBACK_4	[7:0]	RESERVED		TRM_AMP2_IDREF_Z_RDBK						0x00	R
0x145	FUSE_READBACK_5	[7:0]	RESERVED				TRM_AMP2_IDREF_P_RDBK			0x00	R	
0x146	GENERIC_READBACK_0	[7:0]	RESERVED		AMP1_CROSS_Z_RDBK						0x00	R
0x147	GENERIC_READBACK_1	[7:0]	RESERVED				AMP1_CROSS_P_RDBK			0x00	R	
0x148	GENERIC_READBACK_2	[7:0]	RESERVED		AMP2_CROSS_Z_RDBK						0x00	R
0x149	GENERIC_READBACK_3	[7:0]	RESERVED				AMP2_CROSS_P_RDBK			0x00	R	
0x14A	GENERIC_READBACK_4	[7:0]	AMP2_BYPASS_RDBK	AMP1_BYPASS_RDBK	DSA_ATT_N_RDBK						0x00	R

REGISTER DETAILS

Address: 0x000, Reset: 0x00, Name: ADI_SPI_CONFIG

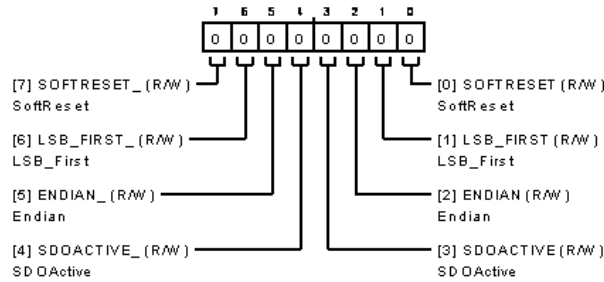

Table 20. Bit Descriptions for ADI_SPI_CONFIG

Bits	Bit Name	Description	Reset	Access
7	SOFTRESET_	SoftReset. 0: Reset Not Asserted. 1: Reset Asserted.	0x0	R/W
6	LSB_FIRST_	LSB_First. 0: MSB First. 1: LSB First.	0x0	R/W
5	ENDIAN_	Endian. 0: Address Descending. 1: Address Ascending.	0x0	R/W
4	SDOACTIVE_	SDOActive. 0: SDO Inactive (3-wire SPI Mode). 1: SDO Active (4-wire SPI Mode).	0x0	R/W
3	SDOACTIVE	SDOActive. 0: SDO Inactive (3-wire SPI Mode). 1: SDO Active (4-wire SPI Mode).	0x0	R/W
2	ENDIAN	Endian. 0: Address Descending. 1: Address Ascending.	0x0	R/W
1	LSB_FIRST	LSB_First. 0: MSB First. 1: LSB First.	0x0	R/W
0	SOFTRESET	SoftReset. 0: Reset Not Asserted. 1: Reset Asserted.	0x0	R/W

Address: 0x001, Reset: 0x00, Name: REG_0X0001

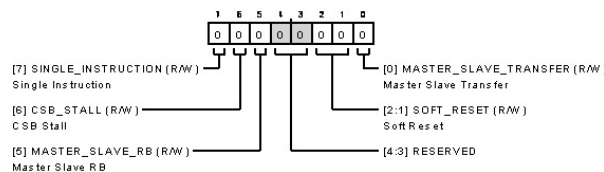

Table 21. Bit Descriptions for REG_0X0001

Bits	Bit Name	Description	Reset	Access
7	SINGLE_INSTRUCTION	Single Instruction.	0x0	R/W
6	CSB_STALL	CSB Stall.	0x0	R/W
5	PRIMARY_SUBORDINATE_RB	Primary Subordinate RB.	0x0	R/W

REGISTER DETAILS

Table 21. Bit Descriptions for REG_0X0001 (Continued)

Bits	Bit Name	Description	Reset	Access
[4:3]	RESERVED	Reserved.	0x0	R
[2:1]	SOFT_RESET	Soft Reset.	0x0	R/W
0	PRIMARY_SUBORDINATE_TRANSFER	Primary Subordinate Transfer.	0x0	R/W

Address: 0x003, Reset: 0x00, Name: CHIPTYPE

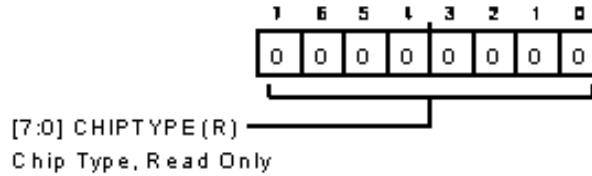

Table 22. Bit Descriptions for CHIPTYPE

Bits	Bit Name	Description	Reset	Access
[7:0]	CHIPTYPE	Chip Type, Read Only.	0x0	R

Address: 0x004, Reset: 0x00, Name: PRODUCT_ID_L

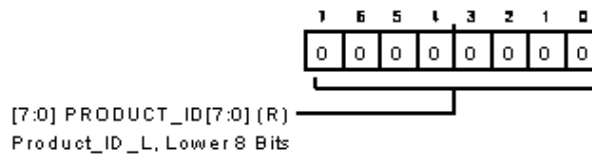

Table 23. Bit Descriptions for PRODUCT_ID_L

Bits	Bit Name	Description	Reset	Access
[7:0]	PRODUCT_ID[7:0]	Product_ID_L, Lower 8 Bits.	0x0	R

Address: 0x005, Reset: 0x00, Name: PRODUCT_ID_H

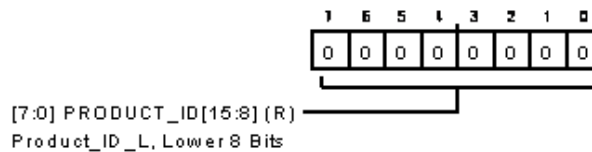

Table 24. Bit Descriptions for PRODUCT_ID_H

Bits	Bit Name	Description	Reset	Access
[7:0]	PRODUCT_ID[15:8]	Product_ID_L, Lower 8 Bits.	0x0	R

Address: 0x00A, Reset: 0x00, Name: SCRATCHPAD

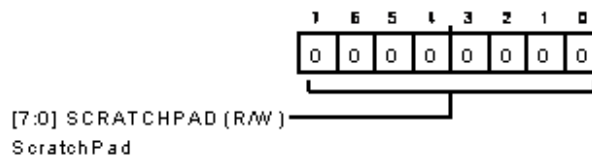

Table 25. Bit Descriptions for SCRATCHPAD

Bits	Bit Name	Description	Reset	Access
[7:0]	SCRATCHPAD	ScratchPad.	0x0	R/W

REGISTER DETAILS

Address: 0x00B, Reset: 0x00, Name: SPI_REV

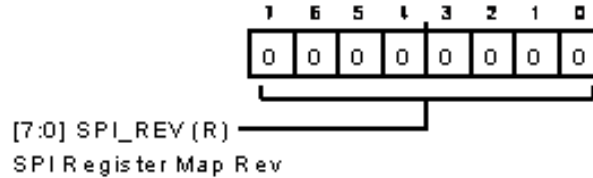

Table 26. Bit Descriptions for SPI_REV

Bits	Bit Name	Description	Reset	Access
[7:0]	SPI_REV	SPI Register Map Rev.	0x0	R

Address: 0x010, Reset: 0x00, Name: VARIANT_FEOL

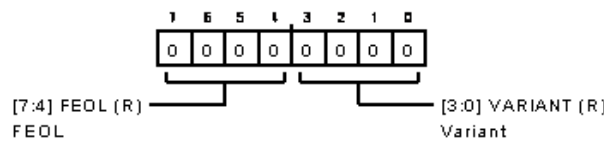

Table 27. Bit Descriptions for VARIANT_FEOL

Bits	Bit Name	Description	Reset	Access
[7:4]	FEOL	FEOL.	0x0	R
[3:0]	VARIANT	Variant.	0x0	R

Address: 0x011, Reset: 0x00, Name: BEOL_SIF

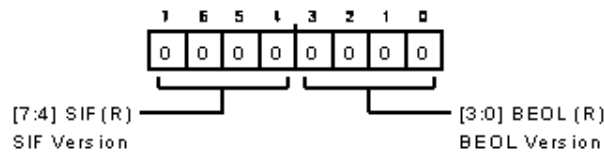

Table 28. Bit Descriptions for BEOL_SIF

Bits	Bit Name	Description	Reset	Access
[7:4]	SIF	SIF Version.	0x0	R
[3:0]	BEOL	BEOL Version.	0x0	R

Address: 0x012, Reset: 0x00, Name: SPARE_0012

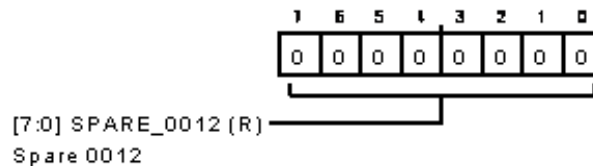

Table 29. Bit Descriptions for SPARE_0012

Bits	Bit Name	Description	Reset	Access
[7:0]	SPARE_0012	Spare 0012.	0x0	R

Address: 0x013, Reset: 0x00, Name: SPARE_0013

REGISTER DETAILS

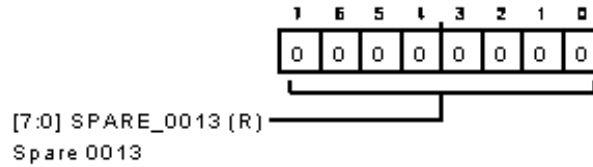

Table 30. Bit Descriptions for SPARE_0013

Bits	Bit Name	Description	Reset	Access
[7:0]	SPARE_0013	Spare 0013.	0x0	R

Address: 0x100, Reset: 0x11, Name: SIG_PATH0_0

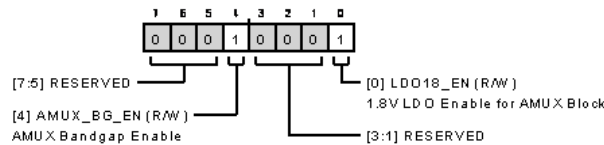

Table 31. Bit Descriptions for SIG_PATH0_0

Bits	Bit Name	Description	Reset	Access
[7:5]	RESERVED	Reserved.	0x0	R
4	AMUX_BG_EN	AMUX Bandgap Enable. 0: Disable AMUX Bandgap. 1: Enable AMUX Bandgap.	0x1	R/W
[3:1]	RESERVED	Reserved.	0x0	R/W
0	LDO18_EN	1.8V LDO Enable for AMUX Block. 0: Disable. 1: Enable.	0x1	R/W

Address: 0x101, Reset: 0x00, Name: SIG_PATH1_0

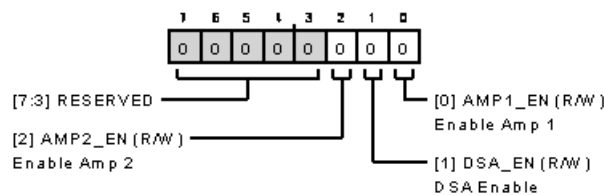

Table 32. Bit Descriptions for SIG_PATH1_0

Bits	Bit Name	Description	Reset	Access
[7:3]	RESERVED	Reserved.	0x0	R
2	AMP2_EN	Enable Amp 2. 0: Disable. 1: Enable.	0x0	R/W
1	DSA_EN	DSA Enable. 0: Disable. 1: Enable.	0x0	R/W
0	AMP1_EN	Enable Amp 1. 0: Disable. 1: Enable.	0x0	R/W

Address: 0x102, Reset: 0x00, Name: SIG_PATH2_0

REGISTER DETAILS

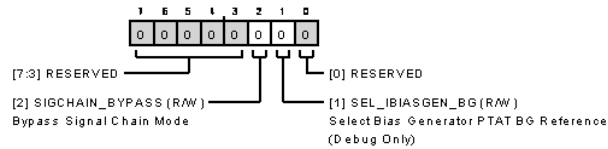

Table 33. Bit Descriptions for SIG_PATH2_0

Bits	Bit Name	Description	Reset	Access
[7:3]	RESERVED	Reserved.	0x0	R
2	SIGCHAIN_BYPASS	Bypass Signal Chain Mode. 0: Based on Individual Amp Bypass Setting. 1: Bypass Both Amps.	0x0	R/W
1	SEL_IBIASGEN_BG	Select Bias Generator PTAT BG Reference (Debug Only). 0: Use Dedicated PTAT Generator (Default). 1: Use Bandgap Based PTAT Generator.	0x0	R/W
0	RESERVED	Reserved.	0x0	R/W

Address: 0x103, Reset: 0x06, Name: SIG_PATH0_1

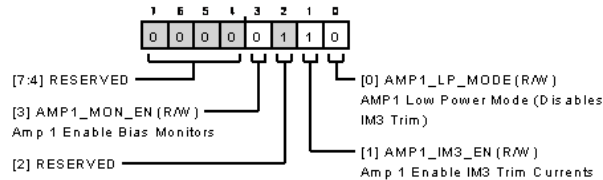

Table 34. Bit Descriptions for SIG_PATH0_1

Bits	Bit Name	Description	Reset	Access
[7:4]	RESERVED	Reserved.	0x0	R
3	AMP1_MON_EN	Amp 1 Enable Bias Monitors. 0: Disable Bias Monitoring. 1: Enable Bias Monitoring (Debug Only).	0x0	R/W
2	RESERVED	Reserved.	0x1	R/W
1	AMP1_IM3_EN	Amp 1 Enable IM3 Trim Currents. 0: Disable IM3 Trim Currents. 1: Enable IM3 Trim Currents.	0x1	R/W
0	AMP1_LP_MODE	AMP1 Low Power Mode (Disables IM3 Trim). 0: Disable. Use Default Bias. 1: Enable Low Bias.	0x0	R/W

Address: 0x104, Reset: 0x89, Name: SIG_PATH1_1

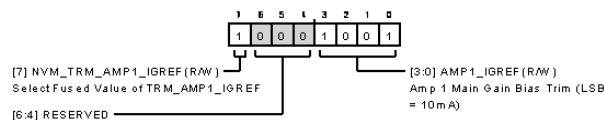

Table 35. Bit Descriptions for SIG_PATH1_1

Bits	Bit Name	Description	Reset	Access
7	NVM_TRM_AMP1_IGREF	Select Fused Value of TRM_AMP1_IGREF.	0x1	R/W
[6:4]	RESERVED	Reserved.	0x0	R
[3:0]	AMP1_IGREF	Amp 1 Main Gain Bias Trim (LSB = 10mA).	0x9	R/W

REGISTER DETAILS

Address: 0x105, Reset: 0xAA, Name: SIG_PATH2_1

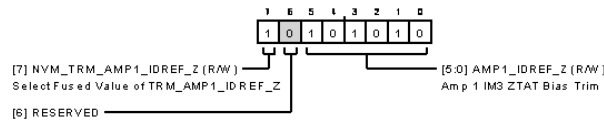

Table 36. Bit Descriptions for SIG_PATH2_1

Bits	Bit Name	Description	Reset	Access
7	NVM_TRM_AMP1_IDREF_Z	Select Fused Value of TRM_AMP1_IDREF_Z.	0x1	R/W
6	RESERVED	Reserved.	0x0	R
[5:0]	AMP1_IDREF_Z	Amp 1 IM3 ZTAT Bias Trim.	0x2A	R/W

Address: 0x106, Reset: 0x83, Name: SIG_PATH3_1

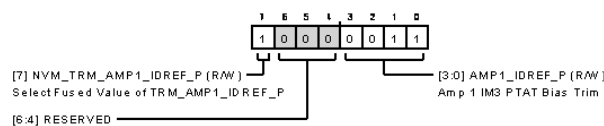

Table 37. Bit Descriptions for SIG_PATH3_1

Bits	Bit Name	Description	Reset	Access
7	NVM_TRM_AMP1_IDREF_P	Select Fused Value of TRM_AMP1_IDREF_P.	0x1	R/W
[6:4]	RESERVED	Reserved.	0x0	R
[3:0]	AMP1_IDREF_P	Amp 1 IM3 PTAT Bias Trim.	0x3	R/W

Address: 0x109, Reset: 0x07, Name: SIG_PATH6_1

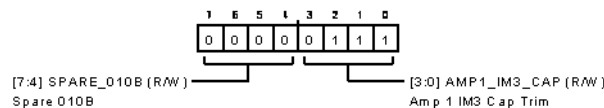

Table 38. Bit Descriptions for SIG_PATH6_1

Bits	Bit Name	Description	Reset	Access
[7:4]	SPARE_010B	Spare 010B.	0x0	R/W
[3:0]	AMP1_IM3_CAP	Amp 1 IM3 Cap Trim.	0x7	R/W

Address: 0x10A, Reset: 0xD8, Name: SIG_PATH0_2

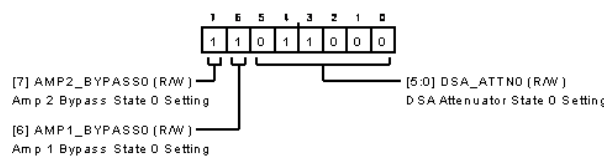

Table 39. Bit Descriptions for SIG_PATH0_2

Bits	Bit Name	Description	Reset	Access
7	AMP2_BYPASS0	Amp 2 Bypass State 0 Setting. 0: Fixed Gain Mode. 1: Bypass Mode Enable.	0x1	R/W
6	AMP1_BYPASS0	Amp 1 Bypass State 0 Setting. 0: Fixed Gain Mode. 1: Bypass Mode Enable.	0x1	R/W

REGISTER DETAILS

Table 39. Bit Descriptions for SIG_PATH0_2 (Continued)

Bits	Bit Name	Description	Reset	Access
[5:0]	DSA_ATTNO	DSA Attenuator State 0 Setting. 00000: 0dB. 00001: 1dB. 00010: 2dB. 00011: 3dB. 00100: 4dB. 00101: 5dB. 00110: 6dB. 00111: 7dB. 01000: 8dB. 01001: 9dB. 01010: 10dB. 01011: 11dB. 01100: 12dB. 01101: 13dB. 01110: 14dB. 01111: 15dB. 10000: 16dB. 10001: 17dB. 10010: 18dB. 10011: 19dB. 10100: 20dB. 10101: 21dB. 10110: 22dB. 10111: 23dB. 11000: 24dB.	0x18	R/W

Address: 0x10B, Reset: 0x10, Name: SIG_PATH1_2

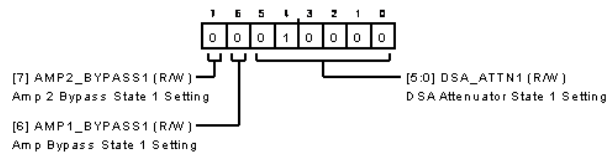

Table 40. Bit Descriptions for SIG_PATH1_2

Bits	Bit Name	Description	Reset	Access
7	AMP2_BYPASS1	Amp 2 Bypass State 1 Setting. 0: Fixed Gain Mode. 1: Bypass Mode Enable.	0x0	R/W
6	AMP1_BYPASS1	Amp Bypass State 1 Setting. 0: Fixed Gain Mode. 1: Bypass Mode Enable.	0x0	R/W
[5:0]	DSA_ATT1	DSA Attenuator State 1 Setting. 00000: 0dB. 00001: 1dB. 00010: 2dB. 00011: 3dB. 00100: 4dB.	0x10	R/W

REGISTER DETAILS

Table 40. Bit Descriptions for SIG_PATH1_2 (Continued)

Bits	Bit Name	Description	Reset	Access
		00101: 5dB.		
		00110: 6dB.		
		00111: 7dB.		
		01000: 8dB.		
		01001: 9dB.		
		01010: 10dB.		
		01011: 11dB.		
		01100: 12dB.		
		01101: 13dB.		
		01110: 14dB.		
		01111: 15dB.		
		10000: 16dB.		
		10001: 17dB.		
		10010: 18dB.		
		10011: 19dB.		
		10100: 20dB.		
		10101: 21dB.		
		10110: 22dB.		
		10111: 23dB.		
		11000: 24dB.		

Address: 0x10C, Reset: 0x08, Name: SIG_PATH2_2

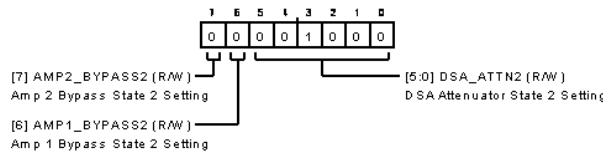

Table 41. Bit Descriptions for SIG_PATH2_2

Bits	Bit Name	Description	Reset	Access
7	AMP2_BYPASS2	Amp 2 Bypass State 2 Setting. 0: Fixed Gain Mode. 1: Bypass Mode Enable.	0x0	R/W
6	AMP1_BYPASS2	Amp 1 Bypass State 2 Setting. 0: Fixed Gain Mode. 1: Bypass Mode Enable.	0x0	R/W
[5:0]	DSA_ATT2	DSA Attenuator State 2 Setting. 00000: 0dB. 00001: 1dB. 00010: 2dB. 00011: 3dB. 00100: 4dB. 00101: 5dB. 00110: 6dB. 00111: 7dB. 01000: 8dB. 01001: 9dB. 01010: 10dB.	0x8	R/W

REGISTER DETAILS

Table 41. Bit Descriptions for SIG_PATH2_2 (Continued)

Bits	Bit Name	Description	Reset	Access
		01011: 11dB.		
		01100: 12dB.		
		01101: 13dB.		
		01110: 14dB.		
		01111: 15dB.		
		10000: 16dB.		
		10001: 17dB.		
		10010: 18dB.		
		10011: 19dB.		
		10100: 20dB.		
		10101: 21dB.		
		10110: 22dB.		
		10111: 23dB.		
		11000: 24dB.		

Address: 0x10D, Reset: 0x00, Name: SIG_PATH3_2

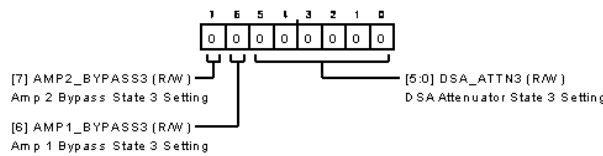

Table 42. Bit Descriptions for SIG_PATH3_2

Bits	Bit Name	Description	Reset	Access
7	AMP2_BYPASS3	Amp 2 Bypass State 3 Setting. 0: Fixed Gain Mode. 1: Bypass Mode Enable.	0x0	R/W
6	AMP1_BYPASS3	Amp 1 Bypass State 3 Setting. 0: Fixed Gain Mode. 1: Bypass Mode Enable.	0x0	R/W
[5:0]	DSA_ATT3	DSA Attenuator State 3 Setting. 00000: 0dB. 00001: 1dB. 00010: 2dB. 00011: 3dB. 00100: 4dB. 00101: 5dB. 00110: 6dB. 00111: 7dB. 01000: 8dB. 01001: 9dB. 01010: 10dB. 01011: 11dB. 01100: 12dB. 01101: 13dB. 01110: 14dB. 01111: 15dB. 10000: 16dB.	0x0	R/W

REGISTER DETAILS

Table 42. Bit Descriptions for SIG_PATH3_2 (Continued)

Bits	Bit Name	Description	Reset	Access
		10001: 17dB. 10010: 18dB. 10011: 19dB. 10100: 20dB. 10101: 21dB. 10110: 22dB. 10111: 23dB. 11000: 24dB.		

Address: 0x10F, Reset: 0x06, Name: SIG_PATH0_3

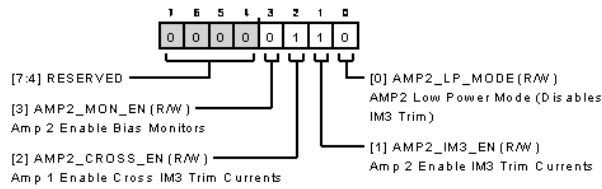

Table 43. Bit Descriptions for SIG_PATH0_3

Bits	Bit Name	Description	Reset	Access
[7:4]	RESERVED	Reserved.	0x0	R
3	AMP2_MON_EN	Amp 2 Enable Bias Monitors. 0: Disable Bias Monitoring. 1: Enable Bias Monitoring (Debug Only).	0x0	R/W
2	AMP2_CROSS_EN	Amp 1 Enable Cross IM3 Trim Currents. 0: Disable Cross-Coupled Stage IM3 Trim. 1: Enable Cross-Coupled Stage IM3 Trim.	0x1	R/W
1	AMP2_IM3_EN	Amp 2 Enable IM3 Trim Currents. 0: Disable IM3 Trim Currents. 1: Enable IM3 Trim Currents.	0x1	R/W
0	AMP2_LP_MODE	AMP2 Low Power Mode (Disables IM3 Trim). 0: Disable. Use Default Bias. 1: Enable Low Bias.	0x0	R/W

Address: 0x110, Reset: 0x89, Name: SIG_PATH1_3

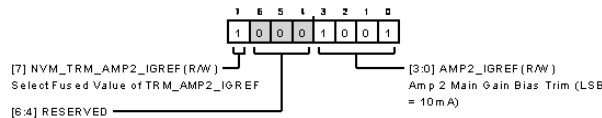

Table 44. Bit Descriptions for SIG_PATH1_3

Bits	Bit Name	Description	Reset	Access
7	NVM_TRM_AMP2_IGREF	Select Fused Value of TRM_AMP2_IGREF.	0x1	R/W
[6:4]	RESERVED	Reserved.	0x0	R
[3:0]	AMP2_IGREF	Amp 2 Main Gain Bias Trim (LSB = 10mA).	0x9	R/W

Address: 0x111, Reset: 0xAA, Name: SIG_PATH2_3

REGISTER DETAILS

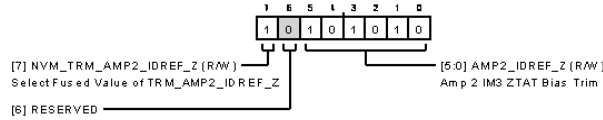

Table 45. Bit Descriptions for SIG_PATH2_3

Bits	Bit Name	Description	Reset	Access
7	NVM_TRM_AMP2_IDREF_Z	Select Fused Value of TRM_AMP2_IDREF_Z.	0x1	R/W
6	RESERVED	Reserved.	0x0	R
[5:0]	AMP2_IDREF_Z	Amp 2 IM3 ZTAT Bias Trim.	0x2A	R/W

Address: 0x112, Reset: 0x83, Name: SIG_PATH3_3

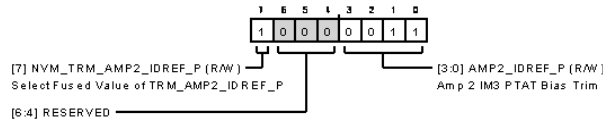

Table 46. Bit Descriptions for SIG_PATH3_3

Bits	Bit Name	Description	Reset	Access
7	NVM_TRM_AMP2_IDREF_P	Select Fused Value of TRM_AMP2_IDREF_P.	0x1	R/W
[6:4]	RESERVED	Reserved.	0x0	R
[3:0]	AMP2_IDREF_P	Amp 2 IM3 PTAT Bias Trim.	0x3	R/W

Address: 0x113, Reset: 0x2A, Name: SIG_PATH4_3

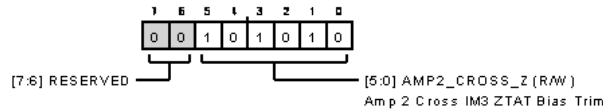

Table 47. Bit Descriptions for SIG_PATH4_3

Bits	Bit Name	Description	Reset	Access
[7:6]	RESERVED	Reserved.	0x0	R
[5:0]	AMP2_CROSS_Z	Amp 2 Cross IM3 ZTAT Bias Trim.	0x2A	R/W

Address: 0x114, Reset: 0x03, Name: SIG_PATH5_3

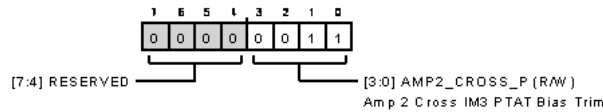
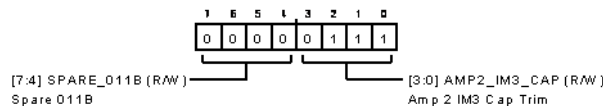

Table 48. Bit Descriptions for SIG_PATH5_3

Bits	Bit Name	Description	Reset	Access
[7:4]	RESERVED	Reserved.	0x0	R
[3:0]	AMP2_CROSS_P	Amp 2 Cross IM3 PTAT Bias Trim.	0x3	R/W

Address: 0x115, Reset: 0x07, Name: SIG_PATH6_3



REGISTER DETAILS

Table 49. Bit Descriptions for SIG_PATH6_3

Bits	Bit Name	Description	Reset	Access
[7:4]	SPARE_011B	Spare 011B.	0x0	R/W
[3:0]	AMP2_IM3_CAP	Amp 2 IM3 Cap Trim.	0x7	R/W

Address: 0x120, Reset: 0x20, Name: AMUX_SEL

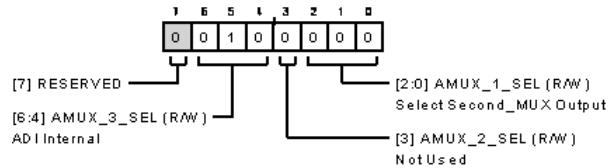

Table 50. Bit Descriptions for AMUX_SEL

Bits	Bit Name	Description	Reset	Access
7	RESERVED	Reserved.	0x0	R/W
[6:4]	AMUX_3_SEL	ADI Internal.	0x2	R/W
3	AMUX_2_SEL	Not Used.	0x0	R/W
[2:0]	AMUX_1_SEL	Select Second_MUX Output. 000: PTAT (Temperature Sensor).	0x0	R/W

Address: 0x121, Reset: 0x00, Name: MULTI_FUNC_CTRL_0111

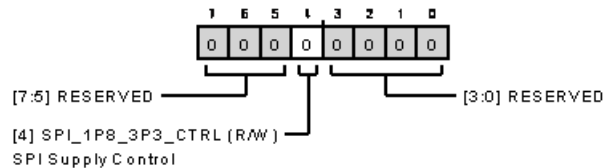

Table 51. Bit Descriptions for MULTI_FUNC_CTRL_0111

Bits	Bit Name	Description	Reset	Access
[7:5]	RESERVED	Reserved.	0x0	R
4	SPI_1P8_3P3_CTRL	SPI Supply Control. 0: 1.8V Read Back. 1: 3.3V Read Back.	0x0	R/W
[3:0]	RESERVED	Reserved.	0x0	R/W

Address: 0x140, Reset: 0x00, Name: FUSE_READBACK_0

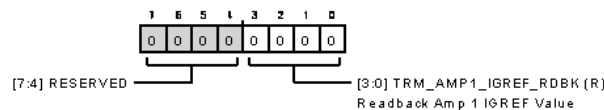

Table 52. Bit Descriptions for FUSE_READBACK_0

Bits	Bit Name	Description	Reset	Access
[7:4]	RESERVED	Reserved.	0x0	R
[3:0]	TRM_AMP1_IGREF_RDBK	Readback Amp 1 I GREF Value.	0x0	R

Address: 0x141, Reset: 0x00, Name: FUSE_READBACK_1

REGISTER DETAILS

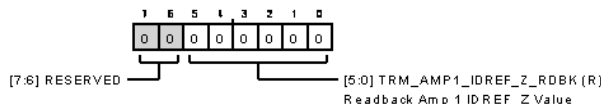

Table 53. Bit Descriptions for FUSE_READBACK_1

Bits	Bit Name	Description	Reset	Access
[7:6]	RESERVED	Reserved.	0x0	R
[5:0]	TRM_AMP1_IDREF_Z_RDBK	Readback Amp 1 IDREF_Z Value.	0x0	R

Address: 0x142, Reset: 0x00, Name: FUSE_READBACK_2

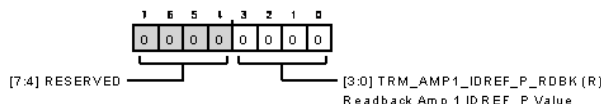

Table 54. Bit Descriptions for FUSE_READBACK_2

Bits	Bit Name	Description	Reset	Access
[7:4]	RESERVED	Reserved.	0x0	R
[3:0]	TRM_AMP1_IDREF_P_RDBK	Readback Amp 1 IDREF_P Value.	0x0	R

Address: 0x143, Reset: 0x00, Name: FUSE_READBACK_3

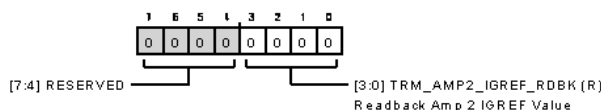

Table 55. Bit Descriptions for FUSE_READBACK_3

Bits	Bit Name	Description	Reset	Access
[7:4]	RESERVED	Reserved.	0x0	R
[3:0]	TRM_AMP2_IGREF_RDBK	Readback Amp 2 IGREF Value.	0x0	R

Address: 0x144, Reset: 0x00, Name: FUSE_READBACK_4

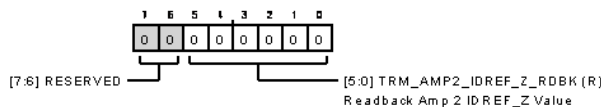

Table 56. Bit Descriptions for FUSE_READBACK_4

Bits	Bit Name	Description	Reset	Access
[7:6]	RESERVED	Reserved.	0x0	R
[5:0]	TRM_AMP2_IDREF_Z_RDBK	Readback Amp 2 IDREF_Z Value.	0x0	R

Address: 0x145, Reset: 0x00, Name: FUSE_READBACK_5

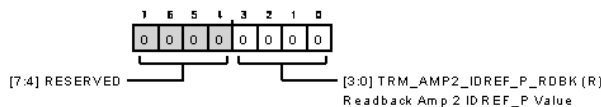

Table 57. Bit Descriptions for FUSE_READBACK_5

Bits	Bit Name	Description	Reset	Access
[7:4]	RESERVED	Reserved.	0x0	R

REGISTER DETAILS

Table 57. Bit Descriptions for FUSE_READBACK_5 (Continued)

Bits	Bit Name	Description	Reset	Access
[3:0]	TRM_AMP2_IDREF_P_RDBK	Readback Amp 2 IDREF_P Value.	0x0	R

Address: 0x146, Reset: 0x00, Name: GENERIC_READBACK_0

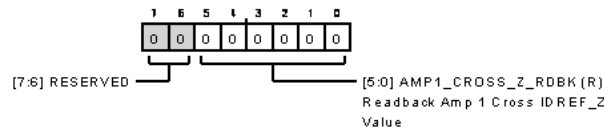

Table 58. Bit Descriptions for GENERIC_READBACK_0

Bits	Bit Name	Description	Reset	Access
[7:6]	RESERVED	Reserved.	0x0	R
[5:0]	AMP1_CROSS_Z_RDBK	Readback Amp 1 Cross IDREF_Z Value.	0x0	R

Address: 0x147, Reset: 0x00, Name: GENERIC_READBACK_1

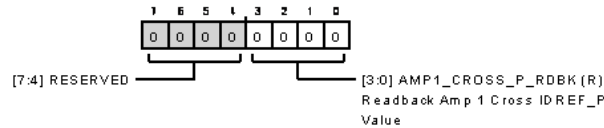

Table 59. Bit Descriptions for GENERIC_READBACK_1

Bits	Bit Name	Description	Reset	Access
[7:4]	RESERVED	Reserved.	0x0	R
[3:0]	AMP1_CROSS_P_RDBK	Readback Amp 1 Cross IDREF_P Value.	0x0	R

Address: 0x148, Reset: 0x00, Name: GENERIC_READBACK_2

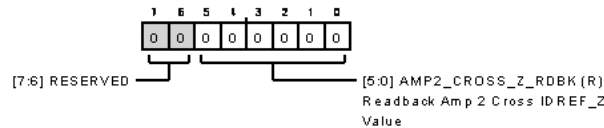

Table 60. Bit Descriptions for GENERIC_READBACK_2

Bits	Bit Name	Description	Reset	Access
[7:6]	RESERVED	Reserved.	0x0	R
[5:0]	AMP2_CROSS_Z_RDBK	Readback Amp 2 Cross IDREF_Z Value.	0x0	R

Address: 0x149, Reset: 0x00, Name: GENERIC_READBACK_3

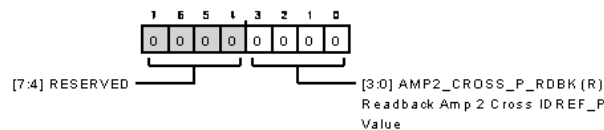
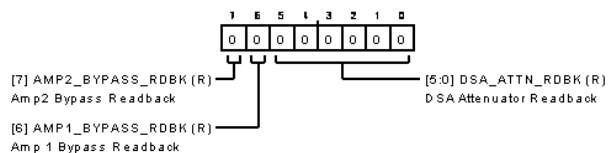

Table 61. Bit Descriptions for GENERIC_READBACK_3

Bits	Bit Name	Description	Reset	Access
[7:4]	RESERVED	Reserved.	0x0	R
[3:0]	AMP2_CROSS_P_RDBK	Readback Amp 2 Cross IDREF_P Value.	0x0	R

Address: 0x14A, Reset: 0x00, Name: GENERIC_READBACK_4

REGISTER DETAILS

Table 62. Bit Descriptions for *GENERIC_READBACK_4*

Bits	Bit Name	Description	Reset	Access
7	AMP2_BYPASS_RDBK	Amp2 Bypass Readback.	0x0	R
6	AMP1_BYPASS_RDBK	Amp 1 Bypass Readback.	0x0	R
[5:0]	DSA_ATT_N_RDBK	DSA Attenuator Readback.	0x0	R

OUTLINE DIMENSIONS

Package Drawing (Option)	Package Type	Package Description
CC-24-17	LGA	24-Terminal Land Grid Array

For the latest package outline information and land patterns (footprints), go to [Package Index](#).

ORDERING GUIDE

Model ¹	Temperature Range	Package Description	Packing Quantity	Package Option
ADL6331ACCZA	-40°C to +105°C	24-Lead LGA (4 mm × 4 mm × 0.76 mm w/ EP)	Cut Tape, 500	CC-24-17
ADL6331ACCZA-R7	-40°C to +105°C	24-Lead LGA (4 mm × 4 mm × 0.76 mm w/ EP)	Reel, 500	CC-24-17
ADL6331ACCZB	-40°C to +105°C	24-Lead LGA (4 mm × 4 mm × 0.76 mm w/ EP)	Cut Tape, 500	CC-24-17
ADL6331ACCZB-R7	-40°C to +105°C	24-Lead LGA (4 mm × 4 mm × 0.76 mm w/ EP)	Reel, 500	CC-24-17

¹ Z = RoHS Compliant Part.

EVALUATION BOARDS

Model ¹	Description
ADL6331-EVALZA	Version A (0.38 GHz to 8.0 GHz) Evaluation Board
ADL6331-EVALZB	Version B (1.0 GHz to 15.0 GHz) Evaluation Board

¹ Z = RoHS Compliant Part.

Looking for pricing, stock, or lifecycle information?

Click below to explore more details on WIN SOURCE:

 [View ADL6331ACCZB on WIN SOURCE](#)

 [Analog Devices Inc. Information](#)

Optimize Your Supply Chain with WIN SOURCE Solutions

-  Global Sourcing Solution
-  Obsolete Management
-  Cost Control Management
-  Shortage Management
-  Alternative Solution
-  Excess Inventory Management