

Product Overview

MMA041AA is a Gallium Arsenide (GaAs) monolithic microwave integrated circuit (MMIC) Pseudomorphic High-Electron Mobility Transistor (PHEMT) distributed amplifier die that operates between DC and 26 GHz. It is ideal for test instrumentation, defense, aerospace, and communications infrastructure applications. The amplifier provides a flat gain of 18.5 dB, 2 dB noise figure, and 22 dBm of output power at 1 dB gain compression, and 36 dBm output IP3. The MMA041AA amplifier features RF I/Os that are internally matched to 50Ω, which allows for easy integration into multi-chip modules (MCMs).

Key Features

- Broadband performance: DC to 26 GHz
- High gain: 18.5 dB
- Low noise figure: 2 dB
- High output IP3: +36 dBm
- High input power: +22 dBm
- Positive supply : +6V at 150 mA
- 50Ω matched input/output
- Die size: 3.0 mm × 1.35 mm × 0.1 mm

Functional Block Diagram

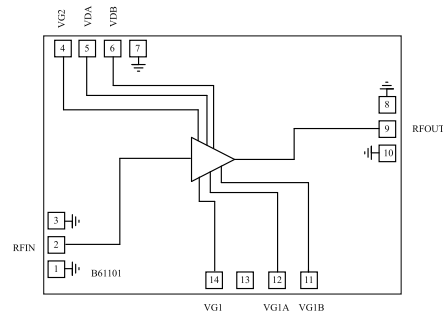

Applications

- Test and measurement instrumentation
- Electronic warfare (EW), electronic countermeasures (ECM), and electronic counter-countermeasures (ECCM)
- Military, A&D, space, SATCOM
- Telecom infrastructure
- Wideband microwave radios
- Microwave and millimeter-wave communication systems

Performance Overview

Parameter	Typ.	Units
Frequency range	DC – 26	GHz
Gain	18.5	dB
NF	2	dB
Output IP3	+36	dBm
P1dB	+22	dBm

Export Classification: EAR-99

Gain, NF, OIP3, and P1dB Performances

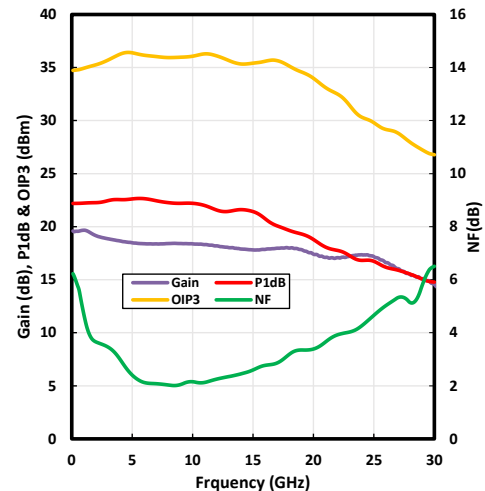

Table of Contents

Product Overview.....	1
1. Electrical Specifications.....	3
1.1. Typical Electrical Performance.....	3
1.2. Absolute Maximum Ratings.....	3
1.3. Typical Performance Curves.....	4
2. Die Specifications.....	14
3. Application Circuit.....	16
4. Ordering, Shipping, and Handling.....	18
4.1. Handling Recommendations.....	18
4.2. Ordering Information.....	18
4.3. Packing Information.....	18
5. Revision History.....	19
Microchip Information.....	20
The Microchip Website.....	20
Product Change Notification Service.....	20
Customer Support.....	20
Microchip Devices Code Protection Feature.....	20
Legal Notice.....	20
Trademarks.....	21
Quality Management System.....	22
Worldwide Sales and Service.....	23

1. Electrical Specifications

1.1 Typical Electrical Performance

Table 1-1. Typical Electrical Performance at 25 °C, $V_{DD} = 6V$, $I_{DD} = 150$ mA (unless otherwise specified)

Parameter	Frequency Range	Min	Typ.	Max	Units
Frequency range		DC		26	GHz
Gain	DC – 6 GHz	18	20		dB
	6 GHz – 12 GHz	17	18.5		
	12 GHz – 20 GHz	17	18		
	20 GHz – 26 GHz		17		
Gain flatness	4 GHz – 12 GHz		± 0.5		dB
	12 GHz – 20 GHz		± 0.25		
Noise figure	2 GHz – 6 GHz		2.2	3	dB
	6 GHz – 12 GHz		1.5	2	
	12 GHz – 20 GHz		2	3	
	20 GHz – 26 GHz		3.5		
P1dB	DC – 6 GHz	21.5	22		dBm
	6 GHz – 12 GHz	21	22		
	12 GHz – 20 GHz	18.5	20		
	20 GHz – 26 GHz		18		
P3dB	DC – 6 GHz		24		dBm
	6 GHz – 12 GHz		24		
	12 GHz – 20 GHz		23		
	20 GHz – 26 GHz		20		
OIP3	DC – 6 GHz		37		dBm
	6 GHz – 12 GHz		37		
	12 GHz – 20 GHz		36		
	20 GHz – 26 GHz		32		
Input return loss	DC – 6 GHz		17		dB
	6 GHz – 12 GHz		20		
	12 GHz – 20 GHz		20		
	20 GHz – 26 GHz		15		
Output return loss	DC – 6 GHz		17		dB
	6 GHz – 12 GHz		17		
	12 GHz – 20 GHz		16		
	20 GHz – 26 GHz		15		
V_{DD} (drain voltage supply)			6		V
I_{DD} (drain current)			150		mA
V_{GG} (gate voltage bias)			-0.4		V

1.2 Absolute Maximum Ratings

The following table shows the absolute maximum ratings of the MMA041AA device at 25 °C, unless otherwise specified. Exceeding one or any of the maximum ratings potentially could cause damage or latent defects to the device.

Table 1-2. Absolute Maximum Ratings

Parameter	Rating
Drain bias voltage (V_D)	+8V
First gate bias voltage (V_{G1})	-2V to +0.5V
RF input power (P_{in})	22 dBm
DC power dissipation ($T = +85\text{ }^\circ\text{C}$)	2.4W
Channel temperature	150 $^\circ\text{C}$
Thermal resistance	18 $^\circ\text{C/W}$
Operating temperature	-55 $^\circ\text{C}$ to +85 $^\circ\text{C}$
Storage temperature	-65 $^\circ\text{C}$ to +150 $^\circ\text{C}$



ESD Sensitive Device

1.3 Typical Performance Curves

1.3.1 Typical Performances vs. Temperature

The following graphs show the typical performance curves of the MMA041AA device at specific bias conditions. All measurements were performed using the test circuit shown in Figure 3-2.

Figure 1-1. Gain vs. Temperature at 5V/100 mA

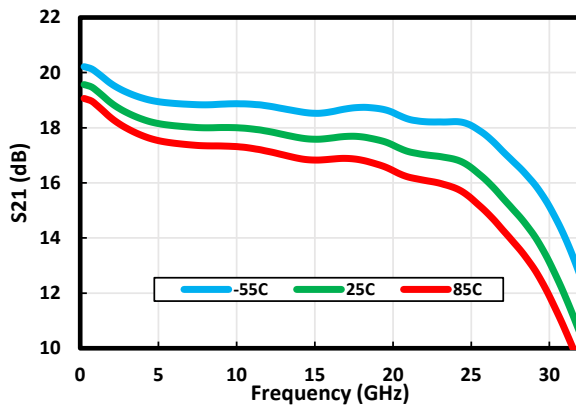

Figure 1-2. Gain vs. Temperature at 6V/150 mA

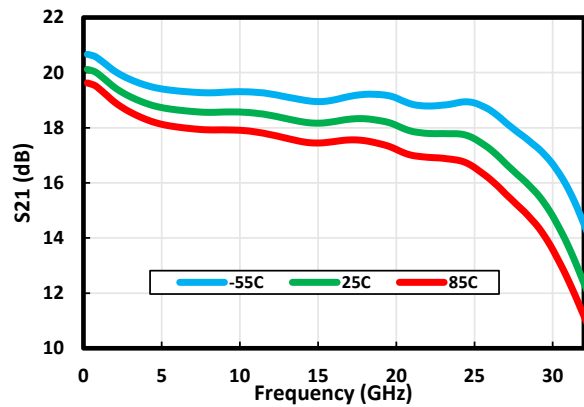

Figure 1-3. Gain vs. Temperature at 7V/180 mA

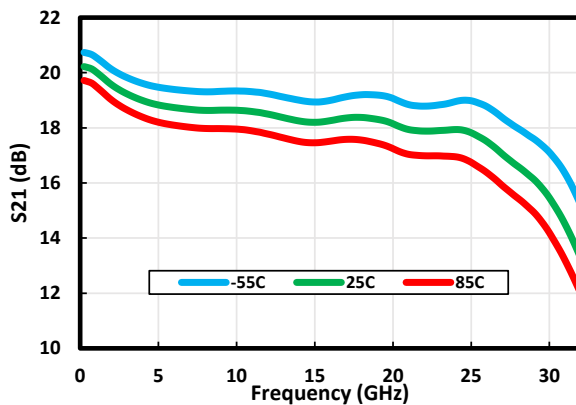

Figure 1-4. S11 vs. Temperature at 5V/100 mA

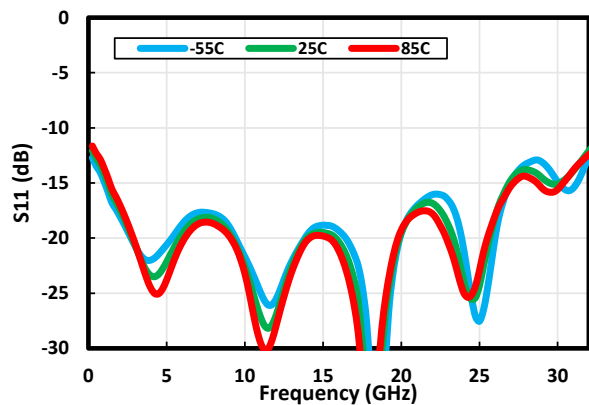

Figure 1-5. S11 vs. Temperature at 6V/150 mA

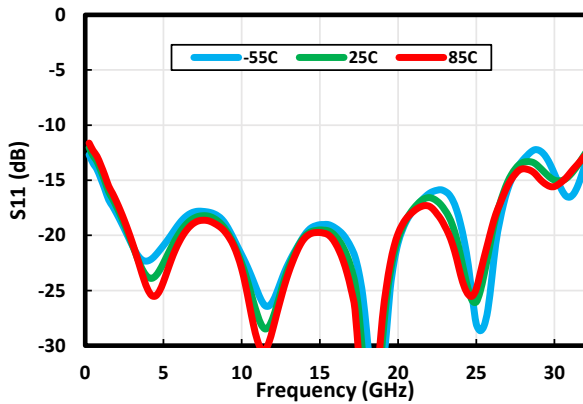

Figure 1-6. S11 vs. Temperature at 7V/180 mA

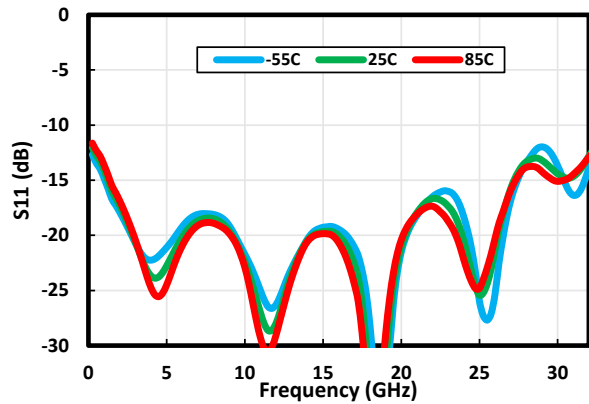

Figure 1-7. S22 vs. Temperature at 5V/100 mA

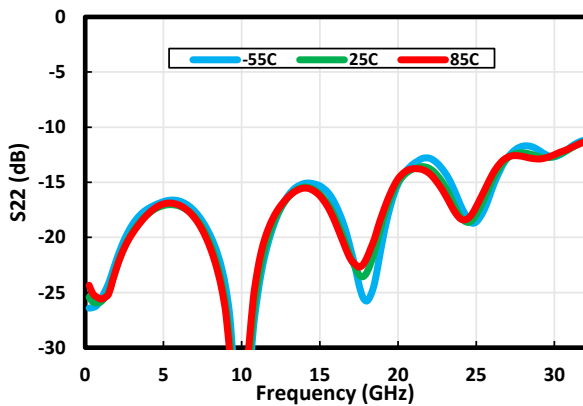

Figure 1-8. S22 vs. Temperature at 6V/150 mA

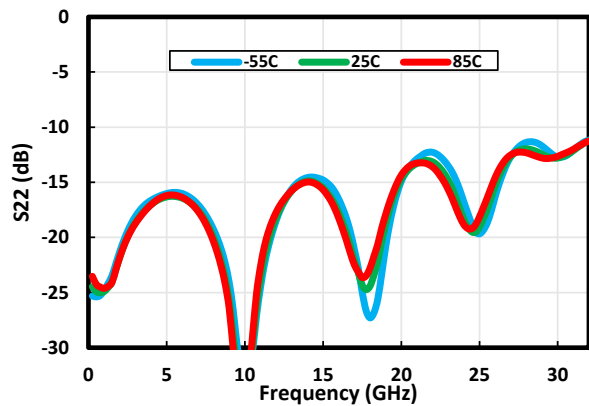

Figure 1-9. S22 vs. Temperature at 7V/180 mA

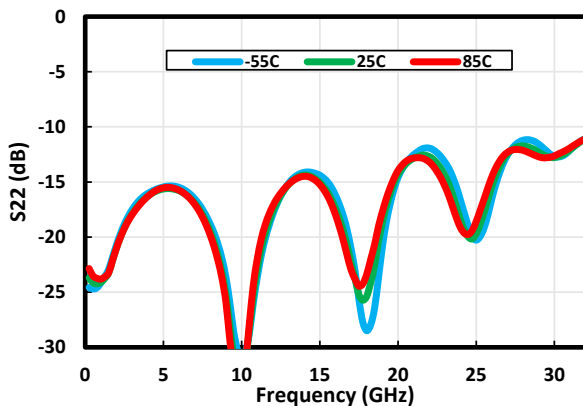

Figure 1-10. S12 vs. Temperature at 5V/100 mA

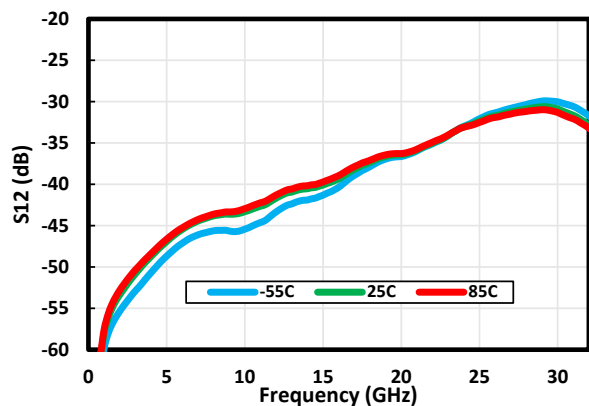

Figure 1-11. S12 vs. Temperature at 6V/150 mA

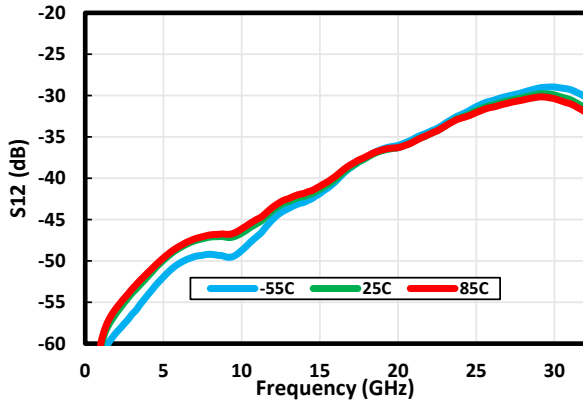

Figure 1-12. S12 vs. Temperature at 7V/180 mA

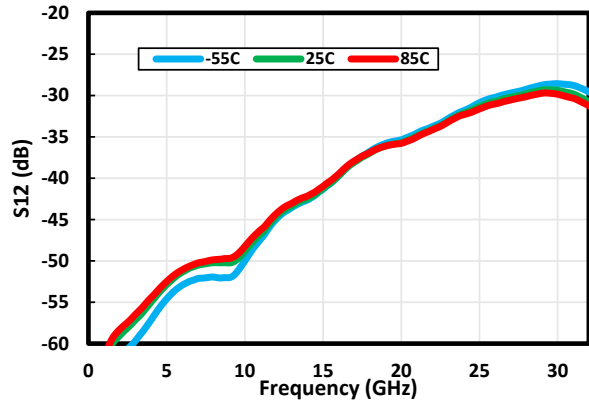

Figure 1-13. NF vs. Temperature at 5V/100 mA

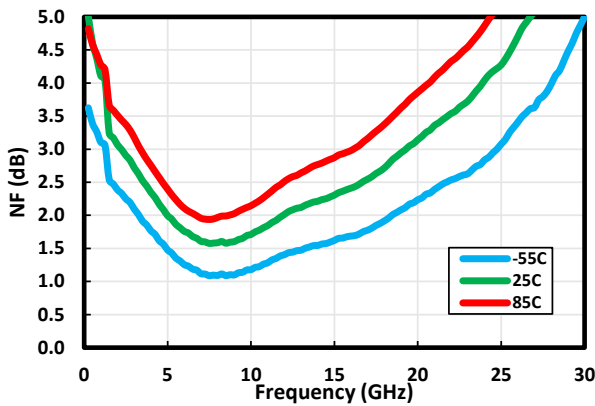

Figure 1-14. NF vs. Temperature at 6V/150 mA

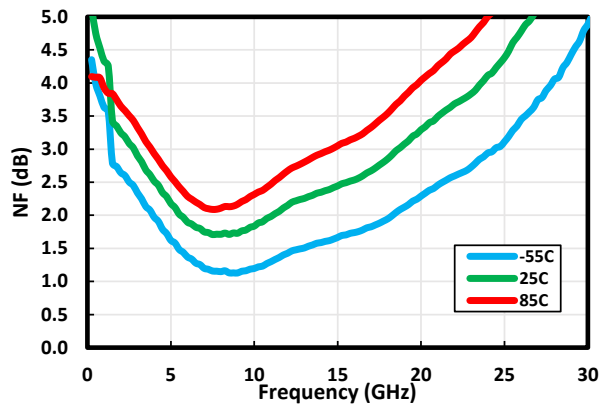

Figure 1-15. NF vs. Temperature at 7V/180 mA

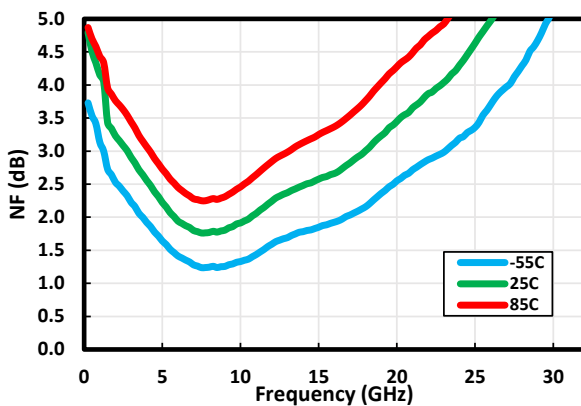

Figure 1-16. P1dB vs. Temperature at 5V/100 mA

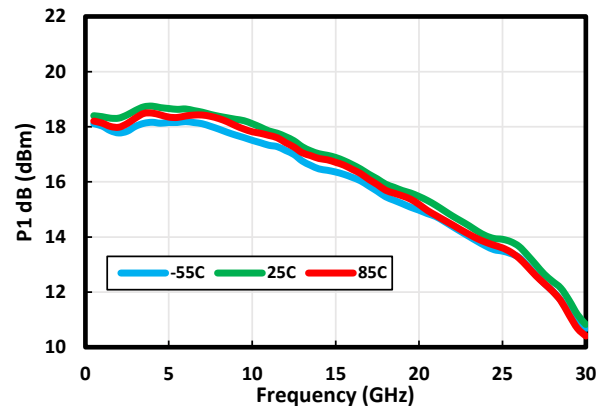

Figure 1-17. P1dB vs. Temperature at 6V/150 mA

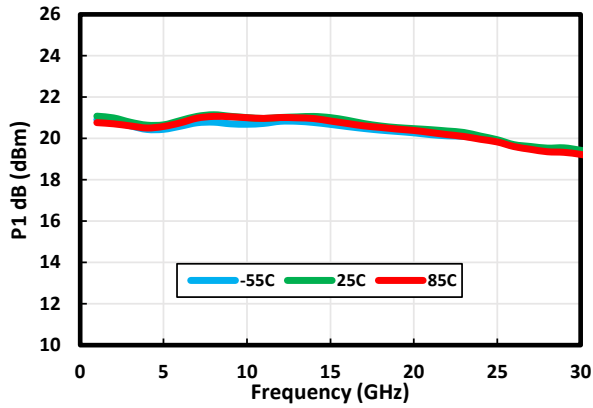

Figure 1-18. P1dB vs. Temperature at 7V/180 mA

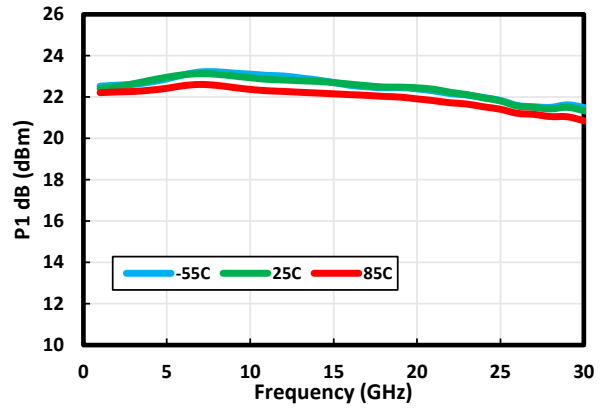

Figure 1-19. Psat vs. Temperature at 5V/100 mA

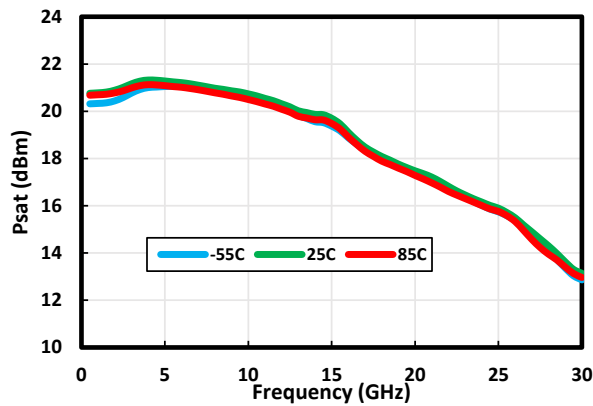

Figure 1-20. Psat vs. Temperature at 6V/150 mA

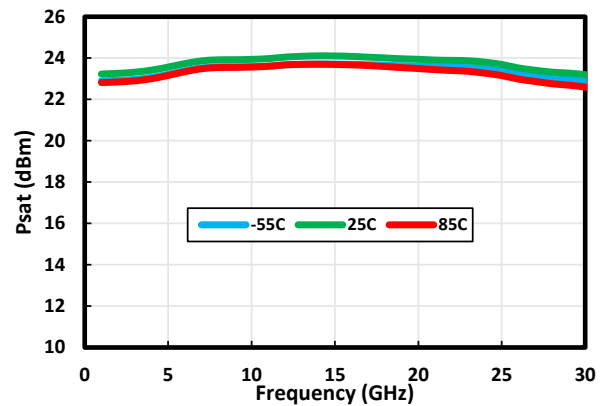

Figure 1-21. Psat vs. Temperature at 7V/180 mA

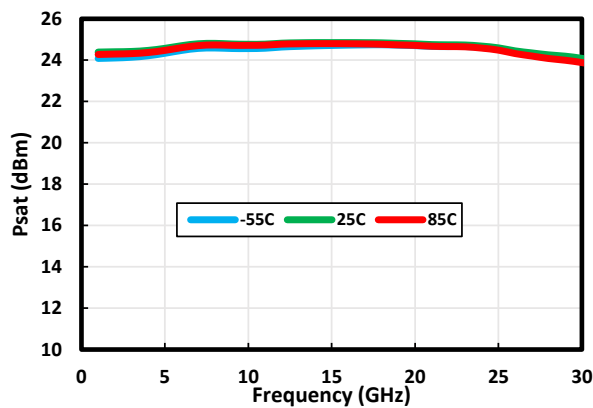

Figure 1-22. OIP3 vs. Temperature at 5V/100 mA

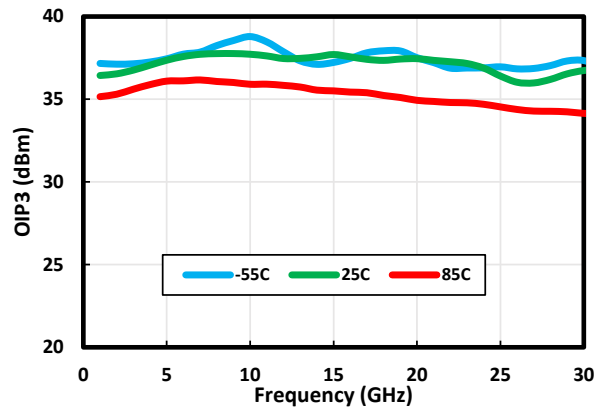

Figure 1-23. OIP3 vs. Temperature at 6V/150 mA

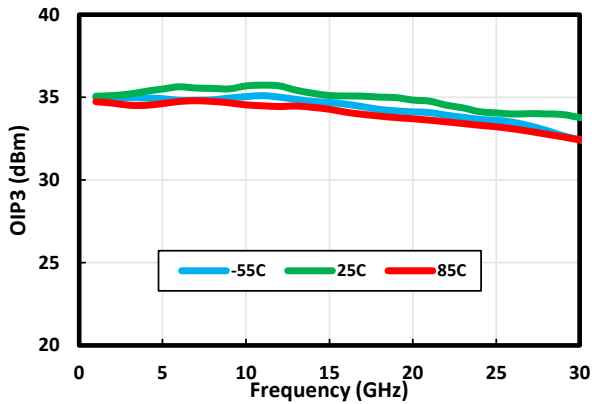

Figure 1-24. OIP3 vs. Temperature at 7V/180 mA

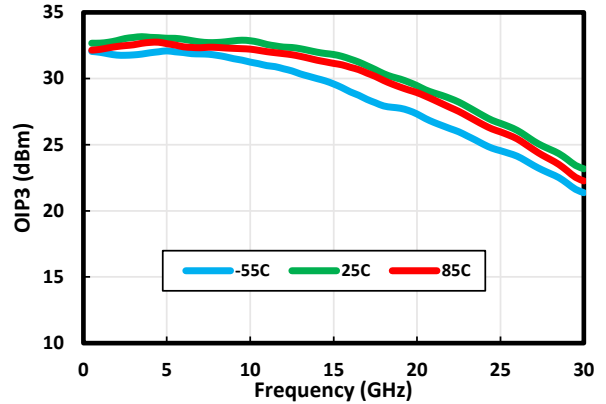

Figure 1-25. OIP2(low) vs. Temperature at 5V/100 mA

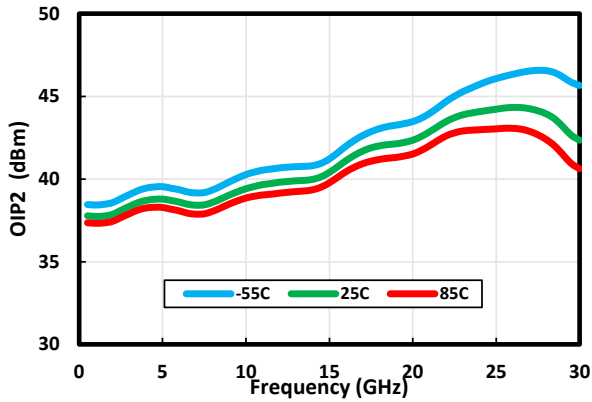

Figure 1-26. OIP2(low) vs. Temperature at 6V/150 mA

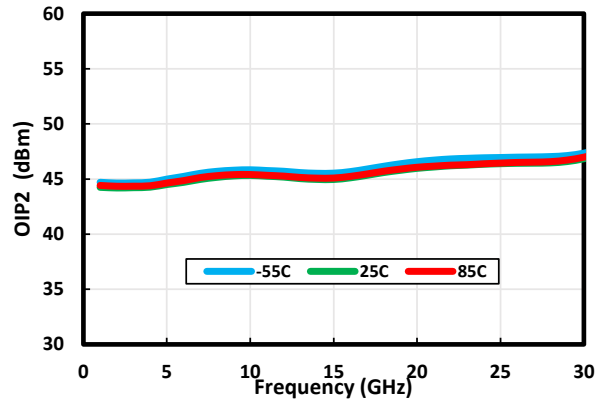

Figure 1-27. OIP2(low) vs. Temperature at 7V/180 mA

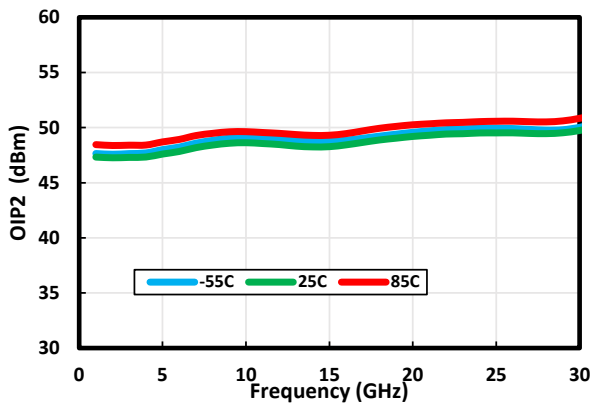

Figure 1-28. IM3 vs. Temperature at 5V/100 mA, 10 dBm (per tone)

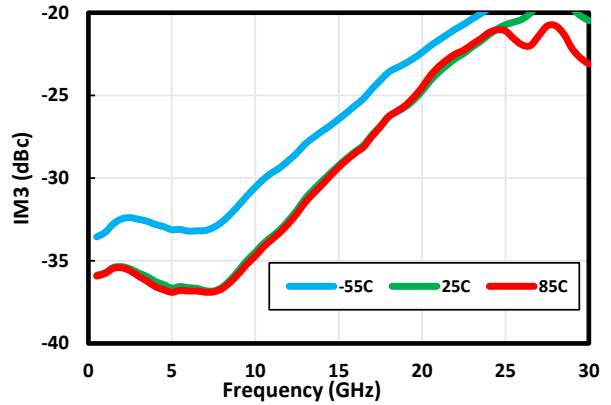

Figure 1-29. IM3 vs. Temperature

at 6V/150 mA, 10 dBm (per tone)

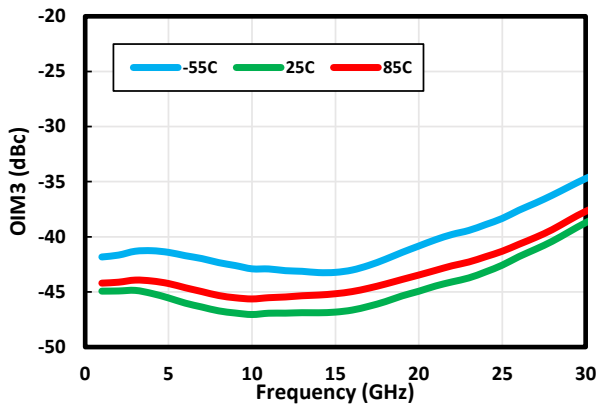
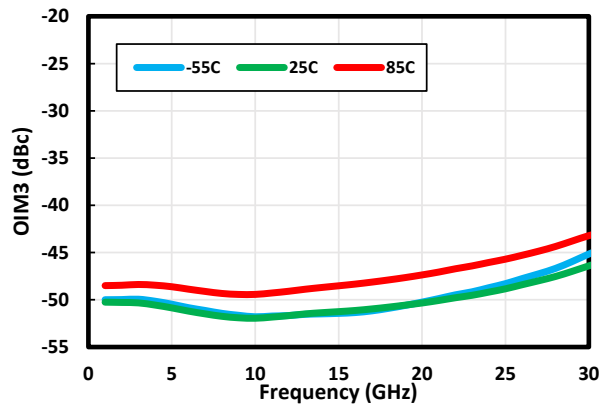

Figure 1-30. IM3 vs. Temperature

at 7V/180 mA, 10 dBm (per tone)



1.3.2 Typical Performances vs. Bias

The following graphs show the typical performance curves of the MMA041AA device at 25 °C vs. bias conditions. All measurements were performed using the test circuit shown in Figure 3-2.

Figure 1-31. Gain vs. V_{DD}/I_{DD}

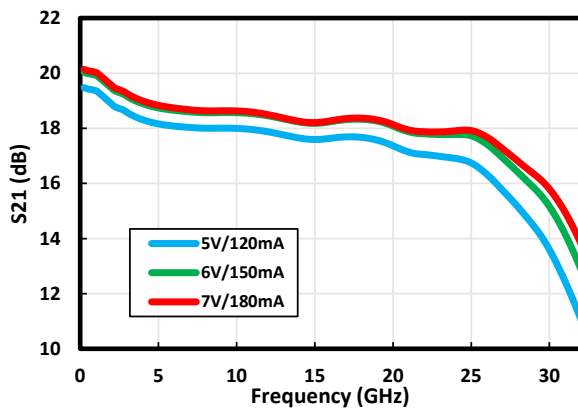

Figure 1-32. NF vs. V_{DD}/I_{DD}

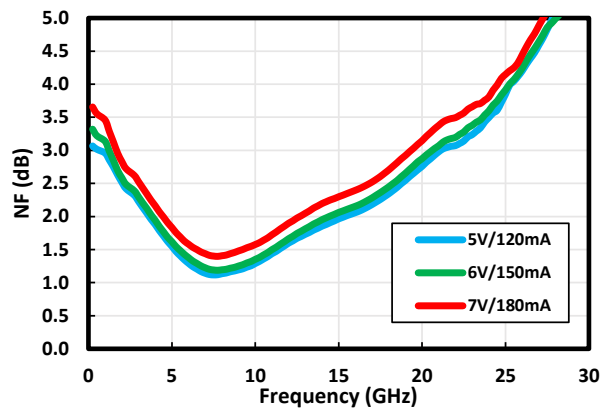

Figure 1-33. S11 vs. V_{DD}/I_{DD}

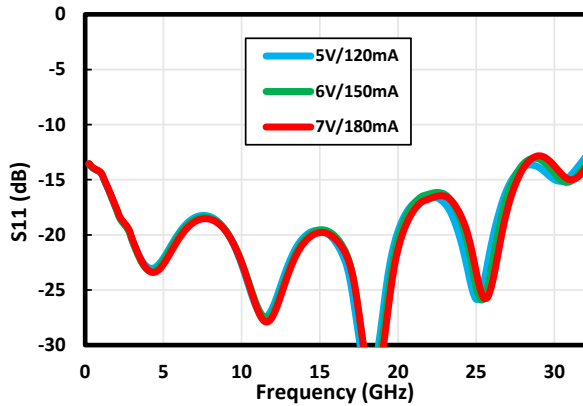

Figure 1-34. S22 vs. V_{DD}/I_{DD}

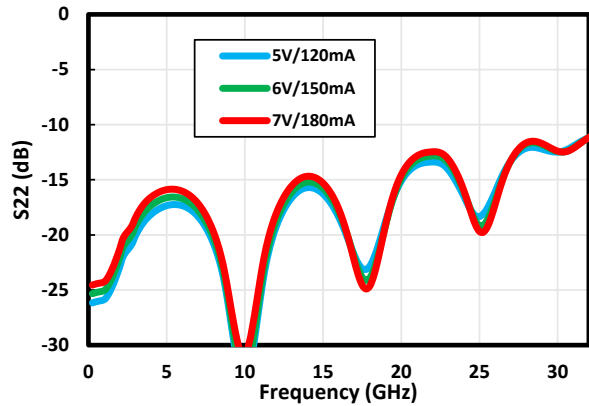

Figure 1-35. S12 vs. V_{DD}/I_{DD}

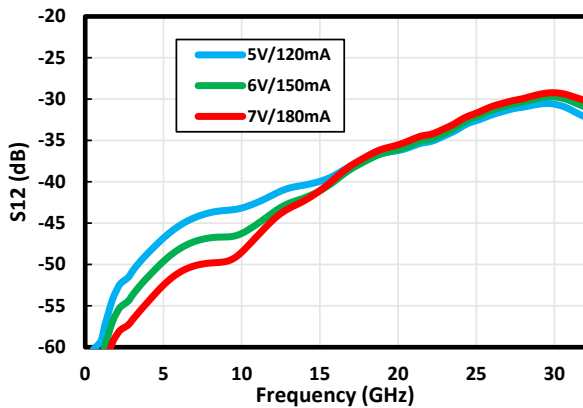

Figure 1-36. P1dB vs. V_{DD}/I_{DD}

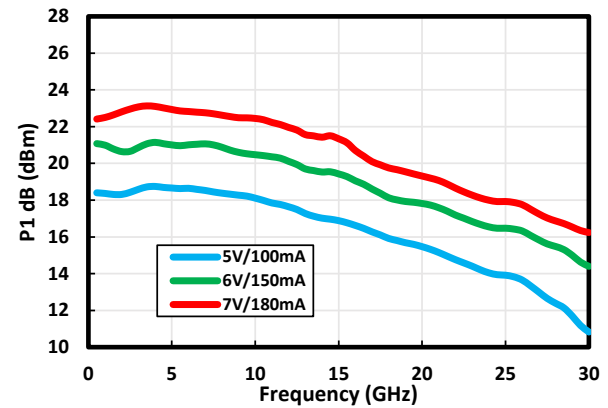

Figure 1-37. Psat vs. V_{DD}/I_{DD}

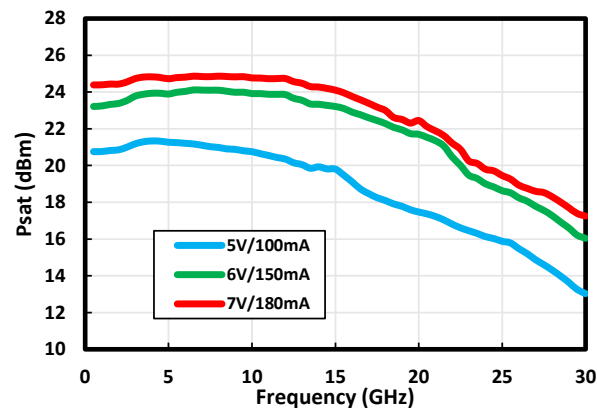

Figure 1-38. OIP3 vs. V_{DD}/I_{DD}

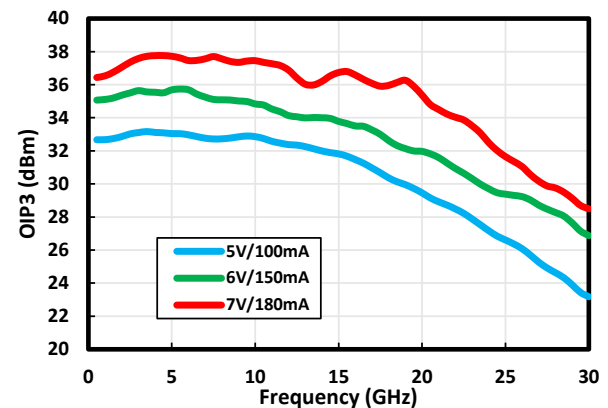

Figure 1-39. OIP2 Low at $\Delta - 10$ MHz vs.

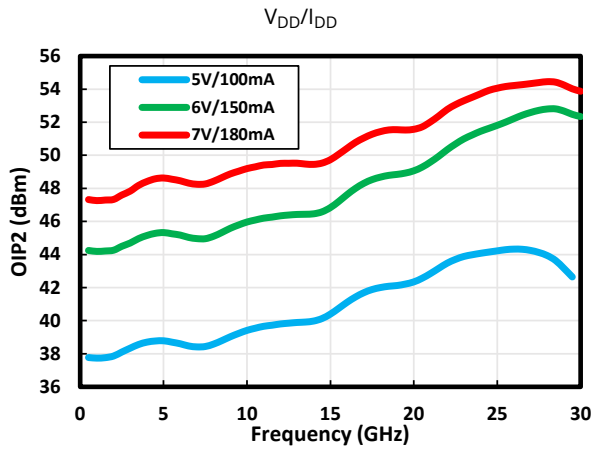
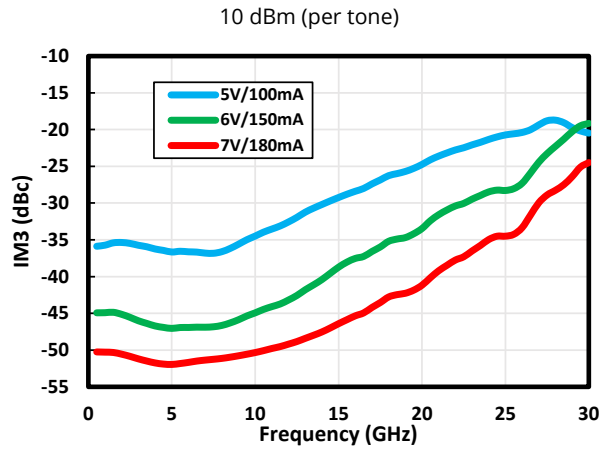

Figure 1-40. IM3 vs. V_{DD}/I_{DD}



1.3.3 Typical Performances vs. Output Power

The following graphs show the typical performance curves of the MMA041AA device at 25 °C vs. Output Power conditions. All measurements were performed using the test circuit shown in Figure 3-2.

Figure 1-41. IM2 vs. Power at 5V/100 mA

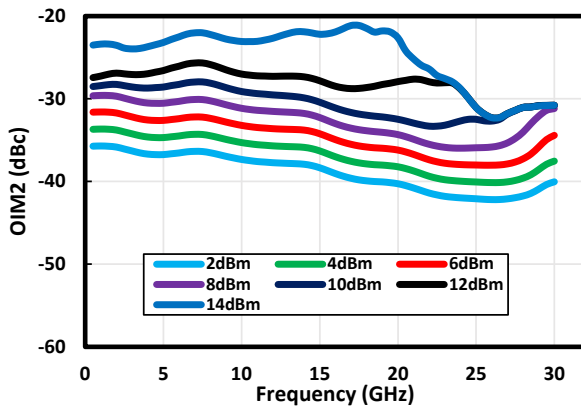

Figure 1-42. IM2 vs. Power at 6V/150 mA

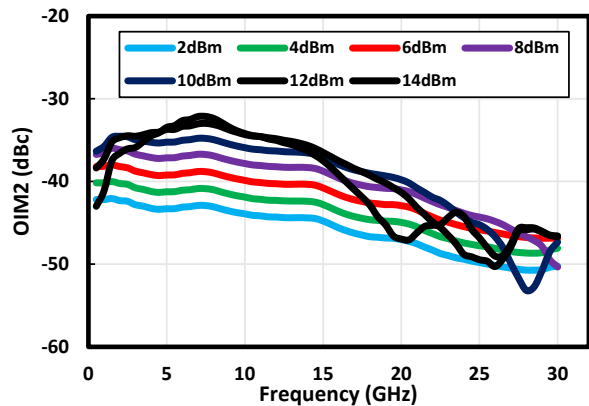

Figure 1-43. IM2 vs. Power at 7V/180 mA

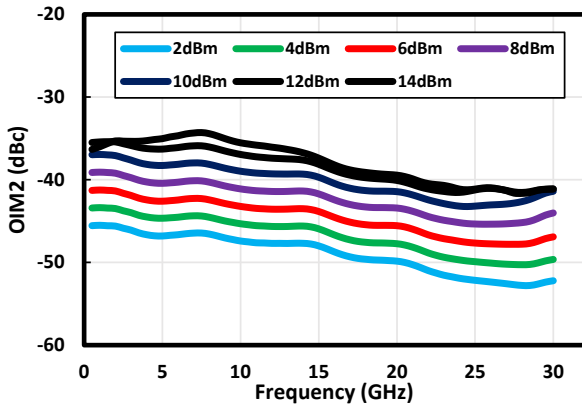

Figure 1-44. IM3 vs. Power at 5V/100 mA

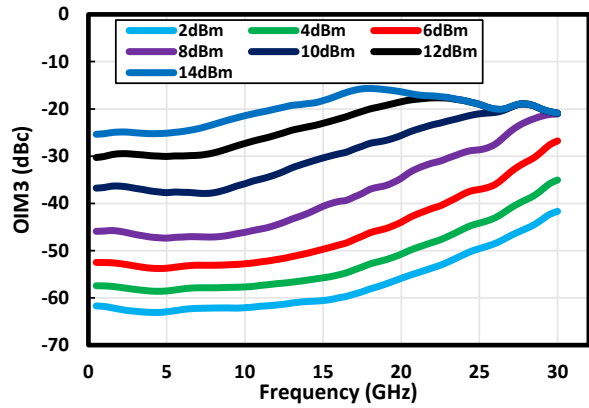

Figure 1-45. IM3 vs. Power at 6V/150 mA

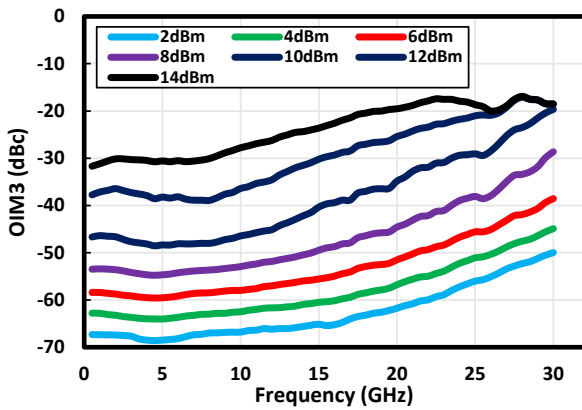

Figure 1-46. IM3 vs. Power at 7V/180 mA

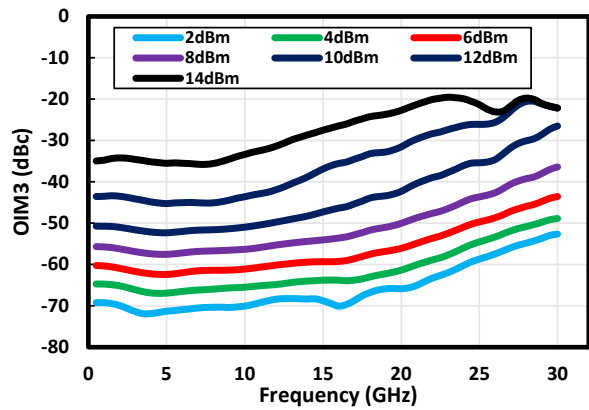

Figure 1-47. 2nd Harmonic vs. Power at 5V/100 mA

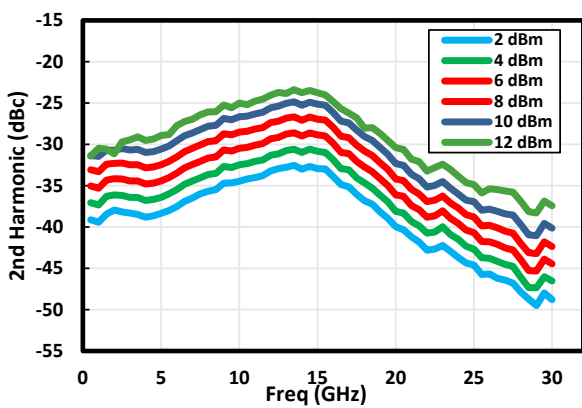

Figure 1-48. 2nd Harmonic vs. Power at 6V/150 mA

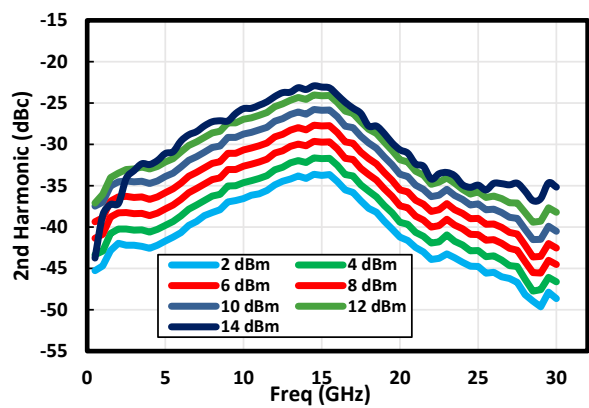
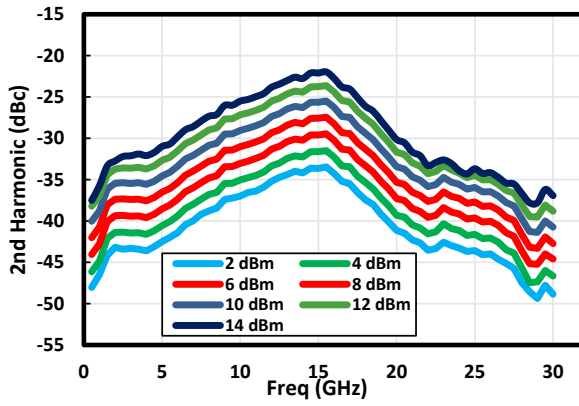

Figure 1-49. 2nd Harmonic vs. Power at 7V/180 mA



2. Die Specifications

The following illustration shows the chip outline of the MMA041AA device. Dimensions are in millimeter and are relative to the zero datum locations shown in the drawing. The minimum bond pad size is 0.1 mm × 0.1 mm. Both the bond pad surface and the backside metal are 3 μm gold. The die thickness is 0.1 mm. The backside is the DC/RF ground. The airbridge keep-out polygon region is shown inside.

Figure 2-1. Die Outline Drawing

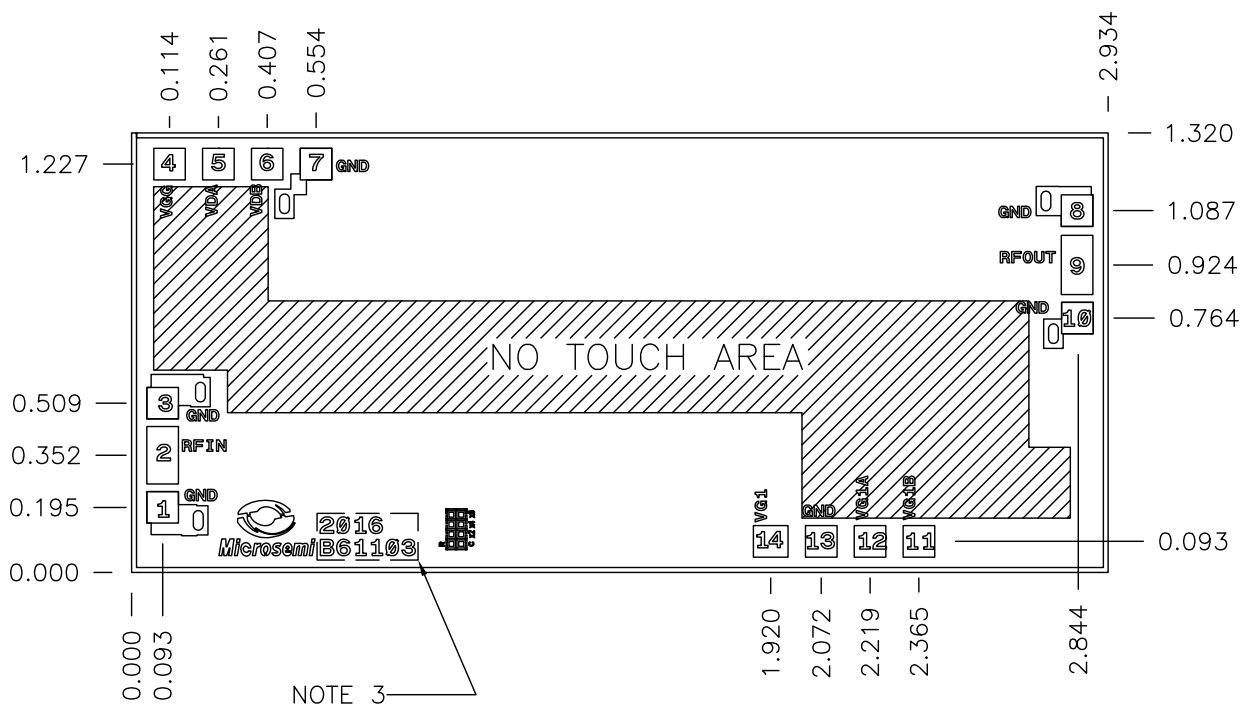

PAD No.	Description	PAD Size
1	GND	0.97 × 0.97
2	RFIN	0.97 × 0.177
3	GND	0.97 × 0.97
4	VGG	0.97 × 0.97
5	VDA	0.97 × 0.97
6	VDB	0.97 × 0.97
7	GND	0.97 × 0.97
8	GND	0.97 × 0.97
9	RFOUT	0.97 × 0.177
10	GND	0.97 × 0.97
11	VG1B	0.97 × 0.97
12	VG1A	0.97 × 0.97
13	GND	0.97 × 0.97
14	VG1	0.97 × 0.97

Notes:

- 1) Dimension are in millimeters.
- 2) Die thickness: 0.100 millimeters.
- 3) Making info:
2016 = Design date
B61103 = Die name

For additional packaging information, contact your Microchip sales representative.

Table 2-1. I/O Pad Description

Pad Number	Pad Name	Pad Description
2	RFIN	DC-coupled and matched to 50Ω.
9	RFOUT + VDD	DC-decoupled and matched to 50Ω. Used for VDD bias.
4	VG2	Second Gate Bias. Connect to VD1A (Optional could be used for gain control by applying external bias in the range of VDD +/- 30%)
5, 6	VD1A, VD1B	Low-frequency termination. Connect bypass capacitors per application circuit below. (Do NOT apply VDD bias to this connections)
11, 12	VG1A, VG1B	Low-frequency termination. Connect bypass capacitors per application circuit below at Figure 51
14	VG1	Gate control for amplifier. Adjust to achieve $I_{DD} = 150 \text{ mA}$
1, 3, 7, 8, 10, 13	Ground	RF/DC Ground pads, not used in typical applications.
Backside paddle	RF/DC GND	Must be connected to RF/DC Ground

3. Application Circuit

Figure 3-1. Application Circuit: Schematic

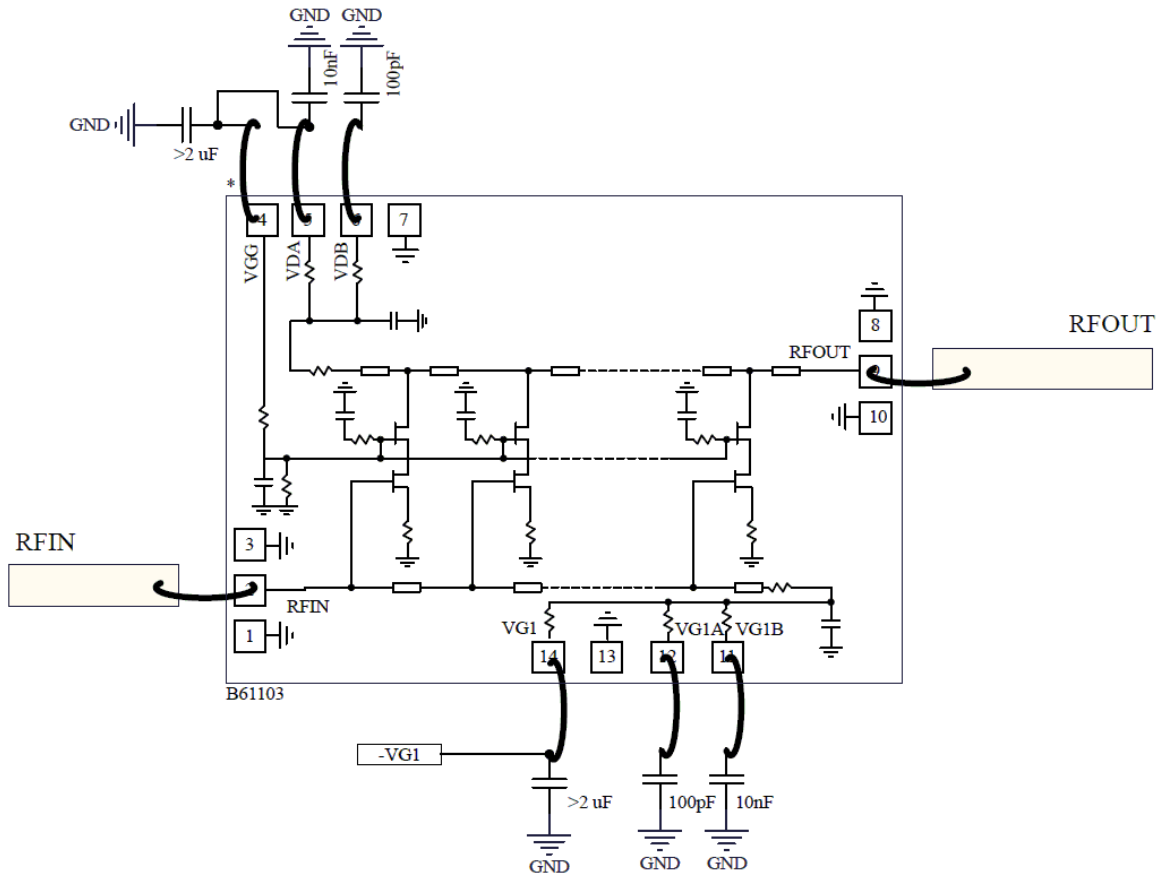

Figure 3-2. Test Circuit DC–26 GHz: Assembly Drawing

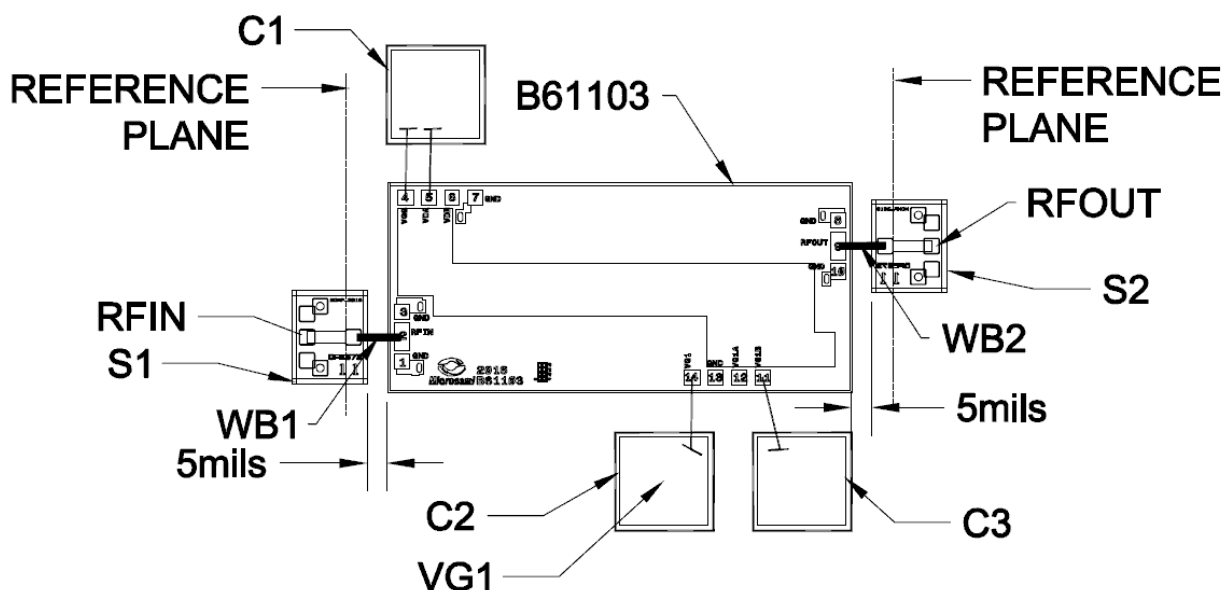

Table 3-1. List of Materials for Assembly Drawing

Reference	Part Number	Description
B61103	MMA041AA	Amplifier Die
C1 ... C3	160U02A102MT4W	Johanson Dielectric SLC 1 nF (Values could be different from the Application Circuit Schematic for ease of Test Circuit Assembly)
S1, S2	E57311	Microchip Probe Launchers, calibrated with the TRL kit to Ref. Planes shown
WB1, WB2	744-903-06	Microchip 2 mils Gold Ribbon, Should be as short as possible
RFIN/RFOUT		Location of the Input/Output GSG (150 μ m) probes
VG1		Needle contact location for DC connection to VG1 (should be grounded if not used)

Table 3-2. Bias Sequence

Bias Sequence
1) Set the gate voltage VG1 to -1V
2) Set drain voltage VDD to 6V (or as applications require)
3) Adjust the Gate Voltage by increments <0.01V until current reaches required value

4. Ordering, Shipping, and Handling

4.1 Handling Recommendations

Gallium Arsenide integrated circuits are sensitive to electrostatic discharge (ESD) and can be damaged by static electricity. It is recommended to follow all procedures and guidelines outlined in the Microsemi application note AN01: GaAs MMIC Handling and Die Attach Recommendations.

4.2 Ordering Information

For additional ordering information, contact your Microchip sales representative.

Part Number	Package
MMA041AA	Bare die
MMA041PP5	5 mm × 5 mm, 32L SMT
MMA041PP5/TR	Tape and reel
MMA041PP5E	Evaluation board for MMA041PP5

4.3 Packing Information

Standard Format
Gel pack
50 pieces per pack

5. Revision History

The revision history describes the changes that were implemented in the document. The changes are listed by revision, starting with the most current publication.

Table 5-1. Revision History

Revision	Date	Description
B	06/2024	Electrical data updated and performance curves reformatted.
A	07/2022	Document migrated from Microsemi template to Microchip template; Assigned Microchip literature number DS-00004636.
Initial release (Microsemi Revision A)	2016	Document created.

Microchip Information

The Microchip Website

Microchip provides online support via our website at www.microchip.com/. This website is used to make files and information easily available to customers. Some of the content available includes:

- **Product Support** – Data sheets and errata, application notes and sample programs, design resources, user’s guides and hardware support documents, latest software releases and archived software
- **General Technical Support** – Frequently Asked Questions (FAQs), technical support requests, online discussion groups, Microchip design partner program member listing
- **Business of Microchip** – Product selector and ordering guides, latest Microchip press releases, listing of seminars and events, listings of Microchip sales offices, distributors and factory representatives

Product Change Notification Service

Microchip’s product change notification service helps keep customers current on Microchip products. Subscribers will receive email notification whenever there are changes, updates, revisions or errata related to a specified product family or development tool of interest.

To register, go to www.microchip.com/pcn and follow the registration instructions.

Customer Support

Users of Microchip products can receive assistance through several channels:

- Distributor or Representative
- Local Sales Office
- Embedded Solutions Engineer (ESE)
- Technical Support

Customers should contact their distributor, representative or ESE for support. Local sales offices are also available to help customers. A listing of sales offices and locations is included in this document.

Technical support is available through the website at: www.microchip.com/support

Microchip Devices Code Protection Feature

Note the following details of the code protection feature on Microchip products:

- Microchip products meet the specifications contained in their particular Microchip Data Sheet.
- Microchip believes that its family of products is secure when used in the intended manner, within operating specifications, and under normal conditions.
- Microchip values and aggressively protects its intellectual property rights. Attempts to breach the code protection features of Microchip product is strictly prohibited and may violate the Digital Millennium Copyright Act.
- Neither Microchip nor any other semiconductor manufacturer can guarantee the security of its code. Code protection does not mean that we are guaranteeing the product is “unbreakable”. Code protection is constantly evolving. Microchip is committed to continuously improving the code protection features of our products.

Legal Notice

This publication and the information herein may be used only with Microchip products, including to design, test, and integrate Microchip products with your application. Use of this information in any other manner violates these terms. Information regarding device applications is provided only for your convenience and may be superseded by updates. It is your responsibility to ensure

that your application meets with your specifications. Contact your local Microchip sales office for additional support or, obtain additional support at www.microchip.com/en-us/support/design-help/client-support-services.

THIS INFORMATION IS PROVIDED BY MICROCHIP "AS IS". MICROCHIP MAKES NO REPRESENTATIONS OR WARRANTIES OF ANY KIND WHETHER EXPRESS OR IMPLIED, WRITTEN OR ORAL, STATUTORY OR OTHERWISE, RELATED TO THE INFORMATION INCLUDING BUT NOT LIMITED TO ANY IMPLIED WARRANTIES OF NON-INFRINGEMENT, MERCHANTABILITY, AND FITNESS FOR A PARTICULAR PURPOSE, OR WARRANTIES RELATED TO ITS CONDITION, QUALITY, OR PERFORMANCE.

IN NO EVENT WILL MICROCHIP BE LIABLE FOR ANY INDIRECT, SPECIAL, PUNITIVE, INCIDENTAL, OR CONSEQUENTIAL LOSS, DAMAGE, COST, OR EXPENSE OF ANY KIND WHATSOEVER RELATED TO THE INFORMATION OR ITS USE, HOWEVER CAUSED, EVEN IF MICROCHIP HAS BEEN ADVISED OF THE POSSIBILITY OR THE DAMAGES ARE FORESEEABLE. TO THE FULLEST EXTENT ALLOWED BY LAW, MICROCHIP'S TOTAL LIABILITY ON ALL CLAIMS IN ANY WAY RELATED TO THE INFORMATION OR ITS USE WILL NOT EXCEED THE AMOUNT OF FEES, IF ANY, THAT YOU HAVE PAID DIRECTLY TO MICROCHIP FOR THE INFORMATION.

Use of Microchip devices in life support and/or safety applications is entirely at the buyer's risk, and the buyer agrees to defend, indemnify and hold harmless Microchip from any and all damages, claims, suits, or expenses resulting from such use. No licenses are conveyed, implicitly or otherwise, under any Microchip intellectual property rights unless otherwise stated.

Trademarks

The Microchip name and logo, the Microchip logo, Adaptec, AVR, AVR logo, AVR Freaks, BesTime, BitCloud, CryptoMemory, CryptoRF, dsPIC, flexPWR, HELDO, IGLOO, JukeBlox, KeeLoq, Kleer, LANCheck, LinkMD, maXStylus, maXTouch, MediaLB, megaAVR, Microsemi, Microsemi logo, MOST, MOST logo, MPLAB, OptoLyzer, PIC, picoPower, PICSTART, PIC32 logo, PolarFire, Prochip Designer, QTouch, SAM-BA, SenGenuity, SpyNIC, SST, SST Logo, SuperFlash, Symmetricom, SyncServer, Tachyon, TimeSource, tinyAVR, UNI/O, Vectron, and XMEGA are registered trademarks of Microchip Technology Incorporated in the U.S.A. and other countries.

AgileSwitch, ClockWorks, The Embedded Control Solutions Company, EtherSynch, Flashtec, Hyper Speed Control, HyperLight Load, Libero, motorBench, mTouch, Powermite 3, Precision Edge, ProASIC, ProASIC Plus, ProASIC Plus logo, Quiet-Wire, SmartFusion, SyncWorld, TimeCesium, TimeHub, TimePictra, TimeProvider, and ZL are registered trademarks of Microchip Technology Incorporated in the U.S.A.

Adjacent Key Suppression, AKS, Analog-for-the-Digital Age, Any Capacitor, AnyIn, AnyOut, Augmented Switching, BlueSky, BodyCom, Clockstudio, CodeGuard, CryptoAuthentication, CryptoAutomotive, CryptoCompanion, CryptoController, dsPICDEM, dsPICDEM.net, Dynamic Average Matching, DAM, ECAN, Espresso T1S, EtherGREEN, EyeOpen, GridTime, IdealBridge, IGaT, In-Circuit Serial Programming, ICSP, INICnet, Intelligent Paralleling, IntelliMOS, Inter-Chip Connectivity, JitterBlocker, Knob-on-Display, MarginLink, maxCrypto, maxView, memBrain, Minda, MiWi, MPASM, MPF, MPLAB Certified logo, MPLIB, MPLINK, mSiC, MultiTRAK, NetDetach, Omniscient Code Generation, PICDEM, PICDEM.net, PICkit, PICtail, Power MOS IV, Power MOS 7, PowerSmart, PureSilicon, QMatrix, REAL ICE, Ripple Blocker, RTAX, RTG4, SAM-ICE, Serial Quad I/O, simpleMAP, SimpliPHY, SmartBuffer, SmartHLS, SMART-I.S., storClad, SQI, SuperSwitcher, SuperSwitcher II, Switchtec, SynchroPHY, Total Endurance, Trusted Time, TSHARC, Turing, USBCheck, VariSense, VectorBlox, VeriPHY, ViewSpan, WiperLock, XpressConnect, and ZENA are trademarks of Microchip Technology Incorporated in the U.S.A. and other countries.

SQTP is a service mark of Microchip Technology Incorporated in the U.S.A.

The Adaptec logo, Frequency on Demand, Silicon Storage Technology, and Symmcom are registered trademarks of Microchip Technology Inc. in other countries.

GestIC is a registered trademark of Microchip Technology Germany II GmbH & Co. KG, a subsidiary of Microchip Technology Inc., in other countries.

All other trademarks mentioned herein are property of their respective companies.

© 2024, Microchip Technology Incorporated and its subsidiaries. All Rights Reserved.

ISBN: 978-1-6683-4598-6

Quality Management System

For information regarding Microchip's Quality Management Systems, please visit www.microchip.com/quality.

Worldwide Sales and Service

AMERICAS	ASIA/PACIFIC	ASIA/PACIFIC	EUROPE
Corporate Office 2355 West Chandler Blvd. Chandler, AZ 85224-6199 Tel: 480-792-7200 Fax: 480-792-7277 Technical Support: www.microchip.com/support Web Address: www.microchip.com	Australia - Sydney Tel: 61-2-9868-6733 China - Beijing Tel: 86-10-8569-7000 China - Chengdu Tel: 86-28-8665-5511 China - Chongqing Tel: 86-23-8980-9588 China - Dongguan Tel: 86-769-8702-9880 China - Guangzhou Tel: 86-20-8755-8029 China - Hangzhou Tel: 86-571-8792-8115 China - Hong Kong SAR Tel: 852-2943-5100 China - Nanjing Tel: 86-25-8473-2460 China - Qingdao Tel: 86-532-8502-7355 China - Shanghai Tel: 86-21-3326-8000 China - Shenyang Tel: 86-24-2334-2829 China - Shenzhen Tel: 86-755-8864-2200 China - Suzhou Tel: 86-186-6233-1526 China - Wuhan Tel: 86-27-5980-5300 China - Xian Tel: 86-29-8833-7252 China - Xiamen Tel: 86-592-2388138 China - Zhuhai Tel: 86-756-3210040	India - Bangalore Tel: 91-80-3090-4444 India - New Delhi Tel: 91-11-4160-8631 India - Pune Tel: 91-20-4121-0141 Japan - Osaka Tel: 81-6-6152-7160 Japan - Tokyo Tel: 81-3-6880-3770 Korea - Daegu Tel: 82-53-744-4301 Korea - Seoul Tel: 82-2-554-7200 Malaysia - Kuala Lumpur Tel: 60-3-7651-7906 Malaysia - Penang Tel: 60-4-227-8870 Philippines - Manila Tel: 63-2-634-9065 Singapore Tel: 65-6334-8870 Taiwan - Hsin Chu Tel: 886-3-577-8366 Taiwan - Kaohsiung Tel: 886-7-213-7830 Taiwan - Taipei Tel: 886-2-2508-8600 Thailand - Bangkok Tel: 66-2-694-1351 Vietnam - Ho Chi Minh Tel: 84-28-5448-2100	Austria - Wels Tel: 43-7242-2244-39 Fax: 43-7242-2244-393 Denmark - Copenhagen Tel: 45-4485-5910 Fax: 45-4485-2829 Finland - Espoo Tel: 358-9-4520-820 France - Paris Tel: 33-1-69-53-63-20 Fax: 33-1-69-30-90-79 Germany - Garching Tel: 49-8931-9700 Germany - Haan Tel: 49-2129-3766400 Germany - Heilbronn Tel: 49-7131-72400 Germany - Karlsruhe Tel: 49-721-625370 Germany - Munich Tel: 49-89-627-144-0 Fax: 49-89-627-144-44 Germany - Rosenheim Tel: 49-8031-354-560 Israel - Ra'anana Tel: 972-9-744-7705 Italy - Milan Tel: 39-0331-742611 Fax: 39-0331-466781 Italy - Padova Tel: 39-049-7625286 Netherlands - Drunen Tel: 31-416-690399 Fax: 31-416-690340 Norway - Trondheim Tel: 47-72884388 Poland - Warsaw Tel: 48-22-3325737 Romania - Bucharest Tel: 40-21-407-87-50 Spain - Madrid Tel: 34-91-708-08-90 Fax: 34-91-708-08-91 Sweden - Gothenberg Tel: 46-31-704-60-40 Sweden - Stockholm Tel: 46-8-5090-4654 UK - Wokingham Tel: 44-118-921-5800 Fax: 44-118-921-5820

Looking for pricing, stock, or lifecycle information?

Click below to explore more details on WIN SOURCE:

- ⊖ [View MMA041AA](#) on WIN SOURCE
- ⊖ [Microchip Technology](#) Information

Optimize Your Supply Chain with WIN SOURCE Solutions

- ✓ Global Sourcing Solution
- ✓ Obsolete Management
- ✓ Cost Control Management
- ✓ Shortage Management
- ✓ Alternative Solution
- ✓ Excess Inventory Management