

Product Overview

The QPB8857 is a GaAs pHEMT/MESFET 75-ohm Doubler RF amplifier IC featuring over 28dB of flat gain and low noise. This IC is designed to support DOCSIS 3.1 applications up to 1218MHz using a single 24V supply. The QPB8857 offers low noise and low distortion at high efficiency consuming only 10.5W in a 5x7 QFN package. Its compact size and low Θ_{jc} enable integration that is ideally suited for hybrid module or an alternative to hybrid module applications.

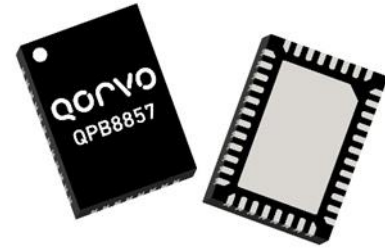

40 pin 5x7 QFN Package

Functional Block Diagram

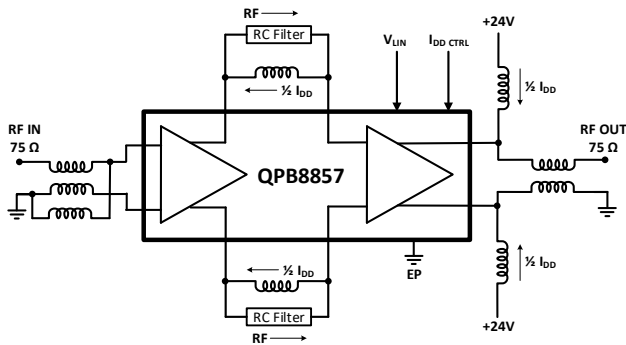

Key Features

- High Gain: 28dB @ 1218MHz
- Adjustable Bias
- 47 - 1218 MHz BW
- 57dBmV/ch virtual 1.2GHz, at 19dB tilt
- Low Noise: 4.5dB
- Excellent Composite Distortion
- pHEMT / MESFET device technologies
- Compact Size: 40P 5x7 QFN
- Power Consumption (24V, 440mA – 10.5W)

Applications

- DOCSIS 3.1
- Broadband CATV hybrid modules
- Head End CMTS Equipment
- 75-ohm amplifiers

Ordering Information

Part No.	Description
QPB8857SB	Sample bag with 5 pieces
QPB8857SR	7" Reel with 100 pieces
QPB8857TR13	13" Reel with 2500 pieces
QPB8857EVB	47 – 1218MHz PCBA

Absolute Maximum Ratings

Parameter	Rating
Supply Voltage (V _{DD})	+30V (5min)
Supply Current (I _{DD})	570mA
Maximum Input Level (single tone)	+70dBmV
Operating Temperature Range	-40 to +90°C
Storage Temperature Range	-65 to +150°C
Maximum Junction Temperature	+150°C

Exceeding any one or a combination of the Absolute Maximum Rating conditions may cause permanent damage to the device. Extended application of Absolute Maximum Rating conditions to the device may reduce device reliability.

Electrical Specifications – 24V

Parameter	Condition ⁽¹⁾	Min	Typ	Max	Unit
Supply Voltage (V _{DD})			24		V
Supply Current (I _{DD})	V _{DD} total current		440		mA
Frequency Range		50		1218	MHz
Gain ²	1218MHz		28		dB
Gain Flatness	Max. deviation from line using least squares fit from 47 to 1218 MHz		±0.5		dB
Gain Slope	Gain(1218MHz) - Gain(50MHz)		1.0		dB
Reverse Isolation			-42		dB
Input Return Loss			18		dB
Output Return Loss			18		dB
Noise Figure			4.5		dB
CSO	80 NTSC + 111 QAM (-6dB offset), 57dBmV/ch out, 19dB tilt		-81		dBc
CTB			-83		dBc
CCN			60		dB
OIP2	Low band: 225MHz, 275.5MHz, 16dBm/tone		92		dBm
	High band: 1100MHz, 1150.5MHz, 16dBm/tone		88		dBm
OIP3	Low band: 225MHz, 275.5MHz, 16dBm/tone		53		dBm
	High band: 1100MHz, 1150.5MHz, 16dBm/tone		48		dBm
Output P1dB	1218 MHz		31		dBm
Thermal Resistance	Θ _{JB} (Junction to backside of QFN)		6		°C/W

Notes:

1. Typical performance at these conditions: Temp = +25°C, V_{DD} = +24V, 75Ω system, Full band unless otherwise noted

Evaluation Board Schematic

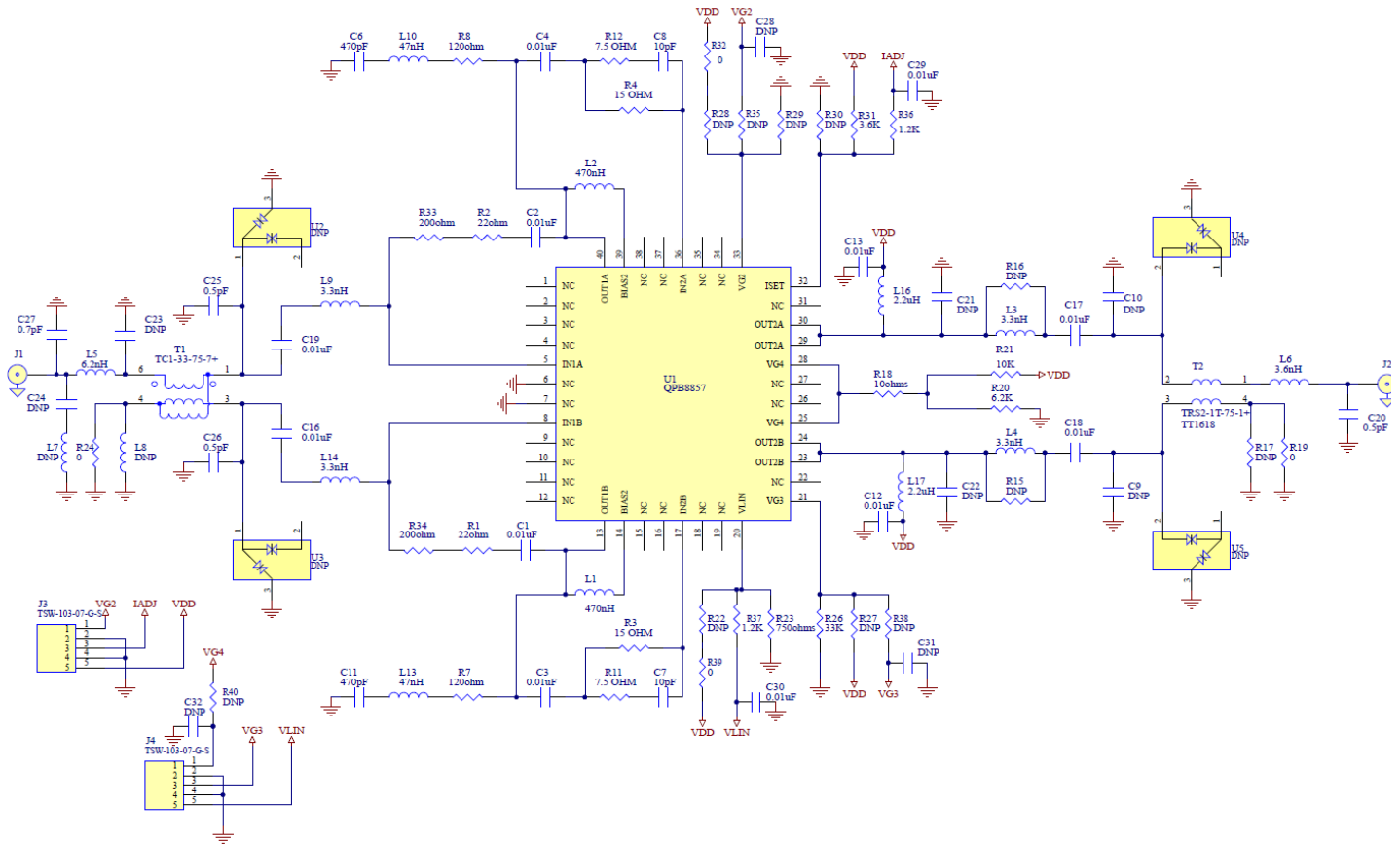

**Evaluation Board Bill of Materials**

Reference Designator	Description	Manufacturer	PART #
U1	1.2GHz, 28dB Power Doubler	Qorvo	QPB8857
C1,C2,C3,C4,C12, C13,C16,C17,C18, C19,C29,C30	CAP, 0.01uF, ±10%, 50V, X7R, 0402	MURATA	GRM155R71H103KA88D
C20,C25,C26	CAP0402, 0.5pF, ±0.1pF, 50V, C0G, HIQ	MURATA	GJM1555C1HR50BB01D
C7,C8	CAP0402, 10pF, ±2%, 50V, C0G, HIQ	MURATA	GJM1555C1H100GB01D
C6,C11	CAP, 470pF, 5%, 50V, C0G, 0402	MURATA	GRM1555C1H471JA01D
C27	CAP, 0.7pF, +/-0.05pF, 50V, C0G, 0402	MURATA	GRM1555C1HR70WA01D
R3,R4	RES, 15 OHM, 1%, 1/16W, 0402	Kamaya	RMC1/16S-150FTH
R18	RES, 10 OHM, 1%, 1/16W, 0402	Panasonic	ERJ-2RKF10R0X
R19,R24	RES, 0 OHM, 5%, 1/10W, 0402	Kamaya	RMC1/16SJPTH
R11,R12	RES, 7.5 OHM, 5%, 1/16W, 0402	Kamaya	RMC1/16S-7R5JTH
R33,R34	RES, 200 OHM, 1%, 1/16W, 0402	Panasonic	ERJ-2RKF2000X
R21	RES, 10K, 1%, 1/16W, 0402	Panasonic	ERJ-2RKF1002X
R23	RES, 750 OHM, 1%, 1/16W, 0402	Panasonic	ERJ-2RKF7500X
R26	RES, 33K, 1%, 1/16W, 0402	Yageo	RC0402FR-0733KL
R31	RES, 3.6K, 1%, 1/10W, 0402	Panasonic	ERJ-2RKF3601X
R20	RES, 6.2K, 1%, 1/10W, 0402	Panasonic	ERJ-2RKF6201X
R32,R39	RES, 0 OHM, 0603	Kamaya	RMC1/16JPTP
R36,R37	RES, 1.2K, 5%, 1/16W, 0402	Panasonic	ERJ-2GEJ122
R1,R2	RES, 22 OHM, 5%, 1/16W, 0402	Panasonic	ERJ-2GEJ220
R7,R8	120 OHM,1%,1/16W,0402 LEAD FREE	KOA	RK73H1ETTP1200F
L1,L2	IND, 470nH, ±5%, 310mA, 650mHZ, 0402	Coilcraft, Inc.	0402AF-471XJLW
L10,L13	IND, 47nH, 5%, M/L, 0402	MURATA	LQG15HN47NJ02D
L3,L4,L9,L14	IND, 3.3nH, +/-0.1nH, M/L, 0402	MURATA	LQG15HS3N3B02D
L6	IND, 3.6nH, +/-0.1nH, M/L, 0402	MURATA	LQG15HS3N6B02D
L5	IND, 6.2nH, +/-0.1nH, M/L, 0402	MURATA	LQG15HS6N2B02D
L16,L17	IND, 2.2uH, 20%, 0.36A, 0.7mm, W/W, 0603	Taiyo Yuden	BRL1608T2R2M
T1	XFMR, SMT, 75 OHM, CD542, 1:1 BALUN, TC1	Mini Circuits	TC1-33-75-7+
T2	Transformer, 2:1, 5 to 1200 MHz, TT1618	Minicircuits	TRS2-1T-75-1+
R15,R16,R17,R22, R27,R28,R29,R30, R35,R38,R40	Not Populated		
C9,C10,C21,C22,C23, C24,C28,C31,C32,L7, L8,U2,U3,U4,U5	Not Populated		

Evaluation Board Assembly Drawing

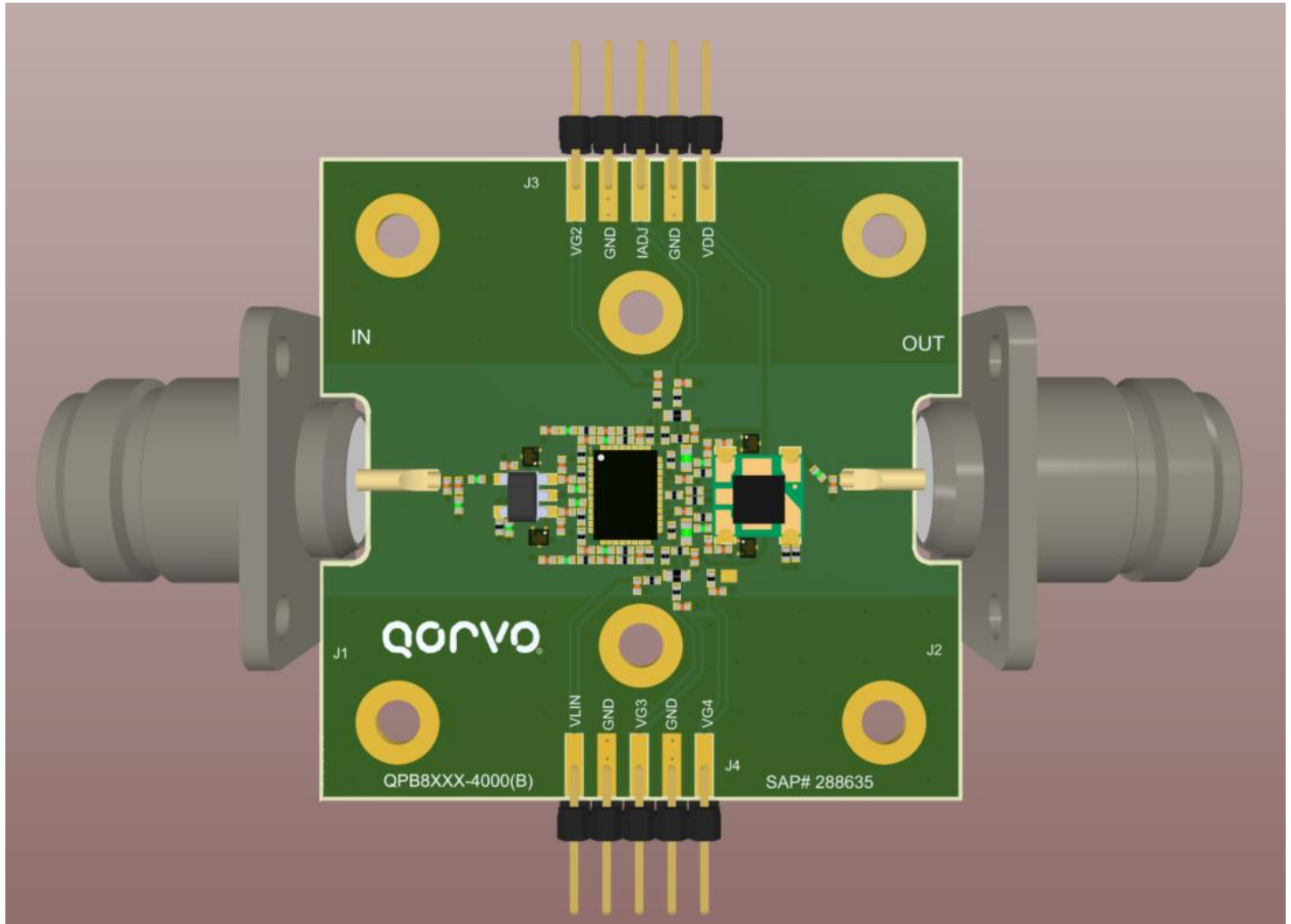

EVB PCB Material and Stack-up

Board Material: 0.030" FR4, $\epsilon_r=4.2$
 Plating: 1oz Copper
 Board Dimension: 1.9685" x 1.9685"

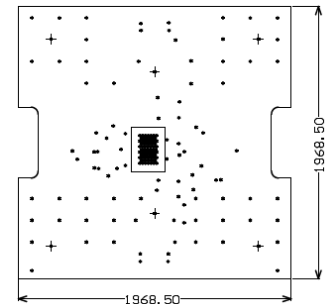
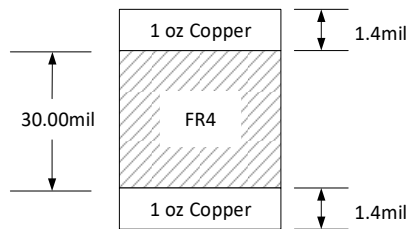

Evaluation Board Component Placement

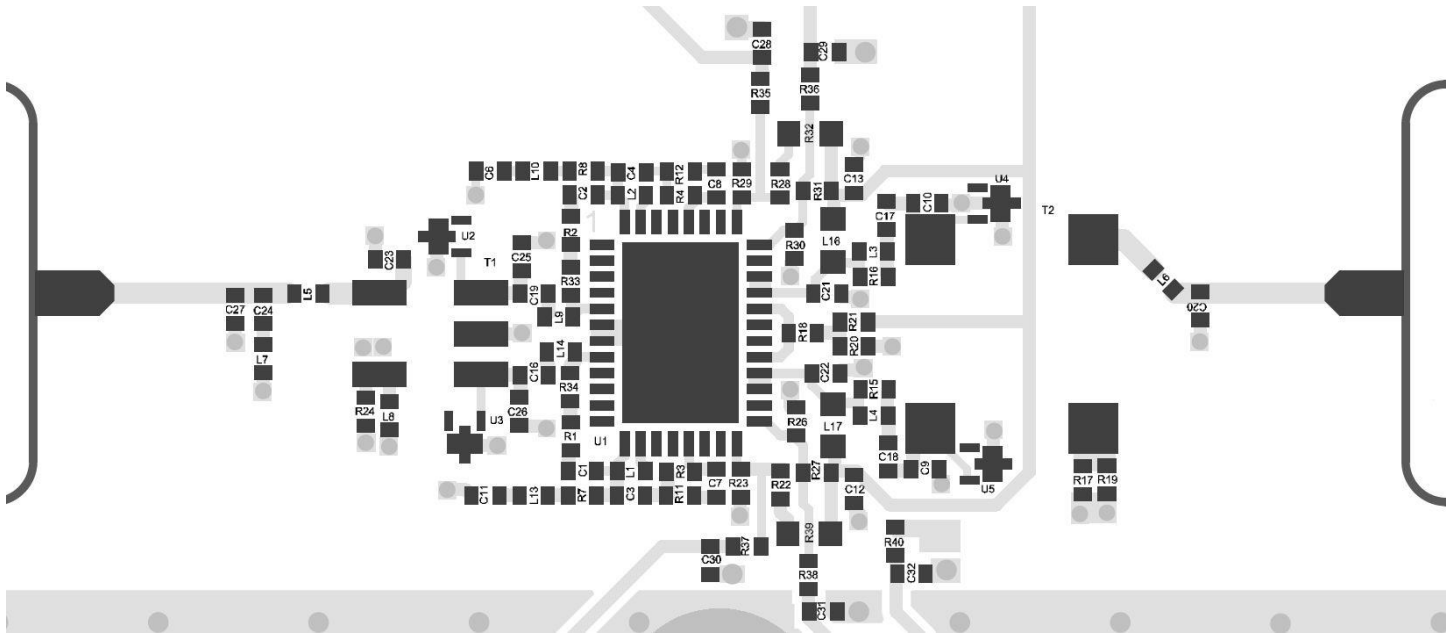

Typical Application Schematic; 24V

V

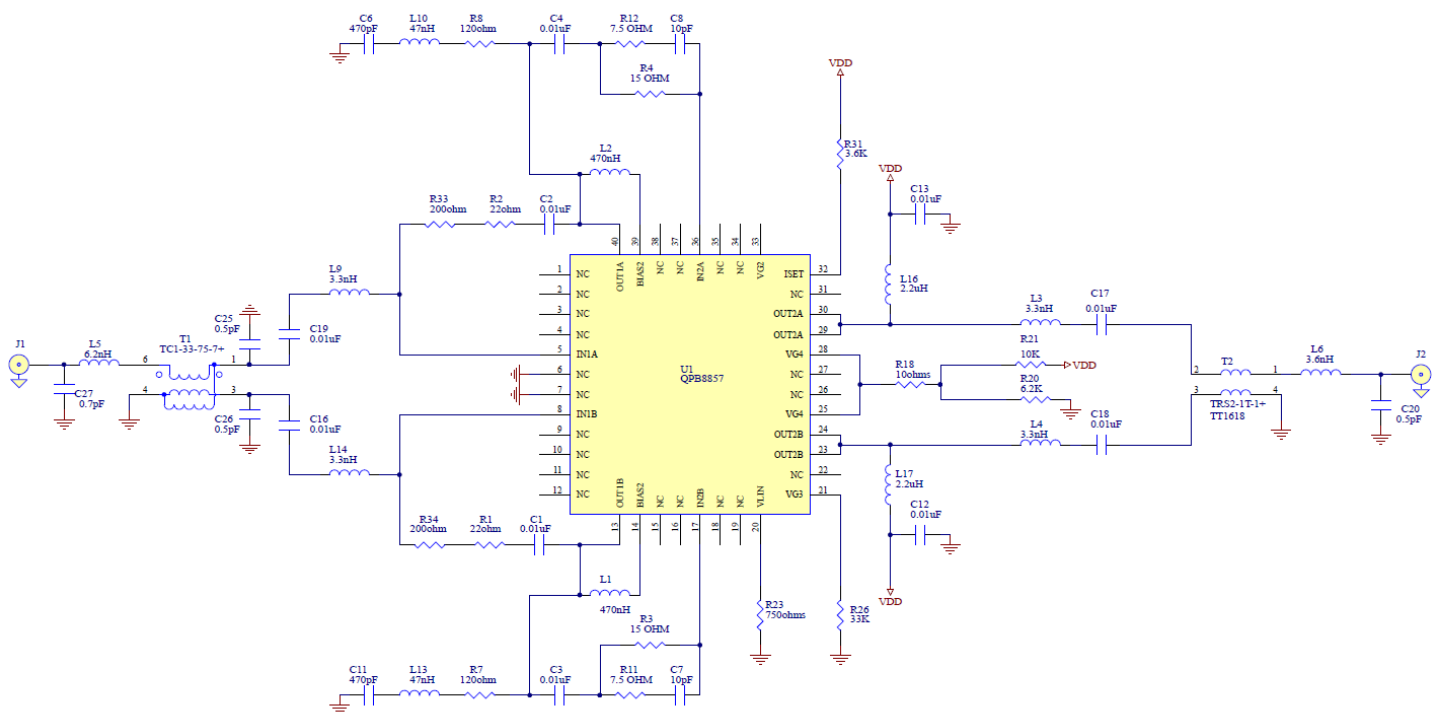

Performance Data 24V

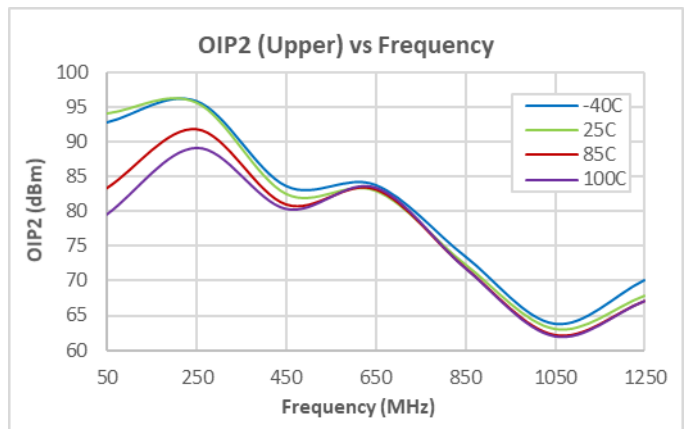
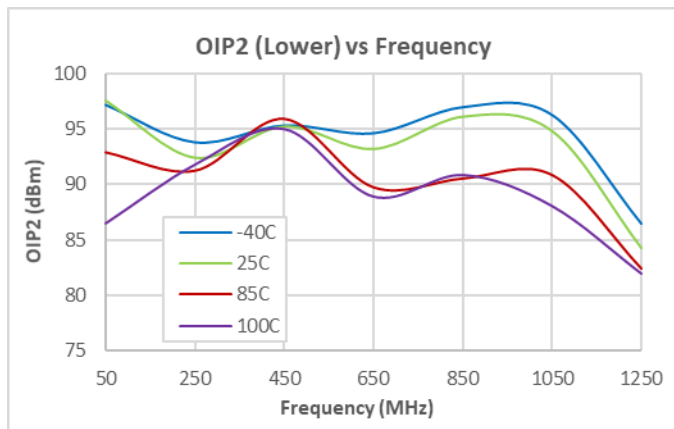
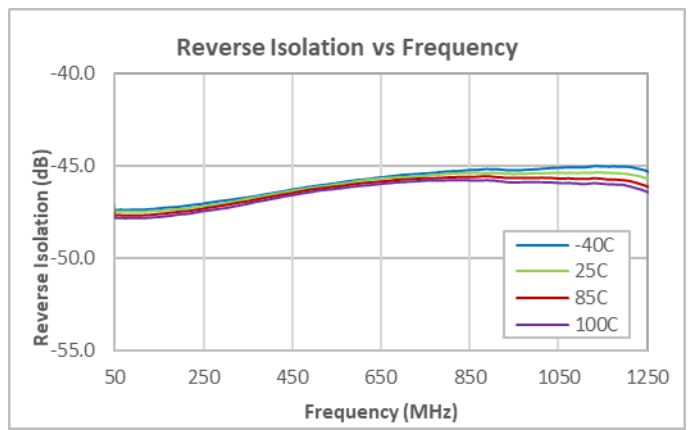
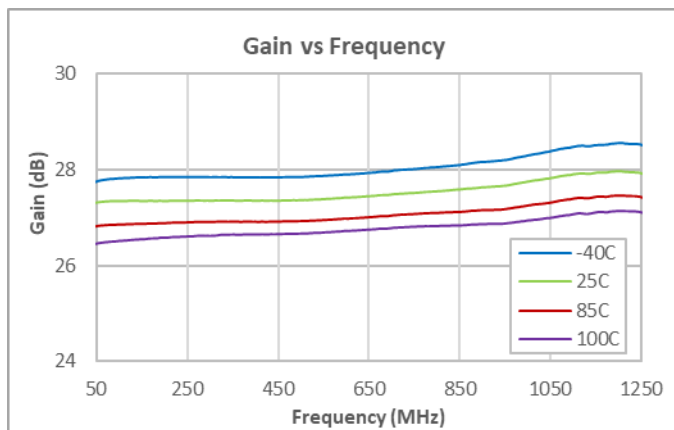
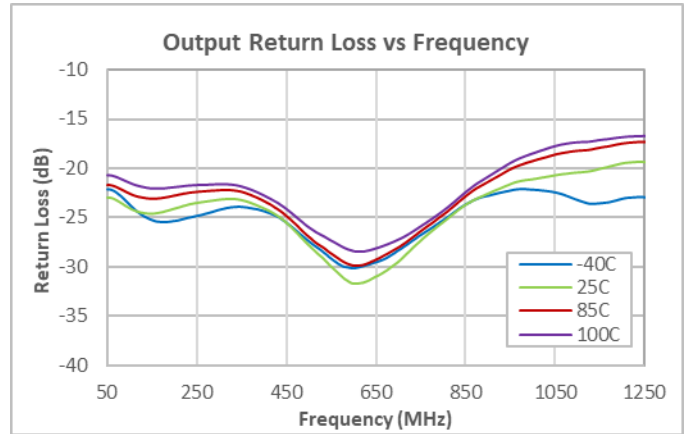
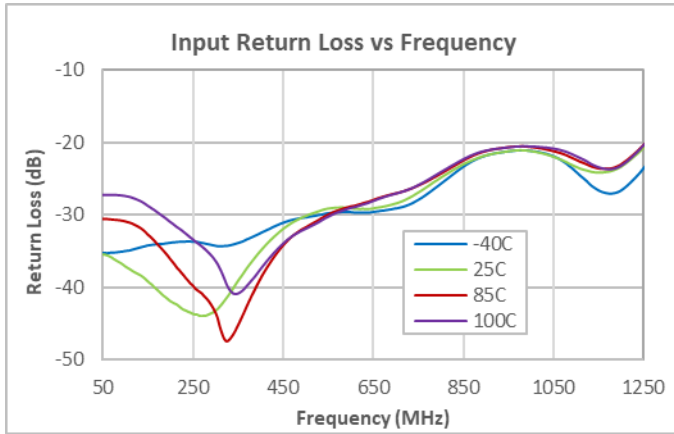

Test Conditions:

1. Test conditions unless otherwise noted: $V_{DD} = +24V$, $Z_0 = 75\Omega$
2. OIP2: +16dBm per Tone.

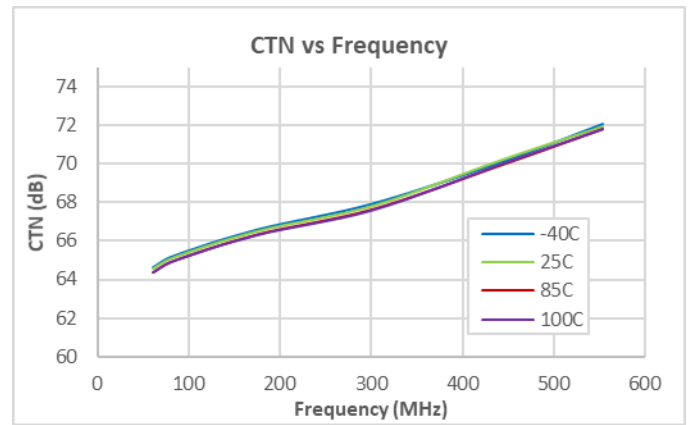
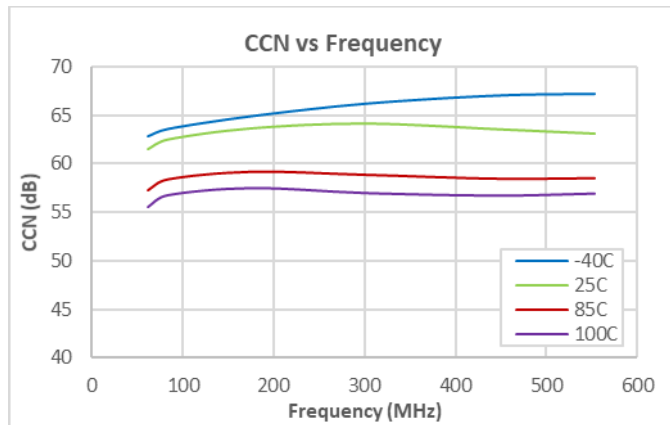
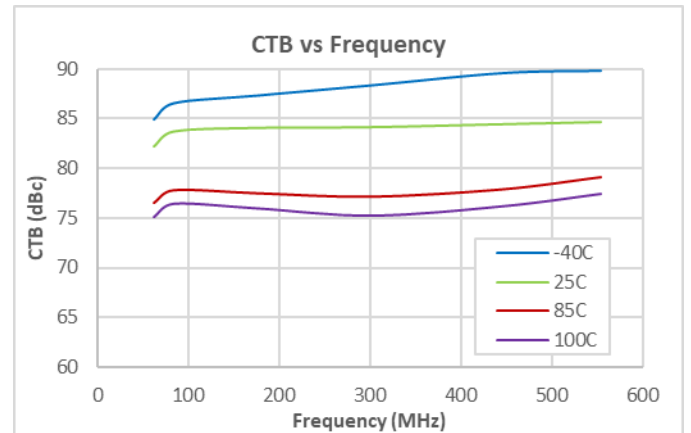
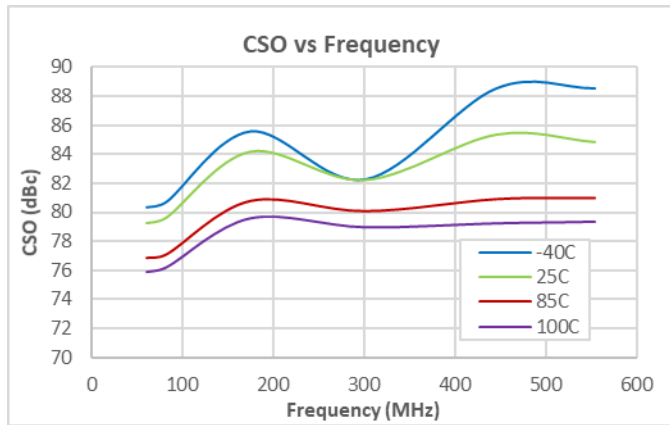
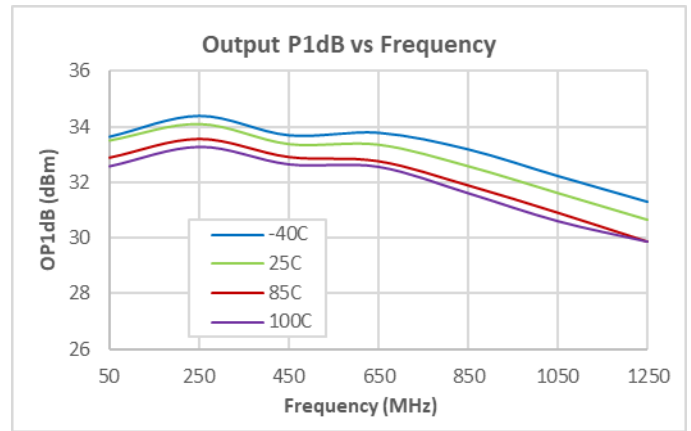
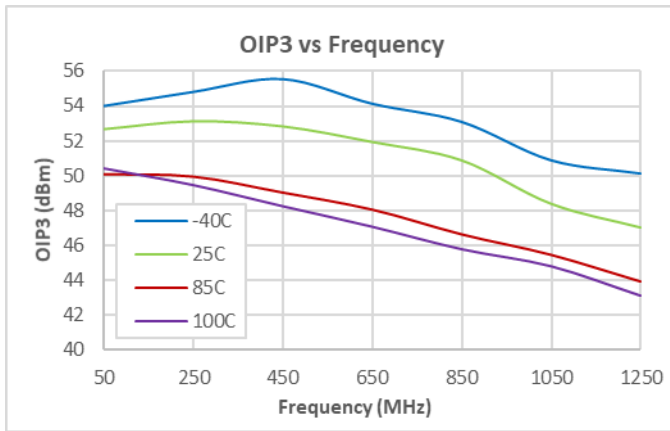
Performance Data 24V

Test Conditions:

1. Test conditions unless otherwise noted: $V_{DD} = +24V$, $Z_o = 75\Omega$
2. OIP3: +16dBm per Tone.
3. CSO, CTB, CCN, CTN: 80 NTSC + 111 QAM (-6dB offset), 57dBmV/ch out, 19dB tilt

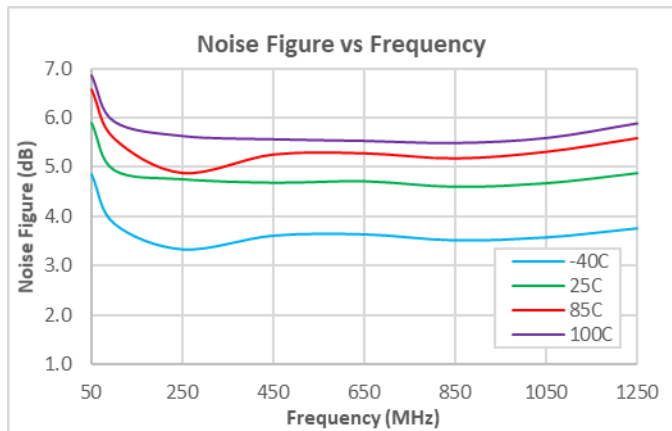
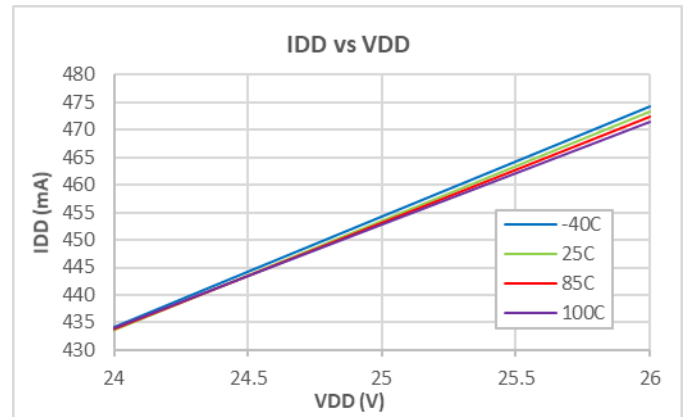
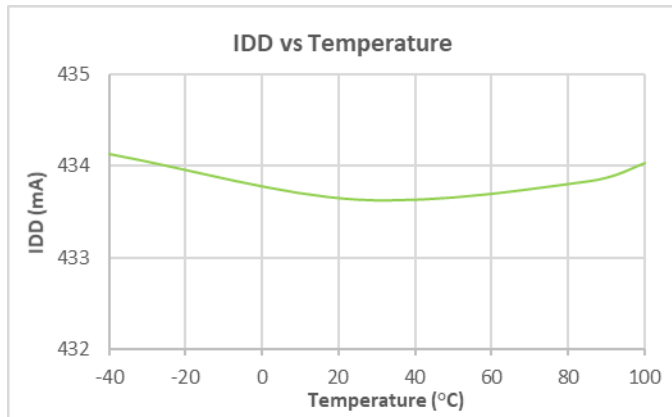
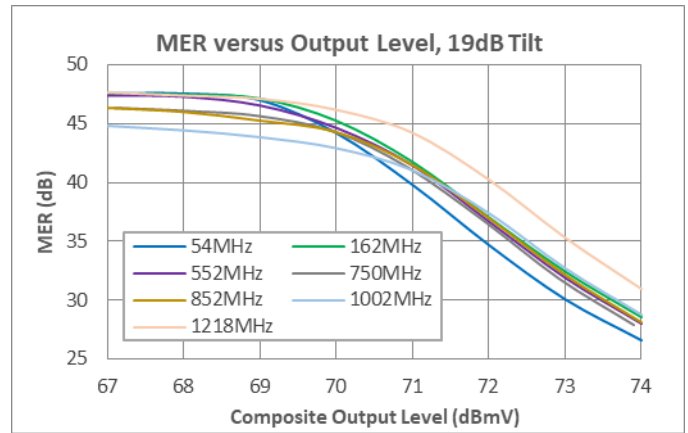
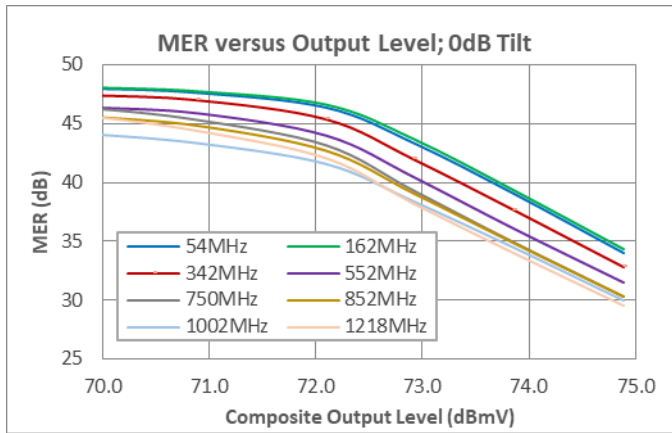
Performance Data 24V



Test Conditions:

1. Test conditions unless otherwise noted: $V_{DD} = +24V$, $Z_o = 75\Omega$
2. MER: 190 QAM256 Channels, 57-1215MHz, ITU-T J.83, Annex B

Pin Configuration and Description

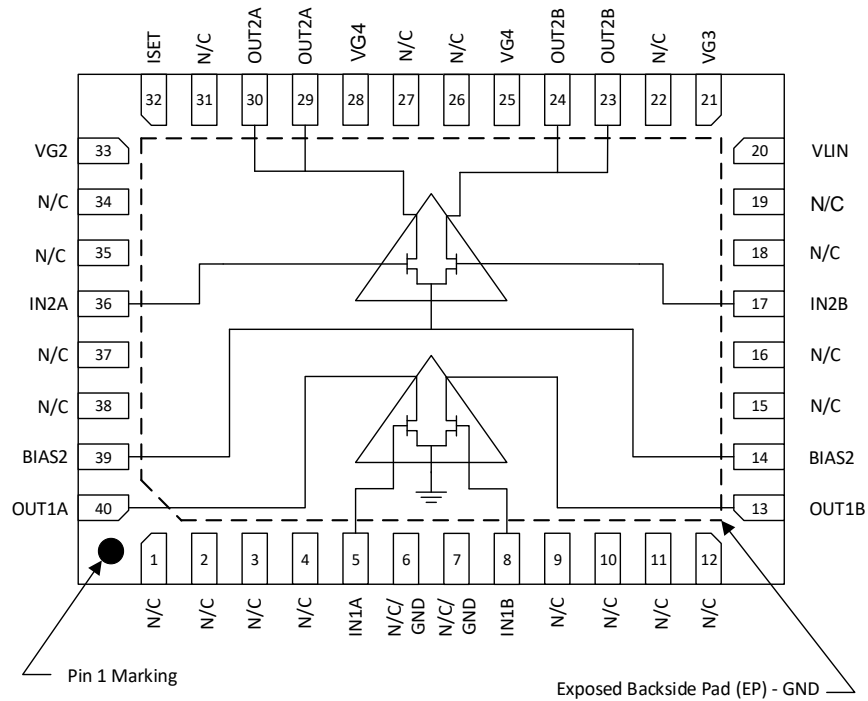

Top View

Pad No.	Label	Description
5	IN1A	RF input 1A
8	IN1B	RF input 1B
13	OUT1B	RF output 1B
14, 39	BIAS2	2nd Stage virtual ground
17	IN2B	RF input 2B
20	VLIN	Linearizer current set
21	VG3	VG3 adjust
23, 24	OUT2B	RF output 2B
25, 28	VG4	VG4 set
29, 30	OUT2A	RF output 2A
32	ISET	IDD set
33	VG2	No Connect
36	IN2A	RF input 2A
40	OUT1A	RF output 1A
1, 2, 3, 4, 9, 10, 11, 12, 15, 16, 18, 19, 22, 26, 27, 31, 34, 35, 37, 38	N/C	No Connect
6, 7	N/C/GND	No Connect or Ground
Backside Paddle	GND	Ground. Use recommended via pattern to minimize inductance and thermal resistance. See PCB Mounting Pattern for suggested footprint.

Package Outline

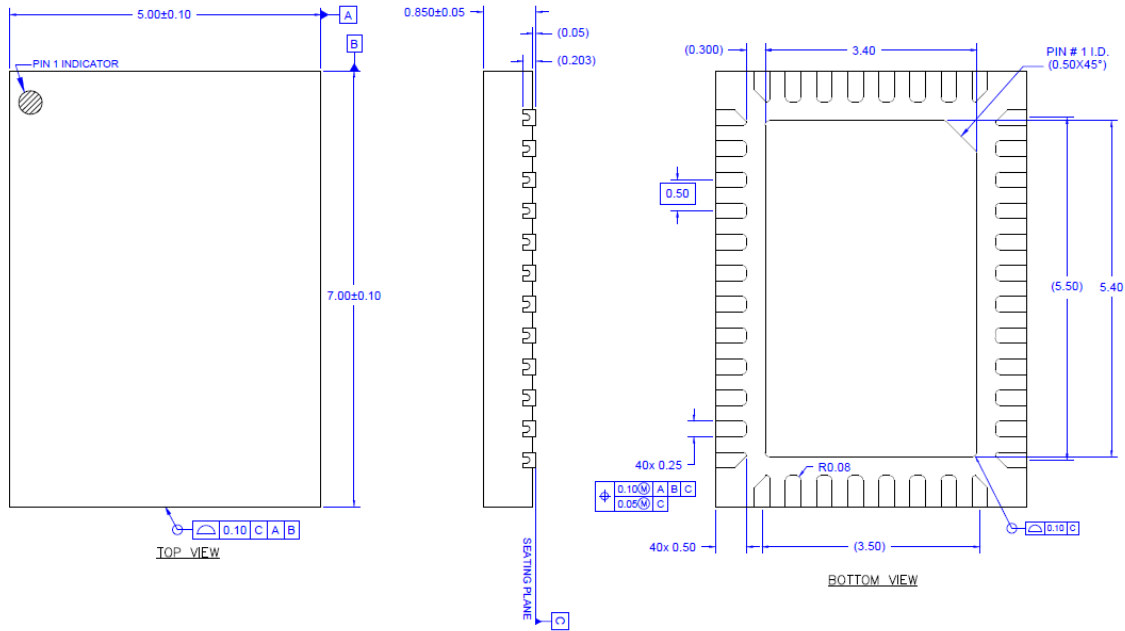

Notes:

1. Dimensions in millimeters

Package Marking

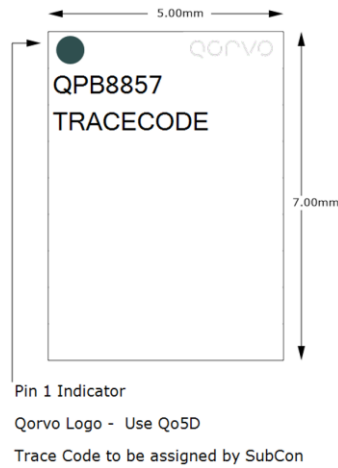

1. Dimension and tolerance formats conform to ASME Y14.4M-1994.
2. The terminal #1 identifier and terminal numbering conform to JESD 95-1 SPP-012.
3. Co-planarity applies to the exposed ground/thermal pad as well as the contact pins.
4. Package body length/width does not include plastic flash protrusion across mold parting line.

Recommended Mounting Pattern

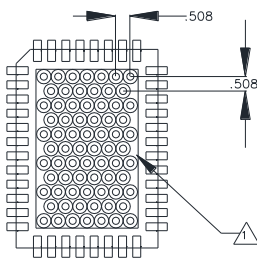

VIA PATTERN

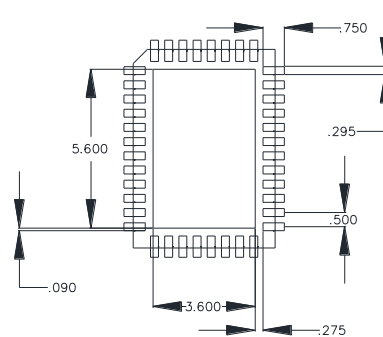

LAND PATTERN

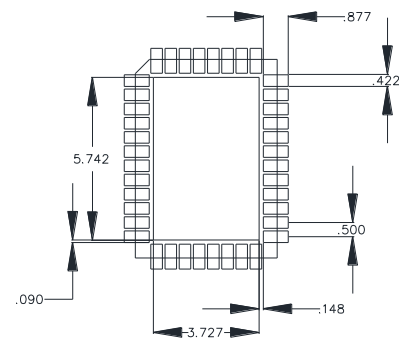

SOLDER MASK

NOTES:

1. GROUND/THERMAL VIAS AND MOUNTING HOLES ARE ESSENTIAL FOR THE PROPER DEVICE PERFORMANCE. DO NOT OMIT. VIAS SHOULD USE A .35mm (#80/.0135") DIAMETER DRILL AND HAVE A FINAL, PLATED THRU DIAMETER OF .25mm (.010").
2. TO ENSURE RELIABLE OPERATION, DEVICE GROUND PADDLE-TO-GROUND PAD SOLDER JOINT IS CRITICAL. NO SOLDER MASK ON BACKSIDE OF PCB IN HEAT SINK CONTACT AREA.
3. ALL DIMENSIONS ARE IN MILLIMETERS. ANGLES ARE IN DEGREES.

- Ensure good package backside paddle solder attach for reliable operation and best electrical performance.
- Place mounting screws near the part to fasten a back-side heat sink.
- Do not apply solder mask to the back side of the PC board in the heat sink contact region.
- Ensure that the backside via region makes good physical contact with the heat sink.

Handling Precautions

Parameter	Rating	Standard
ESD – Human Body Model (HBM)	1B (1000V)	ANSI / ESDA / JEDEC JS-001
ESD – Charged Device Model (CDM)	C3 (1000V)	ANSI / ESDA / JEDEC JS-002
MSL – Moisture Sensitivity Level	Level 3	IPC / JEDEC J-STD-020



Caution!
ESD-Sensitive Device

Solderability

Compatible with both lead-free (260°C max. reflow temp.) and tin/lead (245°C max. reflow temp.) soldering processes. Solder profiles available upon request.

Contact plating: NiPdAu

RoHS Compliance

This part is compliant with 2011/65/EU RoHS directive (Restrictions on the Use of Certain Hazardous Substances in Electrical and Electronic Equipment) as amended by Directive 2015/863/EU.

This product also has the following attributes:

- Lead Free
- Halogen Free (Chlorine, Bromine)
- Antimony Free
- TBBP-A (C₁₅H₁₂Br₄O₂) Free
- PFOS Free
- SVHC Free



Contact Information

For the latest specifications, additional product information, worldwide sales and distribution locations:

Tel: 1-844-890-8163

Web: www.qorvo.com

Email: customer.support@qorvo.com

Important Notice

The information contained in this Data Sheet and any associated documents (“Data Sheet Information”) is believed to be reliable; however, Qorvo makes no warranties regarding the Data Sheet Information and assumes no responsibility or liability whatsoever for the use of said information. All Data Sheet Information is subject to change without notice. Customers should obtain and verify the latest relevant Data Sheet Information before placing orders for Qorvo® products. Data Sheet Information or the use thereof does not grant, explicitly, implicitly or otherwise any rights or licenses to any third party with respect to patents or any other intellectual property whether with regard to such Data Sheet Information itself or anything described by such information.

DATA SHEET INFORMATION DOES NOT CONSTITUTE A WARRANTY WITH RESPECT TO THE PRODUCTS DESCRIBED HEREIN, AND QORVO HEREBY DISCLAIMS ANY AND ALL WARRANTIES WITH RESPECT TO SUCH PRODUCTS WHETHER EXPRESS OR IMPLIED BY LAW, COURSE OF DEALING, COURSE OF PERFORMANCE, USAGE OF TRADE OR OTHERWISE, INCLUDING THE IMPLIED WARRANTIES OF MERCHANTABILITY AND FITNESS FOR A PARTICULAR PURPOSE. Without limiting the generality of the foregoing, Qorvo® products are not warranted or authorized for use as critical components in medical, life-saving, or life-sustaining applications, or other applications where a failure would reasonably be expected to cause severe personal injury or death. Applications described in the Data Sheet Information are for illustrative purposes only. Customers are responsible for validating that a particular product described in the Data Sheet Information is suitable for use in a particular application.

© 2021 Qorvo US, Inc. All rights reserved. This document is subject to copyright laws in various jurisdictions worldwide and may not be reproduced or distributed, in whole or in part, without the express written consent of Qorvo US, Inc. | QORVO® is a registered trademark of Qorvo US, Inc.

Looking for pricing, stock, or lifecycle information?

Click below to explore more details on WIN SOURCE:

 [View QPB8857TR13 on WIN SOURCE](#)

 [Qorvo US Inc. Information](#)

Optimize Your Supply Chain with WIN SOURCE Solutions

-  Global Sourcing Solution
-  Obsolete Management
-  Cost Control Management
-  Shortage Management
-  Alternative Solution
-  Excess Inventory Management