



**THE DATASHEET OF
QPA2628TR7**



Product Description

Qorvo's QPA2628 is a packaged, high-performance, low noise amplifier fabricated on Qorvo's production 90nm pHEMT (QPHT09) process. Covering 22 – 31.5 GHz, the QPA2628 provides 23 dB small signal gain and P1dB of 19 dBm, while supporting a noise figure of 1.6 dB and IM3 levels of -54 dBc (at Pout=0 dBm/tone).

Packaged in a small 4 mm x 4 mm plastic overmold QFN, the QPA2628 is matched to 50 ohms with integrated DC blocking caps on both I/O ports for easy handling and simple system integration.

The QPA2628 high performance and ease of handling make it ideal for satellite and military or commercial radar applications.

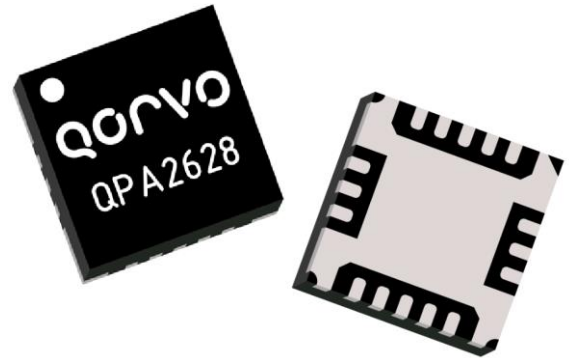

Product Features

- Frequency Range: 22 – 31.5 GHz
- Noise Figure: 1.6 dB
- Small Signal Gain: 23 dB
- P1dB: 19 dBm
- IM3: -54 dBc (@ Pout=0 dBm/tone)
- Bias: $V_D = 3.5\text{ V}$, $I_{DQ} = 90\text{ mA}$, $V_G = -0.46\text{ V}$
- Plastic Overmolded Package
- Package Dimensions: 4.0 x 4.0 x 0.85 mm

Performance is typical across frequency. Please reference electrical specification table and data plots for more details.

Applications

- Satellite Communications
- Military and Commercial Radar Applications

Functional Block Diagram

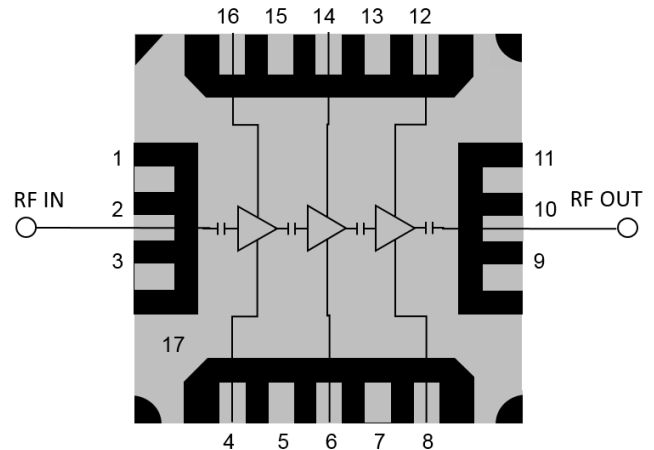

Ordering Information

Part	Description
QPA2628	22 – 31.5 GHz GaAs Low Noise Amplifier
QPA2628TR7	Tape & Reel, 7" Short Reel, Qty 500
QPA2628EVB1	QPA2628 Evaluation Board, Qty 1

Absolute Maximum Ratings

Parameter	Value	Units
Drain Voltage (V_D)	4.5	V
Drain Current ($I_{D1}/I_{D2}/I_{D3}$)	45/45/160	mA
Gate Voltage Range	-1.3 to 0	V
Gate Current ($I_{G1}/I_{G2}/I_{G3}$ at 125 °C)	5.0/5.0/6.6	mA
RF Input Power (50 Ω , 85 °C)	20	dBm
Channel Temperature, T_{CH}	175	°C
Mounting Temperature (30 seconds)	260	°C
Storage Temperature	-55 to 150	°C

Operation of this device outside the parameter ranges given above may cause permanent damage. These are stress ratings only, and functional operation of the device at these conditions is not implied.

Recommended Operating Conditions

Parameter	Value	Units
Drain Voltage	3.5	V
Drain Current (quiescent, I_{DQ})	90	mA
Drain Current (I_D , Low noise / P_{SAT})	90 / 175	mA
Gate Voltage (typical)	-0.46	V
Operating Temperature Range	-40 to 85	°C

Electrical specifications are measured at specified test conditions. Specifications are not guaranteed over all recommended operating conditions.

Electrical Specifications

Test conditions, unless otherwise noted: 25 °C, $V_D = 3.5$ V, $I_{DQ} = 90$ mA. Data de-embedded to device reference plane.

Parameter	Min	Typical	Max	Units
Frequency	22		31.5	GHz
Small Signal Gain	19	23		dB
Noise Figure		1.6		dB
1-dB Compression Point		19		dBm
Input Return Loss		11		dB
Output Return Loss		16		dB
3 RD Order Intermodulation level ($P_{out}=0$ dBm/tone)		-54		dBc
Output TOI ($P_{out}=0$ dBm/tone)		27		dBm
Gain Temperature Coefficient		-0.013		dBm/°C

Performance Plots – Small Signal

Test conditions unless otherwise noted: Temp. = 25 °C, $V_D = 3.5$ V, $I_{bq} = 90$ mA.

Input Return Loss vs Temperature

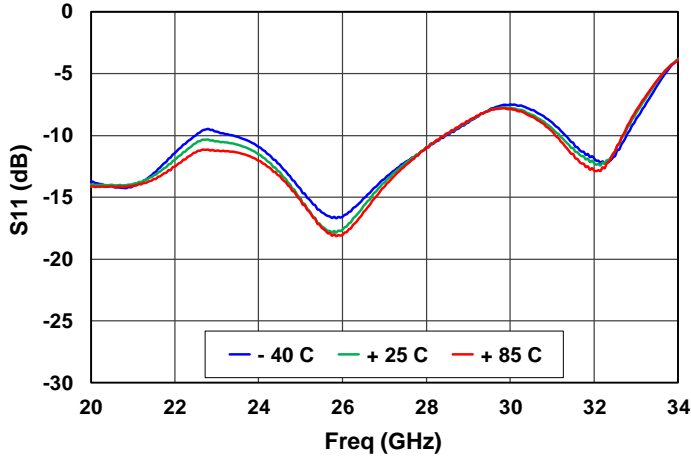

Gain vs Temperature

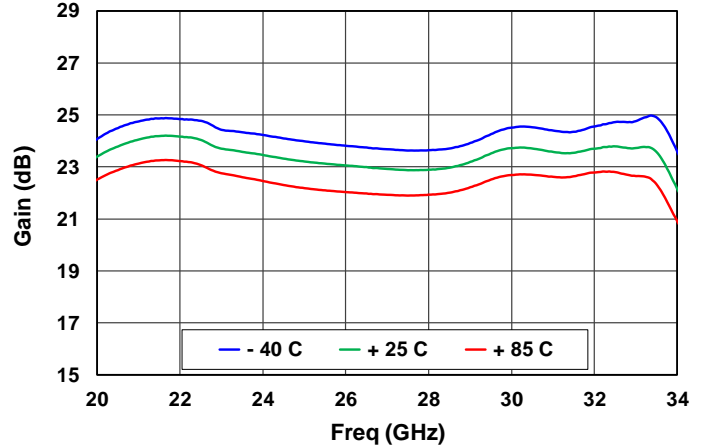

Reverse Isolation vs Temperature

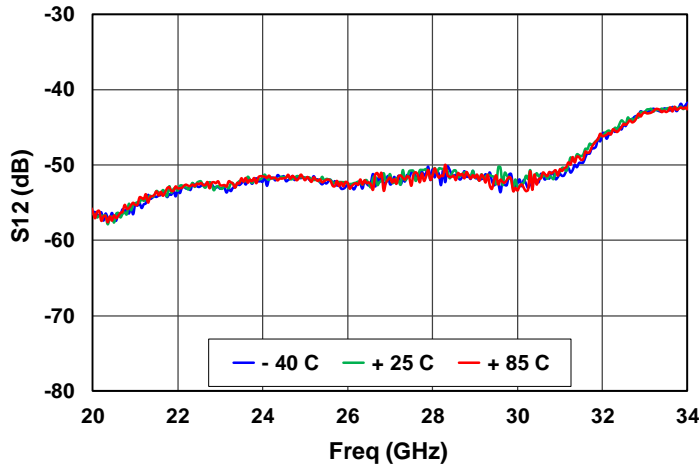

Output Return Loss vs Temperature

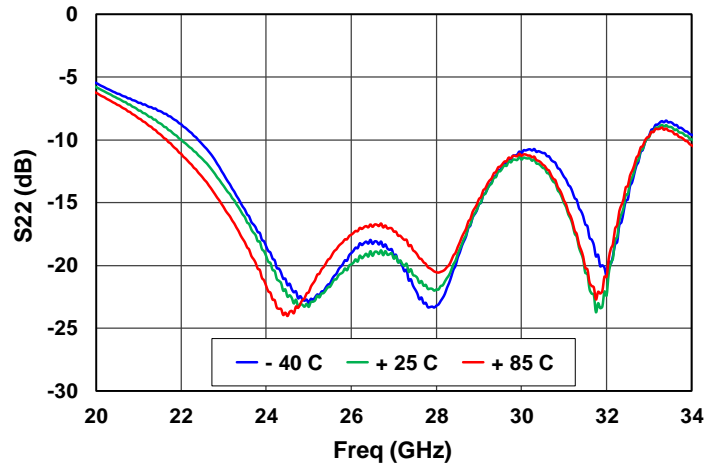

Performance Plots – Small Signal

Test conditions unless otherwise noted: Temp. = 25 °C, $V_D = 3.5\text{ V}$, $I_{DQ} = 90\text{ mA}$.

Gain vs Voltage

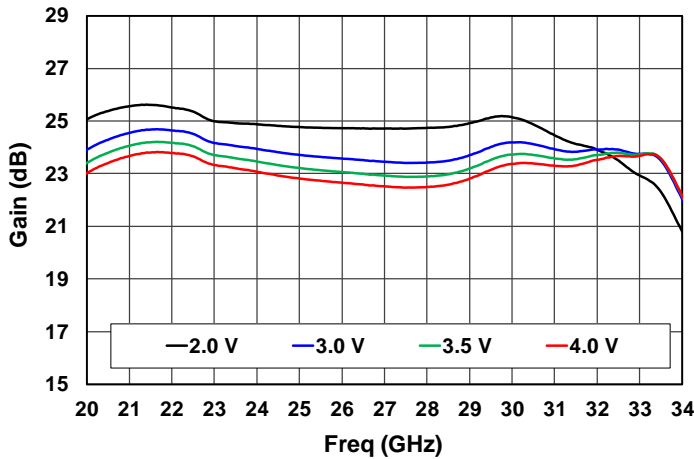

Gain vs Current

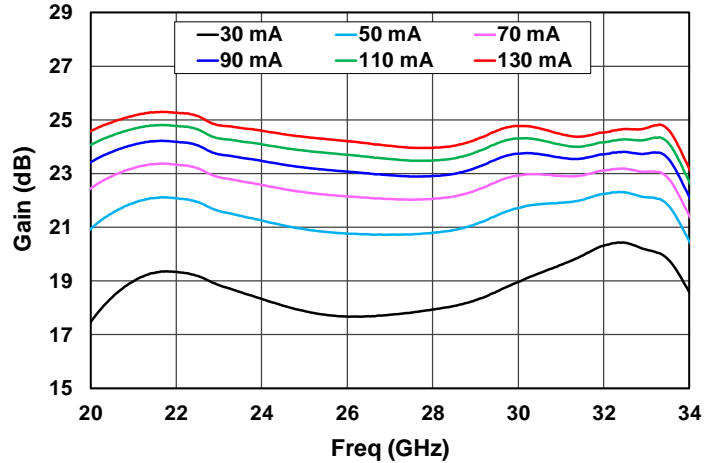

Input Return Loss vs Voltage

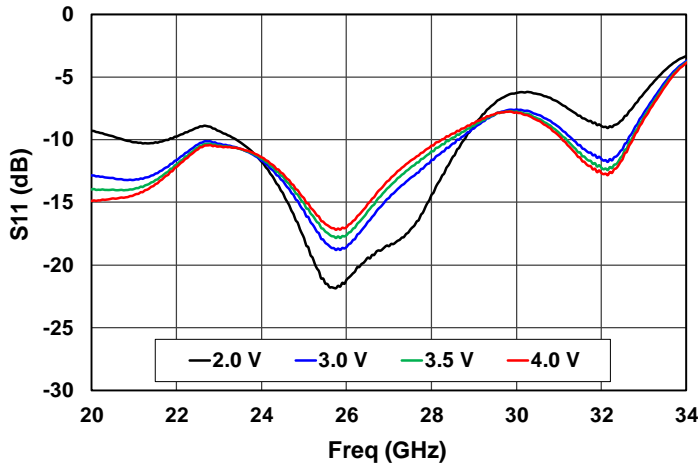

Input Return Loss vs Current

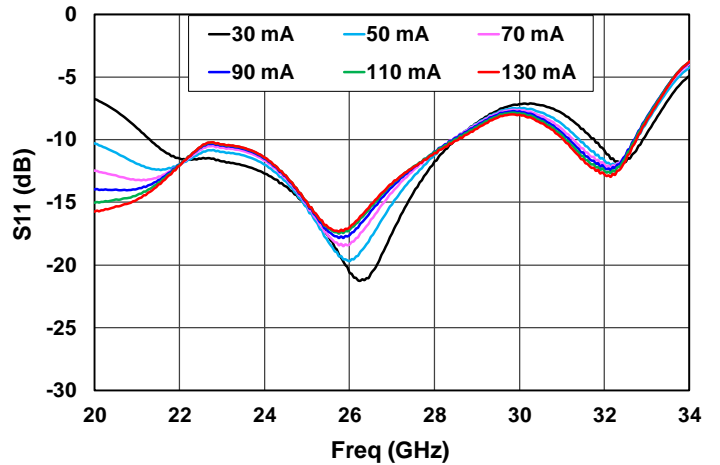

Output Return Loss vs Voltage

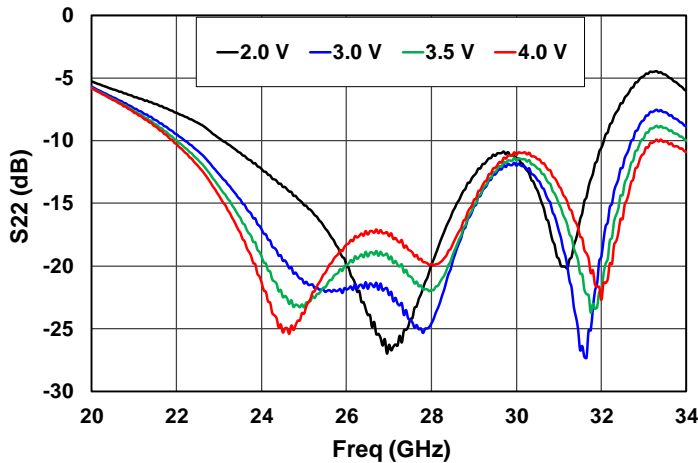

Output Return Loss vs Current

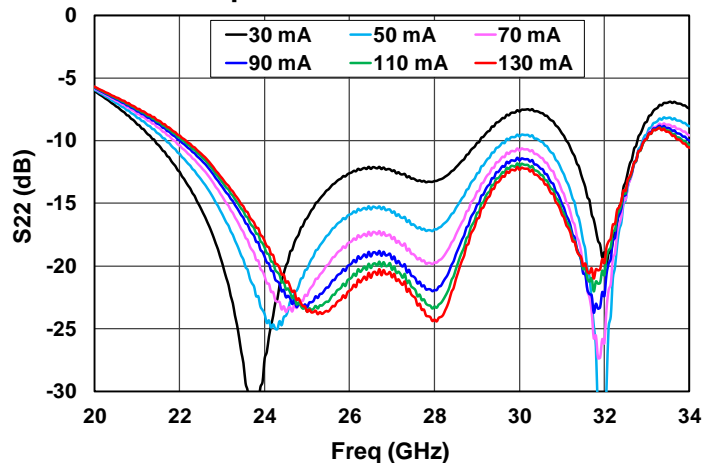

Performance Plots – Noise Figure

Test conditions unless otherwise noted: Temp. = 25 °C, $V_D = 3.5$ V, $I_{bq} = 90$ mA.

NF vs Temperature

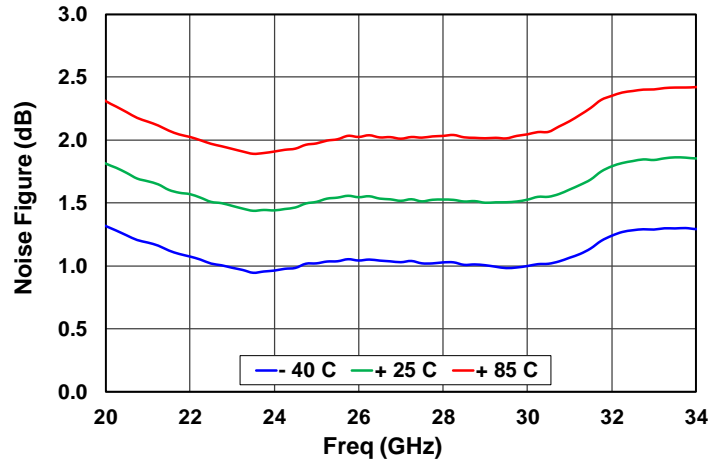

NF vs Voltage

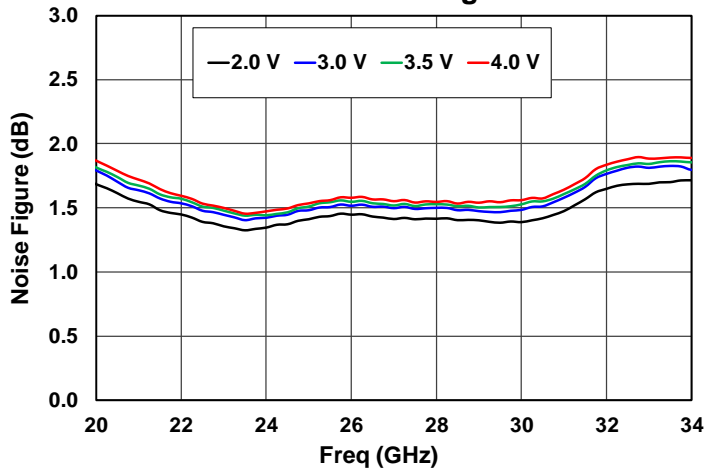

NF vs Current

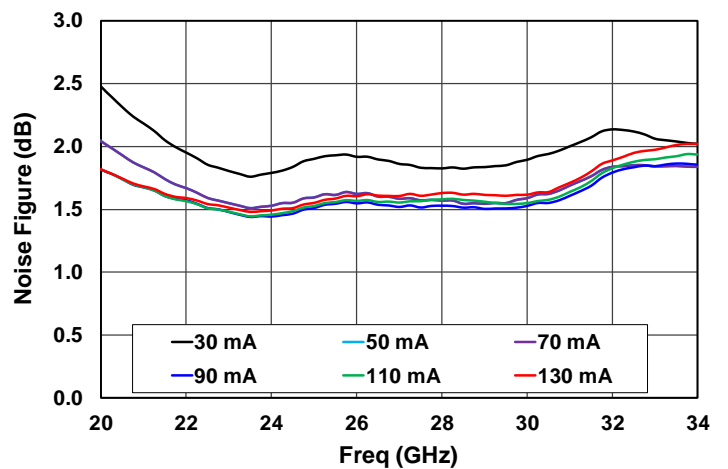

Performance Plots: Large Signal

Test conditions unless otherwise noted: Temp. = 25 °C, $V_D = 3.5$ V, $I_{DQ} = 90$ mA.

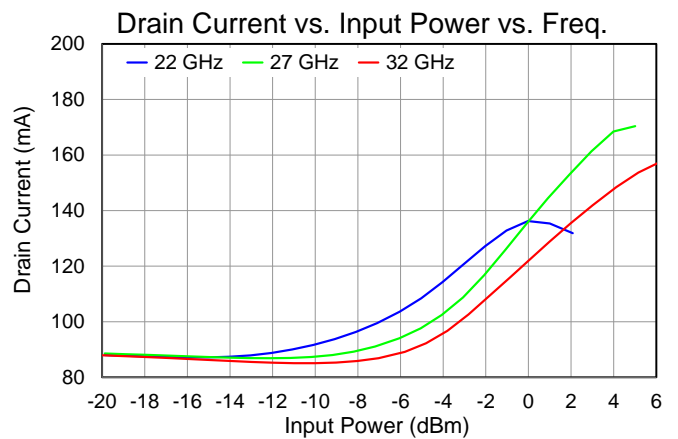
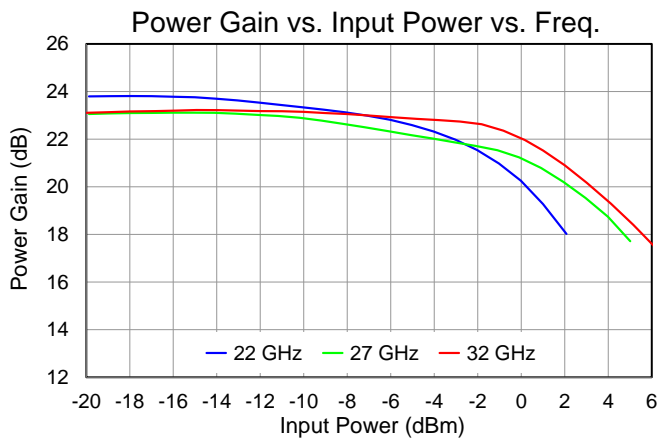
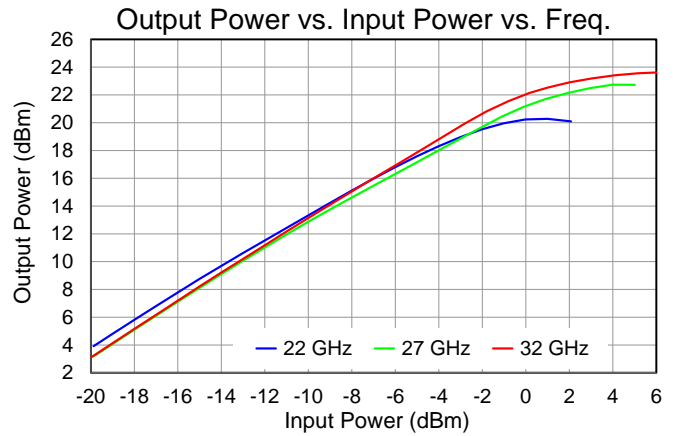
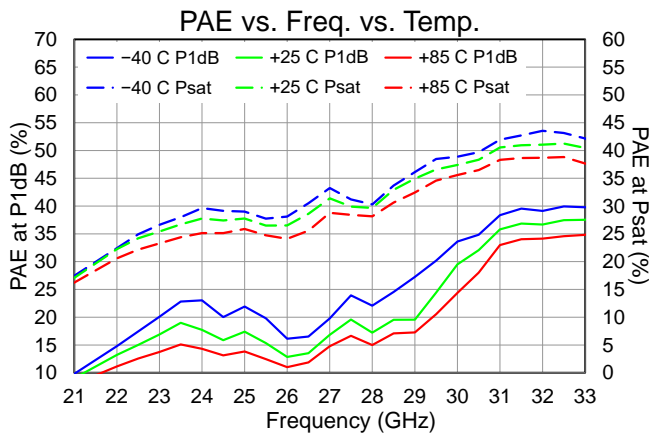
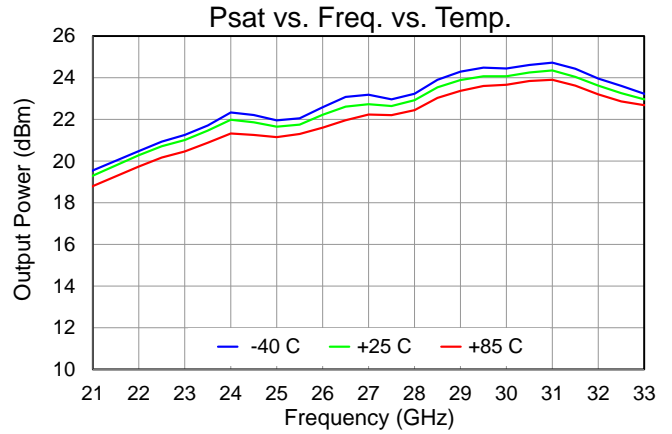
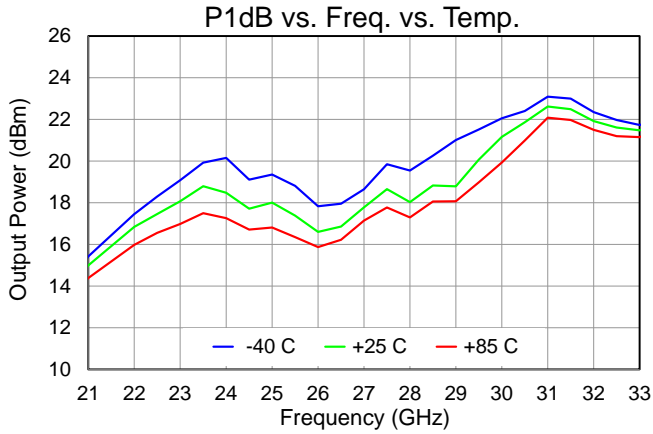

Performance Plots: Linearity

Test conditions unless otherwise noted: Temp. = 25 °C, $V_D = 3.5$ V, $I_{DQ} = 90$ mA.

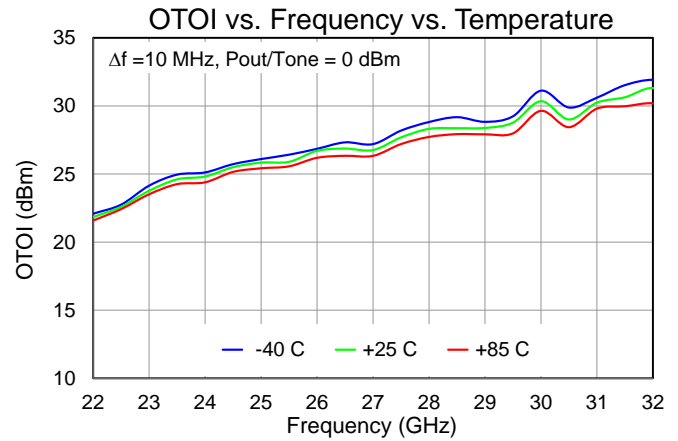
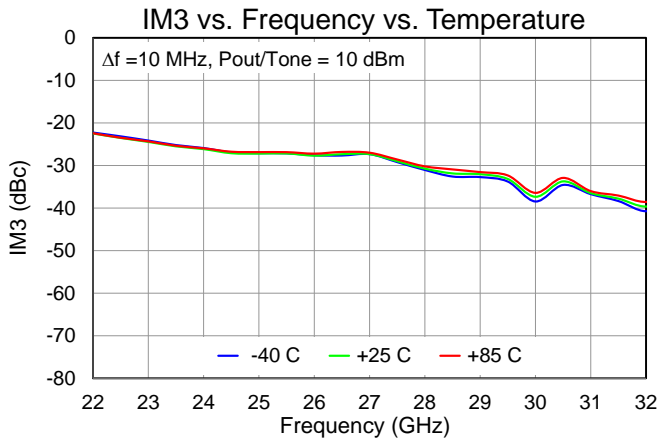
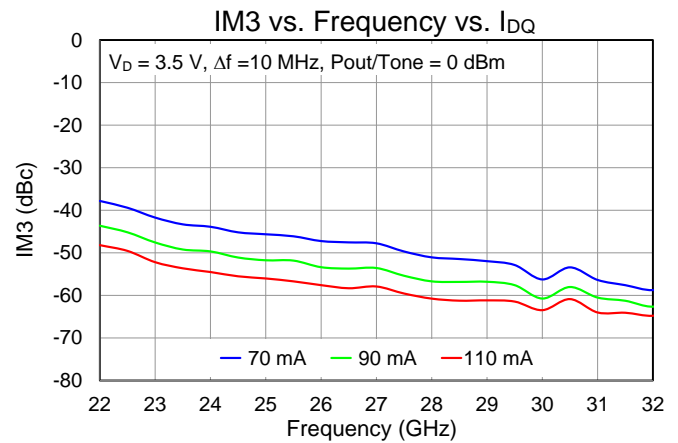
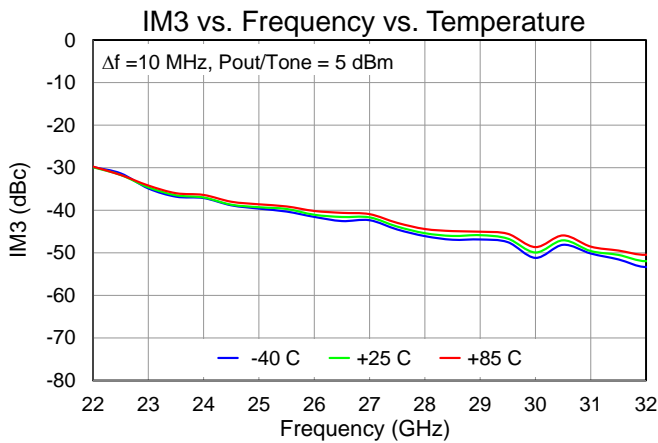
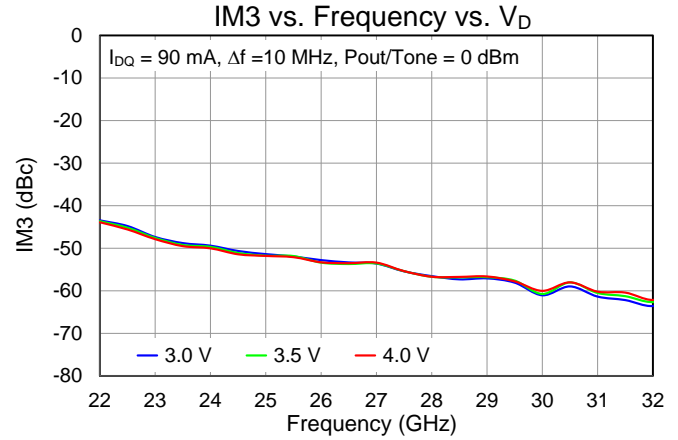
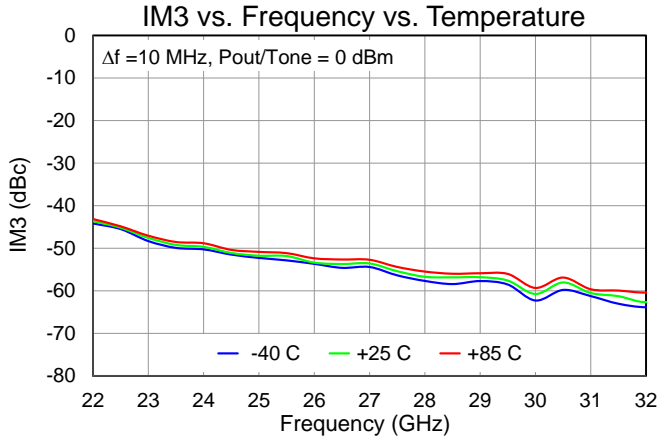

Performance Plots: Linearity

Test conditions unless otherwise noted: Temp. = 25 °C, $V_D = 3.5$ V, $I_{DQ} = 90$ mA.

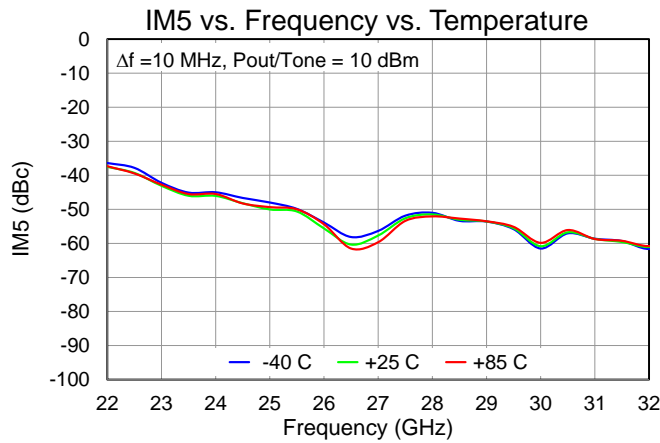
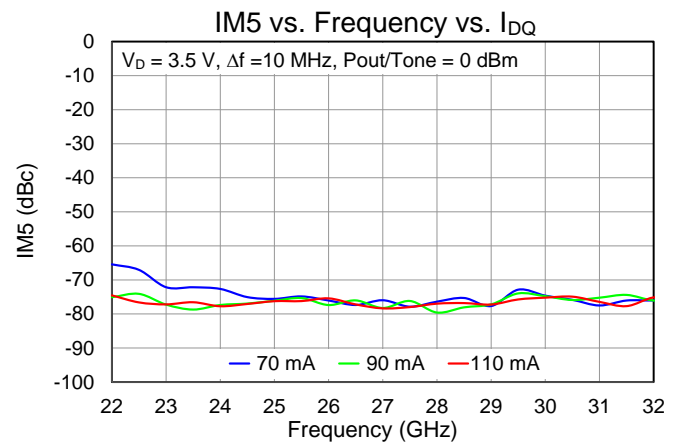
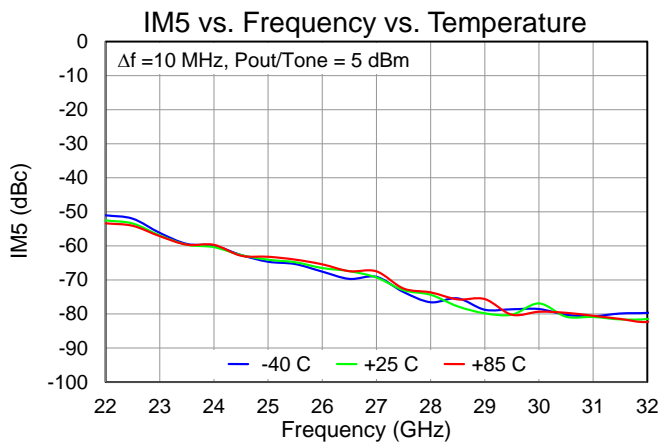
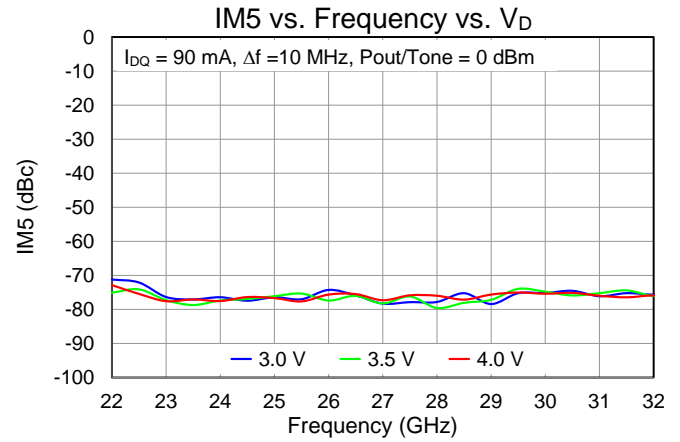
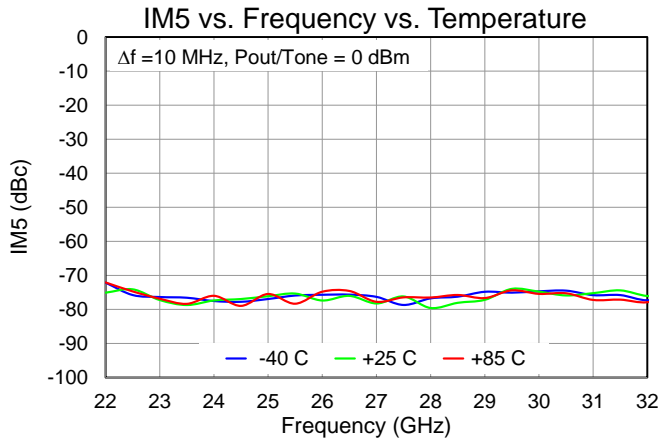

Applications Circuit

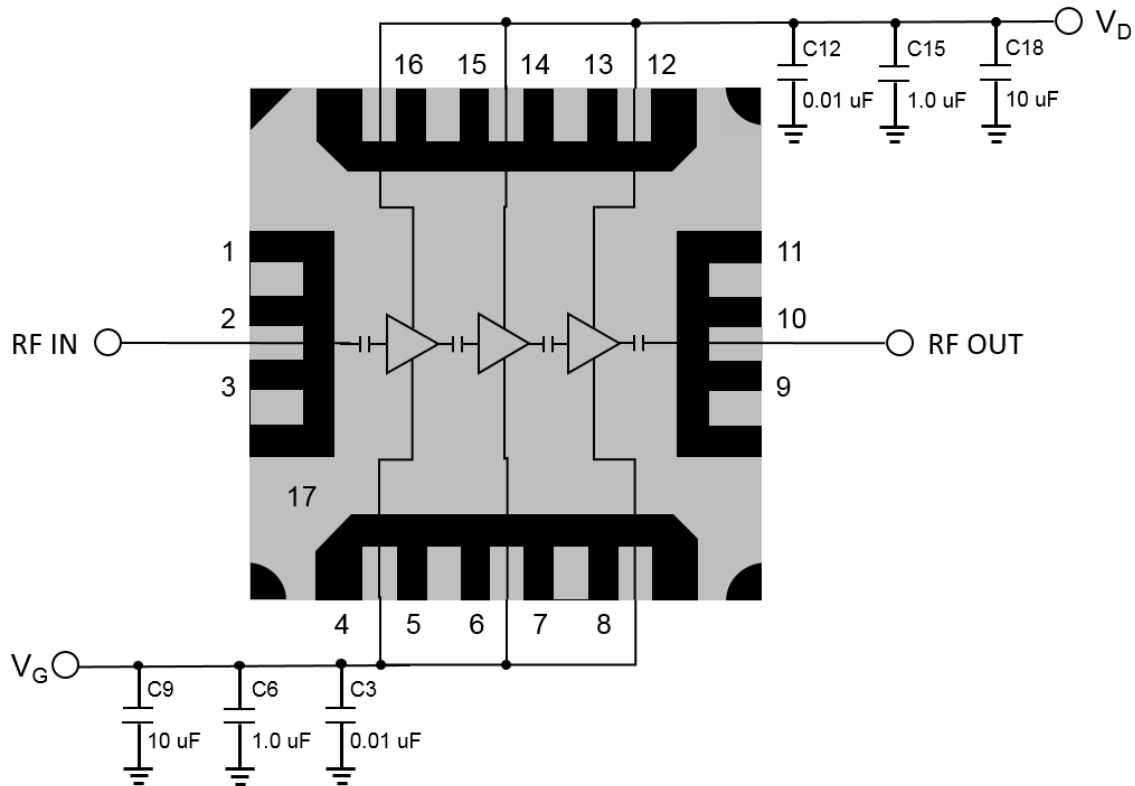

Bias Up Procedure

1. Set I_D limit to 200 mA, I_G limit to 10 mA
2. Set V_G to -1.3 V
3. Set V_D +3.5 V
4. Adjust V_G more positive until $I_{DQ} = 90$ mA
($V_G \sim -0.46$ V Typical)
5. Apply RF signal

Bias Down Procedure

1. Turn off RF signal
2. Reduce V_G to -1.3 V. Ensure $I_{DQ} \sim 0$ mA
3. Set V_D to 0V
4. Turn off V_D supply
5. Turn off V_G supply

Evaluation Board and Mounting Detail

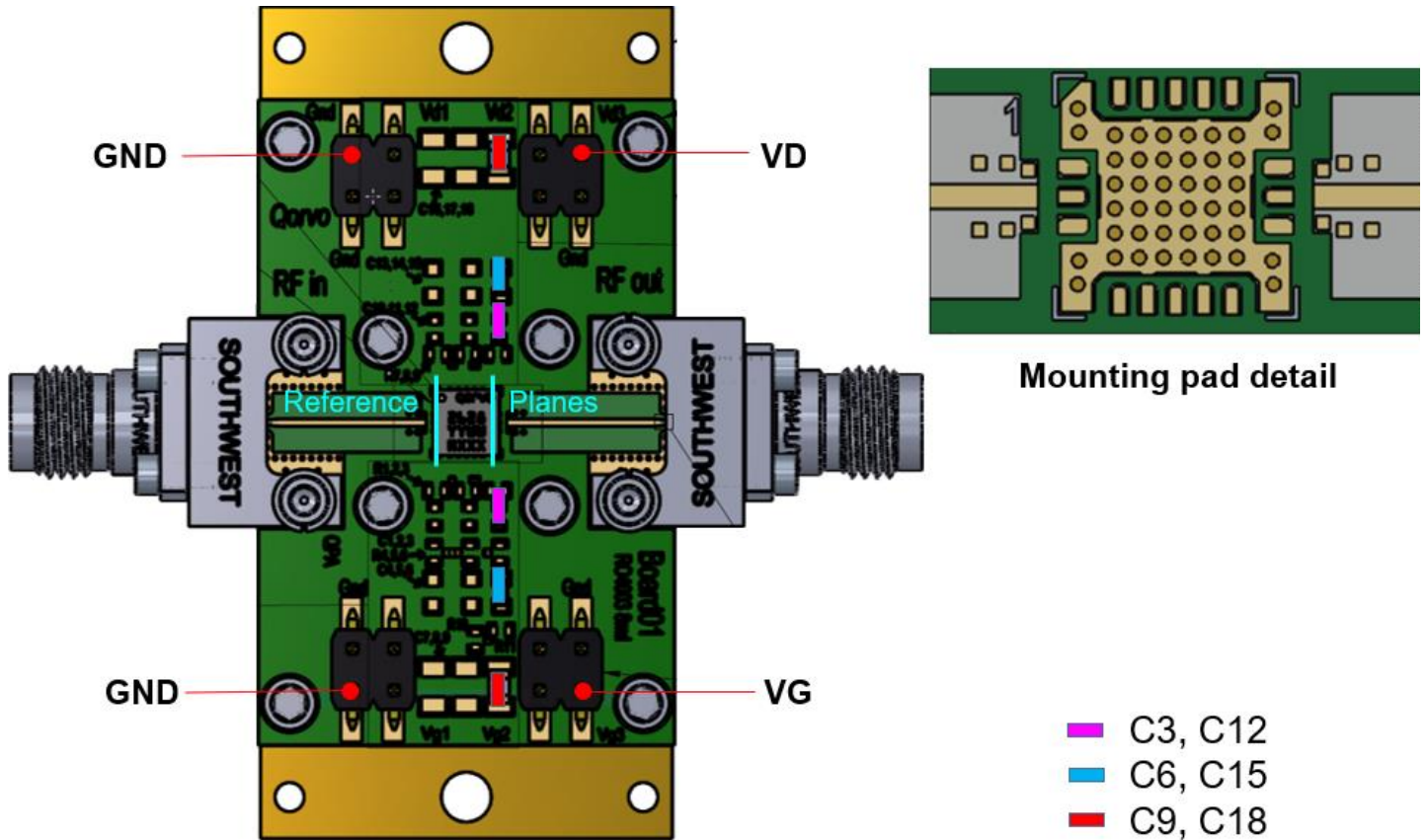

RF Layer is 0.008" thick Rogers Corp. RO4003C ($\epsilon_r = 3.35$). Metal layers are 0.5 oz. copper. The microstrip line at the connector interface is optimized for the Southwest Microwave end launch connector 1492-04A-5.

All data de-embedded to the device reference plane (shown).

Ref. Des.	Component	Value	Manuf.	Part Number
C3, C12	Surface Mount Cap.	CAP 0.01UF +/-10% 50V 0402 X7R ROHS	Various	
C6, C15	Surface Mount Cap.	CAP 1.0UF +/-10% 16V 0603 X7R ROHS	Various	
C9, C18	Surface Mount Cap.	CAP CER 10UF 10V X7R 10% 0805 TDK ROHS	Various	
RF IN, RF OUT	RF Connectors	2.4 MM END LAUNCH CONNECTOR	Southwest Microwave	1492-04A-5

Mechanical Drawing & Pad Description

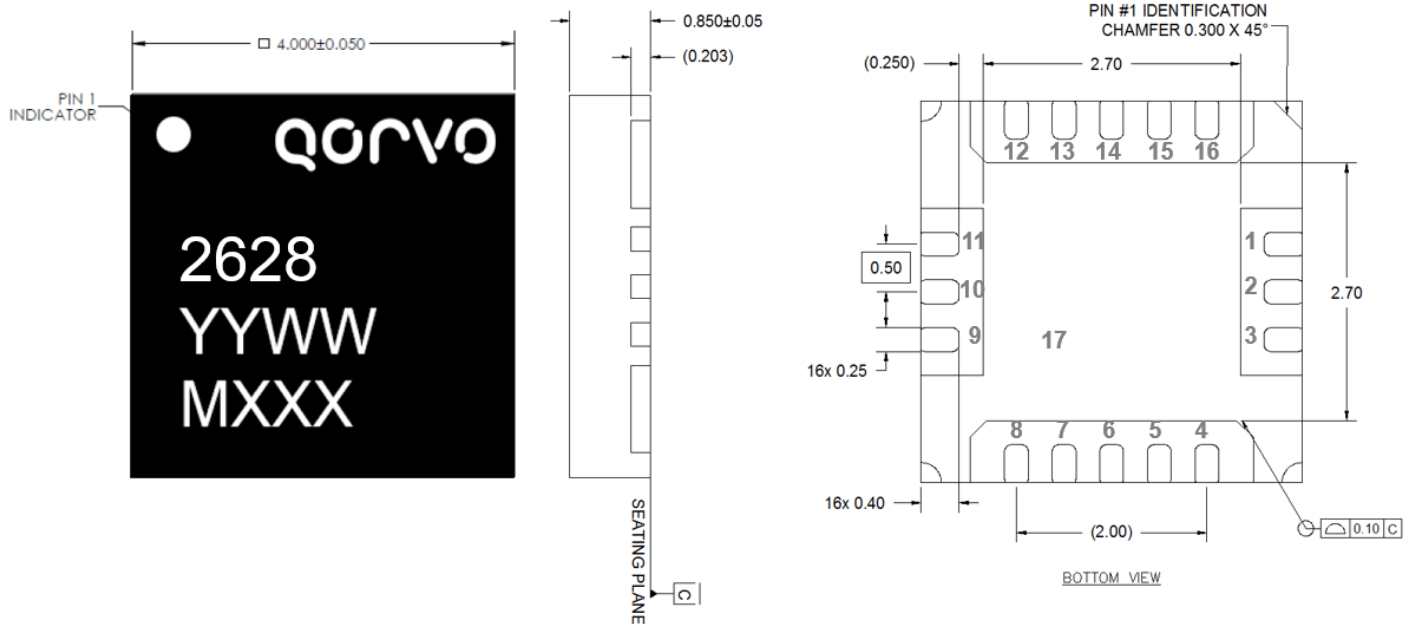

Dimensions in mm, package is mold encapsulated with NiPdAu plated leads

Part Marking: 2628: Part Number; YY = Part Assembly Year; MM = Part Assembly Month; MXXX = Batch ID

Pin Number	Label	Description
1, 3, 9, 11, 17 (slug)	GND	GROUND
2	RF Input	Matched to 50 ohms, DC blocked
4	VG1	Gate Voltage; bias network is required (V_G can be tied together at PCB)
6	VG2	Gate Voltage; bias network is required (V_G can be tied together at PCB)
8	VG3	Gate Voltage; bias network is required (V_G can be tied together at PCB)
10	RF Output	Matched to 50 ohms, DC blocked
12	VD3	Drain Voltage; bias network is required (V_D can be tied together at PCB)
14	VD2	Drain Voltage; bias network is required (V_D can be tied together at PCB)
16	VD1	Drain Voltage; bias network is required (V_D can be tied together at PCB)
5, 7, 13, 15	N/C	No internal connection. Recommend to GND at the PCB level

Thermal and Reliability Information

Parameter	Test Conditions	Value	Units
Thermal Resistance (θ_{JC}) ⁽¹⁾	$T_{base} = 85^{\circ}C$, $V_D = 3.5 V$, $I_{DQ} = 90 mA$ Quiescent/Small Signal operation $P_{DISS} = 0.315 W$	65.1	$^{\circ}C/W$
Channel Temperature (T_{CH})		105.5	$^{\circ}C$
Median Lifetime (T_M)		1.236E08	Hrs

Notes:

1. Thermal resistance is measured to back of the package.

Median Lifetime

Test Conditions: $V_D = 4 V$
 Failure Criteria = 10% reduction in I_{D_MAX}

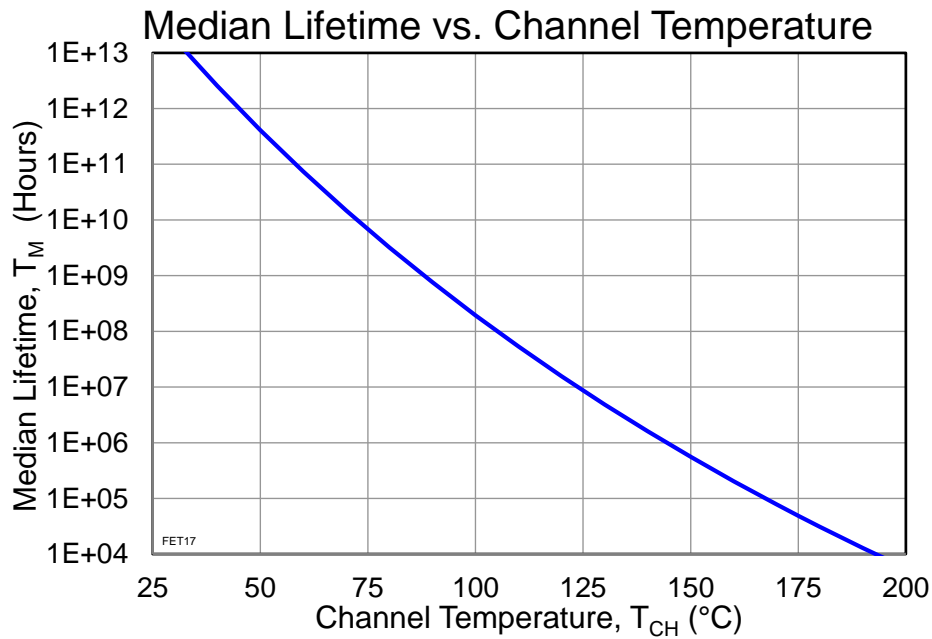

Solderability

1. Compatible with the latest version of J-STD-020, Lead-free solder, 260 °C peak reflow temperature.

Recommended Soldering Temperature Profile

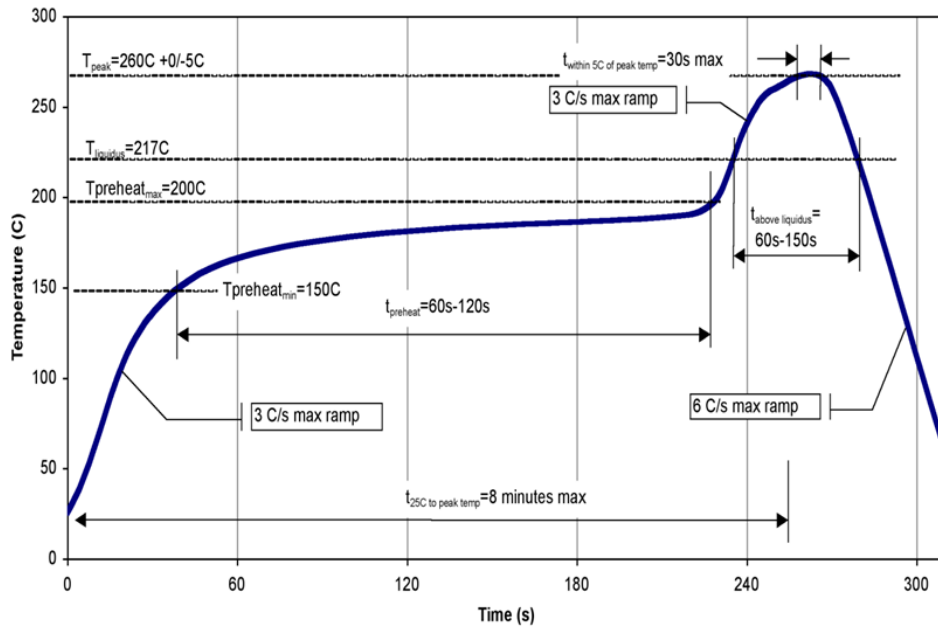

Tape and Reel Information

Standard T/R size = 2500 pieces on a 7" reel.

Material		Cavity (mm)				Distance Between Centerline (mm)		Carrier Tape (mm)	Cover Carrier (mm)
Vendor	Vendor P/N	Length (A0)	Width (B0)	Depth (K0)	Pitch (P1)	Length direction (P2)	Width Direction (F)	Width (W)	Width (W)
Tek-Pak	QFN0400X0450C	4.35	4.35	1.1	8.0	2.00	5.50	12.0	9.20

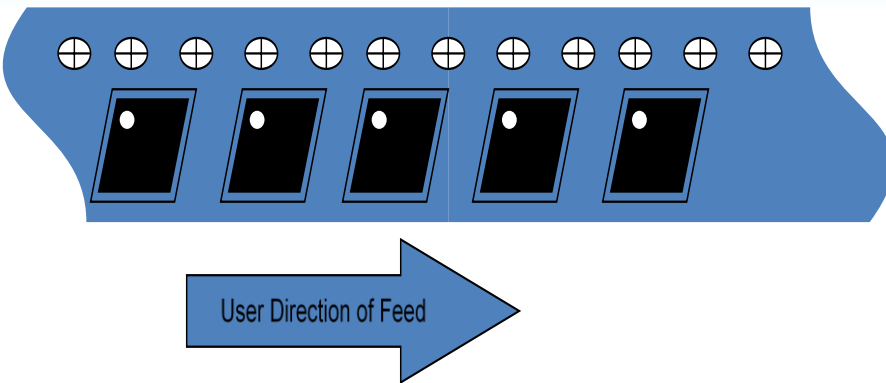
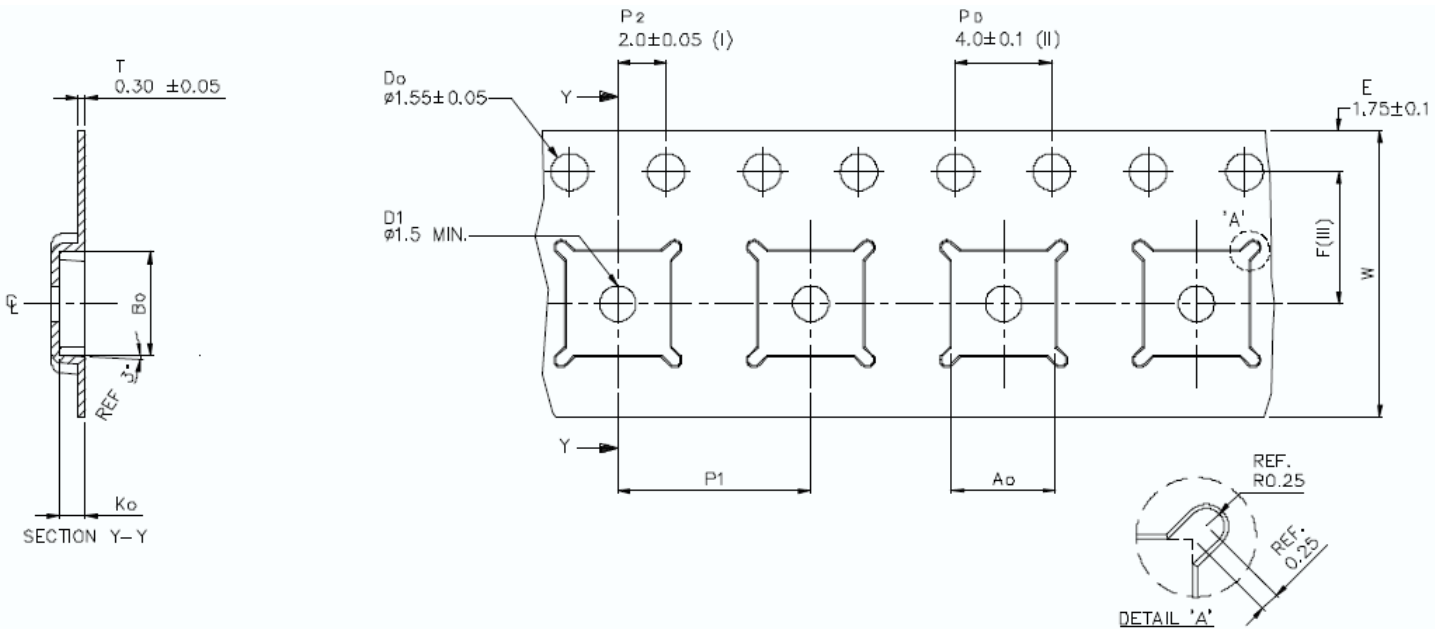

Handling Precautions

Parameter	Rating	Standard
ESD – Human Body Model (HBM)	1A	ANSI/ESD/JEDEC JS-001
ESD – Charge Device Model (CDM)	C2a	ANSI/ESD/JEDEC JS-002
MSL – Moisture Sensitivity Level	3	IPC/JEDEC J-STD-020



Caution!
ESD-Sensitive Device

RoHS Compliance

This product is compliant with the 2011/65/EU RoHS directive (Restrictions on the Use of Certain Hazardous Substances in Electrical and Electronic Equipment), as amended by Directive 2015/863/EU.

This product also has the following attributes:

- Lead Free
- Halogen Free (Chlorine, Bromine)
- Antimony Free
- TBBP-A (C₁₅H₁₂Br₄O₂) Free
- SVHC Free

Contact Information

For the latest specifications, additional product information, worldwide sales and distribution locations:

Tel: 1-844-890-8163

Web: www.qorvo.com

Email: customer.support@qorvo.com

Important Notice

The information contained herein is believed to be reliable; however, Qorvo makes no warranties regarding the information contained herein and assumes no responsibility or liability whatsoever for the use of the information contained herein. All information contained herein is subject to change without notice. Customers should obtain and verify the latest relevant information before placing orders for Qorvo products. The information contained herein or any use of such information does not grant, explicitly or implicitly, to any party any patent rights, licenses, or any other intellectual property rights, whether with regard to such information itself or anything described by such information. **THIS INFORMATION DOES NOT CONSTITUTE A WARRANTY WITH RESPECT TO THE PRODUCTS DESCRIBED HEREIN, AND QORVO HEREBY DISCLAIMS ANY AND ALL WARRANTIES WITH RESPECT TO SUCH PRODUCTS WHETHER EXPRESS OR IMPLIED BY LAW, COURSE OF DEALING, COURSE OF PERFORMANCE, USAGE OF TRADE OR OTHERWISE, INCLUDING THE IMPLIED WARRANTIES OF MERCHANTABILITY AND FITNESS FOR A PARTICULAR PURPOSE.**

Without limiting the generality of the foregoing, Qorvo products are not warranted or authorized for use as critical components in medical, life-saving, or life-sustaining applications, or other applications where a failure would reasonably be expected to cause severe personal injury or death.

Copyright 2020 © Qorvo, Inc. | Qorvo is a registered trademark of Qorvo, Inc.

Looking for pricing, stock, or lifecycle information?

Click below to explore more details on WIN SOURCE:

 [View QPA2628TR7 on WIN SOURCE](#)

 [Qorvo US Inc. Information](#)

Optimize Your Supply Chain with WIN SOURCE Solutions

-  Global Sourcing Solution
-  Obsolete Management
-  Cost Control Management
-  Shortage Management
-  Alternative Solution
-  Excess Inventory Management