



## MMIC SURFACE MOUNT

# Medium Power Amplifier **AVA-223MP+**

50Ω 100 kHz to 22 GHz Wideband Amplifier

### THE BIG DEAL

- Wide Bandwidth, 100 kHz to 22 GHz
- High Saturated Output Power, Typ. +27.2 dBm
- High OIP3, Typ. +38.2 dBm
- Low Noise Figure, Typ. 3 dB
- Positive Gain Slope from 4 to 22 GHz

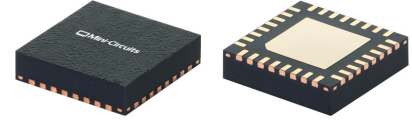

Generic photo used for illustration purposes only

### APPLICATIONS

- Test and Measurement Equipment
- 5G MIMO and Back Haul Radio
- Satellite Communication
- Radar, EW, and ECM Defense Systems

### FUNCTIONAL DIAGRAM (Top View)

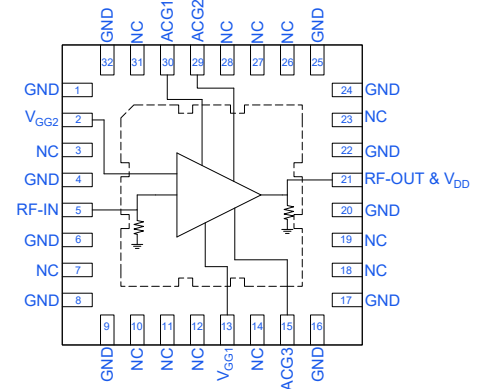

### PRODUCT OVERVIEW

Mini-Circuits' AVA-223MP+ is a wideband, high dynamic range, MMIC amplifier fabricated on a GaAs pHEMT process with high output power and broadband gain. Operating from 100 kHz to 22 GHz, this amplifier features typical +26 dBm P1dB, +27.2 dBm P<sub>SAT</sub>, 3 dB NF, and +38.2 dBm OIP3. The AVA-223MP+ comes in an industry standard 5x5 mm 32-Lead QFN-style package for ease of integration into dense circuit board layouts.

### KEY FEATURES

Features	Advantages
Wide Bandwidth: 100 kHz to 22 GHz	Supports a variety of broadband and narrowband applications without the need to reconfigure circuitry.
High Dynamic Range - Noise Figure: 3 dB - Output IP3: +38.2 dBm - Output P1dB: +26 dBm	Low noise figure, high IP3, and high P1dB make this ideal for use in high dynamic range receivers.
Positive Gain Slope from 4 to 22 GHz	Positive gain slope acts as equalization to counteract loss from other components in the signal chain as frequency increases.
5x5 mm 32-Lead QFN-Style Package	Small footprint saves space in dense layouts while providing low inductance, repeatable transitions, and excellent thermal contact to the PCB. Industry standard packaging allows for ease of assembly in high volume manufacturing processes.



**MMIC SURFACE MOUNT**

# Medium Power Amplifier **AVA-223MP+**

**50Ω 100 kHz to 22 GHz Wideband Amplifier****ELECTRICAL SPECIFICATIONS<sup>1</sup> AT +25°C, V<sub>DD</sub> = +10 V, V<sub>GG2</sub> = +3.5 V, AND Z<sub>0</sub> = 50Ω UNLESS NOTED OTHERWISE**

Parameter	Condition (GHz)	Min.	Typ.	Max.	Units
Frequency Range		0.0001		22	GHz
Gain	0.1 <sup>2</sup>		14.3		dB
	5	10.8	13.5		
	10	11.1	13.9		
	15	12.3	14.8		
	22	11.8	14.9		
Input Return Loss	0.1 <sup>2</sup>		20		dB
	5		18		
	10		18		
	15		20		
	22		12		
Output Return Loss	0.1 <sup>2</sup>		20		dB
	5		20		
	10		18		
	15		20		
	22		14		
Isolation	0.1-22		43.7		dB
Output Power at 1 dB Compression (P <sub>1dB</sub> )	0.1 <sup>2</sup>		+24.2		dBm
	5		+27.1		
	10		+26.0		
	15		+25.5		
	22		+23.6		
Output Power at Saturation (P <sub>SAT</sub> ) <sup>3</sup>	0.1 <sup>2</sup>		+27.2		dBm
	5		+29.3		
	10		+27.2		
	15		+27.8		
	22		+25.2		
Output Third-Order Intercept (OIP <sub>3</sub> ) (P <sub>OUT</sub> = +16 dBm/Tone)	0.1 <sup>2</sup>		+39.7		dBm
	5		+41.1		
	10		+38.2		
	15		+37.1		
	22		+29.7		
Noise Figure	0.1		5.2		dB
	5		3.1		
	10		3.0		
	15		3.3		
	22		4.4		
Device Operating Voltage (V <sub>DD</sub> )		+9	+10	+11	V
Gate Voltage (V <sub>GG1</sub> )		-2.0	-0.8	-0.6	V
Gate Voltage (V <sub>GG2</sub> ) <sup>4</sup>		+3.25	+3.5	+3.75	V
Device Operating Current (I <sub>DD</sub> ) <sup>5</sup>		250	300		mA
Gate Current (I <sub>GG1</sub> )			0.2		mA
Gate Current (I <sub>GG2</sub> )			1.4		mA
Device Current Variation vs. Temperature <sup>6</sup>			-157.7		μA/°C
Device Current Variation vs. Voltage <sup>7</sup>			+0.8		μA/mV

1. Tested on Mini-Circuits Characterization Test Board TB-AVA-223MPC+. See Figure 2. Board loss de-embedded to the device reference plane.

2. Tested on AVA-223MP+ Modified Application Circuit. See Figure 3. Board loss de-embedded to the device reference plane.

3. Defined as output power at which change is 0.1 dB per 1 dB change in input power.

4. V<sub>GG2</sub> should be set to +3.5 V for optimal performance. It is not recommended to operate V<sub>GG2</sub> outside of the specified range.

5. Current at P<sub>IN</sub> = -25 dBm. Increases to 380 mA at P<sub>SAT</sub>.

6. (Current at +85°C - Current at -45°C)/(+85°C - -45°C)

7. (Current at +11 V - Current at +9 V)/(+11 V - +9 V)





### TYPICAL PERFORMANCE GRAPHS

Note: Data over temperature was taken at  $V_{DD} = +10$  V. At  $+25^{\circ}\text{C}$ ,  $V_{GG1}$  has been adjusted to achieve  $I_{DD} = 300$  mA.  $V_{GG1}$  was not adjusted at  $-45^{\circ}\text{C}$  or  $+85^{\circ}\text{C}$ . For over voltage data,  $V_{GG1}$  was adjusted until  $I_{DD} = 300$  mA at all  $V_{DD}$  levels specified. All data taken with  $V_{GG2} = +3.5$  V.

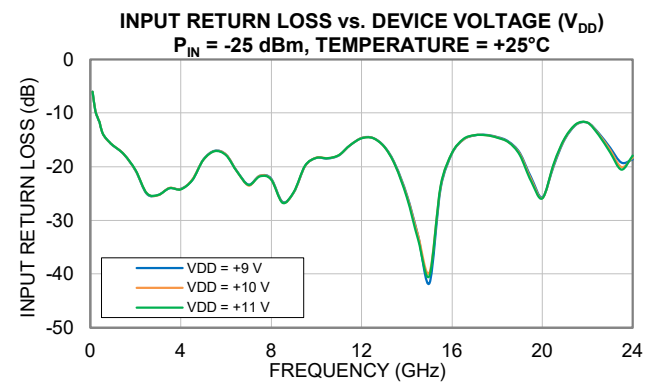
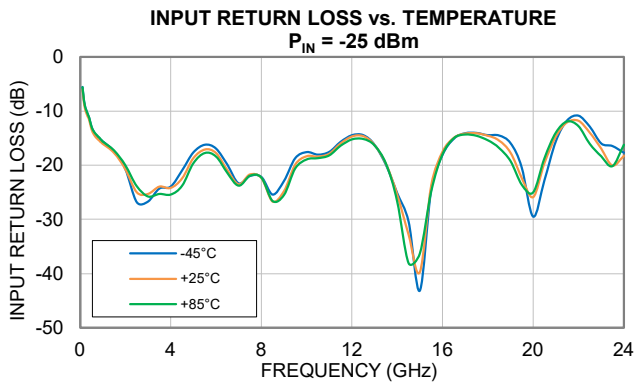
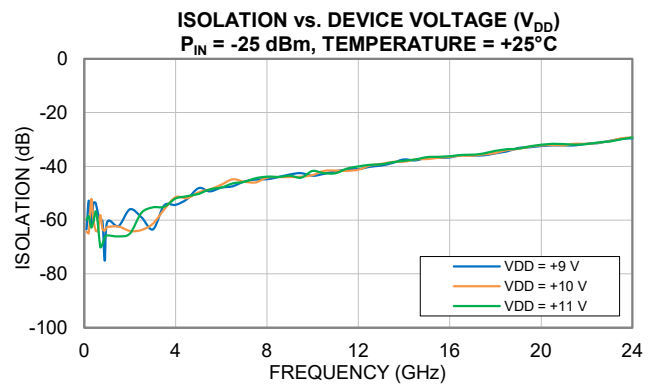
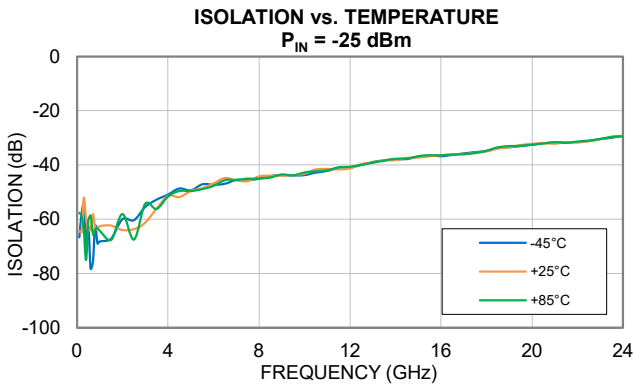
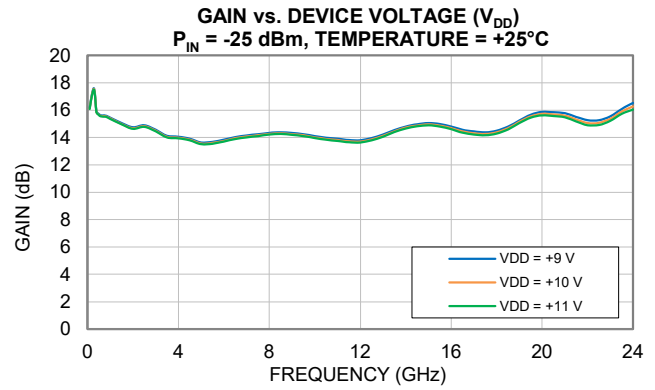
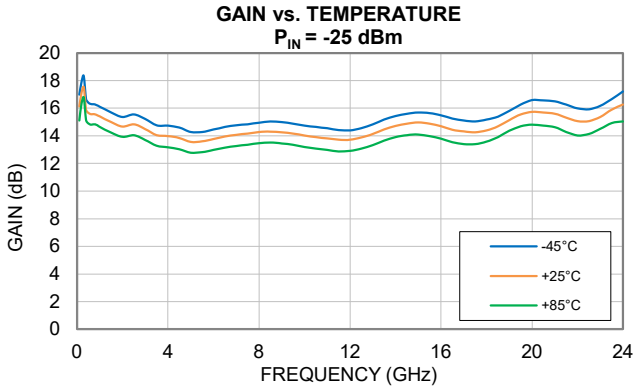



### TYPICAL PERFORMANCE GRAPHS

Note: Data over temperature was taken at  $V_{DD} = +10$  V. At  $+25^\circ\text{C}$ ,  $V_{GG1}$  has been adjusted to achieve  $I_{DD} = 300$  mA.  $V_{GG1}$  was not adjusted at  $-45^\circ\text{C}$  or  $+85^\circ\text{C}$ . For over voltage data,  $V_{GG1}$  was adjusted until  $I_{DD} = 300$  mA at all  $V_{DD}$  levels specified. All data taken with  $V_{GG2} = +3.5$  V.

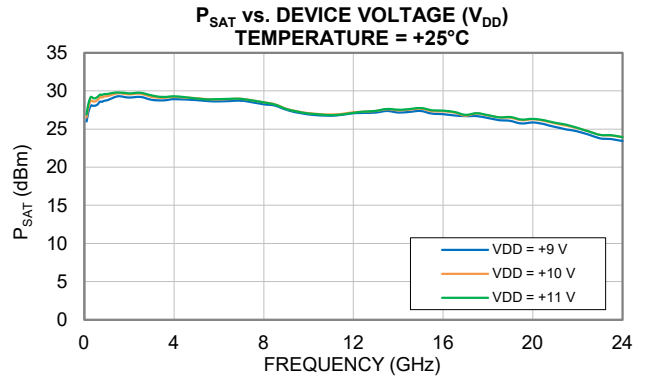
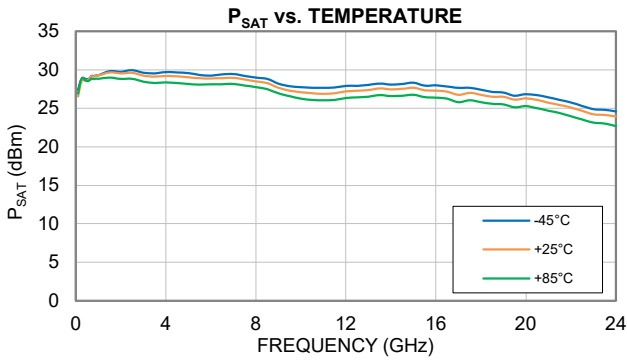
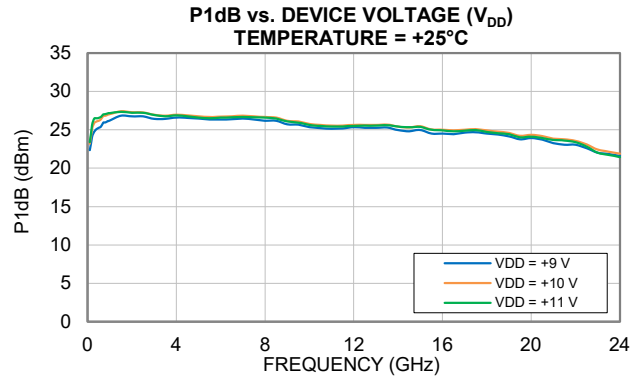
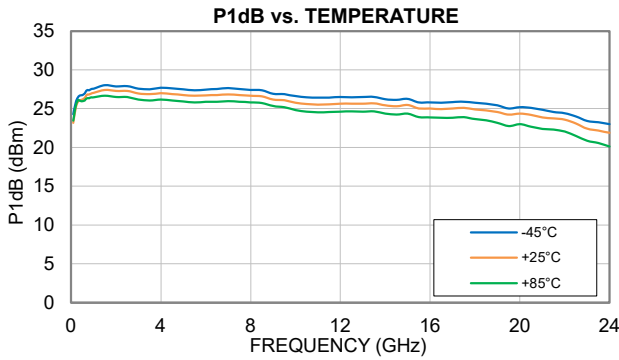
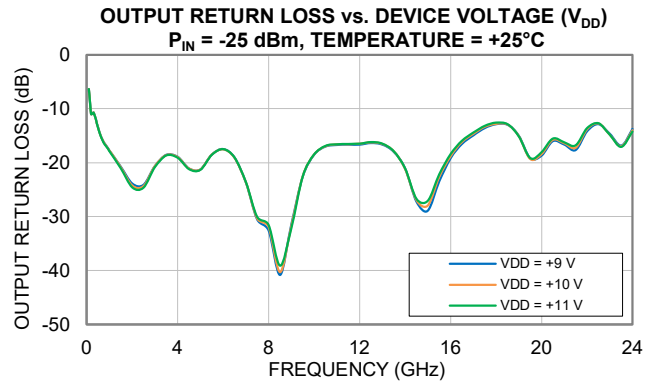
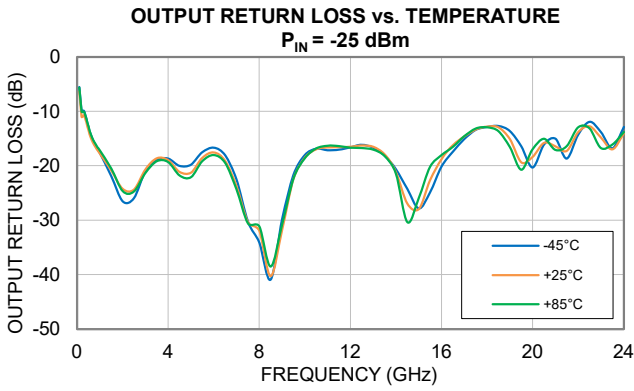



### TYPICAL PERFORMANCE GRAPHS

Note: Data over temperature was taken at  $V_{DD} = +10$  V. At  $+25^\circ\text{C}$ ,  $V_{GG1}$  has been adjusted to achieve  $I_{DD} = 300$  mA.  $V_{GG1}$  was not adjusted at  $-45^\circ\text{C}$  or  $+85^\circ\text{C}$ . For over voltage data,  $V_{GG1}$  was adjusted until  $I_{DD} = 300$  mA at all  $V_{DD}$  levels specified. All data taken with  $V_{GG2} = +3.5$  V.

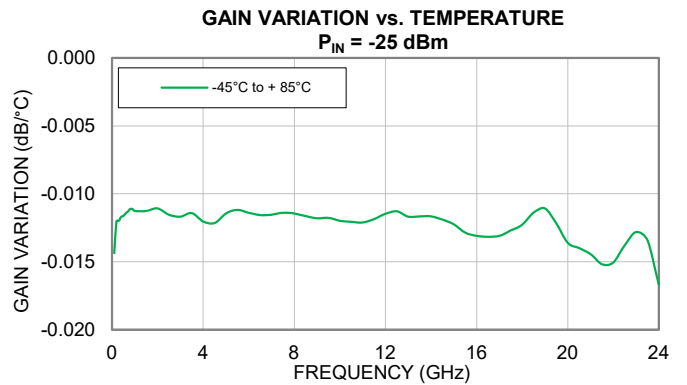
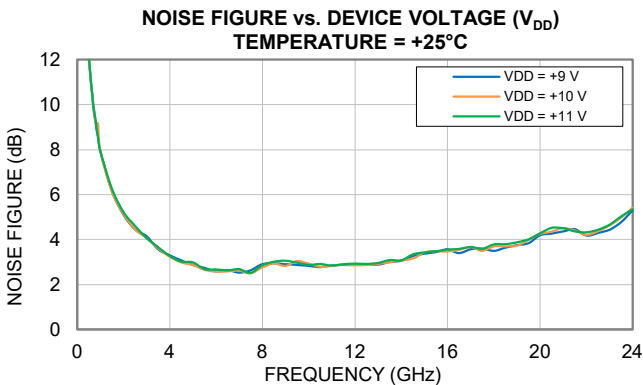
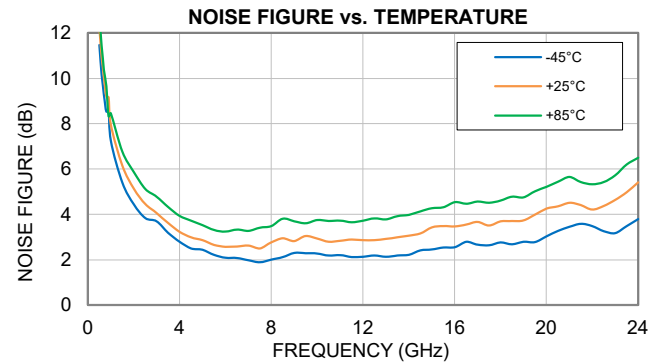
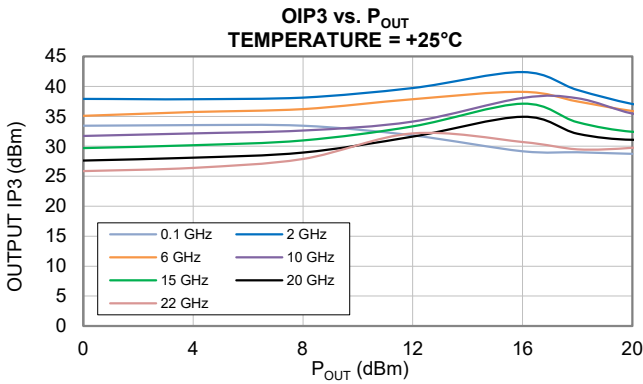
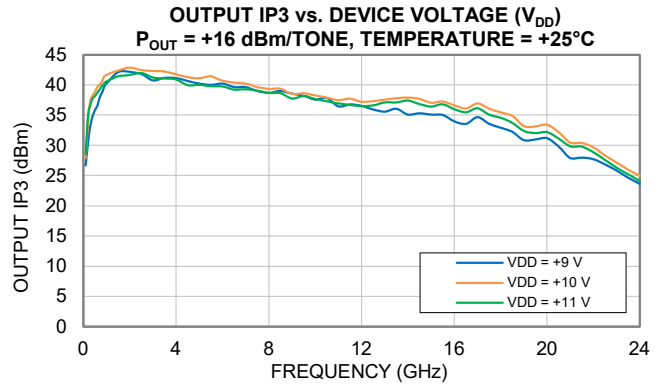
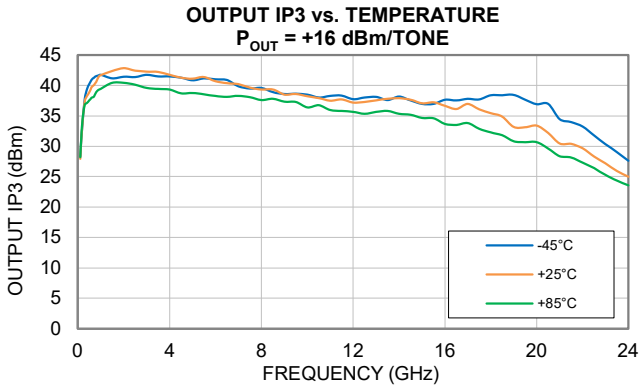



### TYPICAL PERFORMANCE GRAPHS

Note: Data over temperature was taken at  $V_{DD} = +10$  V. At  $+25^{\circ}\text{C}$ ,  $V_{GG1}$  has been adjusted to achieve  $I_{DD} = 300$  mA.  $V_{GG1}$  was not adjusted at  $-45^{\circ}\text{C}$  or  $+85^{\circ}\text{C}$ . For over voltage data,  $V_{GG1}$  was adjusted until  $I_{DD} = 300$  mA at all  $V_{DD}$  levels specified. All data taken with  $V_{GG2} = +3.5$  V.

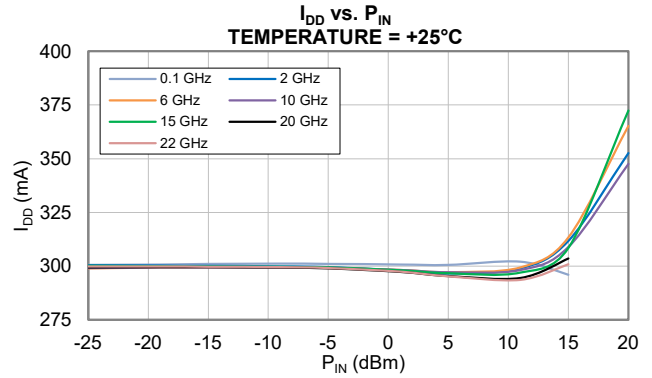
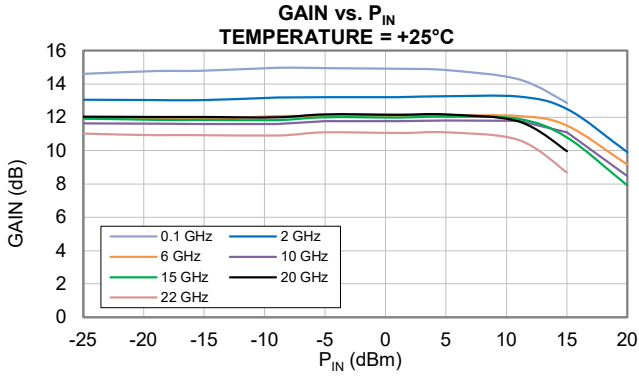



### TYPICAL PERFORMANCE GRAPHS

Note: Data was taken at  $V_{DD} = +10$  V and  $V_{GG2} = +3.5$  V. At  $+25^\circ\text{C}$ ,  $V_{GG1}$  has been adjusted to achieve  $I_{DD} = 300$  mA. Data was taken on a modified TB-AVA-223MPC+ test board using an external bias tee. See Figure 3.

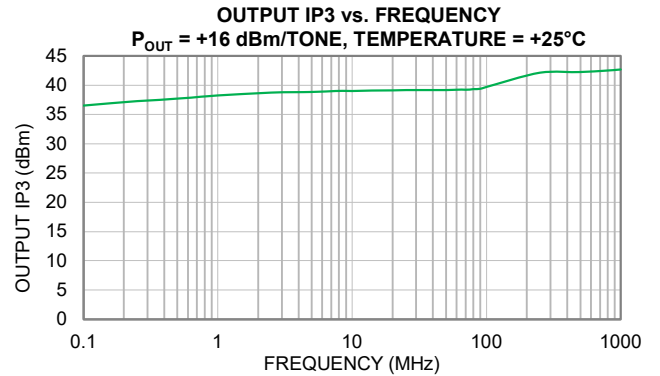
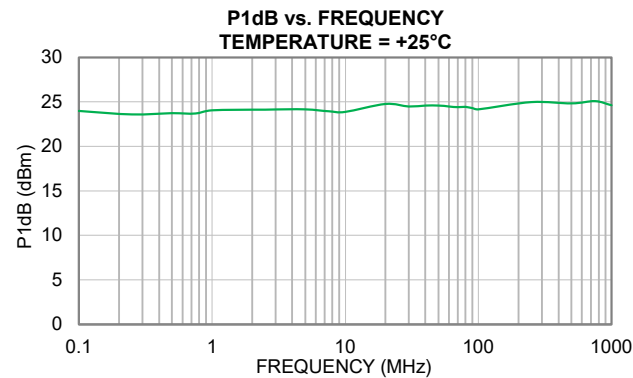
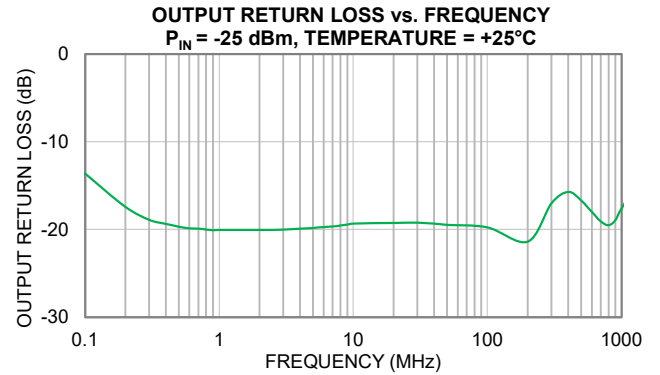
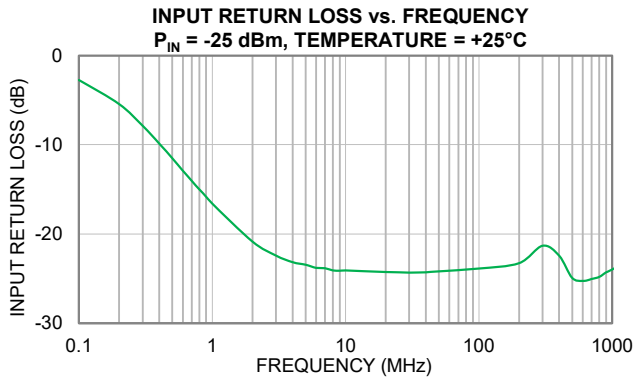
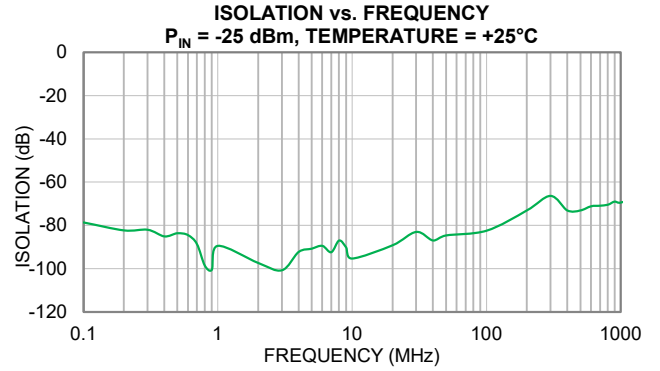
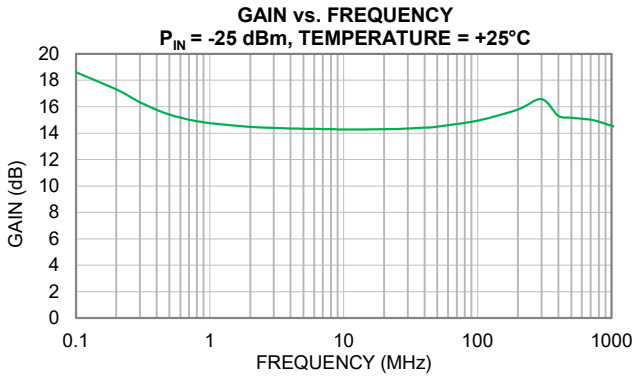



## MMIC SURFACE MOUNT

# Medium Power Amplifier **AVA-223MP+**

50Ω 100 kHz to 22 GHz Wideband Amplifier

### ABSOLUTE MAXIMUM RATINGS<sup>8</sup>

Parameter	Ratings
Operating Temperature	-45°C to +85°C
Storage Temperature	-65°C to +150°C
Total Power Dissipation	6.38 W
Junction Temperature <sup>9</sup>	+175°C
Input Power (CW), $V_{DD} = +10$ V	+22 dBm
DC Voltage on RF-OUT & $V_{DD}$	+14 V
DC Voltage on RF-IN	+6 V
DC Gate Voltage on $V_{GG1}$	-3 V < $V_{GG1}$ < 0 V
DC Gate Voltage on $V_{GG2}$	+5 V
DC Drain Current $I_{DD}$	500 mA
DC Gate Current $I_{GG1}$	1 mA
DC Gate Current $I_{GG2}$	10 mA

8. Permanent damage may occur if any of these limits are exceeded. Maximum ratings are not intended for continuous normal operation.

9. Peak Temperature on top of Die.

### THERMAL RESISTANCE

Parameter	Ratings
Thermal Resistance ( $\Theta_{JC}$ ) <sup>10</sup>	14.1°C/W

10.  $\Theta_{JC}$  = (Hot Spot Temperature on Die - Temperature at Ground Lead)/Dissipated Power

### ESD RATING

	Class	Voltage Range	Reference Standard
HBM	1B	500 V < 1000 V	ANSI/ESDA/JEDEC JS-001-2023
CDM	C3	> 1000 V	ANSI/ESDA/JEDEC JS-002-2022



ESD HANDLING PRECAUTION: This device is designed to be Class 1B for HBM. Static charges may easily produce potentials higher than this with improper handling and can discharge into DUT and damage it. As a preventive measure Industry standard ESD handling precautions should be used at all times to protect the device from ESD damage.

### MSL RATING

Moisture Sensitivity: MSL3 in accordance with IPC/JEDEC J-STD-020E/JEDEC J-STD-033C





MMIC SURFACE MOUNT

# Medium Power Amplifier **AVA-223MP+**

50Ω 100 kHz to 22 GHz Wideband Amplifier

## FUNCTIONAL DIAGRAM (Top View)

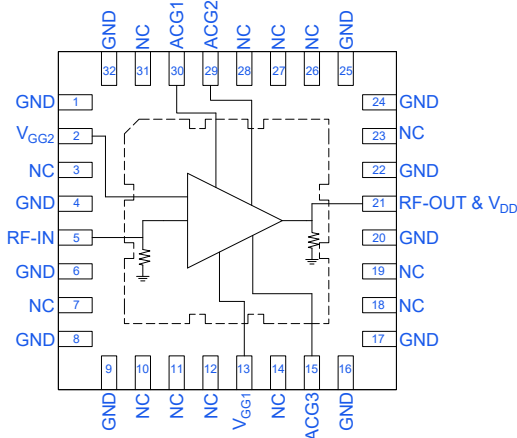

Figure 1. AVA-223MP+ Functional Diagram

## PAD DESCRIPTION

Function	Pad Number	Description (Refer to Fig 2)
RF-IN	5	RF-IN pad connects to RF Input port.
RF-OUT & V <sub>DD</sub>	21	RF-OUT & V <sub>DD</sub> pad connects to RF-Output port and voltage input port, V <sub>DD</sub> .
V <sub>GG1</sub>	13	DC Input pad connects to voltage input port, V <sub>GG1</sub> .
V <sub>GG2</sub>	2	DC Input pad connects to voltage input port, V <sub>GG2</sub> .
ACG1	30	ACG1 pad connects to AC ground port 1.
ACG2	29	ACG2 pad connects to AC ground port 2.
ACG3	15	ACG3 pad connects to AC ground port 3.
GND	1, 4, 6, 8, 9, 16, 17, 20, 22, 24, 25, 32, & Paddle	Connects to ground.
NC	3, 7, 10-12, 14, 18, 19, 23, 26-28, 31	Not used internally. Connected to ground on test board.

## EVALUATION BOARD

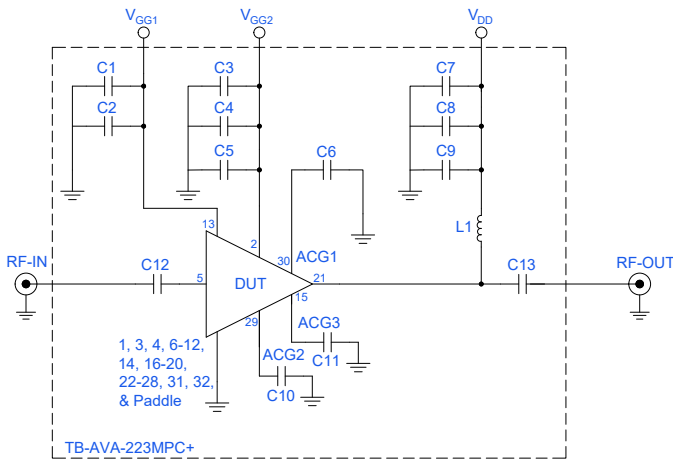

Figure 2. AVA-223MP+ Evaluation and Application Circuit

### Electrical Parameters and Conditions

Gain, Return Loss, Output Power at 1 dB Compression (P<sub>1dB</sub>), Output Power at Saturation (P<sub>SAT</sub>), Output IP3 (OIP3), and Noise Figure measured using PNA-X N5245B Microwave Network Analyzer.

Conditions:

- Gain and Return Loss: P<sub>IN</sub> = -25 dBm
- Output IP3 (OIP3): Two tones, spaced 1 MHz apart, +16 dBm/Tone at output.

### Power ON/Power OFF Sequence<sup>11</sup>

Caution: Permanent damage to the device will occur if the Power ON and Power OFF sequences are not followed.

#### POWER ON:

- Set V<sub>GG1</sub> = -2 V. Apply V<sub>GG1</sub>.
- Set V<sub>GG2</sub> = +3.5 V. Apply V<sub>GG2</sub>.
- Set V<sub>DD</sub> = +10 V. Apply V<sub>DD</sub>.
- Increase V<sub>GG1</sub> to obtain the desired I<sub>DD</sub> as shown in specification table.
- Apply RF Signal.

#### POWER OFF:

- Turn off RF Signal.
- Adjust V<sub>GG1</sub> to -2 V.
- Turn off V<sub>DD</sub>.
- Turn off V<sub>GG2</sub>.
- Turn off V<sub>GG1</sub>.

11. V<sub>GG2</sub> may be derived from V<sub>DD</sub> using a resistive divider, zener diode, or equivalent circuit. If V<sub>GG2</sub> is derived from V<sub>DD</sub>, it may be applied simultaneously with V<sub>DD</sub>.

Component	Value	Size	Part Number	Manufacturer
C5, C9	100 pF	0603	GRM1885C1H101GA01D	Murata
C2, C4, C6, C8, C11	0.01 μF	0402	GRM155R71E103KA01D	Murata
C12, C13	30 pF	0201	P21BN300M5S	DLI
C1, C3, C7, C10	4.7 μF	1812	C4532X7S2A475K230KB	TDK Corp
L1	0.22 μH	0.2 x 0.15 in	CCM19T40-002	Piconics





MMIC SURFACE MOUNT

# Medium Power Amplifier **AVA-223MP+**

50Ω 100 kHz to 22 GHz Wideband Amplifier

## EVALUATION AND APPLICATION CIRCUIT

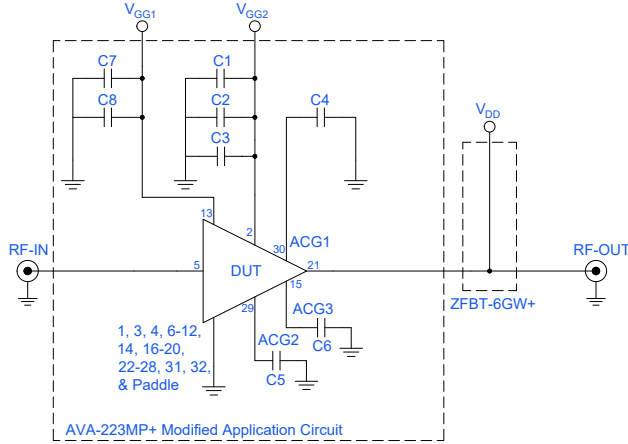

### Electrical Parameters and Conditions

Gain and Return Loss measured using P5022A Vector Network Analyzer.  
 Output Power at 1 dB Compression (P1dB) measured using Mini-Circuits' PWR-4GHS Power Sensor.

Output IP3 (OIP3) measured using MXA N9020A Signal Analyzer.

1. Gain and Return Loss:  $P_{IN} = -25$  dBm
2. Output IP3 (OIP3): Two tones, spaced 1 MHz apart, +16 dBm/tone at output.

Figure 3. AVA-223MP+ Low Frequency Evaluation and Application Circuit

Component	Value	Size	Part Number	Manufacturer
C2, C4, C6, C8	0.01 $\mu$ F	0402	GRM155R71E103KA01D	Murata
C1, C5, C7	4.7 $\mu$ F	1812	C4532X7S2A475K230KB	TDK Corp
C3	100 pF	0603	GRM1885C1H101GA01D	Murata





MMIC SURFACE MOUNT

# Medium Power Amplifier **AVA-223MP+**

50Ω 100 kHz to 22 GHz Wideband Amplifier

ADDITIONAL DETAILED INFORMATION IS AVAILABLE ON OUR DASHBOARD

[CLICK HERE](#)

Performance Data & Graphs	Data
	Graphs
	S-Parameter (S2P Files) Data Set (.zip file)
Case Style	DG1677-8 Plastic package, exposed paddle, Lead Finish: Nickle Palladium Gold
RoHS Status	Compliant
Tape & Reel Standard quantities available on reel	F102 7" reels with 20, 50, 100, 200, 500 devices 13" reels with 1000 devices
Suggested Layout for PCB Design	PL-804
Evaluation Board	TB-AVA-223MPC+
	Gerber File
Environmental Ratings	ENV08T10
Product Handling	The use of no-clean solder is recommended. This package cannot be subjected to aqueous wash.

**NOTES**

- A. Performance and quality attributes and conditions not expressly stated in this specification document are intended to be excluded and do not form a part of this specification document.
- B. Electrical specifications and performance data contained in this specification document are based on Mini-Circuit's applicable established test performance criteria and measurement instructions.
- C. The parts covered by this specification document are subject to Mini-Circuits standard limited warranty and terms and conditions (collectively, "Standard Terms"); Purchasers of this part are entitled to the rights and benefits contained therein. For a full statement of the standard terms and the exclusive rights and remedies thereunder, please visit Mini-Circuits' website at [www.minicircuits.com/terms/viewterm.html](http://www.minicircuits.com/terms/viewterm.html)



## Looking for pricing, stock, or lifecycle information?

Click below to explore more details on WIN SOURCE:

 [View AVA-223MP+ on WIN SOURCE](#)

 [Mini-Circuits Information](#)

## Optimize Your Supply Chain with WIN SOURCE Solutions

-  Global Sourcing Solution
-  Obsolete Management
-  Cost Control Management
-  Shortage Management
-  Alternative Solution
-  Excess Inventory Management