



## NT1192FAAE1S

### 1.2 GHz band GNSS Low Noise Amplifier

#### FEATURES

- Frequency range: 1164 MHz to 1300 MHz
- Supply voltage: 1.5 V to 3.7 V (2.8 V typ.)
- Low current: 4.5 mA typ.
- High gain: 20.0 dB typ. @f = 1176 MHz  
20.0 dB typ. @f = 1227 MHz  
19.5 dB typ. @f = 1278 MHz
- Low NF: 0.7 dB typ. @f = 1176 MHz  
0.7 dB typ. @f = 1227 MHz  
0.7 dB typ. @f = 1278 MHz
- P-1dB(IN): -13.5 dBm typ. @f = 1176 MHz  
-13.0 dBm typ. @f = 1227 MHz  
-13.0 dBm typ. @f = 1278 MHz
- Small package size: 0.7 x 1.1 x 0.37 mm typ.
- RoHS compliant and Halogen Free, MSL1

#### GENERAL DESCRIPTION

The NT1192 is a low noise amplifier (LNA) GaAs MMIC designed for GNSS 1.2GHz band applications.

The NT1192 is featured high gain and low noise figure from 1164 MHz to 1300 MHz, which makes it ideal for L5/L2/L6 band GNSS applications and operates from 1.5 V to 3.7 V single voltage. Also, this LNA has the function of stand-by mode.

This LNA achieves compact mounting area by small size package EPFFP6-FA and only two external components.

#### APPLICATIONS

- GNSS L5/L2/L6 band application
- GNSS module, timing module
- Automotive antenna, navigation, dashboard camera
- Tracking device

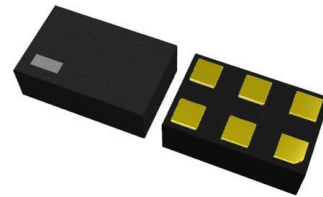

EPFFP6-FA  
0.7 x 1.1 x 0.37 (mm)

#### BLOCK DIAGRAM

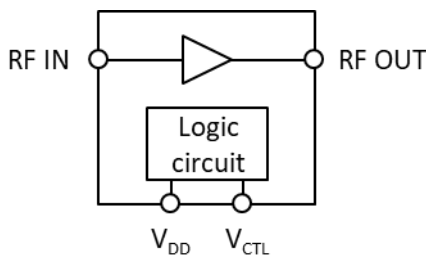

## ■ PRODUCT NAME INFORMATION

**NT1192 FA A E1 S**

Description of configuration

Suffix	Parameter	Description
FA	Package code	Indicates the package. Refer to the order information.
A	Version	Indicates the product version. "A" is initial version.
E1	Packing	Refer to the packing specifications.
S	Grade	Indicates the quality grade. "S" means general-purpose and consumer application. Operating temperature range: -40°C to 105°C, Test temperature: 25°C

## ■ ORDER INFORMATION

PRODUCT NAME	PACKAGE	RoHS	HALOGEN-FREE	PLATING COMPOSITION	MARKING	WEIGHT (mg)	Quantity per Reel (pcs)
NT1192FAAE1S	EPFFP6-FA	Yes	Yes	Au	7	0.7	3000

■ PIN DESCRIPTIONS

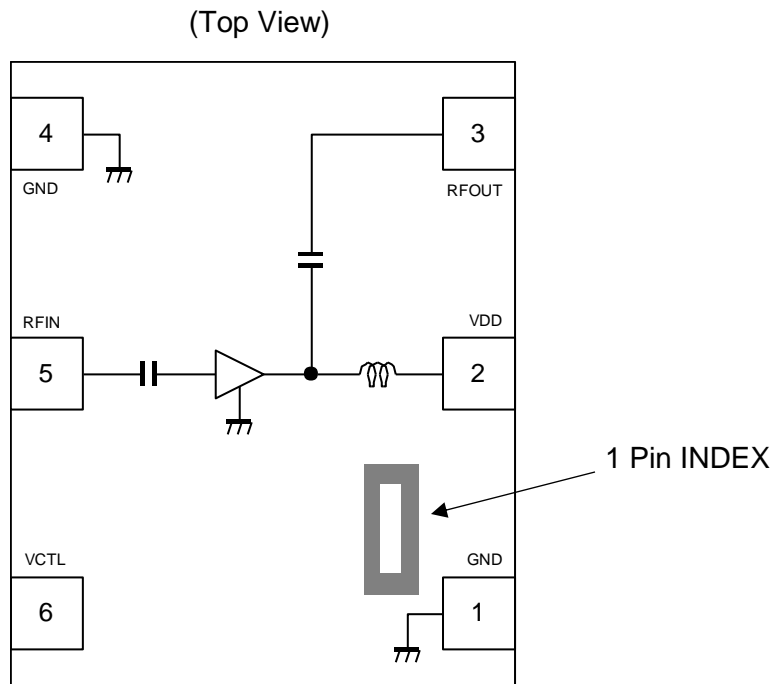

EPFFP6-FA Pin Configuration

Pin No.	Pin Name	Description
1	GND	Ground terminal
2	VDD	Operating voltage supply terminal
3	RFOUT	RF output terminal
4	GND	Ground terminal
5	RFIN	RF input terminal
6	VCTL	Control signal input terminal

Please refer to "APPLICATION CIRCUIT" for details.

■ TRUTH TABLE

"H"= $V_{CTL}(H)$ , "L"= $V_{CTL}(L)$

$V_{CTL}$	Mode
H	Active mode
L	Stand-by mode

■ ABSOLUTE MAXIMUM RATINGS

General conditions:  $T_a = +25^{\circ}\text{C}$ ,  $Z_s = Z_l = 50\Omega$

Parameter	Symbol	Ratings	Unit
Supply voltage	$V_{DD}$	5.0	V
Control voltage	$V_{CTL}$	5.0	V
Input power	$P_{IN}^{*1}$	+15	dBm
Power dissipation	$P_D^{*2}$	430	mW
Operating temperature range	$T_{opr}$	-40 to +105	$^{\circ}\text{C}$
Storage temperature range	$T_{stg}$	-55 to +150	$^{\circ}\text{C}$

\*1  $V_{DD} = 2.8\text{ V}$

\*2 4-layer FR4 PCB with through-hole (101.5 x 114.5 mm),  $T_j = 150^{\circ}\text{C}$

ABSOLUTE MAXIMUM RATINGS

Electronic and mechanical stress momentarily exceeded absolute maximum ratings may cause permanent damage and may degrade the lifetime and safety for both device and system using the device in the field. The functional operation at or over these absolute maximum ratings is not assured.

■ ELECTROSTATIC DISCHARGE (ESD) PROTECTION VOLTAGE

Symbol	Conditions	Protection Voltage
HBM	$C = 100\text{ pF}$ , $R = 1.5\text{ k}\Omega$	$\pm 2000\text{ V}$
CDM	Direct CDM	$\pm 1000\text{ V}$

ESD PROTECTION VOLTAGE

The electrostatic discharge test is done based on JEITA ED-4701.  
In the HBM method, ESD is applied using the GND pin as reference pins.

■ RECOMMENDED OPERATING CONDITIONS

Parameter	Symbol	Value	Unit
Supply voltage	V <sub>DD</sub>	1.5 to 3.7	V
Control voltage	V <sub>CTL</sub>	1.5 to 3.7	V
Operating temperature range	T <sub>a</sub>	-40 to +105	°C

RECOMMENDED OPERATING CONDITIONS

All of electronic equipment should be designed that the mounted semiconductor devices operate within the recommended operating conditions. The semiconductor devices cannot operate normally over the recommended operating conditions, even if when they are used over such conditions by momentary electronic noise or surge. And the semiconductor devices may receive serious damage when they continue to operate over the recommended operating conditions.

■ ELECTRICAL CHARACTERISTICS 1 (DC)

General conditions: T<sub>a</sub> = +25°C, Z<sub>s</sub> = Z<sub>l</sub> = 50Ω

Parameter	Symbol	Conditions	MIN	TYP	MAX	Unit
Supply voltage	V <sub>DD</sub>		1.5	2.8	3.7	V
Control voltage (High)	V <sub>CTL(H)</sub>		1.5	1.8	3.7	V
Control voltage (Low)	V <sub>CTL(L)</sub>		0	0	0.3	V
Operating current	I <sub>DD</sub>	RF OFF, V <sub>DD</sub> = 2.8 V, V <sub>CTL</sub> = 1.8 V	-	4.5	8.0	mA
		RF OFF, V <sub>DD</sub> = 1.8 V, V <sub>CTL</sub> = 1.8 V	-	3.5	7.0	
		RF OFF, V <sub>DD</sub> = 2.8 V, V <sub>CTL</sub> = 0 V	-	0.1	3.0	μA
		RF OFF, V <sub>DD</sub> = 1.8 V, V <sub>CTL</sub> = 0 V	-	0.1	3.0	
Control current	I <sub>CTL</sub>	RF OFF, V <sub>CTL</sub> = 1.8 V	-	5	12	μA

■ ELECTRICAL CHARACTERISTICS 2 (RF)

General conditions:  $V_{DD} = 2.8\text{ V}$ ,  $V_{CTL} = 1.8\text{ V}$ ,  $f = 1164\text{ MHz to }1300\text{ MHz}$ ,  $T_a = +25^\circ\text{C}$ ,  $Z_s = Z_l = 50\Omega$ , with application circuit

Parameter	Symbol	Conditions	MIN	TYP	MAX	Unit
Small signal gain	Gain	f = 1176 MHz (L5 band), Exclude PCB, connector loss (0.09 dB)	16.0	20.0	24.0	dB
		f = 1227 MHz (L2 band), Exclude PCB, connector loss (0.10 dB)				
		f = 1278 MHz (L6 band), Exclude PCB, connector loss (0.11 dB)	16.0	19.5	24.0	
Noise figure	NF	f = 1176 MHz (L5 band), Exclude PCB, connector loss (0.09 dB)	-	0.70	1.0	dB
		f = 1227 MHz (L2 band), Exclude PCB, connector loss (0.10 dB)				
		f = 1278 MHz (L6 band), Exclude PCB, connector loss (0.11 dB)				
Isolation	ISL	f = 1176 MHz (L5 band)	25	35	-	dB
		f = 1227 MHz (L2 band)				
		f = 1278 MHz (L6 band)				
Input power at 1 dB gain compression point	P-1dB(IN)	f = 1176 MHz (L5 band)	-18.0	-13.5	-	dBm
		f = 1227 MHz (L2 band)	-18.0	-13.0	-	
		f = 1278 MHz (L6 band)				
Input 3rd order intercept point	IIP3	f1 = 1176 MHz, f2 = f1 + 1 MHz, $P_{IN} = -30\text{ dBm}$	-6.5	-2.0	-	dBm
		f1 = 1227 MHz, f2 = f1 + 1 MHz, $P_{IN} = -30\text{ dBm}$				
		f1 = 1278 MHz, f2 = f1 + 1 MHz, $P_{IN} = -30\text{ dBm}$				
RFIN Return loss	RLi	f = 1176 MHz (L5 band)	6.0	12.0	-	dB
		f = 1227 MHz (L2 band)	6.0	15.0	-	
		f = 1278 MHz (L6 band)				
RFOUT Return loss	RLo	f = 1176 MHz (L5 band)	6.0	11.0	-	dB
		f = 1227 MHz (L2 band)	6.0	10.0	-	
		f = 1278 MHz (L6 band)				
k factor	k	f = 50 MHz to 10 GHz	1.0	-	-	-

■ ELECTRICAL CHARACTERISTICS 3 (RF)

General conditions:  $V_{DD} = 1.8\text{ V}$ ,  $V_{CTL} = 1.8\text{ V}$ ,  $f = 1164\text{ MHz to }1300\text{ MHz}$ ,  $T_a = +25^\circ\text{C}$ ,  $Z_s = Z_l = 50\Omega$ , with application circuit

Parameter	Symbol	Conditions	MIN	TYP	MAX	Unit
Small signal gain	Gain	f = 1176 MHz (L5 band), Exclude PCB, connector loss (0.09 dB)	15.0	19.5	23.0	dB
		f = 1227 MHz (L2 band), Exclude PCB, connector loss (0.10 dB)				
		f = 1278 MHz (L6 band), Exclude PCB, connector loss (0.11 dB)	15.0	19.0	23.0	
Noise figure	NF	f = 1176 MHz (L5 band), Exclude PCB, connector loss (0.09 dB)	-	0.75	1.0	dB
		f = 1227 MHz (L2 band), Exclude PCB, connector loss (0.10 dB)				
		f = 1278 MHz (L6 band), Exclude PCB, connector loss (0.11 dB)				
Isolation	ISL	f = 1176 MHz (L5 band)	25	35	-	dB
		f = 1227 MHz (L2 band)				
		f = 1278 MHz (L6 band)				
Input power at 1 dB gain compression point	P-1dB(IN)	f = 1176 MHz (L5 band)	-21.0	-17.0	-	dBm
		f = 1227 MHz (L2 band)				
		f = 1278 MHz (L6 band)	-21.0	-16.0	-	
Input 3rd order intercept point	IIP3	f1 = 1176 MHz, f2 = f1 + 1 MHz, $P_{IN} = -30\text{ dBm}$	-9.5	-5.5	-	dBm
		f1 = 1227 MHz, f2 = f1 + 1 MHz, $P_{IN} = -30\text{ dBm}$				
		f1 = 1278 MHz, f2 = f1 + 1 MHz, $P_{IN} = -30\text{ dBm}$	-9.5	-5.0	-	
RFIN Return loss	RLi	f = 1176 MHz (L5 band)	6.0	11.0	-	dB
		f = 1227 MHz (L2 band)	6.0	15.0	-	
		f = 1278 MHz (L6 band)	6.0	14.0	-	
RFOUT Return loss	RLo	f = 1176 MHz (L5 band)	6.0	11.0	-	dB
		f = 1227 MHz (L2 band)				
		f = 1278 MHz (L6 band)	5.0	9.0	-	
k factor	k	f = 50 MHz to 10 GHz	1.0	-	-	-

■ TYPICAL CHARACTERISTICS

Conditions:  $V_{DD} = 2.8\text{ V}$ ,  $V_{CTL} = 1.8\text{ V}$ ,  $T_a = 25^\circ\text{C}$ ,  $Z_s = Z_l = 50\ \Omega$ , with application circuit.  
 (Typical Characteristics are intended to be used as reference data; they are not guaranteed.)

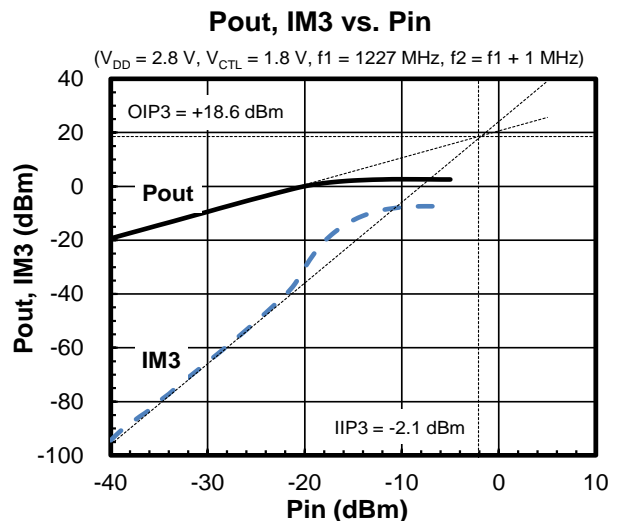
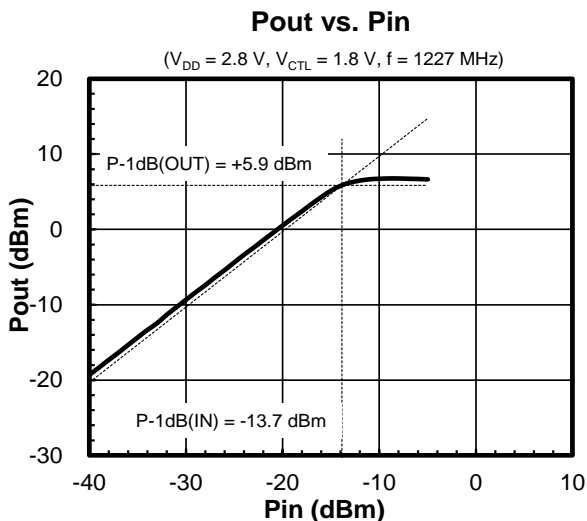
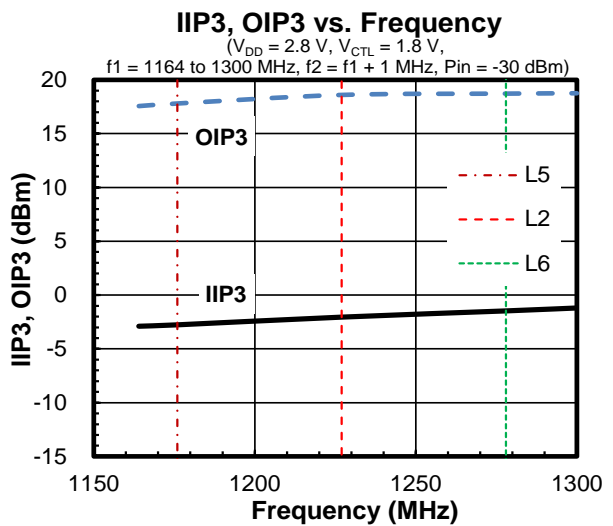
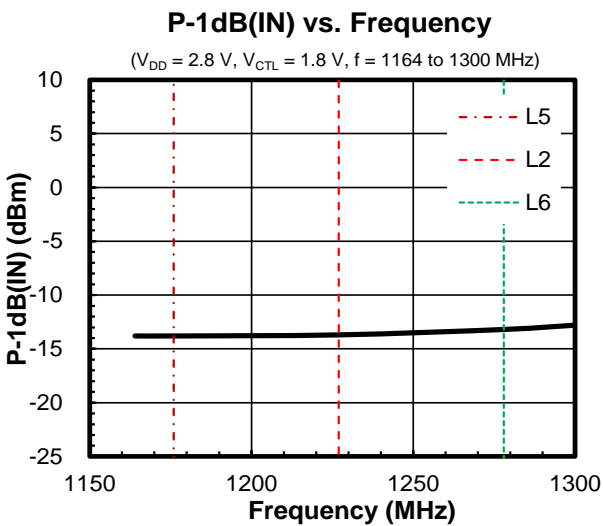
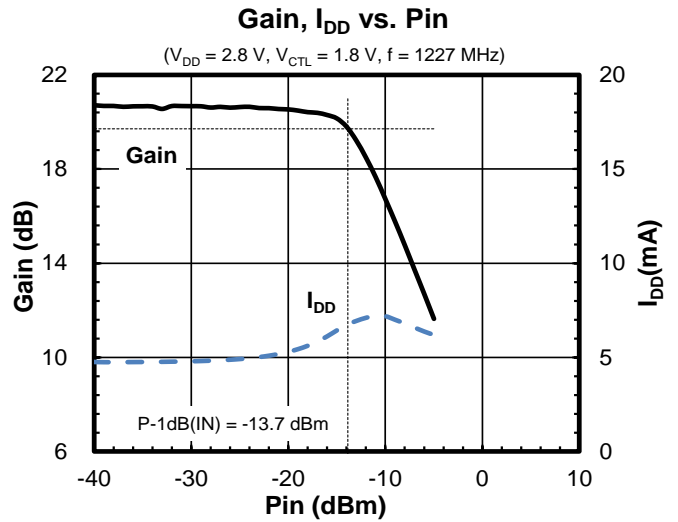
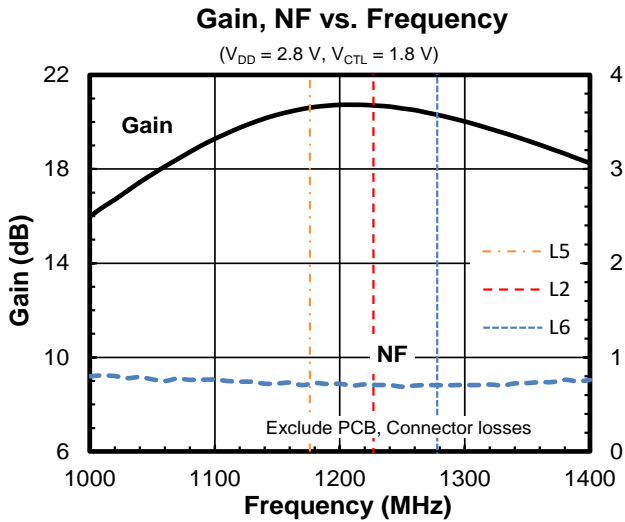

■ TYPICAL CHARACTERISTICS

Conditions:  $V_{DD} = 2.8\text{ V}$ ,  $V_{CTL} = 1.8\text{ V}$ ,  $T_a = 25^\circ\text{C}$ ,  $Z_s = Z_l = 50\ \Omega$ , with application circuit.  
 (Typical Characteristics are intended to be used as reference data; they are not guaranteed.)

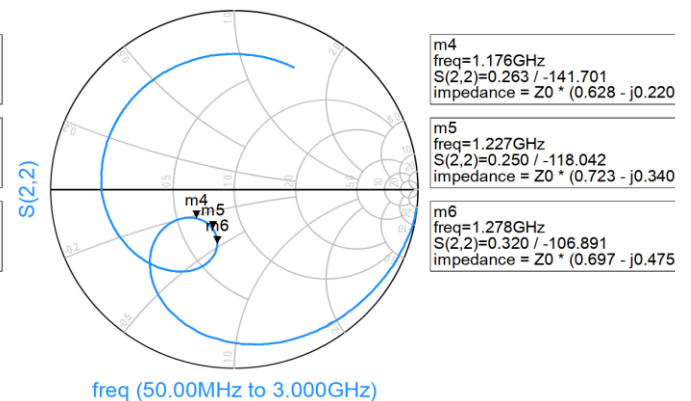
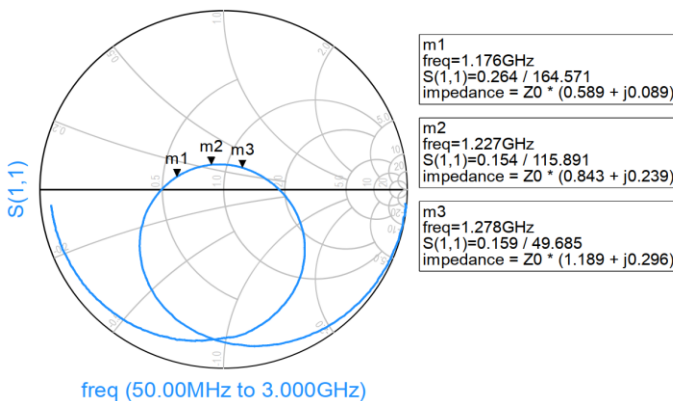
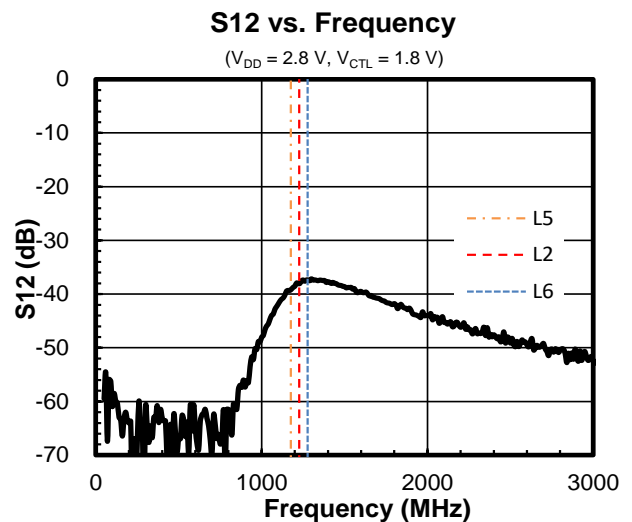
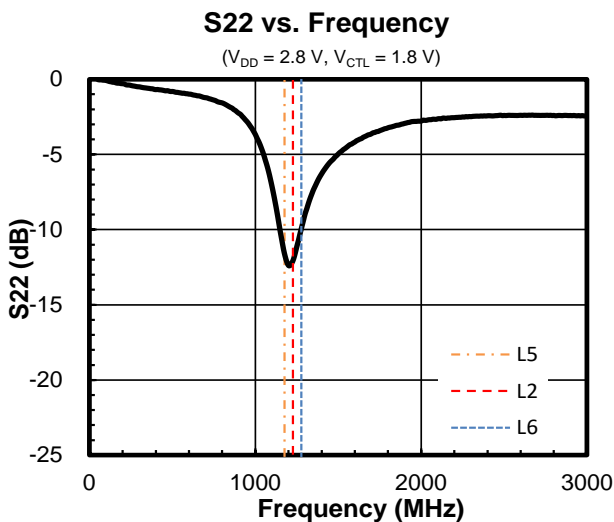
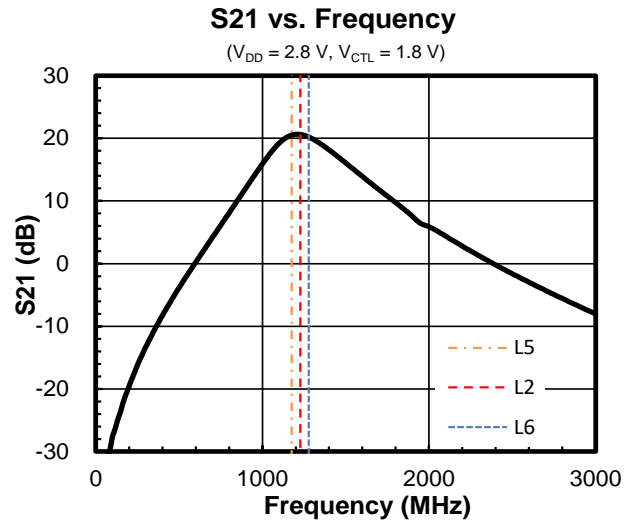
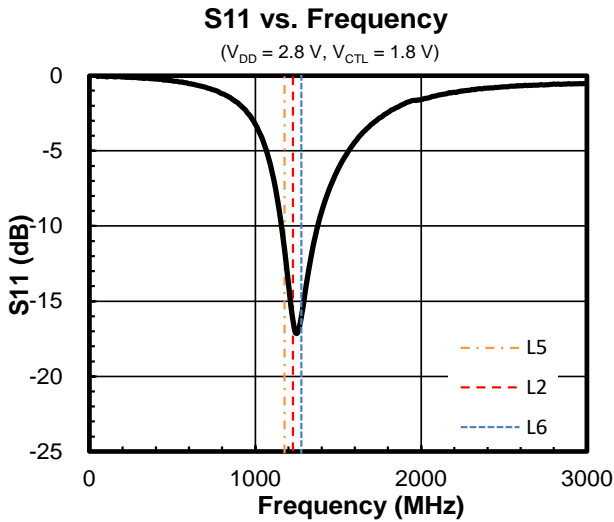

■ TYPICAL CHARACTERISTICS

Conditions:  $V_{DD} = 2.8\text{ V}$ ,  $V_{CTL} = 1.8\text{ V}$ ,  $T_a = 25^\circ\text{C}$ ,  $Z_s = Z_l = 50\ \Omega$ , with application circuit.

(Typical Characteristics are intended to be used as reference data; they are not guaranteed.)

S11 vs. Frequency

( $V_{DD} = 2.8\text{ V}$ ,  $V_{CTL} = 1.8\text{ V}$ )

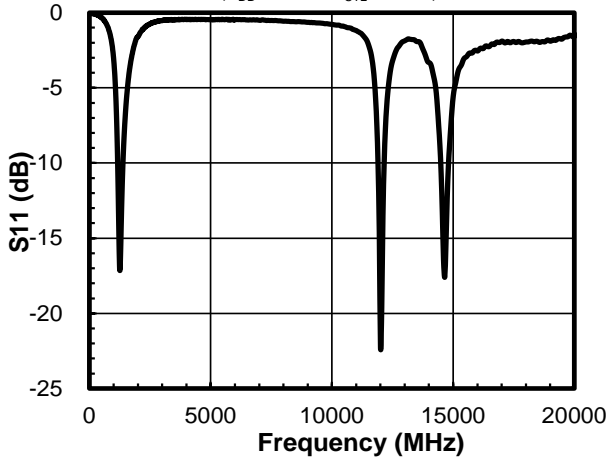

S21 vs. Frequency

( $V_{DD} = 2.8\text{ V}$ ,  $V_{CTL} = 1.8\text{ V}$ )

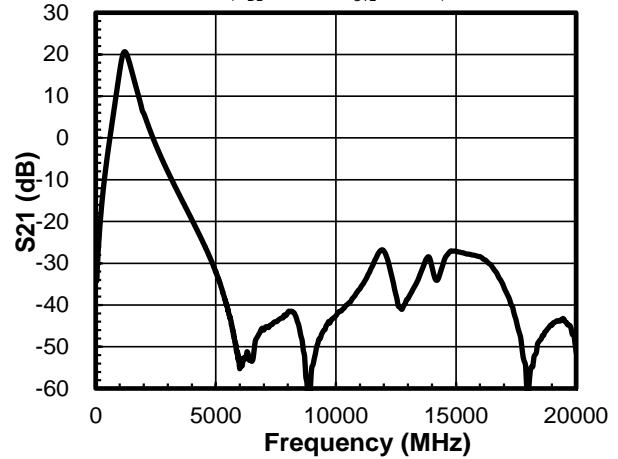

S22 vs. Frequency

( $V_{DD} = 2.8\text{ V}$ ,  $V_{CTL} = 1.8\text{ V}$ )

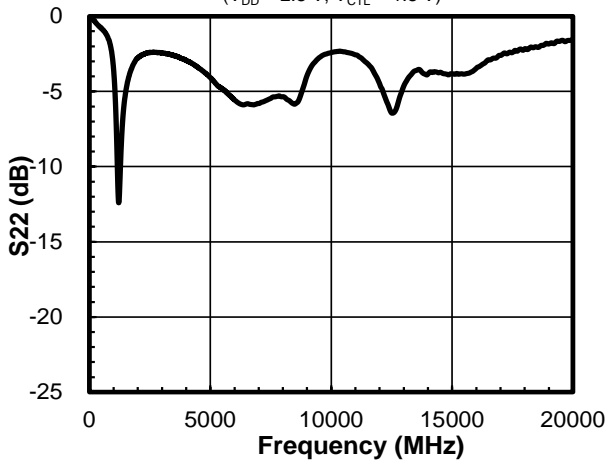

S12 vs. Frequency

( $V_{DD} = 2.8\text{ V}$ ,  $V_{CTL} = 1.8\text{ V}$ )

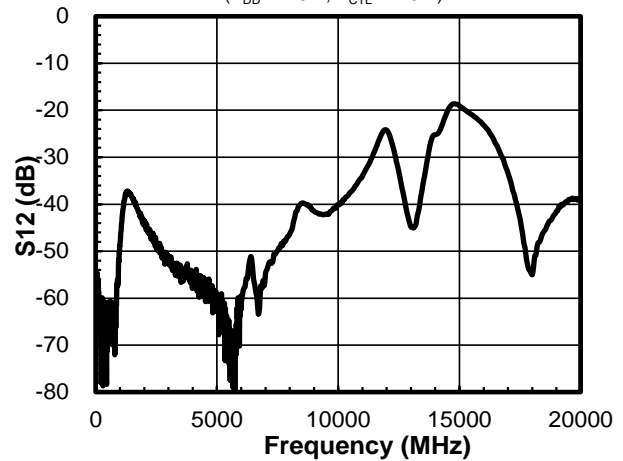

K factor vs. Frequency

( $V_{DD} = 2.8\text{ V}$ ,  $V_{CTL} = 1.8\text{ V}$ )

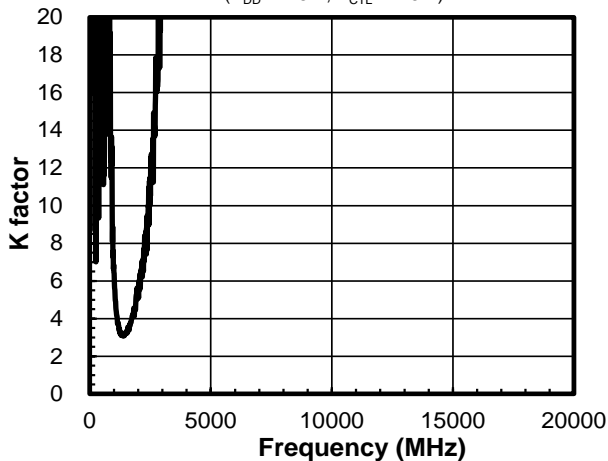

■ TYPICAL CHARACTERISTICS

Conditions:  $V_{DD} = 1.8\text{ V}$ ,  $V_{CTL} = 1.8\text{ V}$ ,  $T_a = 25^\circ\text{C}$ ,  $Z_s = Z_l = 50\ \Omega$ , with application circuit.

(Typical Characteristics are intended to be used as reference data; they are not guaranteed.)

Gain, NF vs. Frequency

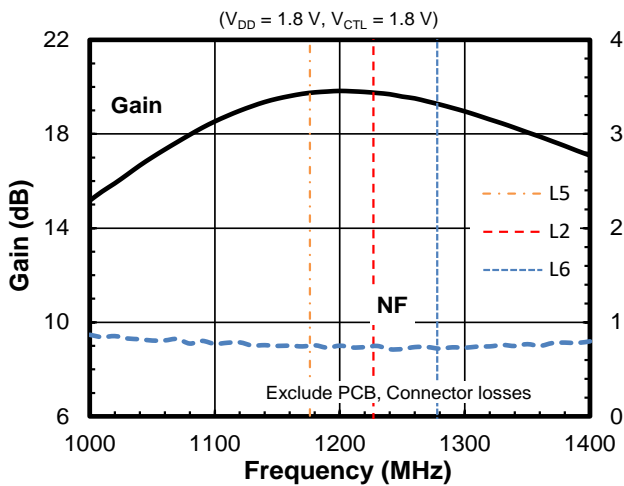

Gain,  $I_{DD}$  vs. Pin

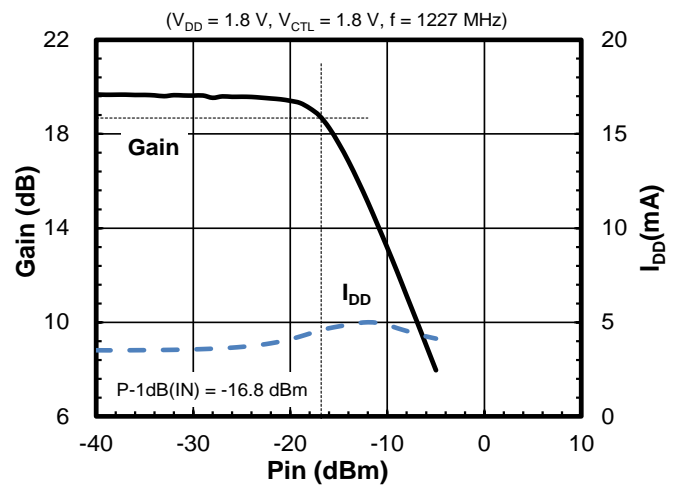

P-1dB(IN) vs. Frequency

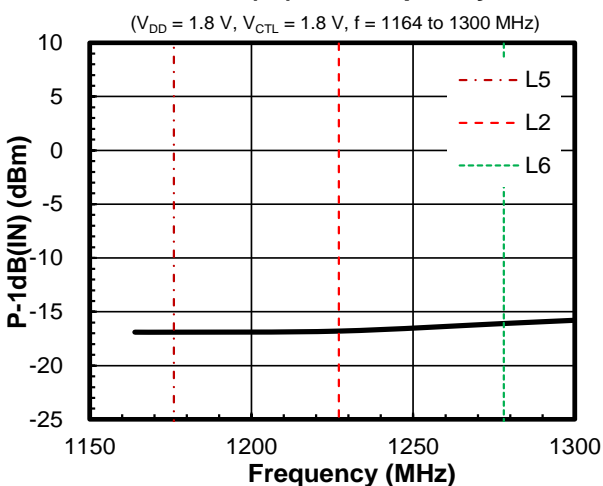

IIP3, OIP3 vs. Frequency

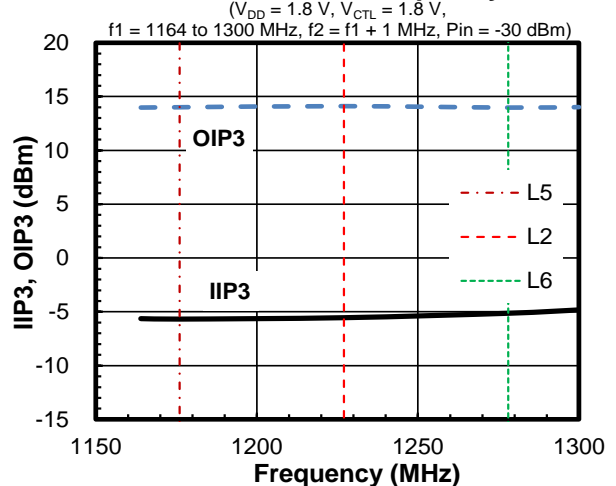

Pout vs. Pin

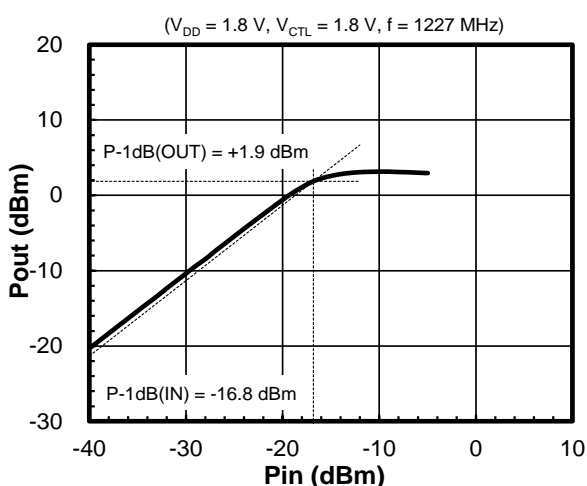

Pout, IM3 vs. Pin

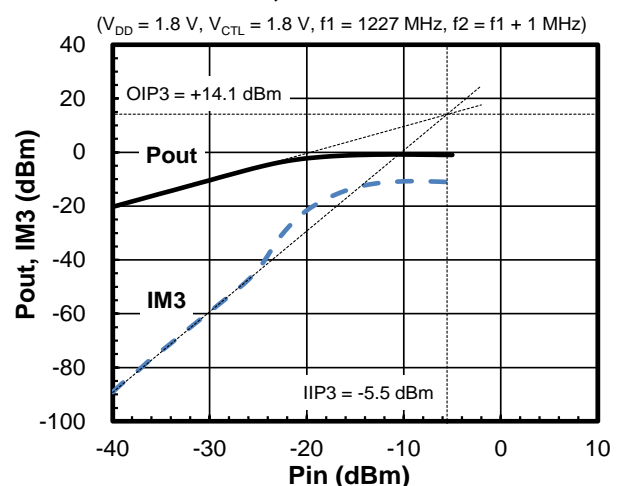

■ TYPICAL CHARACTERISTICS

Conditions:  $V_{DD} = 1.8\text{ V}$ ,  $V_{CTL} = 1.8\text{ V}$ ,  $T_a = 25^\circ\text{C}$ ,  $Z_s = Z_l = 50\ \Omega$ , with application circuit.  
 (Typical Characteristics are intended to be used as reference data; they are not guaranteed.)

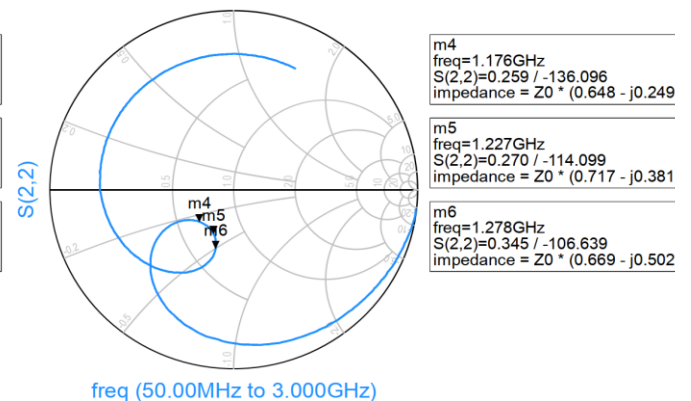
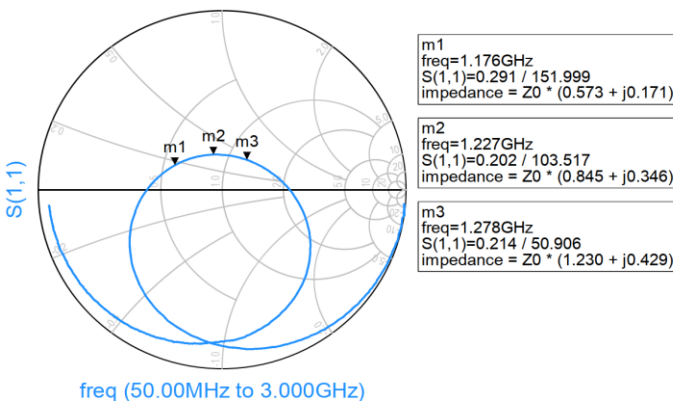
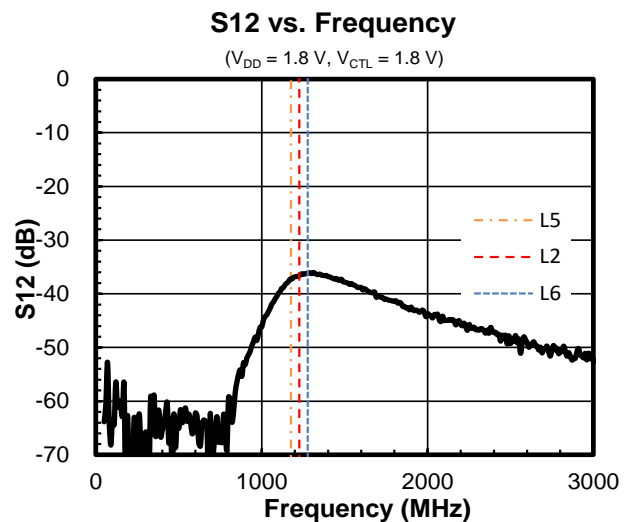
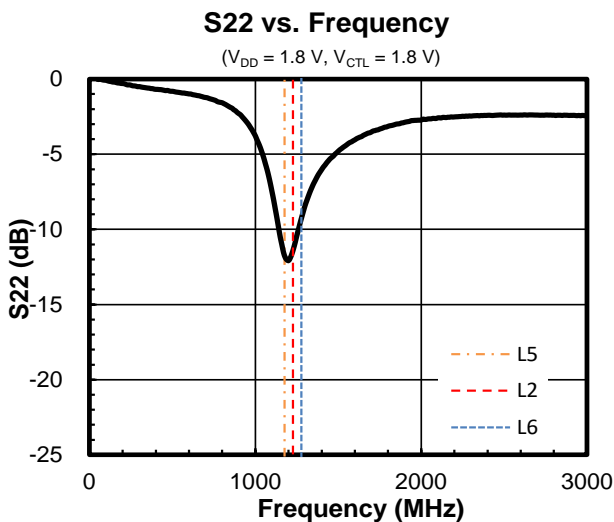
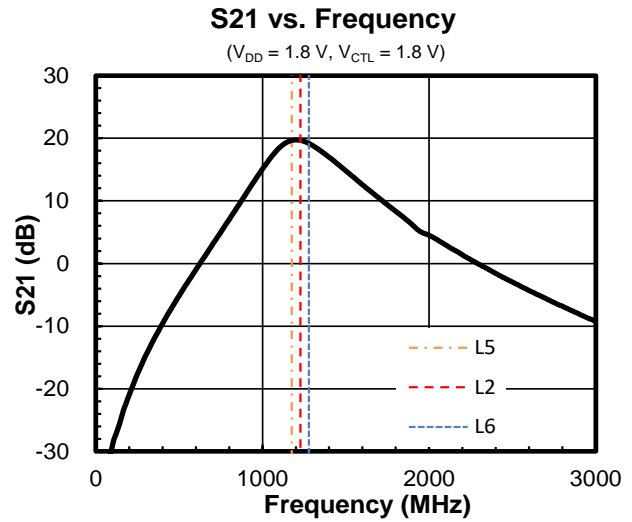
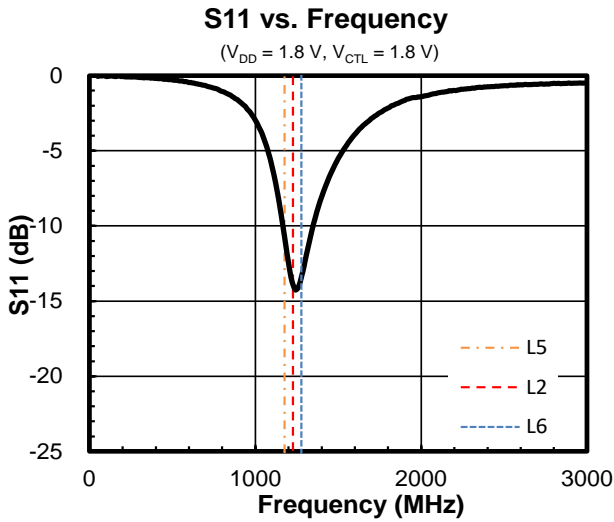

■ TYPICAL CHARACTERISTICS

Conditions:  $V_{DD} = 1.8\text{ V}$ ,  $V_{CTL} = 1.8\text{ V}$ ,  $T_a = 25^\circ\text{C}$ ,  $Z_s = Z_l = 50\ \Omega$ , with application circuit.

(Typical Characteristics are intended to be used as reference data; they are not guaranteed.)

**S11 vs. Frequency**

( $V_{DD} = 1.8\text{ V}$ ,  $V_{CTL} = 1.8\text{ V}$ )

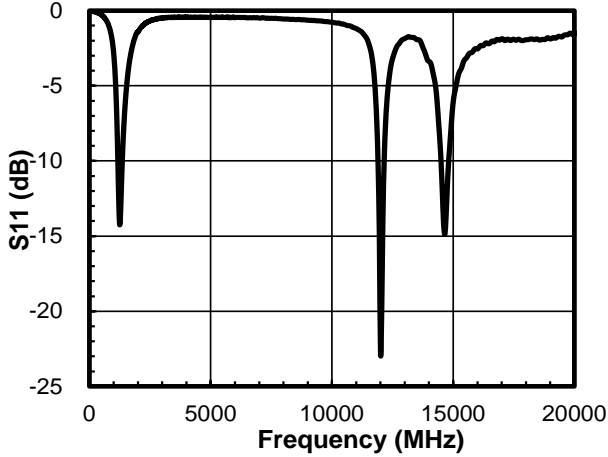

**S21 vs. Frequency**

( $V_{DD} = 1.8\text{ V}$ ,  $V_{CTL} = 1.8\text{ V}$ )

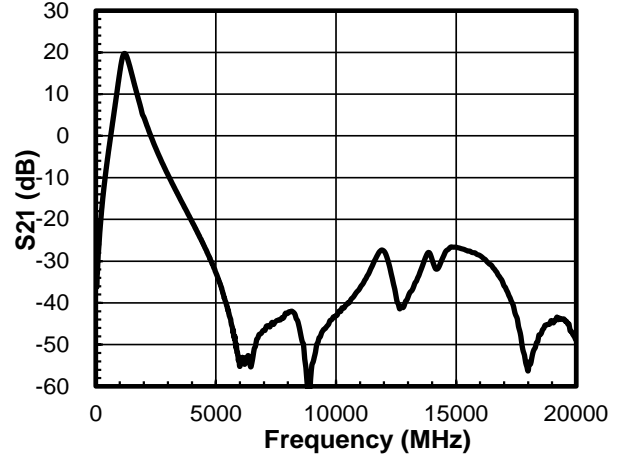

**S22 vs. Frequency**

( $V_{DD} = 1.8\text{ V}$ ,  $V_{CTL} = 1.8\text{ V}$ )

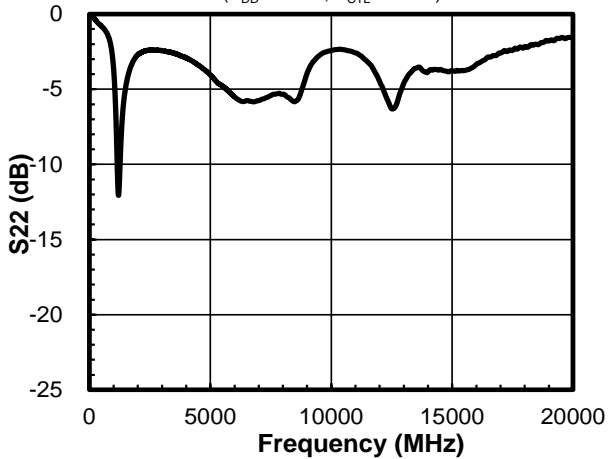

**S12 vs. Frequency**

( $V_{DD} = 1.8\text{ V}$ ,  $V_{CTL} = 1.8\text{ V}$ )

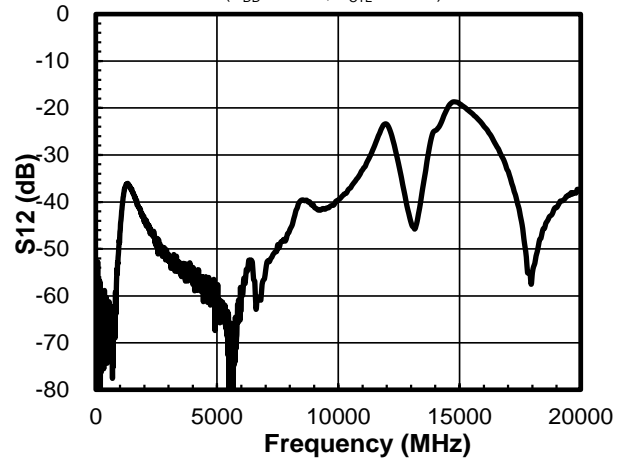

**K factor vs. Frequency**

( $V_{DD} = 1.8\text{ V}$ ,  $V_{CTL} = 1.8\text{ V}$ )

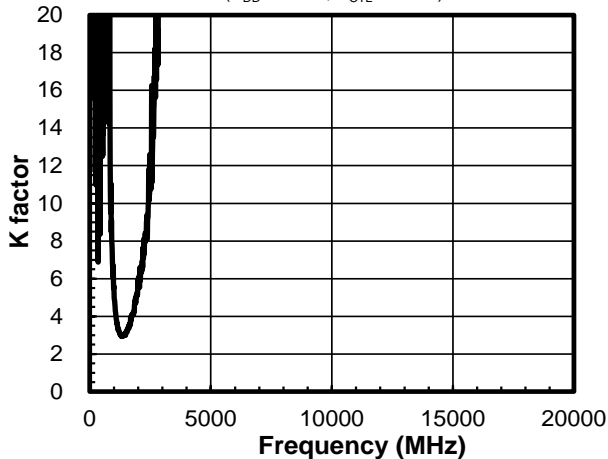

■ TYPICAL CHARACTERISTICS

Conditions:  $T_a = 25^\circ\text{C}$ ,  $Z_s = Z_l = 50 \Omega$ , with application circuit.

(Typical Characteristics are intended to be used as reference data; they are not guaranteed.)

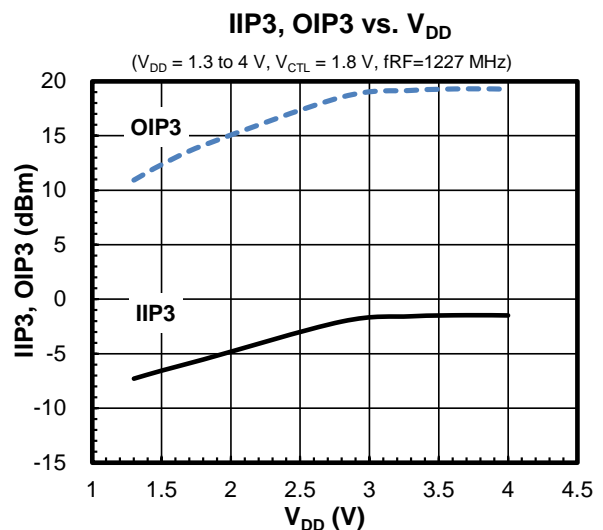
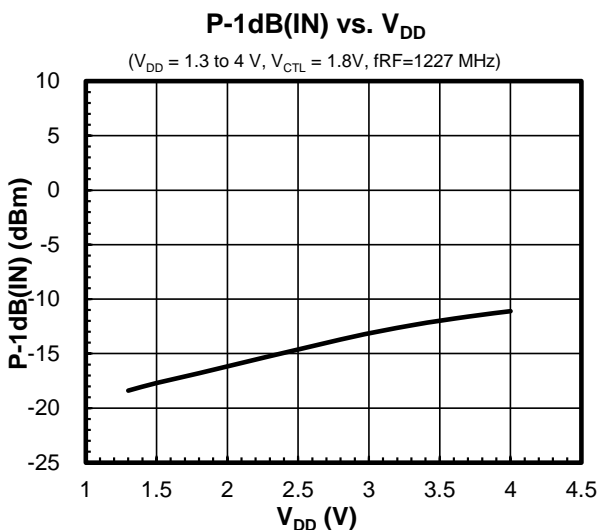
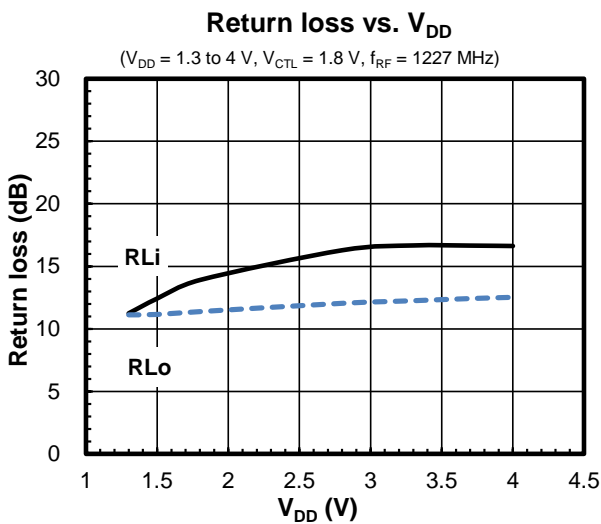
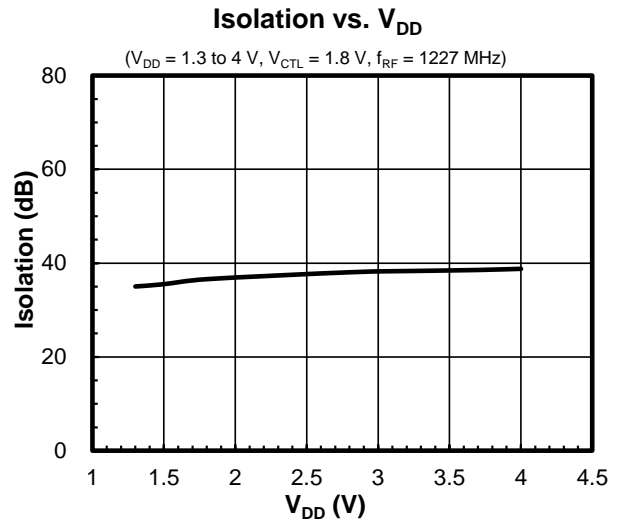
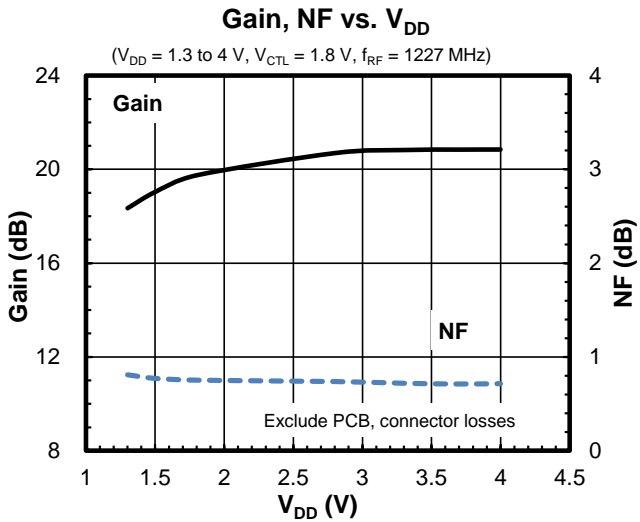

■ TYPICAL CHARACTERISTICS

Conditions:  $V_{DD} = 2.8\text{ V}$ ,  $V_{CTL} = 1.8\text{ V}$ ,  $Z_s = Z_l = 50\ \Omega$ , with application circuit.

(Typical Characteristics are intended to be used as reference data; they are not guaranteed.)

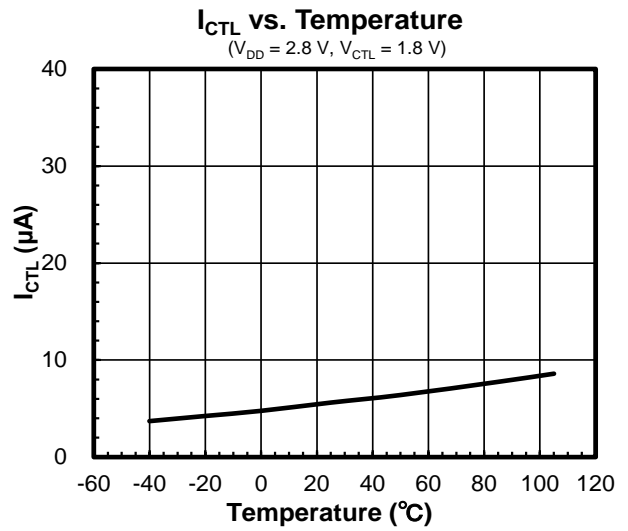
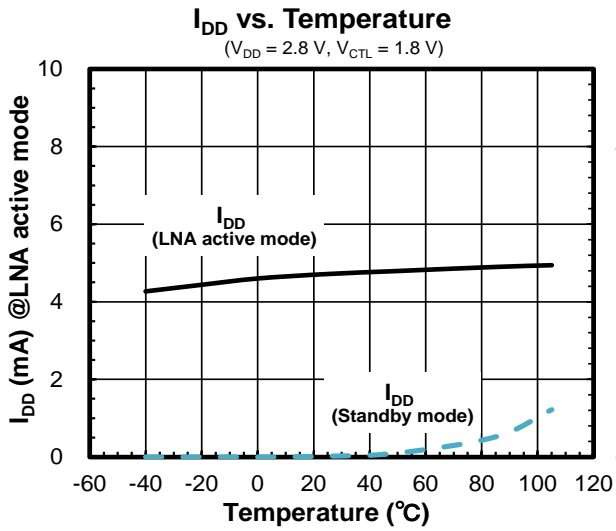

■ TYPICAL CHARACTERISTICS

Conditions:  $V_{DD} = 2.8\text{ V}$ ,  $V_{CTL} = 1.8\text{ V}$ ,  $Z_s = Z_l = 50\ \Omega$ , with application circuit.

(Typical Characteristics are intended to be used as reference data; they are not guaranteed.)

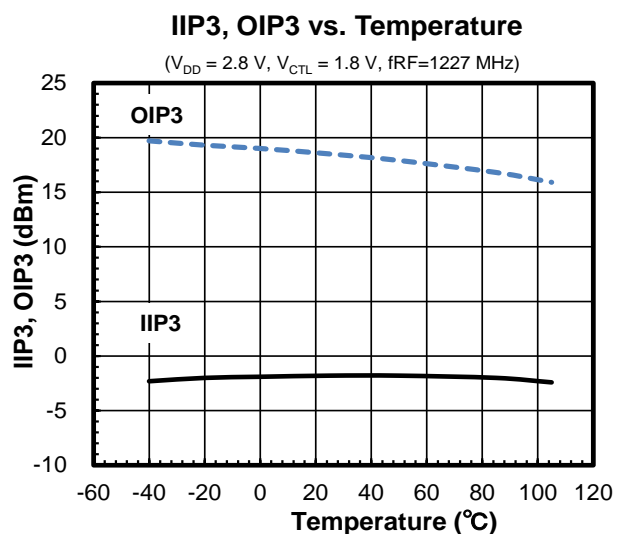
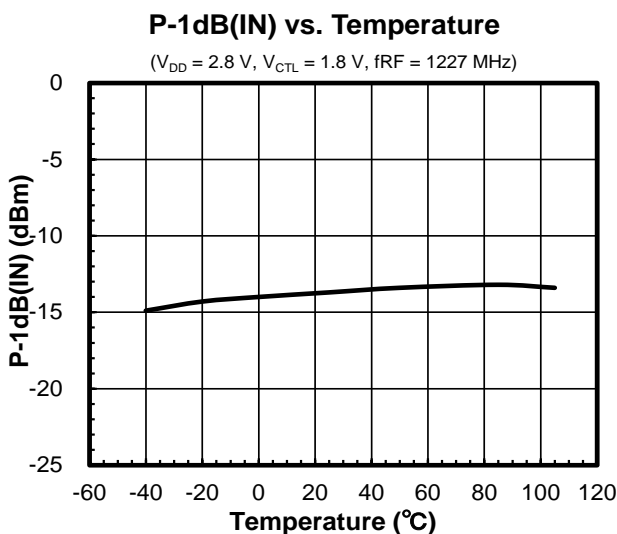
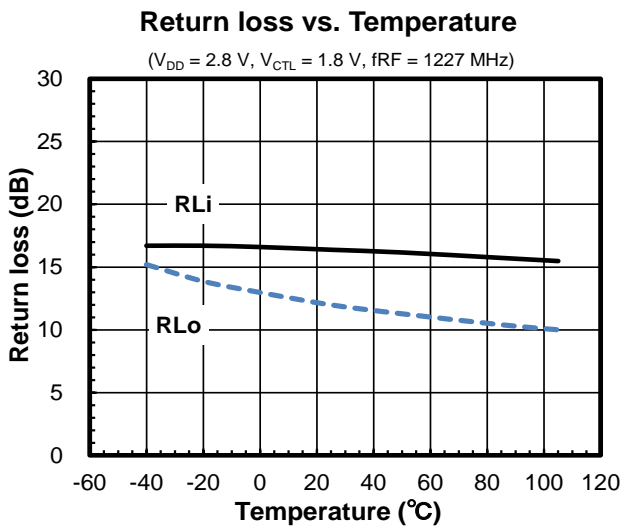
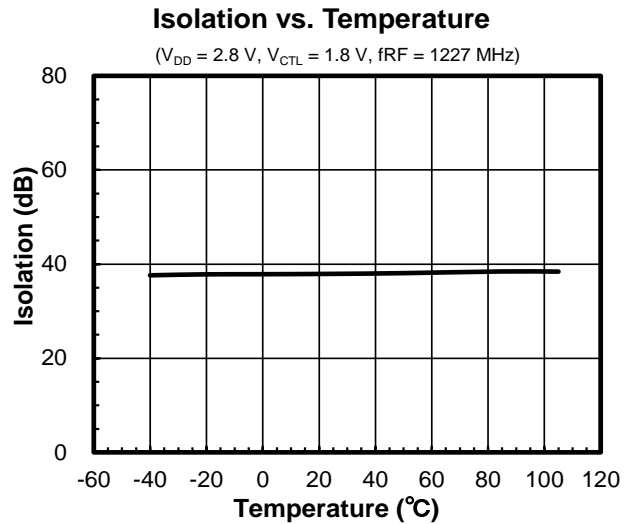
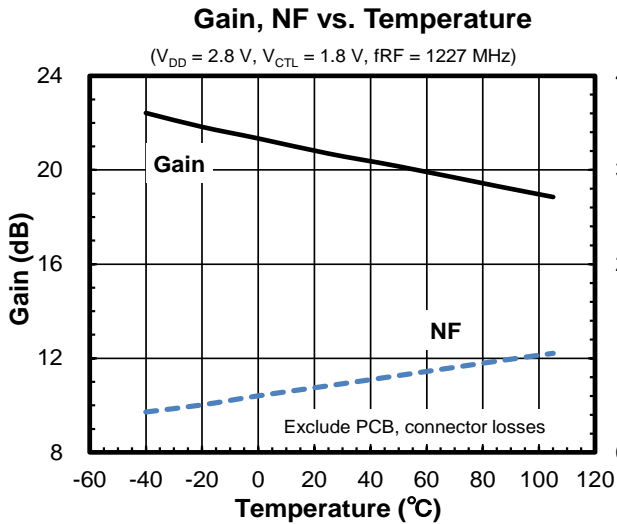

■ TYPICAL CHARACTERISTICS

Conditions:  $V_{DD} = 1.8\text{ V}$ ,  $V_{CTL} = 1.8\text{ V}$ ,  $Z_s = Z_l = 50\ \Omega$ , with application circuit.

(Typical Characteristics are intended to be used as reference data; they are not guaranteed.)

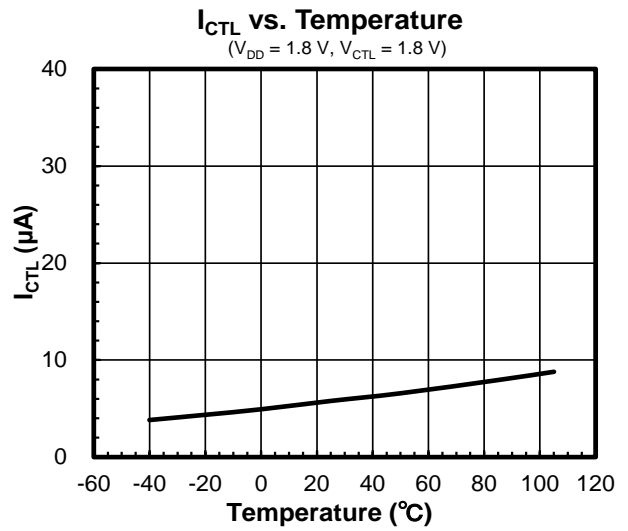
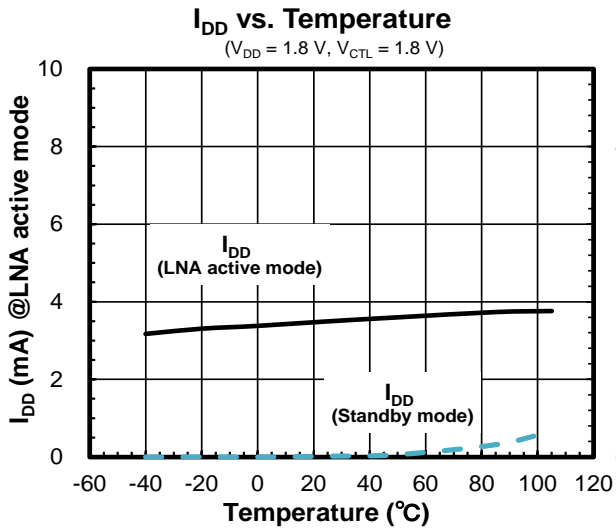

■ TYPICAL CHARACTERISTICS

Conditions:  $V_{DD} = 1.8\text{ V}$ ,  $V_{CTL} = 1.8\text{ V}$ ,  $Z_s = Z_l = 50\ \Omega$ , with application circuit.

(Typical Characteristics are intended to be used as reference data; they are not guaranteed.)

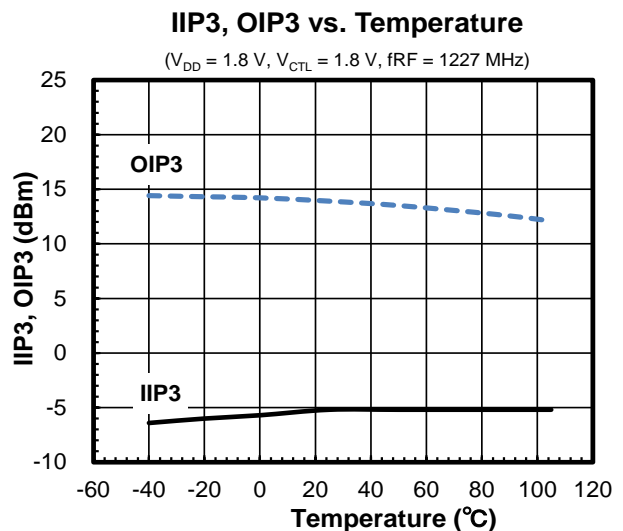
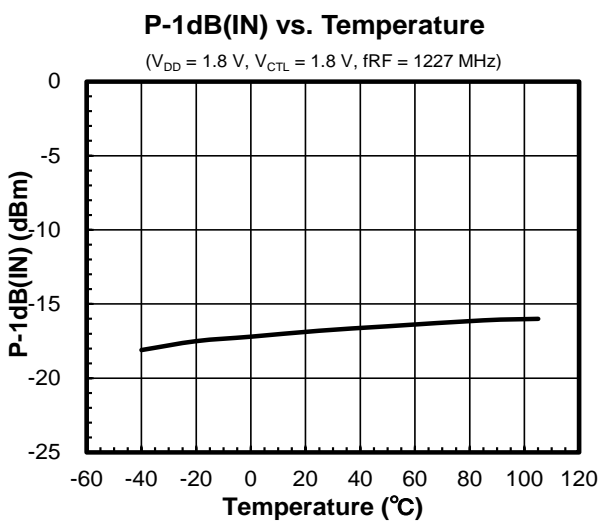
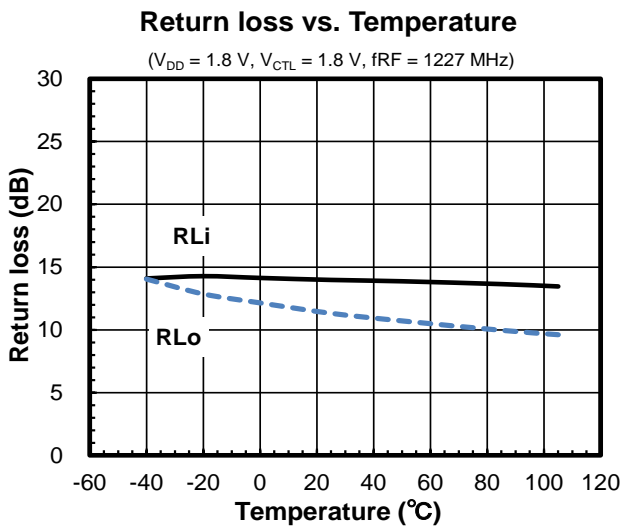
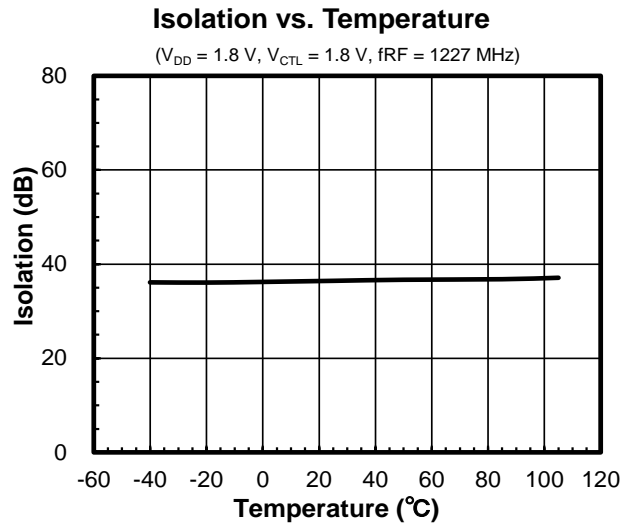
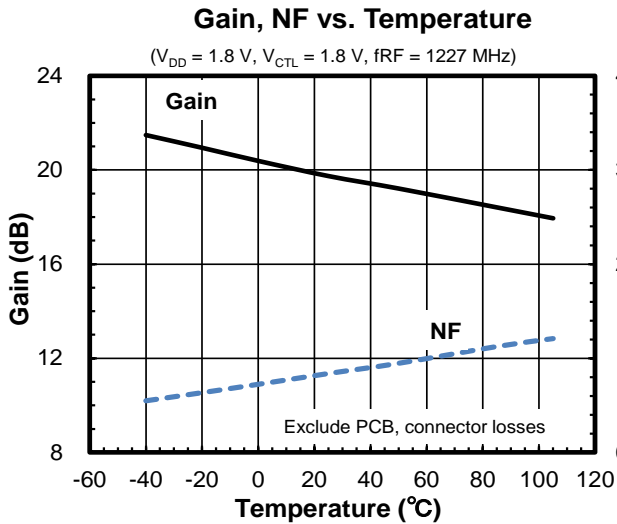

■ APPLICATION CIRCUIT

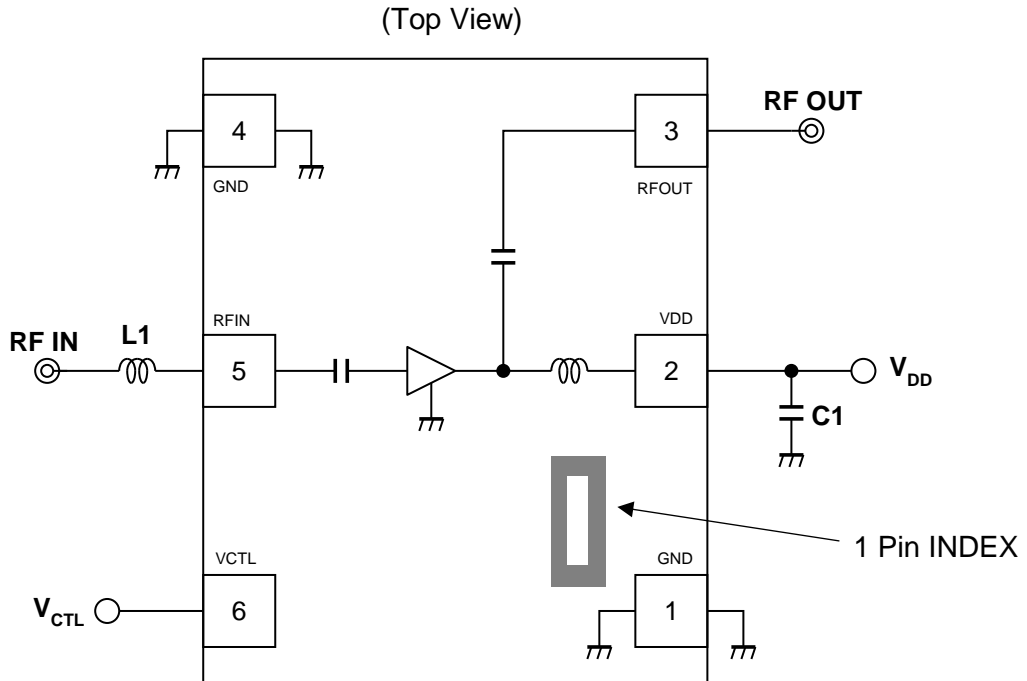

NT1192FAAE1S Typical Application Circuit

<Parts list>

Part ID	Value	Notes
L1	20 nH	LQW15AN_00 series (MURATA)
C1	1000 pF	GRM03 series (MURATA)

■ APPLICATION NOTES

- Evaluation Board / PCB layout

(Top View)

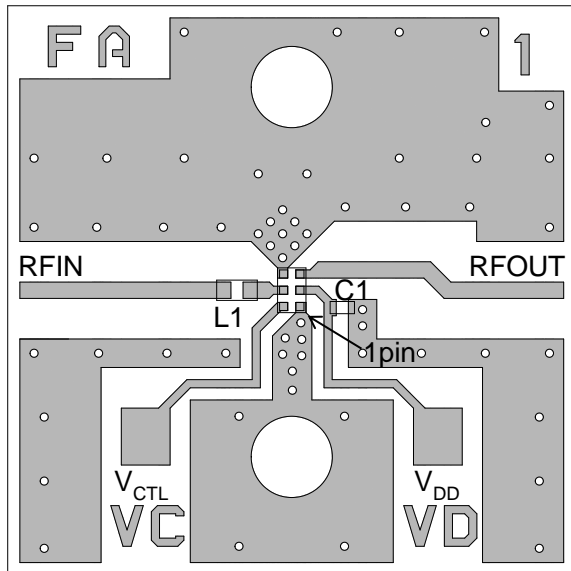

PCB  
 Substrate: FR-4  
 Thickness: 0.2 mm  
 Microstrip line width: 0.4 mm ( $Z_0=50\Omega$ )  
 Size: 14.0 x 14.0 mm

● PCB layout guideline

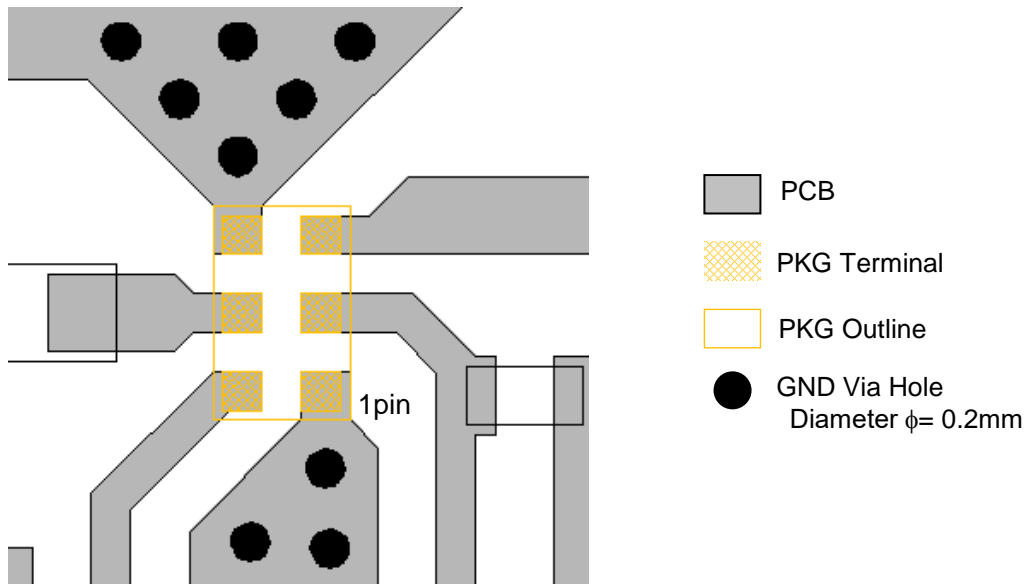

● PRECAUTIONS

- All external parts should be placed as close as possible to the LNA.
- For good RF performance, all GND terminals must be connected to PCB ground plane of substrate, and via-holes for GND should be placed near the LNA.

● NF Measurement Block Diagram

**Measuring instruments**

NF Analyzer : Keysight N8973A

Noise Source : Keysight N4000A

**Setting the NF analyzer**

Measurement mode form

Device under test : Amplifier

System downconverter : off

Mode setup form

Sideband : LSB

Averages : 16

Average mode : Point

Bandwidth : 4 MHz

Loss comp : off

Tcold : setting the temperature of noise source (Auto)

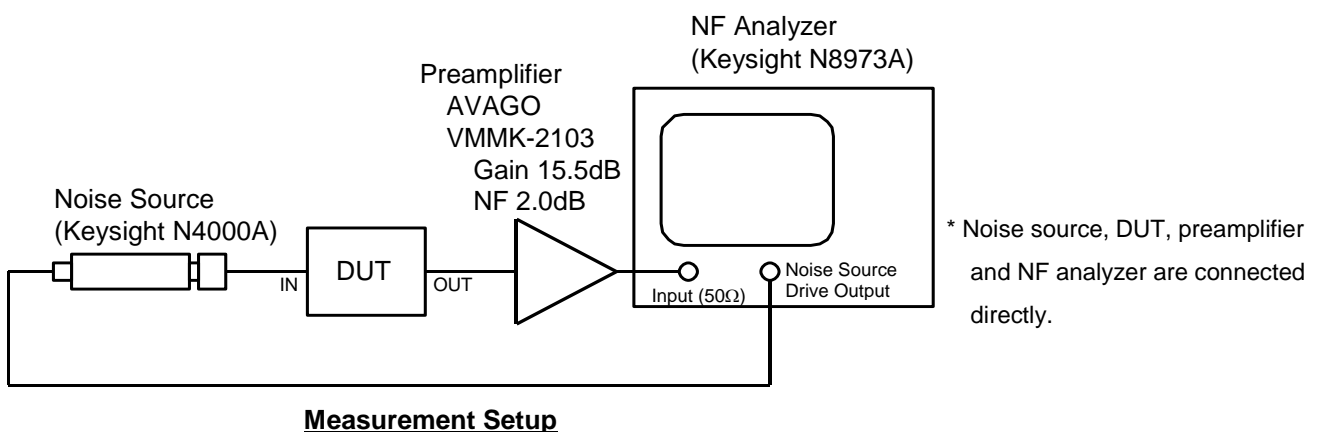
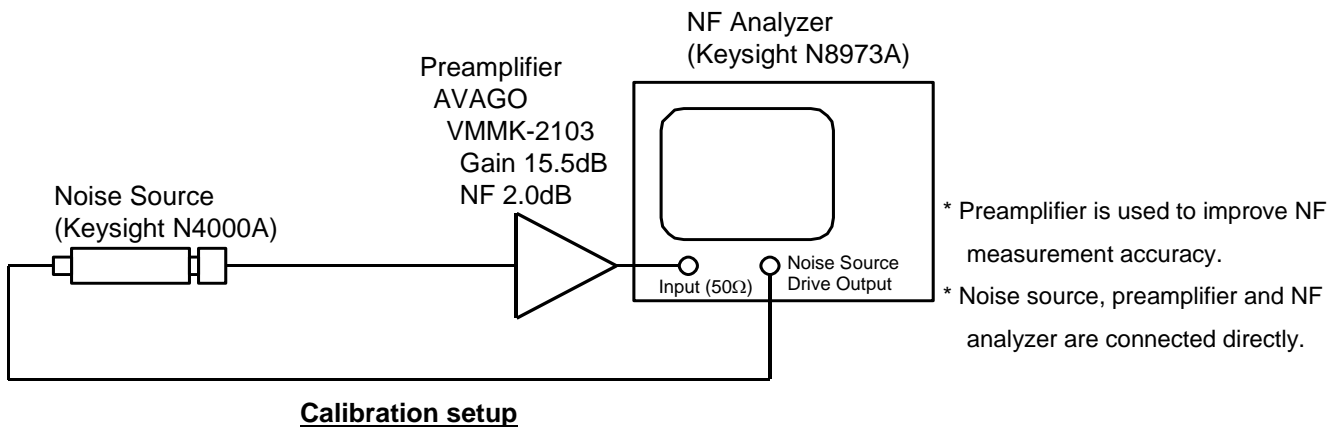

■ PACKAGE DIMENSIONS

UNIT: mm

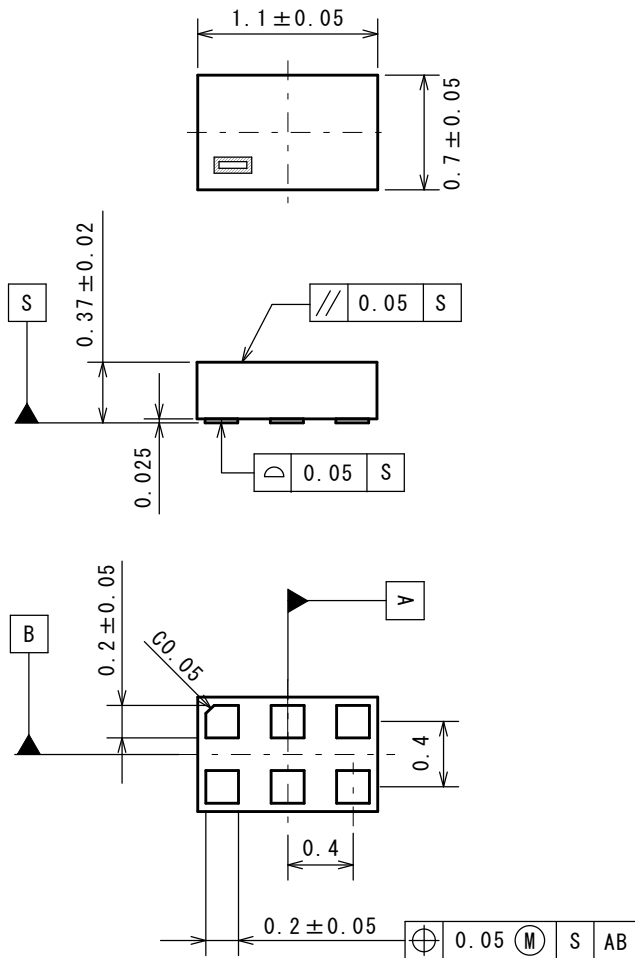

■ EXAMPLE OF SOLDER PADS DIMENSIONS

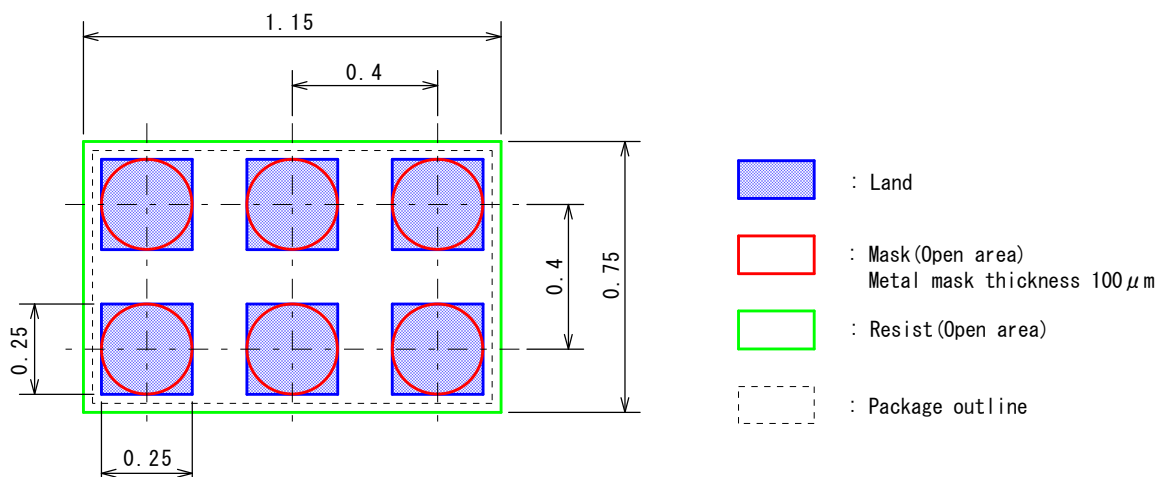



# Nisshinbo Micro Devices Inc.

EPFFP6-FA

Ver. PI-EPFFP6-FA-E-A

## (2) Taping state

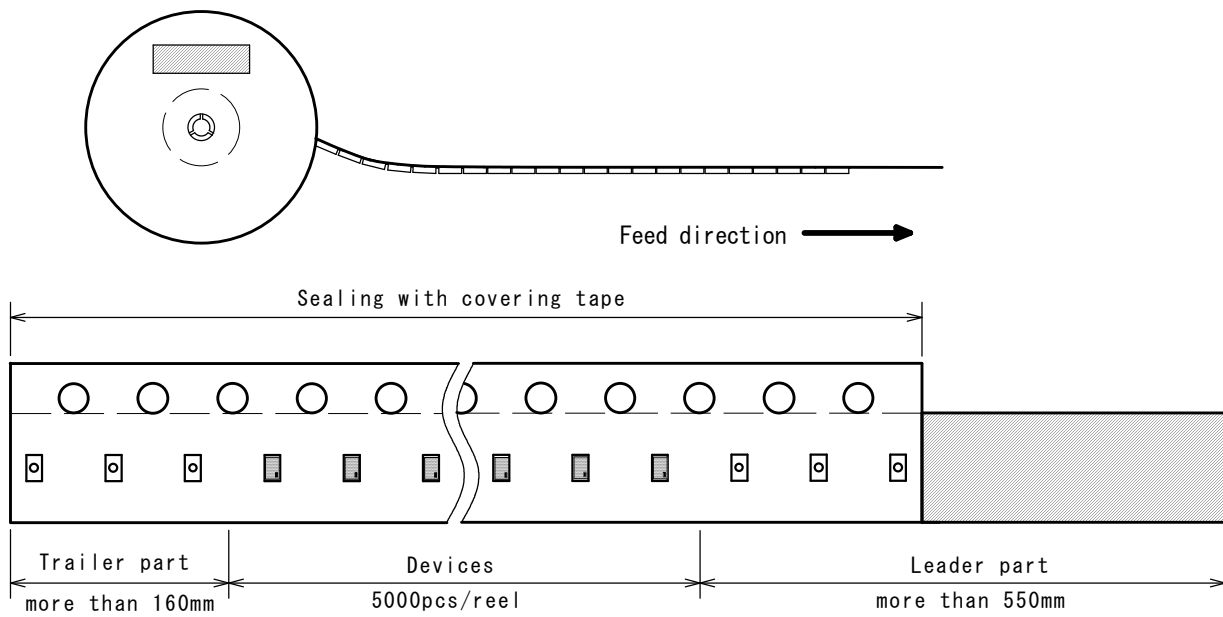

## (3) Reel dimensions

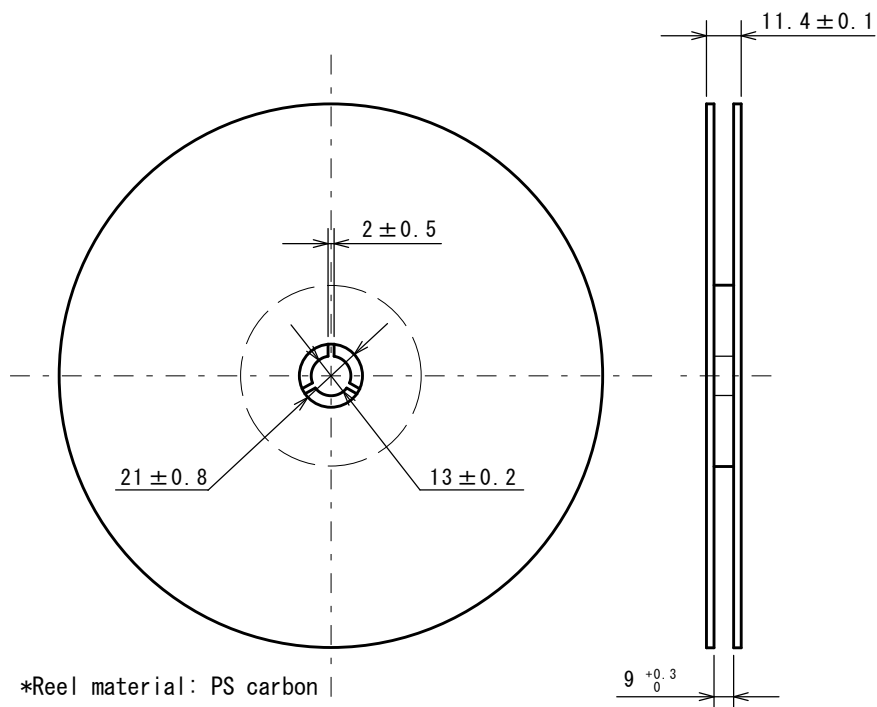

# Nisshinbo Micro Devices Inc.

## EPFFP6-FA

Ver. PI-EPFFP6-FA-E-A

### (4) Peeling strength

Peeling strength of cover tape

- Peeling angle 165~180° degrees to the taped surface.
- Peeling speed 300mm/min
- Peeling strength 0.1~0.7N

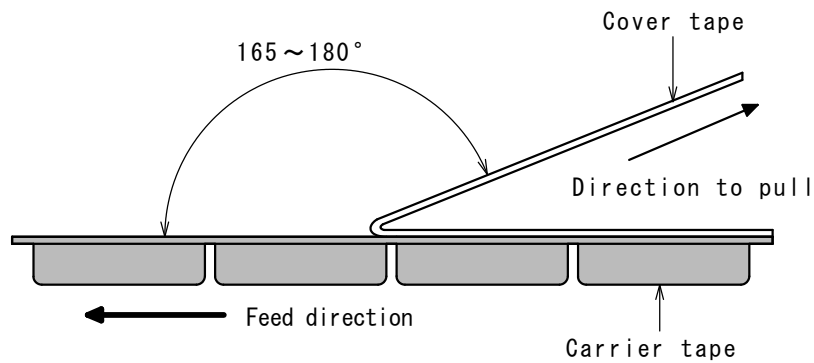

### (5) Packing state

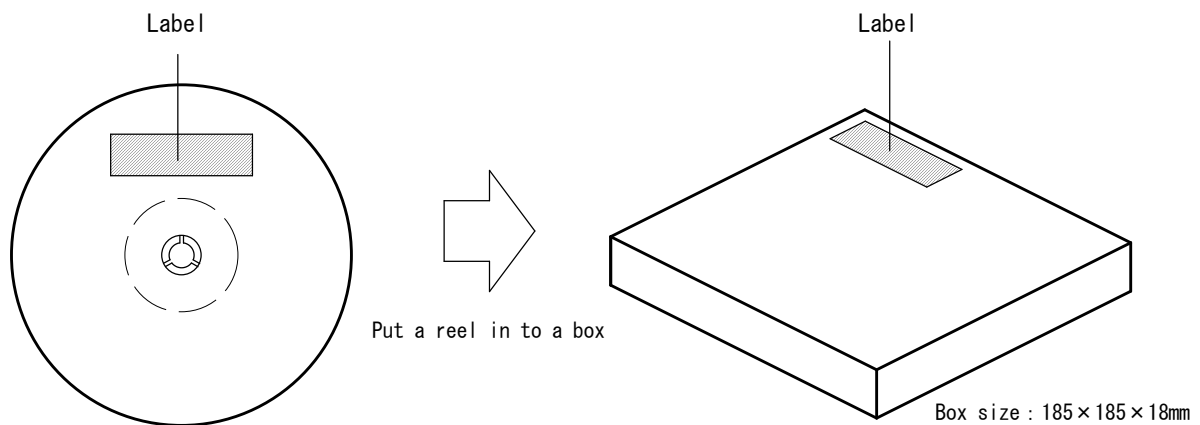

### (6) Label

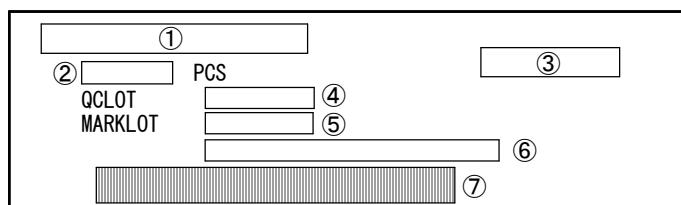

①	Product name
②	Quantity
③	Product code
④	QC LOT No.
⑤	MARK LOT No.
⑥	Environmental notation
⑦	Barcode

1. The products and the product specifications described in this document are subject to change or discontinuation of production without notice for reasons such as improvement. Therefore, before deciding to use the products, please refer to our sales representatives for the latest information thereon.
2. The materials in this document may not be copied or otherwise reproduced in whole or in part without the prior written consent of us.
3. This product and any technical information relating thereto are subject to complementary export controls (so-called KNOW controls) under the Foreign Exchange and Foreign Trade Law, and related politics ministerial ordinance of the law. (Note that the complementary export controls are inapplicable to any application-specific products, except rockets and pilotless aircraft, that are insusceptible to design or program changes.) Accordingly, when exporting or carrying abroad this product, follow the Foreign Exchange and Foreign Trade Control Law and its related regulations with respect to the complementary export controls.
4. The technical information described in this document shows typical characteristics and example application circuits for the products. The release of such information is not to be construed as a warranty of or a grant of license under our or any third party's intellectual property rights or any other rights.
5. The products listed in this document are intended and designed for use as general electronic components in standard applications (office equipment, telecommunication equipment, measuring instruments, consumer electronic products, amusement equipment etc.). Those customers intending to use a product in an application requiring extreme quality and reliability, for example, in a highly specific application where the failure or misoperation of the product could result in human injury or death should first contact us.
  - Aerospace Equipment
  - Equipment Used in the Deep Sea
  - Power Generator Control Equipment (nuclear, steam, hydraulic, etc.)
  - Life Maintenance Medical Equipment
  - Fire Alarms / Intruder Detectors
  - Vehicle Control Equipment (automotive, airplane, railroad, ship, etc.)
  - Various Safety Devices
  - Traffic control system
  - Combustion equipment

In case your company desires to use this product for any applications other than general electronic equipment mentioned above, make sure to contact our company in advance. Note that the important requirements mentioned in this section are not applicable to cases where operation requirements such as application conditions are confirmed by our company in writing after consultation with your company.

6. We are making our continuous effort to improve the quality and reliability of our products, but semiconductor products are likely to fail with certain probability. In order to prevent any injury to persons or damages to property resulting from such failure, customers should be careful enough to incorporate safety measures in their design, such as redundancy feature, fire containment feature and fail-safe feature. We do not assume any liability or responsibility for any loss or damage arising from misuse or inappropriate use of the products.
7. The products have been designed and tested to function within controlled environmental conditions. Do not use products under conditions that deviate from methods or applications specified in this datasheet. Failure to employ the products in the proper applications can lead to deterioration, destruction or failure of the products. We shall not be responsible for any bodily injury, fires or accident, property damage or any consequential damages resulting from misuse or misapplication of the products.
8. **Quality Warranty**
  - 8-1. **Quality Warranty Period**

In the case of a product purchased through an authorized distributor or directly from us, the warranty period for this product shall be one (1) year after delivery to your company. For defective products that occurred during this period, we will take the quality warranty measures described in section 8-2. However, if there is an agreement on the warranty period in the basic transaction agreement, quality assurance agreement, delivery specifications, etc., it shall be followed.
  - 8-2. **Quality Warranty Remedies**

When it has been proved defective due to manufacturing factors as a result of defect analysis by us, we will either deliver a substitute for the defective product or refund the purchase price of the defective product.  
Note that such delivery or refund is sole and exclusive remedies to your company for the defective product.
  - 8-3. **Remedies after Quality Warranty Period**

With respect to any defect of this product found after the quality warranty period, the defect will be analyzed by us. On the basis of the defect analysis results, the scope and amounts of damage shall be determined by mutual agreement of both parties. Then we will deal with upper limit in Section 8-2. This provision is not intended to limit any legal rights of your company.
9. Anti-radiation design is not implemented in the products described in this document.
10. The X-ray exposure can influence functions and characteristics of the products. Confirm the product functions and characteristics in the evaluation stage.
11. WLCSP products should be used in light shielded environments. The light exposure can influence functions and characteristics of the products under operation or storage.
12. Warning for handling Gallium and Arsenic (GaAs) products (Applying to GaAs MMIC, Photo Reflector). These products use Gallium (Ga) and Arsenic (As) which are specified as poisonous chemicals by law. For the prevention of a hazard, do not burn, destroy, or process chemically to make them as gas or power. When the product is disposed of, please follow the related regulation and do not mix this with general industrial waste or household waste.
13. Please contact our sales representatives should you have any questions or comments concerning the products or the technical information.



**Nisshinbo Micro Devices Inc.**

**Official website**



<https://www.nisshinbo-microdevices.co.jp/en/>

**Purchase information**

<https://www.nisshinbo-microdevices.co.jp/en/buy/>

## Looking for pricing, stock, or lifecycle information?

Click below to explore more details on WIN SOURCE:

-  [View NT1192FAAE1S on WIN SOURCE](#)
-  [Nisshinbo Micro Devices Inc. Information](#)

## Optimize Your Supply Chain with WIN SOURCE Solutions

-  Global Sourcing Solution
-  Obsolete Management
-  Cost Control Management
-  Shortage Management
-  Alternative Solution
-  Excess Inventory Management