



THE DATASHEET OF CMD244K5



CMD244K5 Product Overview

The CMD244K5 is wideband GaAs MMIC distributed amplifier which operates from DC to 20 GHz and is housed in a leadless surface mount package. The amplifier delivers greater than 17 dB of gain with a corresponding output 1 dB compression point of +25 dBm and noise figure of 2.5 dB at 10 GHz. The CMD244K5 is a 50 ohm matched design which eliminates the need for RF port matching.

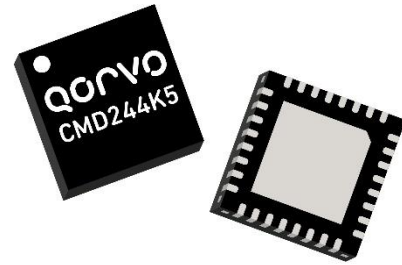

Functional Block Diagram

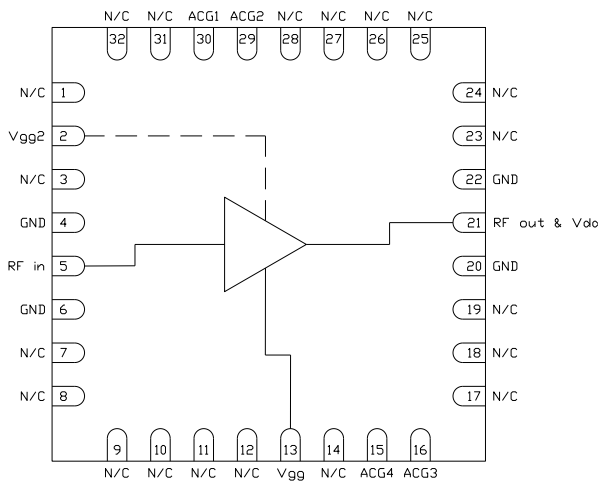

Note: V_{gg2} is optional for gain control

Key Features

- Ultra Wideband Performance
- Positive Gain Slope
- High Output Power
- Low Noise Figure
- Pb-Free RoHS Compliant 5x5 mm SMT Package

Ordering Information

Part No.	Description
CMD244K5	DC-20 GHz Distributed Driver Amplifier, 100 Piece 7" Reel
CMD244K5-EVB	Evaluation Board

Electrical Performance ($V_{dd} = 8.0 \text{ V}$, $V_{gg} = -1.0 \text{ V}$, $T_A = 25 \text{ }^\circ\text{C}$, $F = 10 \text{ GHz}$)

Parameter	Min	Typ	Max	Units
Frequency Range		DC - 20		GHz
Gain		17.5		dB
Noise Figure		2.5		dB
Input Return Loss		20		dB
Output Return Loss		18		dB
Output P1dB		25		dBm
Output IP3		31		dBm
Supply Current		185		mA

Absolute Maximum Ratings

Parameter	Rating
Drain Voltage, V_{dd}	10 V
Gate Voltage, V_{gg}	-4 to 0 V
RF Input Power	+23 dBm
Channel Temperature, T_{ch}	150 °C
Power Dissipation, P_{diss}	2.4 W
Thermal Resistance, θ_{JC}	26.82 °C/W
Operating Temperature	-40 to 85 °C
Storage Temperature	-55 to 150 °C

Exceeding any one or combination of the maximum ratings may cause permanent damage to the device.

Recommended Operating Conditions

Parameter	Min	Typ	Max	Units
V_{dd}	5.0	8.0	8.5	V
I_{dd}		185		mA
V_{gg}	-4.0	-1.0	0	V
I_{gg}		-1.6		mA

Electrical performance is measured at specific test conditions. Electrical specifications are not guaranteed over all recommended operating conditions.

Drain Current vs. Drain Voltage

V_{dd} (V)	I_{dd} (mA)
5.0	167
6.0	172
7.0	177

Electrical Specifications ($V_{dd} = 8.0$ V, $V_{gg} = -1.0$ V, $T_A = 25$ °C)

Parameter	Min	Typ	Max	Min	Typ	Max	Units
Frequency Range	DC - 10			10 - 20			GHz
Gain	14	17		14.5	17.5		dB
Noise Figure		3			3.5		dB
Input Return Loss		18			13		dB
Output Return Loss		25			18		dB
Output P1dB	22	25		19.5	24		dBm
Output IP3		33			29		dBm
Supply Current	130	185	270	130	185	270	mA
Gain Temperature Coefficient		0.010			0.014		dB/°C
Noise Figure Temperature Coefficient		0.008			0.011		dB/°C

Typical Performance

Broadband Performance, $V_{dd} = 8.0\text{ V}$, $V_{gg} = -1.0\text{ V}$, $T_A = 25\text{ }^\circ\text{C}$

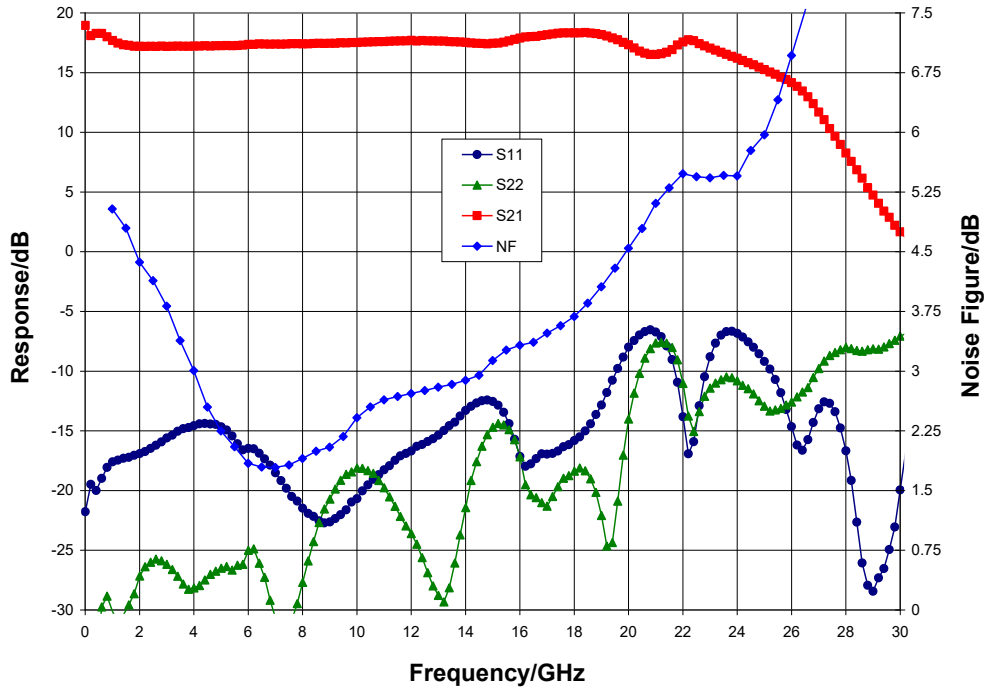

Narrow-band Performance, $V_{dd} = 8.0\text{ V}$, $V_{gg} = -1.0\text{ V}$, $T_A = 25\text{ }^\circ\text{C}$

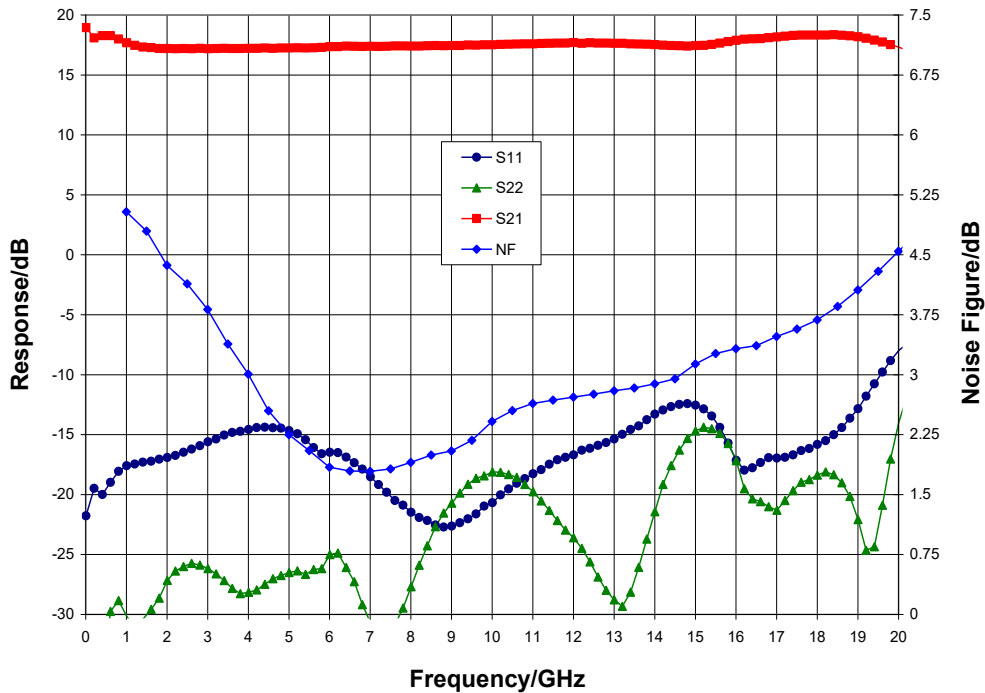

Typical Performance

Gain vs. Temperature, $V_{dd} = 8.0\text{ V}$, $V_{gg} = -1.0\text{ V}$

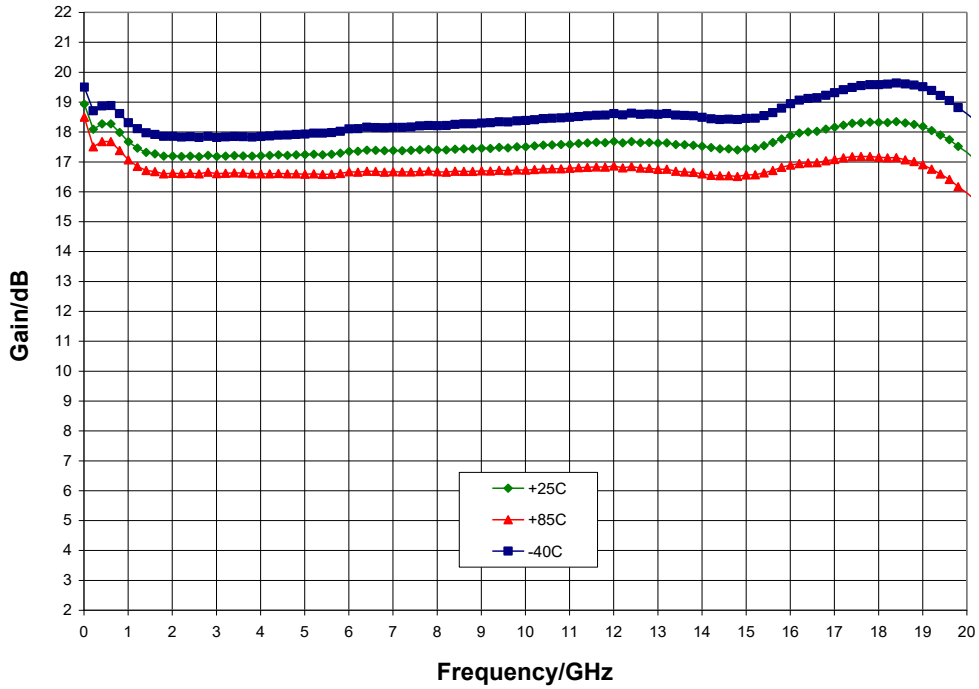

Gain vs. V_{dd} , $T_A = 25\text{ }^\circ\text{C}$

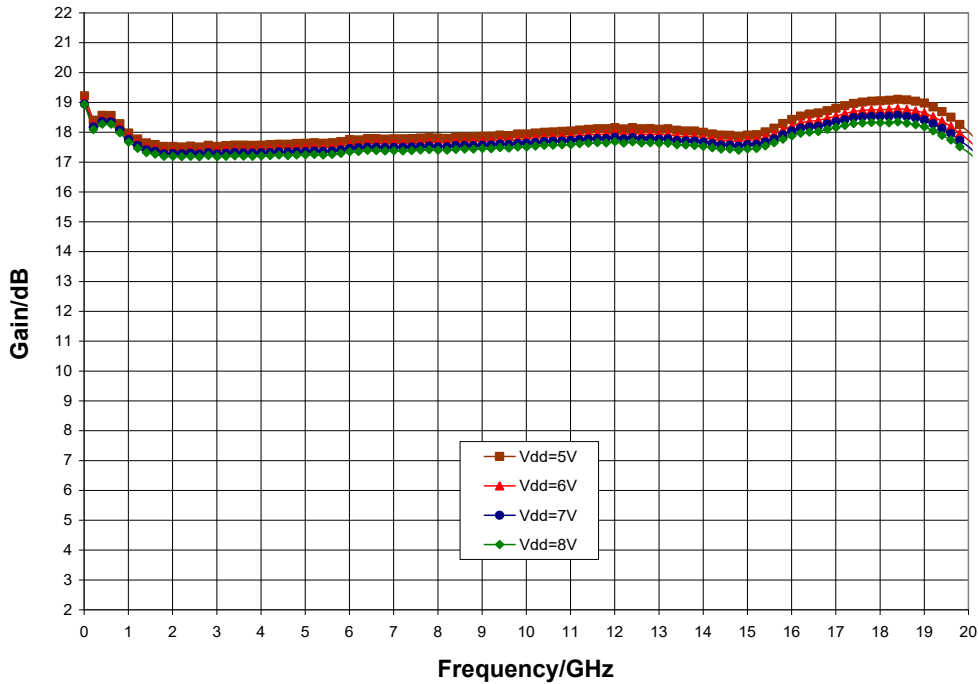

Typical Performance

Noise Figure vs. Temperature, $V_{dd} = 8.0\text{ V}$, $V_{gg} = -1.0\text{ V}$

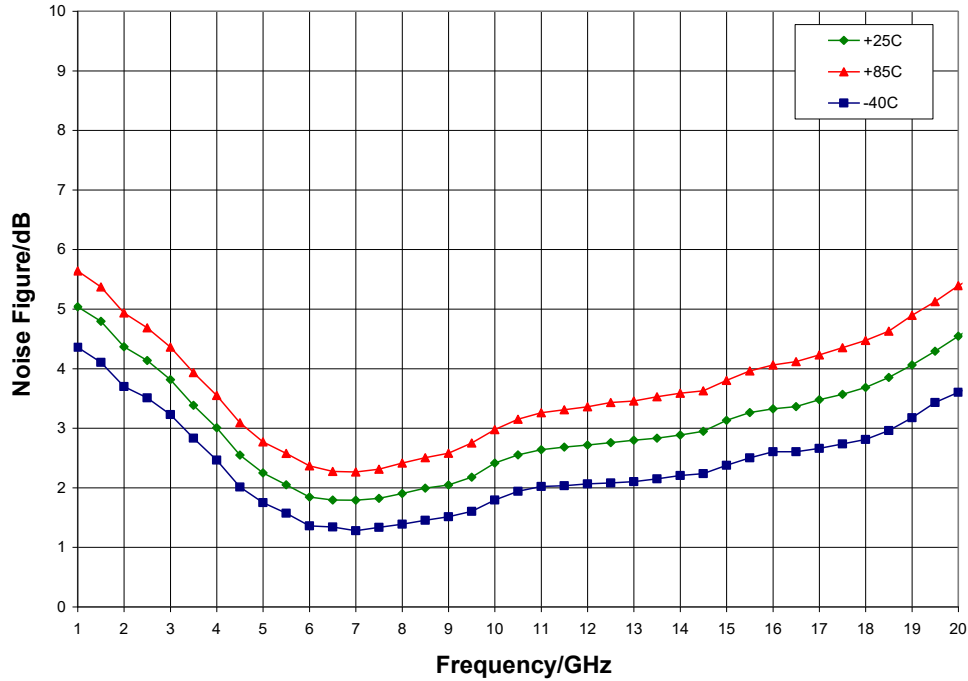

Noise Figure vs. V_{dd} , $T_A = 25\text{ }^\circ\text{C}$

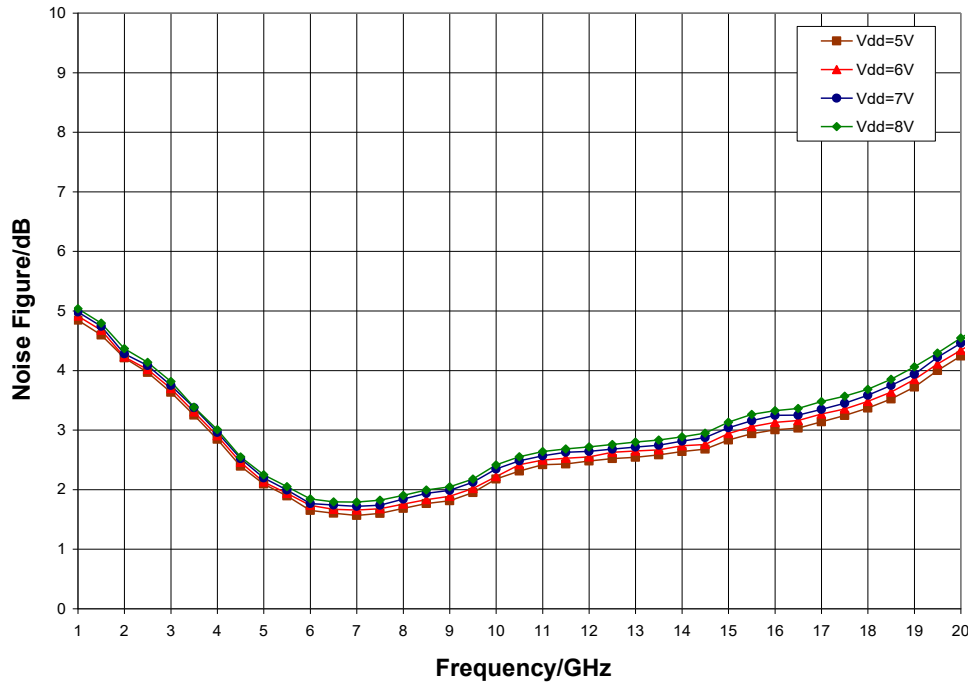

Typical Performance

P1dB vs. Temperature, $V_{dd} = 8.0\text{ V}$, $V_{gg} = -1.0\text{ V}$

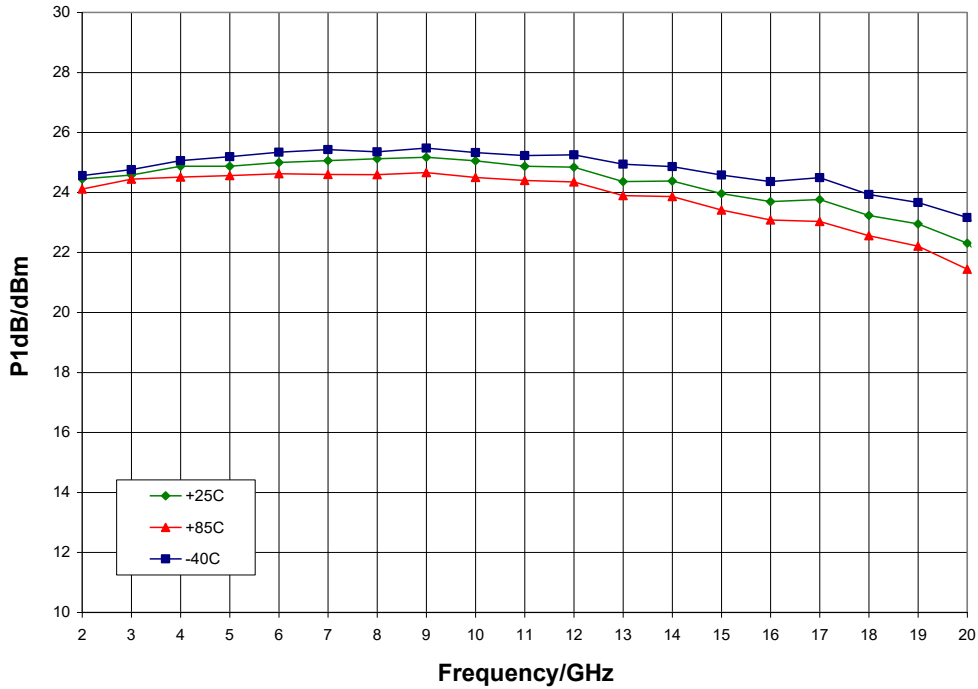

P1dB vs. V_{dd} , $T_A = 25\text{ }^\circ\text{C}$

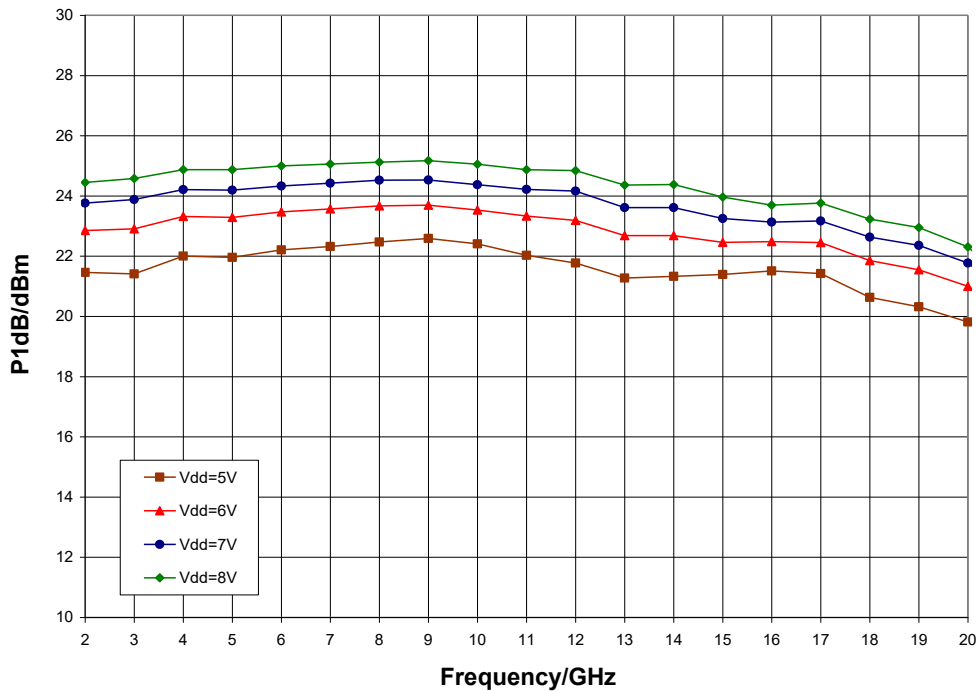

Typical Performance

Psat vs. Temperature, $V_{dd} = 8.0\text{ V}$, $V_{gg} = -1.0\text{ V}$

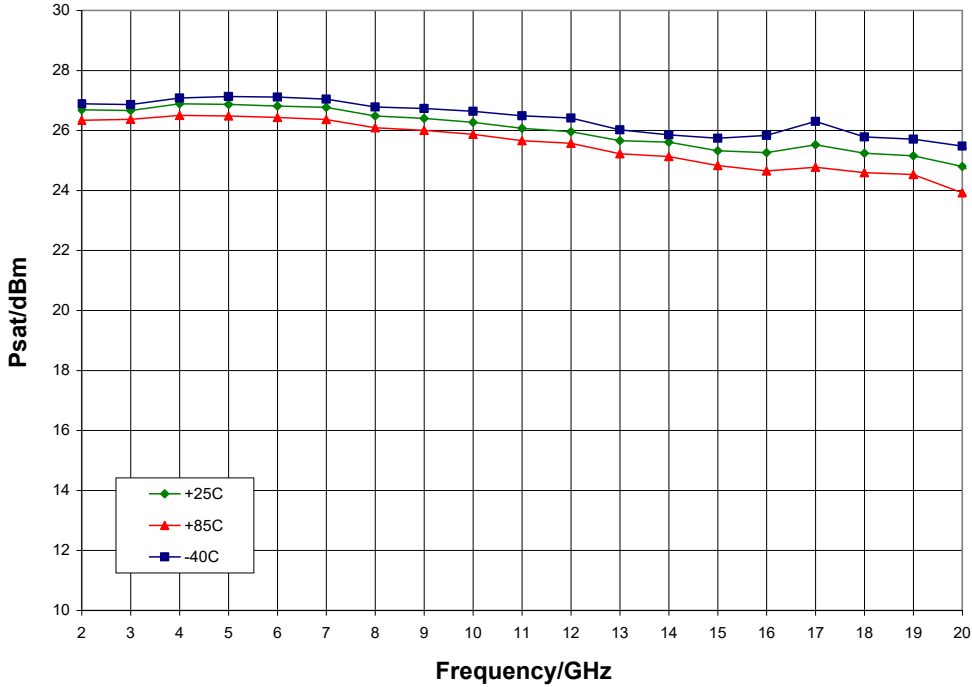

Psat vs. V_{dd} , $T_A = 25\text{ }^\circ\text{C}$

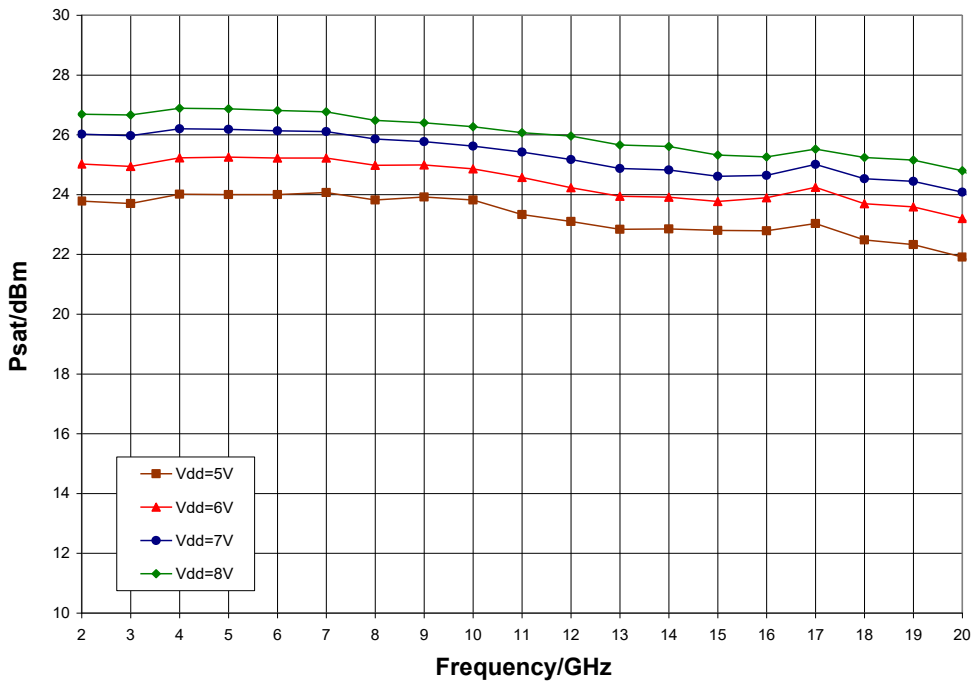

Typical Performance

Output IP3 vs. Temperature, $V_{dd} = 8.0\text{ V}$, $V_{gg} = -1.0\text{ V}$

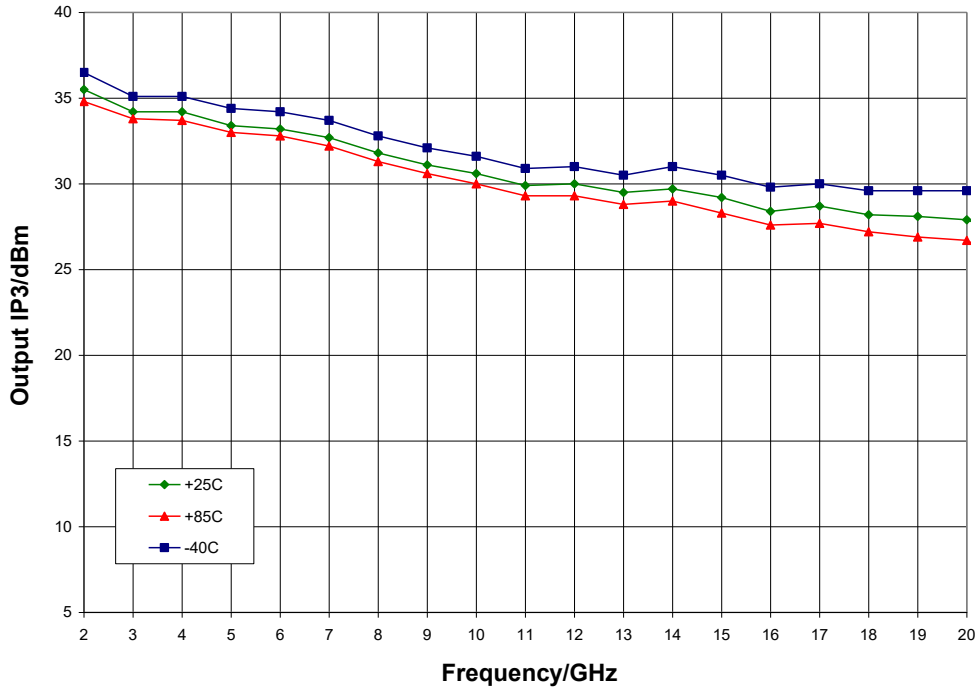

Output IP3 vs. V_{dd} , $T_A = 25\text{ }^\circ\text{C}$

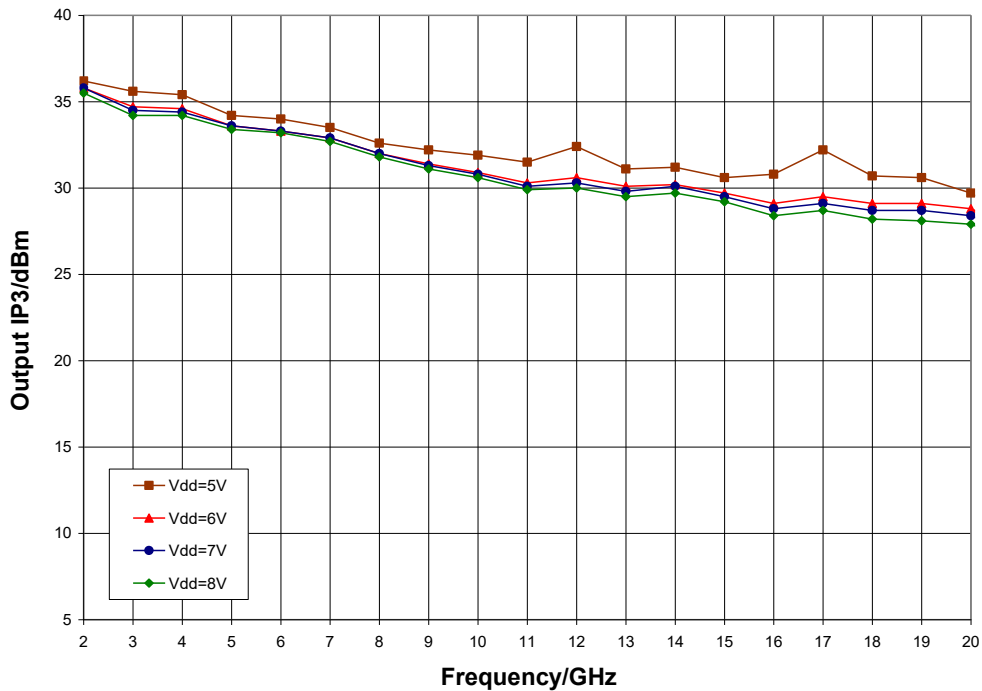

Typical Performance

Output IP2 vs. Temperature, $V_{dd} = 8.0\text{ V}$, $V_{gg} = -1.0\text{ V}$

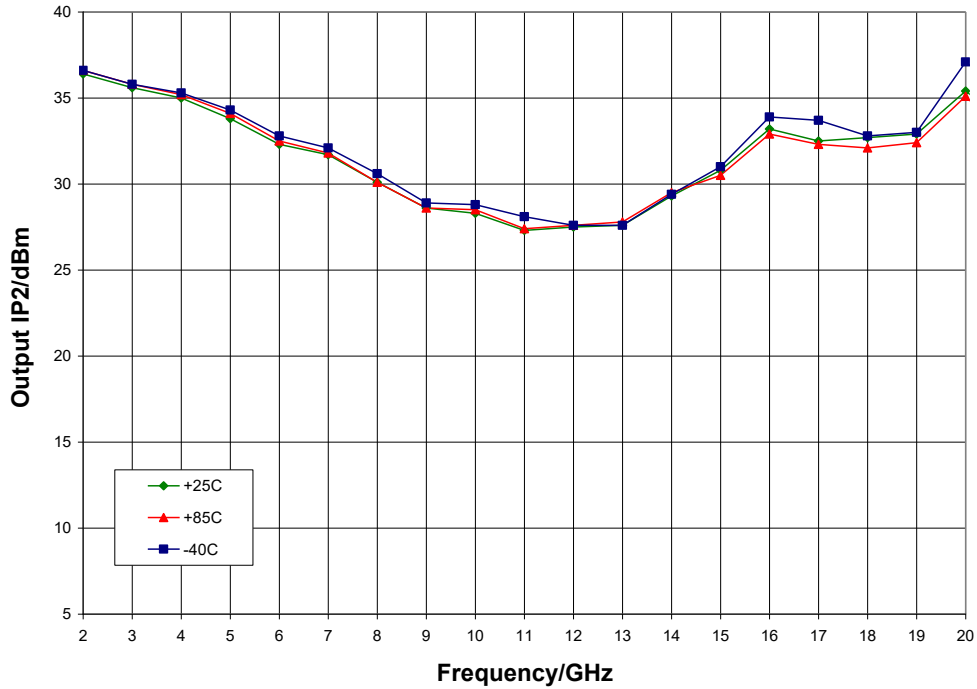

Output IP2 vs. V_{dd} , $T_A = 25\text{ }^\circ\text{C}$

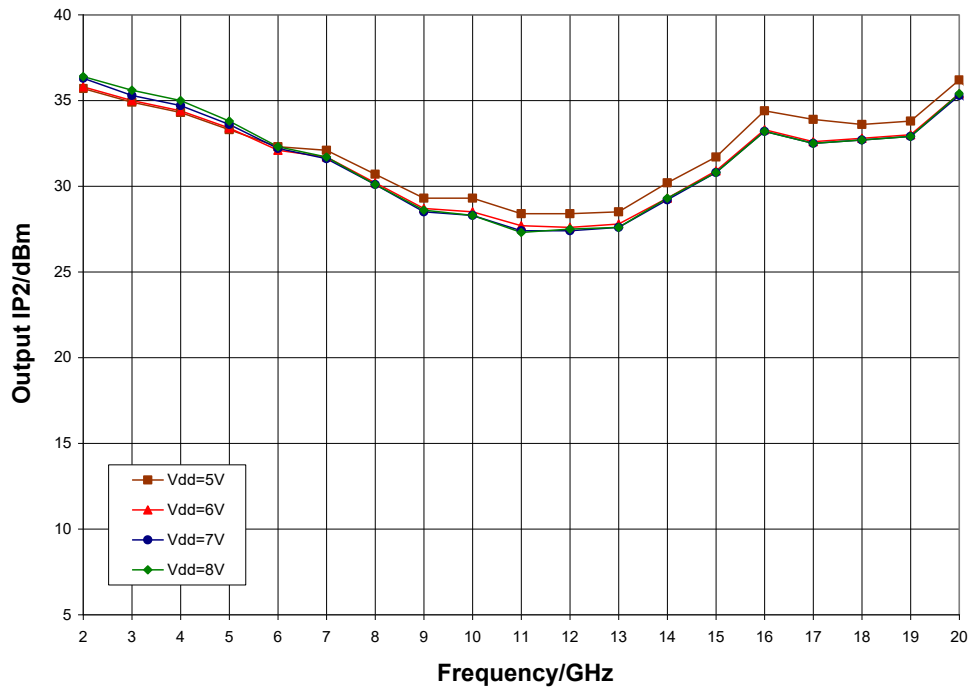

Mechanical Information

Package Information and Dimensions

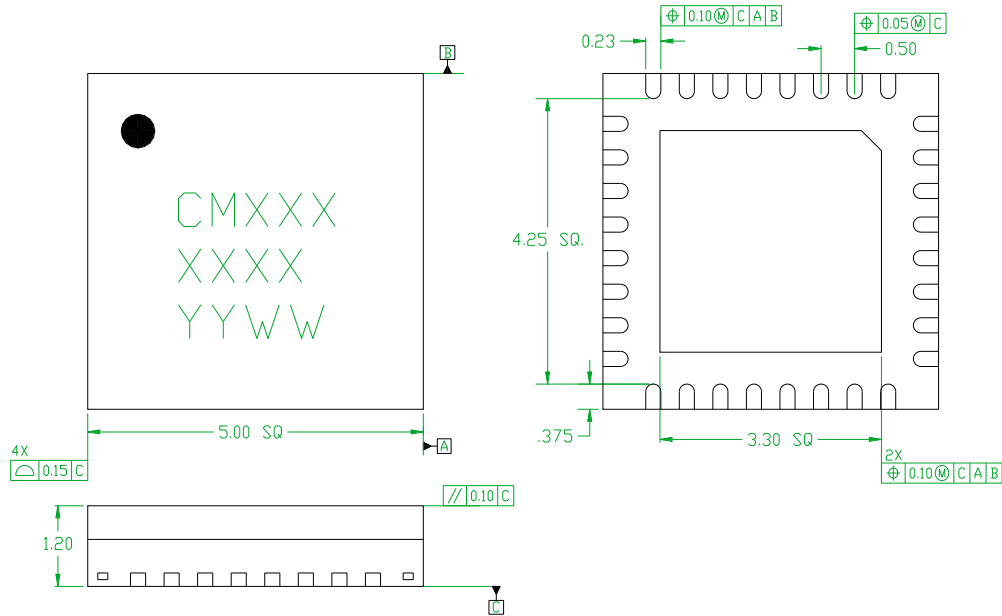

Notes:

1. All dimensions shown in mm.
2. Material: Copper alloy leadframe
3. Lead finish: NiPdAu
4. Marking
 - 4.1. Line 1: Part number
 - 4.1.1. Example: CMD244K5 shall be marked as CM244
 - 4.2. Line 2: Lot number
 - 4.3. Line 3: Date code - Last 2 digits of the year of manufacture followed by a 2-digit week code
5. Alternate pin #1 identifier is a single square pad
6. Alternate die paddle may have chamfered corners

Recommended PCB Land Pattern

Qorvo recommends that the user develop the land pattern that will provide the best design for proper solder reflow and device attach for their specific application. Please review Qorvo Application Note AN 105 for a recommended land pattern approach.

Recommended Solder Reflow Profile

Qorvo recommends screen printing with belt furnace reflow to ensure proper solder reflow and device attach. Please review Qorvo Application Note AN 102 for a recommended solder reflow profile.

Pin Description

Pin Diagram

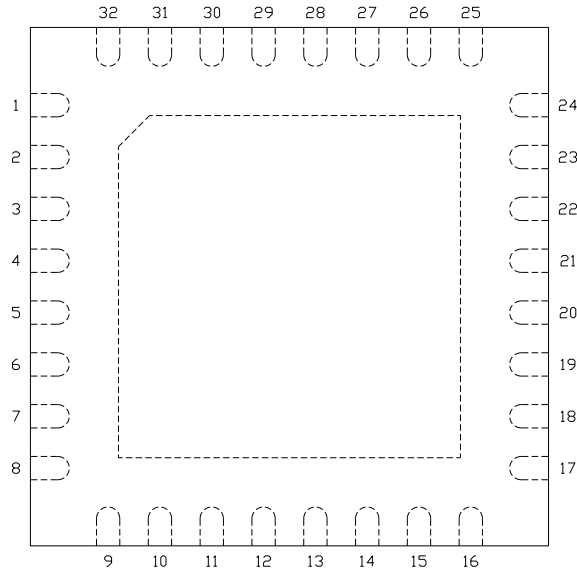

Functional Description

Pin	Function	Description	Schematic
1, 3, 4, 6 - 12, 14, 17 - 20, 22 - 28, 31, 32	N/C	No connection required These pins may be connected to RF / DC ground	
2	V _{gg2}	Optional supply voltage for gain control Decoupling and bypass caps required Pad must be left open if unused	
5	RF in	50 ohm matched input	
15, 16	ACG4, 3	Low frequency termination Attach bypass capacitor per application circuit	
13	V _{gg}	Power supply voltage Decoupling and bypass caps required	
21	RF out & V _{dd}	Power supply voltage and 50 ohm matched output	
29, 30	ACG2, 1	Low frequency termination Attach bypass capacitor per application circuit	
Die paddle	Ground	Connect to RF / DC ground	

Applications Information

Application Circuit

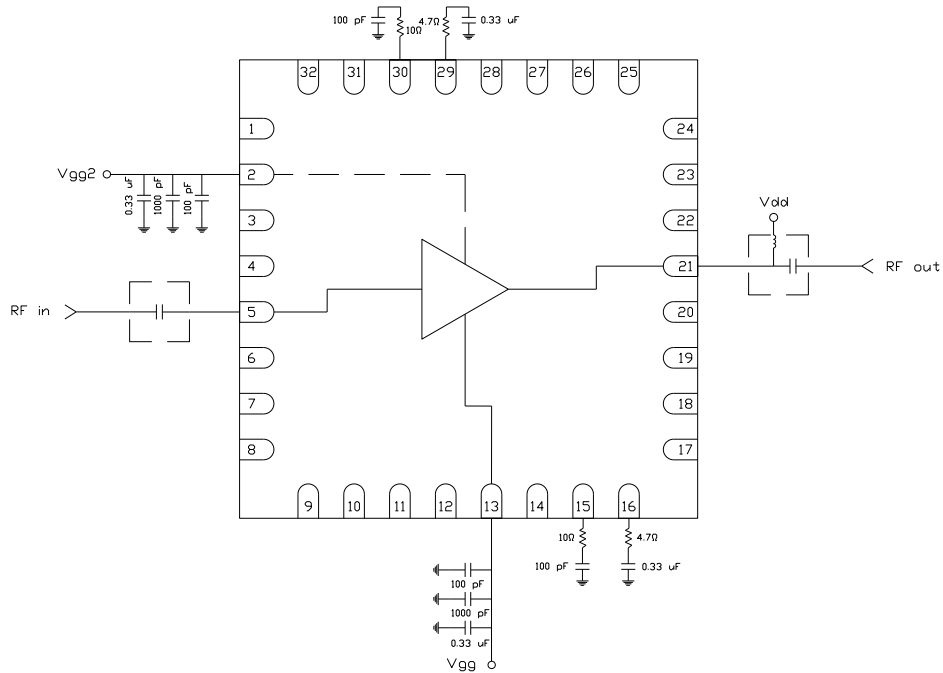

Biasing and Operation

The CMD244K5 is biased with a positive drain supply and negative gate supply. Performance is optimized when the drain voltage is set to +8.0 V. The recommended gate voltage is -1.0 V.

Turn ON procedure:

1. Apply gate voltage V_{gg} and set to -1 V
2. Apply drain voltage V_{dd} and set to +8 V

Turn OFF procedure:

1. Turn off drain voltage V_{dd}
2. Turn off gate voltage V_{gg}

RF power can be applied at any time.

GaAs MMIC devices are susceptible to damage from Electrostatic Discharge. Proper precautions should be observed during handling, assembly and test.

Applications Information

Evaluation Board

The circuit board shown has been developed for optimized assembly at Qorvo. A sufficient number of via holes should be used to connect the top and bottom ground planes. As surface mount processes vary, careful process development is recommended.

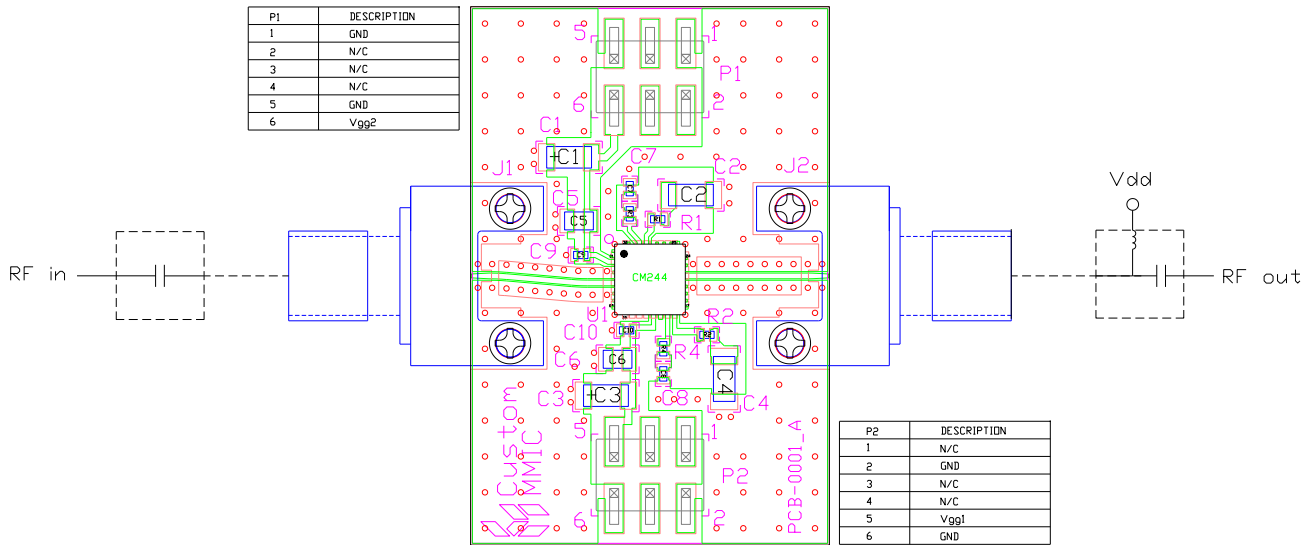

Designator	Value	Description
J1, J2		SMA End Launch Connector
P1, P2		6 Pin Header
C1 - C4	0.33 μ F	Capacitor, Tantalum
C5, C6	1000 pF	Capacitor, 0603
C7 - C10	100 pF	Capacitor, 0402
R1, R2	4.7 Ω	Resistor, 0402
R3, R4	10 Ω	Resistor, 0402
U1		CMD244K5 Driver Amplifier
PCB		100664 Evaluation PCB

Handling Precautions

Parameter	Rating	Standard
ESD – Human Body Model (HBM)	Class 1A	ESDA / JEDEC JS-001-2012
MSL – Moisture Sensitivity Level	Level 3	JEDEC standard IPC/JEDEC J-STD-020



Caution!
 ESD-Sensitive Device

RoHS Compliance

This part is compliant with 2011/65/EU RoHS directive (Restrictions on the Use of Certain Hazardous Substances in Electrical and Electronic Equipment) as amended by Directive 2015/863/EU.

This product also has the following attributes:

- Lead Free
- Antimony Free
- TBBP-A (C₁₅H₁₂Br₄O₂) Free
- SVHC Free
- PFOS Free

Contact Information

For the latest specifications, additional product information, worldwide sales and distribution locations:

Web: www.qorvo.com

Tel: 1-844-890-8163

Email: customer.support@qorvo.com

Important Notice

The information contained in this Data Sheet and any associated documents (“Data Sheet Information”) is believed to be reliable; however, Qorvo makes no warranties regarding the Data Sheet Information and assumes no responsibility or liability whatsoever for the use of said information. All Data Sheet Information is subject to change without notice. Customers should obtain and verify the latest relevant Data Sheet Information before placing orders for Qorvo® products. Data Sheet Information or the use thereof does not grant, explicitly, implicitly or otherwise any rights or licenses to any third party with respect to patents or any other intellectual property whether with regard to such Data Sheet Information itself or anything described by such information.

DATA SHEET INFORMATION DOES NOT CONSTITUTE A WARRANTY WITH RESPECT TO THE PRODUCTS DESCRIBED HEREIN, AND QORVO HEREBY DISCLAIMS ANY AND ALL WARRANTIES WITH RESPECT TO SUCH PRODUCTS WHETHER EXPRESS OR IMPLIED BY LAW, COURSE OF DEALING, COURSE OF PERFORMANCE, USAGE OF TRADE OR OTHERWISE, INCLUDING THE IMPLIED WARRANTIES OF MERCHANTABILITY AND FITNESS FOR A PARTICULAR PURPOSE. Without limiting the generality of the foregoing, Qorvo® products are not warranted or authorized for use as critical components in medical, life-saving, or life-sustaining applications, or other applications where a failure would reasonably be expected to cause severe personal injury or death. Applications described in the Data Sheet Information are for illustrative purposes only. Customers are responsible for validating that a particular product described in the Data Sheet Information is suitable for use in a particular application.

© 2022 Qorvo US, Inc. All rights reserved. This document is subject to copyright laws in various jurisdictions worldwide and may not be reproduced or distributed, in whole or in part, without the express written consent of Qorvo US, Inc. | QORVO® is a registered trademark of Qorvo US, Inc.

Looking for pricing, stock, or lifecycle information?

Click below to explore more details on WIN SOURCE:

 [View CMD244K5 on WIN SOURCE](#)

 [Qorvo US Inc. Information](#)

Optimize Your Supply Chain with WIN SOURCE Solutions

-  Global Sourcing Solution
-  Obsolete Management
-  Cost Control Management
-  Shortage Management
-  Alternative Solution
-  Excess Inventory Management