



**THE DATASHEET OF  
TGA2704-SM**



## Product Overview

Qorvo's TGA2704-SM is a high power amplifier package fabricated on Qorvo's production 0.25um pHEMT GaAs process. The TGA2704-SM operates from 9–11 GHz, provides 7 W of saturated output power with 21 dB of small signal gain and 40% power-added efficiency.

The TGA2704-SM features a ceramic QFN de-signed for surface mount to a printed circuit board.

Fully matched to 50 Ohms and with integrated DC blocking capacitors on both I/O ports, the TGA2704-SM is ideally suited to support both commercial and defense related applications.

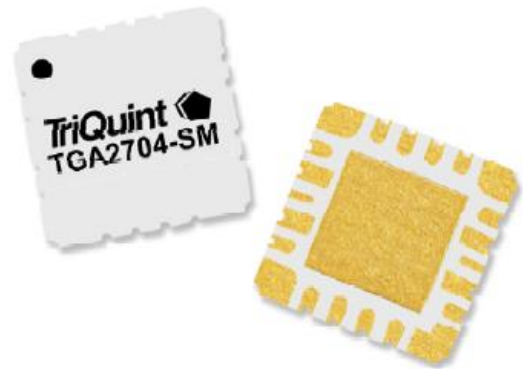

QFN 7 x 7 x 1.27 mm Air Cavity Laminate Package

## Functional Block Diagram

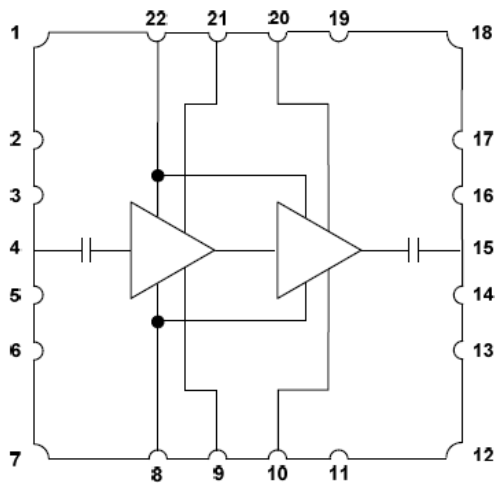

## Key Features

- Frequency Range: 9 – 11 GHz
- $P_{SAT}$  ( $P_{IN}=22$  dBm): 38.5 dBm
- PAE ( $P_{IN}=22$  dBm): 40 %
- Small Signal Gain: 21 dB
- Bias:  $V_{D1} = 9$  V,  $I_{D1} = 1.05$  A,  $V_G = -0.7$ V typical
- Package Dimensions: 7.0 x 7.0 x 1.27 mm

*Performance is typical across frequency. Please reference electrical specification table and data plots for more details.*

## Applications

- Point-to-Point Radio
- Satellite Communications
- Radar, Traffic Control
- Weather Monitoring
- Port Security

## Ordering Information

Part No.	Description
TGA2704-SM	9 – 11 GHz 7 W GaAs PA

## Absolute Maximum Ratings

Parameter	Min Values	Max Values	Units
Drain Voltage ( $V_D$ )	-	10	V
Gate Voltage Range ( $V_G$ )	-1.2	+0.5	V
Drain Current ( $I_D$ )	-	3.85	A
Gate Current ( $I_G$ )	-14	126	mA
RF Input Power, CW, 50 $\Omega$ , T=25 °C	-	23	dBm
Channel Temperature ( $T_{CH}$ )	-	200	°C
Storage Temperature	-55	150	°C
Mounting Temperature (30 seconds)	-	260	°C

Exceeding any one or a combination of the Absolute Maximum Rating conditions may cause permanent damage to the device. Extended application of Absolute Maximum Rating conditions to the device may reduce device reliability.

## Recommended Operating Conditions

Parameter	Min	Typ	Max	Units
Drain Voltage ( $V_D$ )		9		V
Drain Current, Quiescent ( $I_{DQ}$ )		1.05		A
Drain Current, RF ( $I_{D\_Drive}$ )		See plots		mA
Gate Voltage Typ. Range ( $V_G$ )	-0.9	-0.5	-0.3	V
Gate Current, RF ( $I_{G\_Drive}$ )		1.5		mA
Operating Temp. Range	-40	+25	+85	°C

Electrical specifications are measured at specified test conditions. Specifications are not guaranteed over all recommended operating conditions.

## Electrical Specifications

Parameter	Conditions <sup>(1)</sup> <sup>(2)</sup>	Min	Typ.	Max	Units
Operational Frequency Range	Unless Otherwise	9		11	GHz
Output Power at Saturation, $P_{SAT}$	$P_{IN} = +22$ dBm		38.5		dBm
Output Power at 1dB compression, $P_{1dB}$	$P_{IN} = +16$ to +17 dBm range		37.5		dBm
Power Added Efficiency, PAE	$P_{IN} = +22$ dBm		40		%
Small Signal Gain, $S_{21}$			21		dB
Input Return Loss, IRL			10		dB
Output Return Loss, ORL			13		dB
$P_{SAT}$ Temperature Coefficient	$T_{diff} = (85 - (-40))$ °C, $P_{in} = +22$ dBm		-0.011		dBm/°C

Notes:

1. Test conditions unless otherwise noted: CW,  $V_D = 9V$ ,  $I_D = 1.05$  A, adjusting  $V_G$  (typical -0.7V),  $T_{BASE} = +25$  °C,  $Z_0 = 50$   $\Omega$
2.  $T_{BASE}$  is back side of package

Performance Plots

Test conditions unless otherwise noted: CW,  $V_D/I_D = 7V/1.4A$  vs.  $9V/1.05A$ , adjusting  $V_G$  (typical  $-0.7V$ ),  $P_{IN} = +22dBm$ ,  $T_{BASE} = +25^\circ C$ ,  $Z_0 = 50 \Omega$

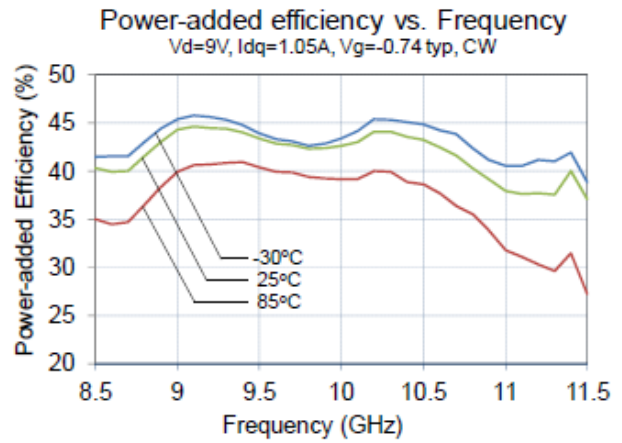
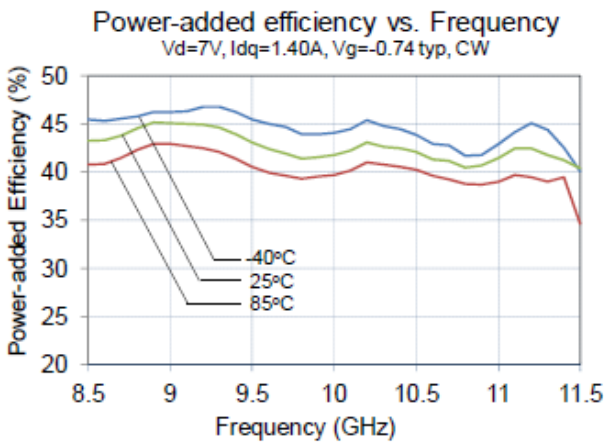
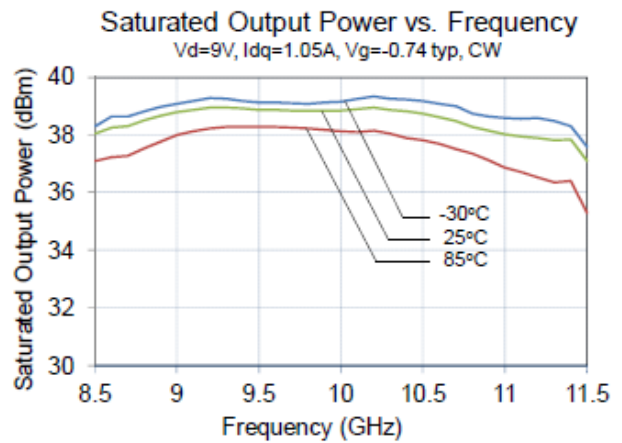
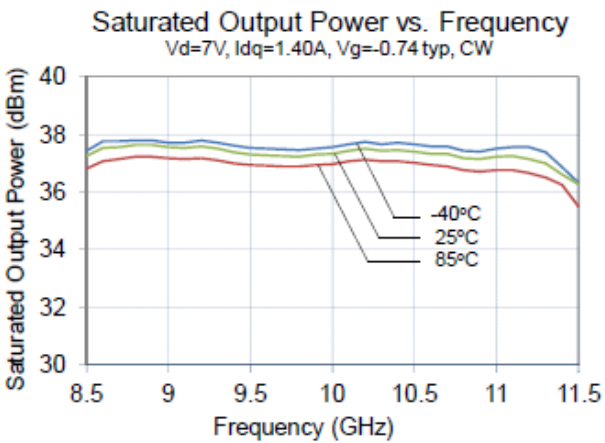
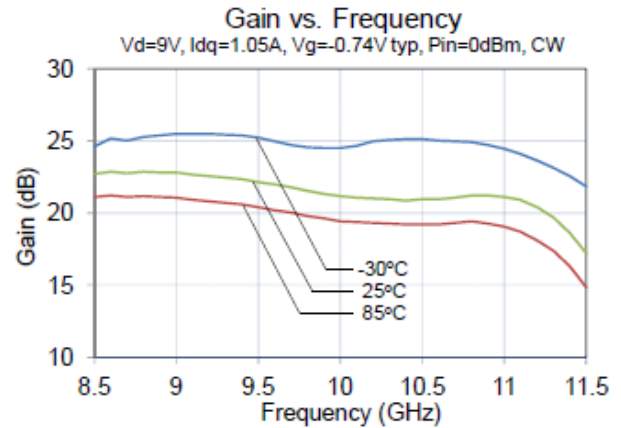
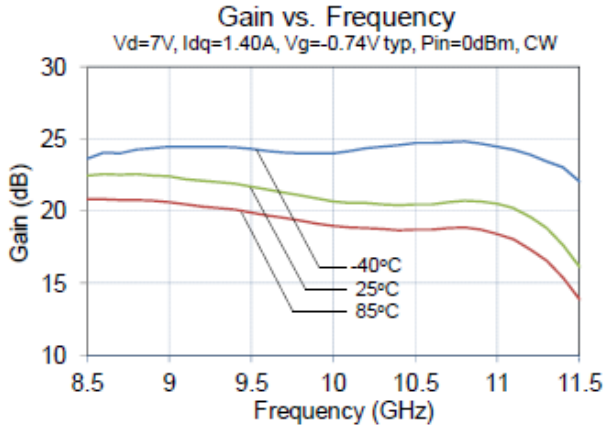

Performance Plots

Test conditions unless otherwise noted: CW,  $V_D/I_D = 7V/1.4A$  vs.  $9V/1.05A$ , adjusting  $V_G$  (typical  $-0.7V$ ),  $P_{IN} = +22dBm$ ,  $T_{BASE} = +25^\circ C$ ,  $Z_0 = 50 \Omega$

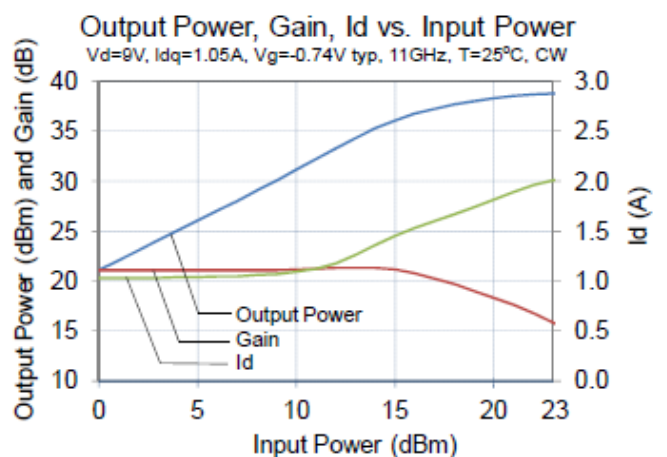
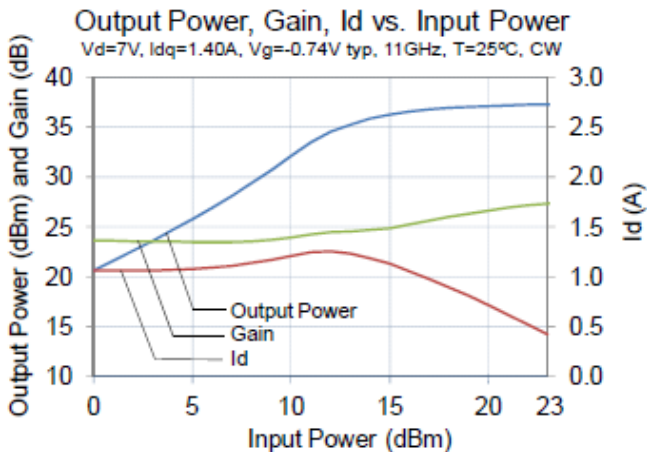
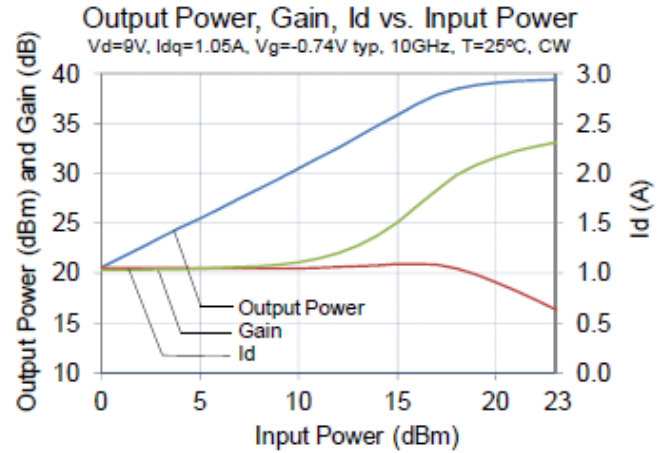
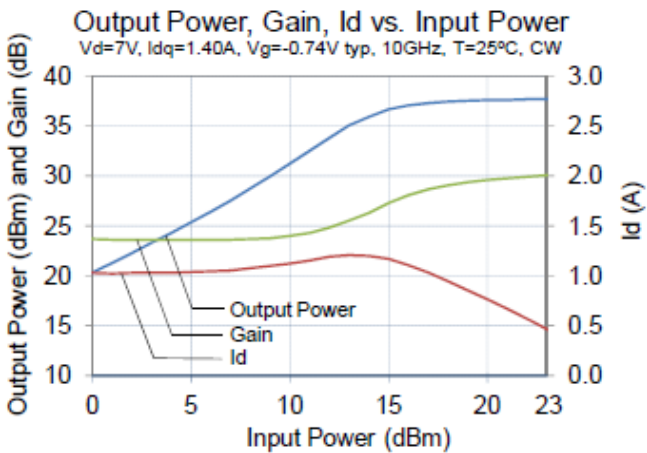
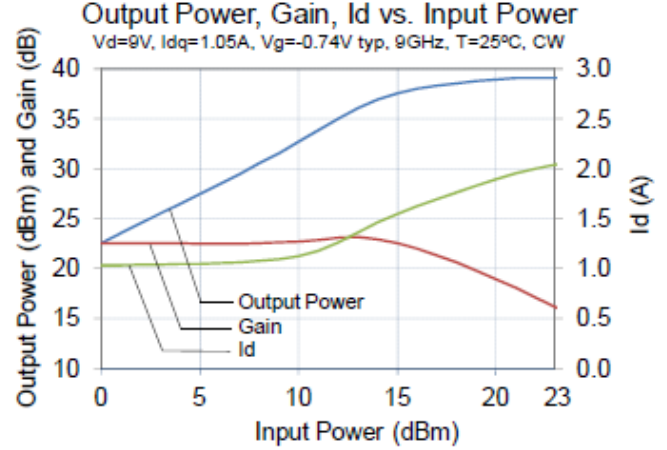
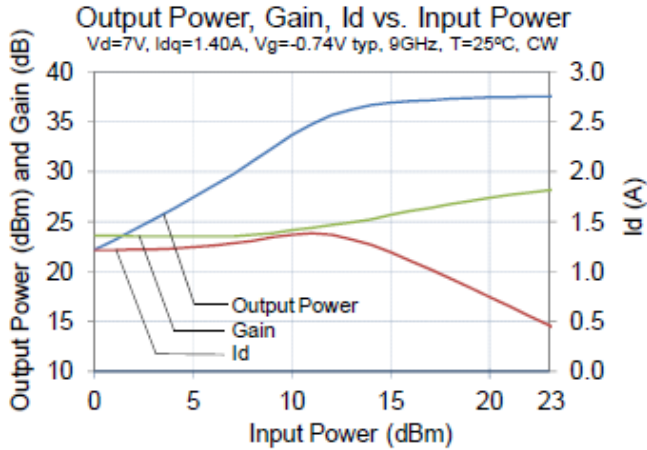

Performance Plots

Test conditions unless otherwise noted: CW,  $V_D/I_D = 7V/1.4A$  vs.  $9V/1.05A$ , adjusting  $V_G$  (typical  $-0.7V$ ),  $P_{IN} = +22dBm$ ,  $T_{BASE} = +25^\circ C$ ,  $Z_0 = 50 \Omega$

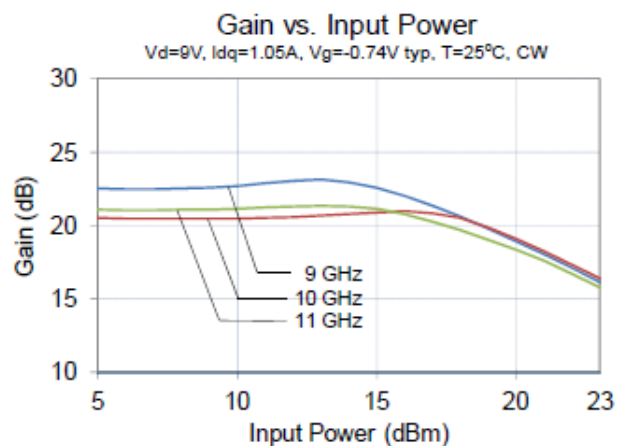
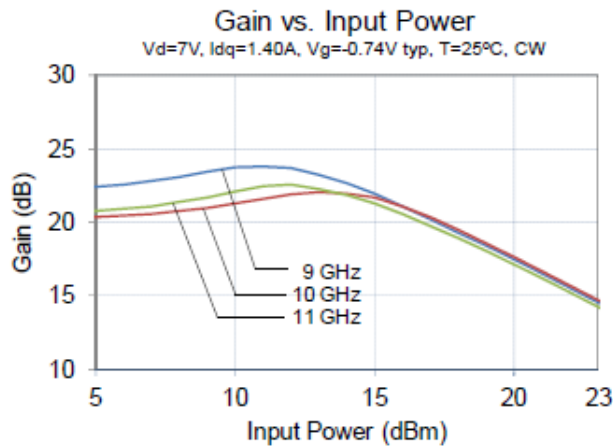
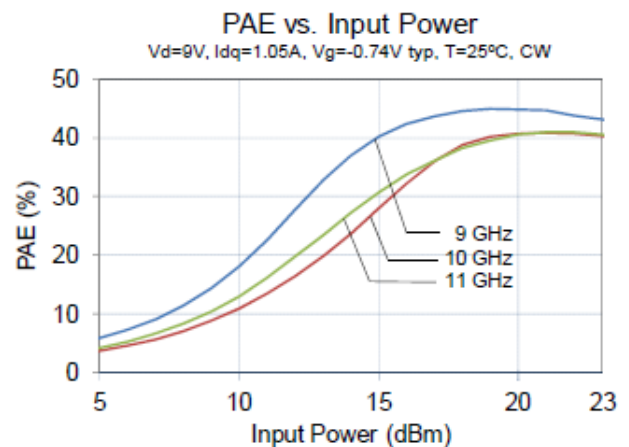
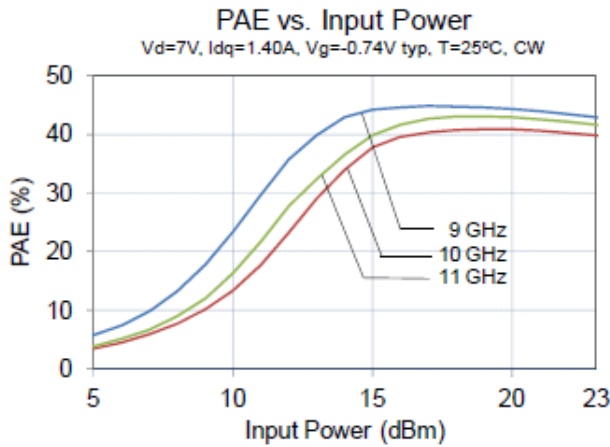
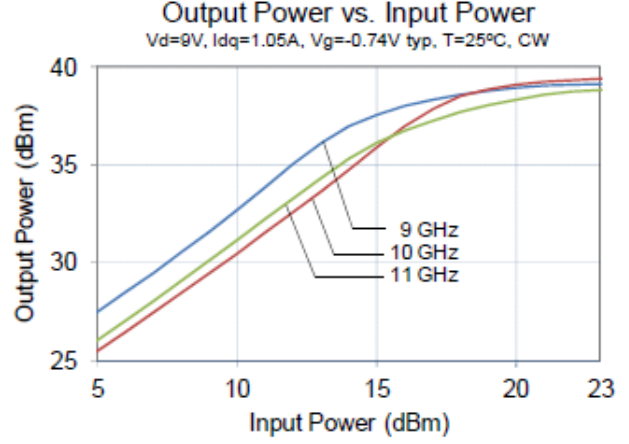
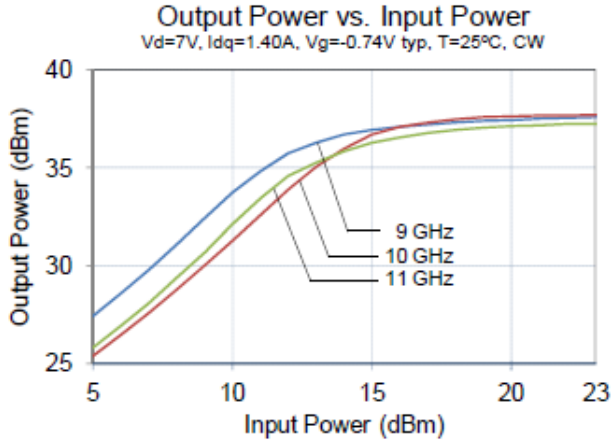

Performance Plots

Test conditions unless otherwise noted: CW,  $V_D/I_D = 7V/1.4A$  vs.  $9V/1.05A$ , adjusting  $V_G$  (typical  $-0.7V$ ),  $P_{IN} = +22dBm$ ,  $T_{BASE} = +25^\circ C$ ,  $Z_0 = 50 \Omega$

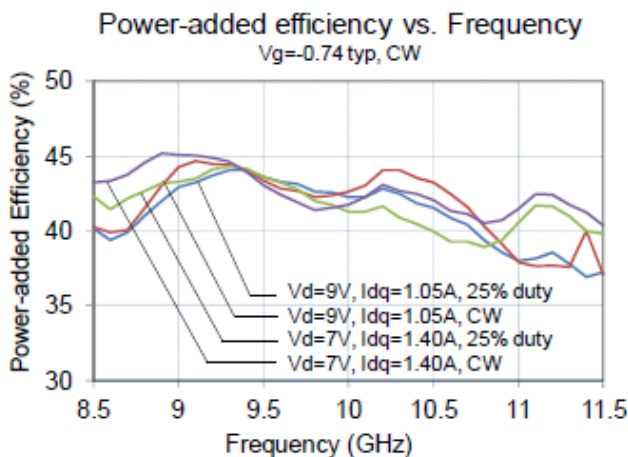
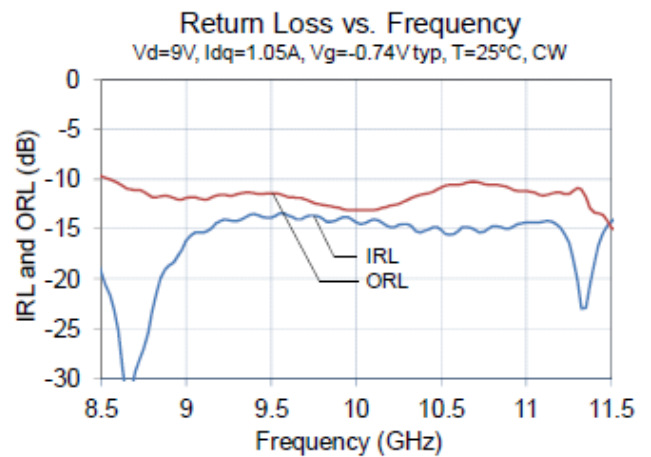
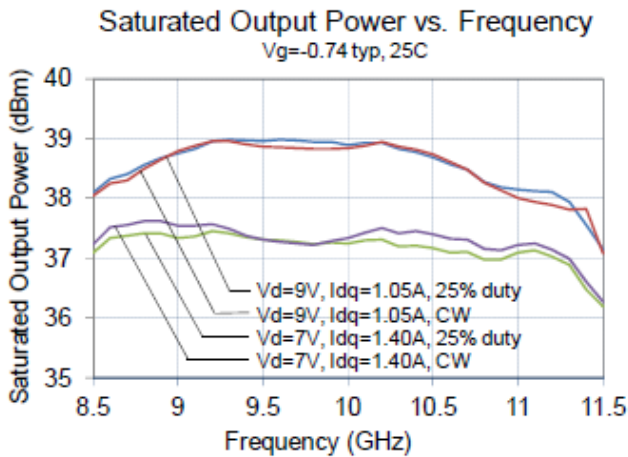
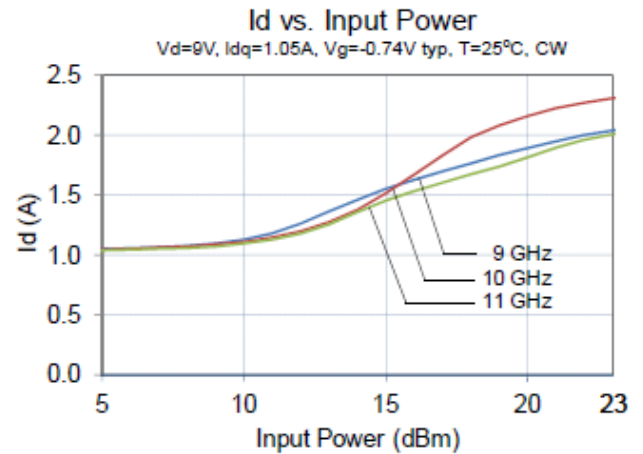
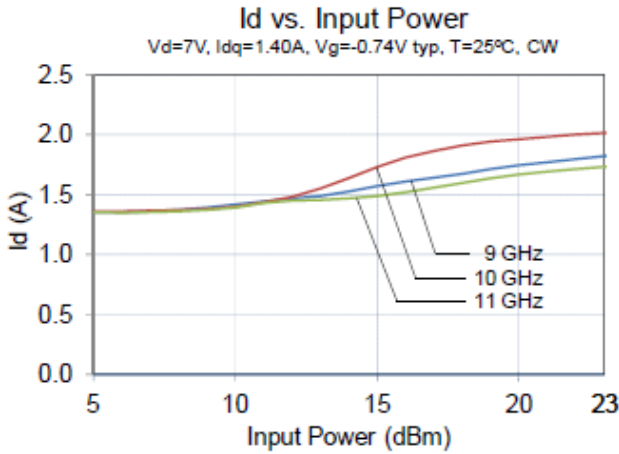

## Thermal and Reliability Information

Parameter	Test Conditions <sup>1/</sup>	Value	Units
Thermal Resistance, $\theta_{JC}$	$T_{BASE} = 85\text{ }^{\circ}\text{C}$ , CW, $V_D = 7\text{ V}$ , $I_{DQ} = 1.4\text{ A}$ , no $P_{IN}$ , $P_{DISS} = 9.8\text{ W}$	7.8	$^{\circ}\text{C/W}$
Channel Temperature, $T_{CH}$		161	$^{\circ}\text{C}$
Median Lifetime, $T_M$		4.1E+5	Hrs
Thermal Resistance, $\theta_{JC}$	$T_{BASE} = 85\text{ }^{\circ}\text{C}$ , CW, $V_D = 7\text{ V}$ , $I_{DQ} = 1.4\text{ A}$ , $I_{D\_Drive} = 1.93\text{ A}$ , $P_{OUT} = 37.3\text{ dBm}$ , $P_{DISS} = 8.1\text{ W}$	6.4	$^{\circ}\text{C/W}$
Channel Temperature, $T_{CH}$		137	$^{\circ}\text{C}$
Median Lifetime, $T_M$		3.1E+6	Hrs
Thermal Resistance, $\theta_{JC}$	$T_{BASE} = 85\text{ }^{\circ}\text{C}$ , CW, $V_D = 9\text{ V}$ , $I_{DQ} = 1.05\text{ A}$ , no $P_{IN}$ , $P_{DISS} = 9.5\text{ W}$	7.5	$^{\circ}\text{C/W}$
Channel Temperature, $T_{CH}$		156	$^{\circ}\text{C}$
Median Lifetime, $T_M$		6.1E+5	Hrs
Thermal Resistance, $\theta_{JC}$	$T_{BASE} = 85\text{ }^{\circ}\text{C}$ , CW, $V_D = 9\text{ V}$ , $I_{DQ} = 1.05\text{ A}$ , $I_{D\_Drive} = 2.11\text{ A}$ , $P_{OUT} = 38.9\text{ dBm}$ , $P_{DISS} = 11.2\text{ W}$	6.3	$^{\circ}\text{C/W}$
Channel Temperature, $T_{CH}$		156	$^{\circ}\text{C}$
Median Lifetime, $T_M$		6.1E+5	Hrs

Notes:

1. Thermal resistance determined to the back of package  $T_{BASE}$

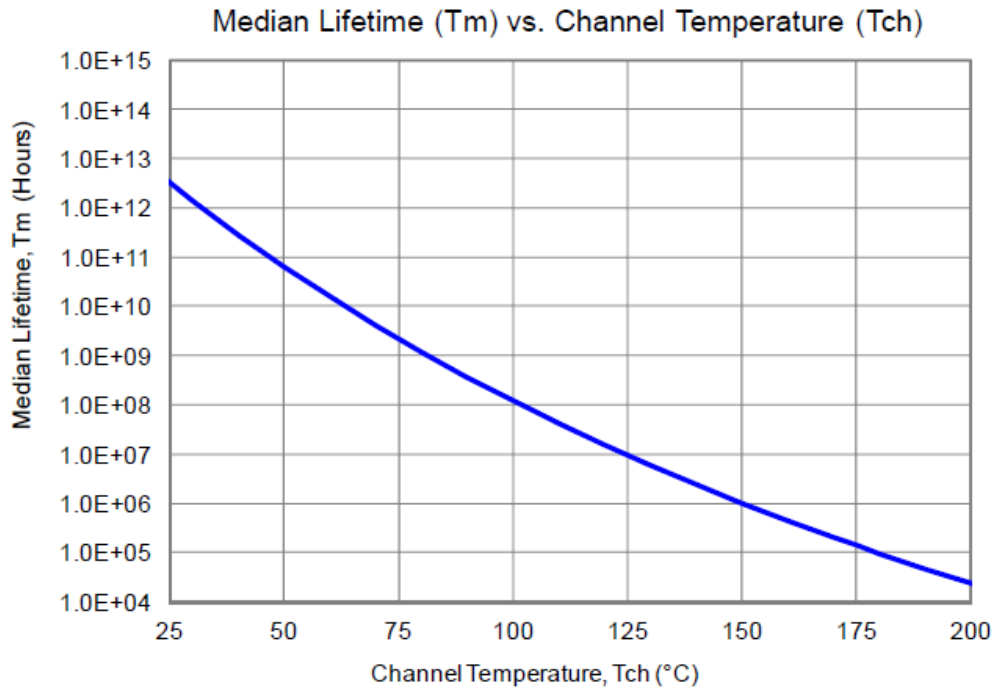

Recommended Application Circuit

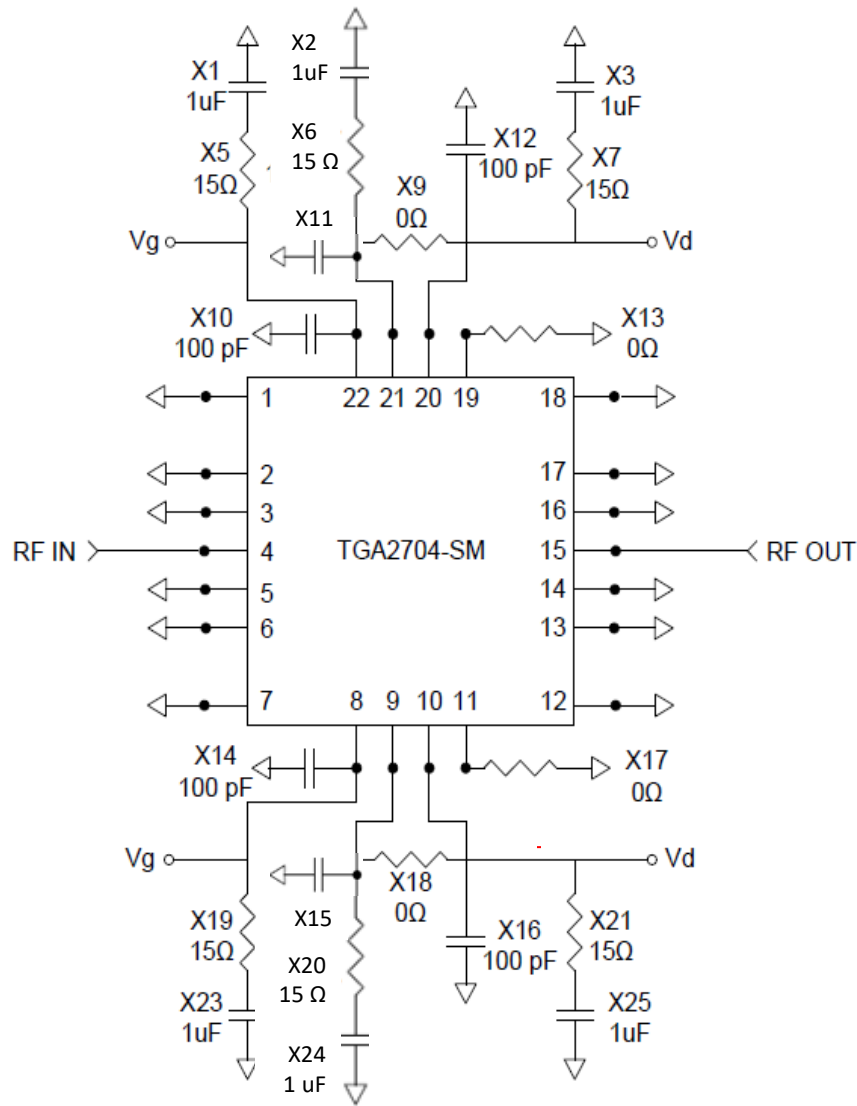

Notes:

1. Tied all V<sub>D</sub>'s together; tied all V<sub>G</sub>'s together

Bias Up Procedure

1. Set I<sub>D</sub> limit to 3.2 A, I<sub>G</sub> limit to 10 mA
2. Apply -1.1 V to V<sub>G</sub>
3. Apply +9V to V<sub>D</sub>; ensure I<sub>DQ</sub> is approx. 0 mA
4. Adjust V<sub>G</sub> until I<sub>DQ</sub> = 1.05 A (V<sub>G</sub> ~ -2.7 V +/- Typ.)
5. Turn on RF supply

Bias Down Procedure

1. Turn off RF supply
2. Reduce V<sub>G</sub> to -1.1 V; ensure I<sub>DQ</sub> is approx. 0 mA
3. Set V<sub>D</sub> to 0 V
4. Turn off V<sub>D</sub> supply
5. Turn off V<sub>G</sub> supply

Pin Description



Pad No.	Label	Description
1 – 3, 5 – 7, 12 – 14, 16 – 18	GND	Ground. Must be grounded on PCB
11, 19	GND	Ground. Recommended to ground on PCB
4	RF <sub>IN</sub>	RF input, matched to 50Ω, DC blocked
8	V <sub>G</sub>	Gate voltage. External bypassing required; refer to page 8 for recommendation
9	V <sub>D1</sub>	Drain 1 voltage. External bypassing required; refer to page 8 for recommendation
10	V <sub>D2</sub>	Drain 2 voltage. External bypassing required; refer to page 8 for recommendation
15	RF <sub>OUT</sub>	RF output, matched to 50Ω, DC blocked
20	V <sub>D2</sub>	Drain 2 voltage. External bypassing required; refer to page 8 for recommendation
21	V <sub>D1</sub>	Drain 1 voltage. External bypassing required; refer to page 8 for recommendation
22	V <sub>G</sub>	Gate voltage. External bypassing required; refer to page 8 for recommendation
	GND	Backside paddle. Multiple conductive filled vias should be employed to minimize inductance and thermal resistance; see Mounting Configuration on page 12 for suggested footprint.

Mechanical Dimensions and Marking

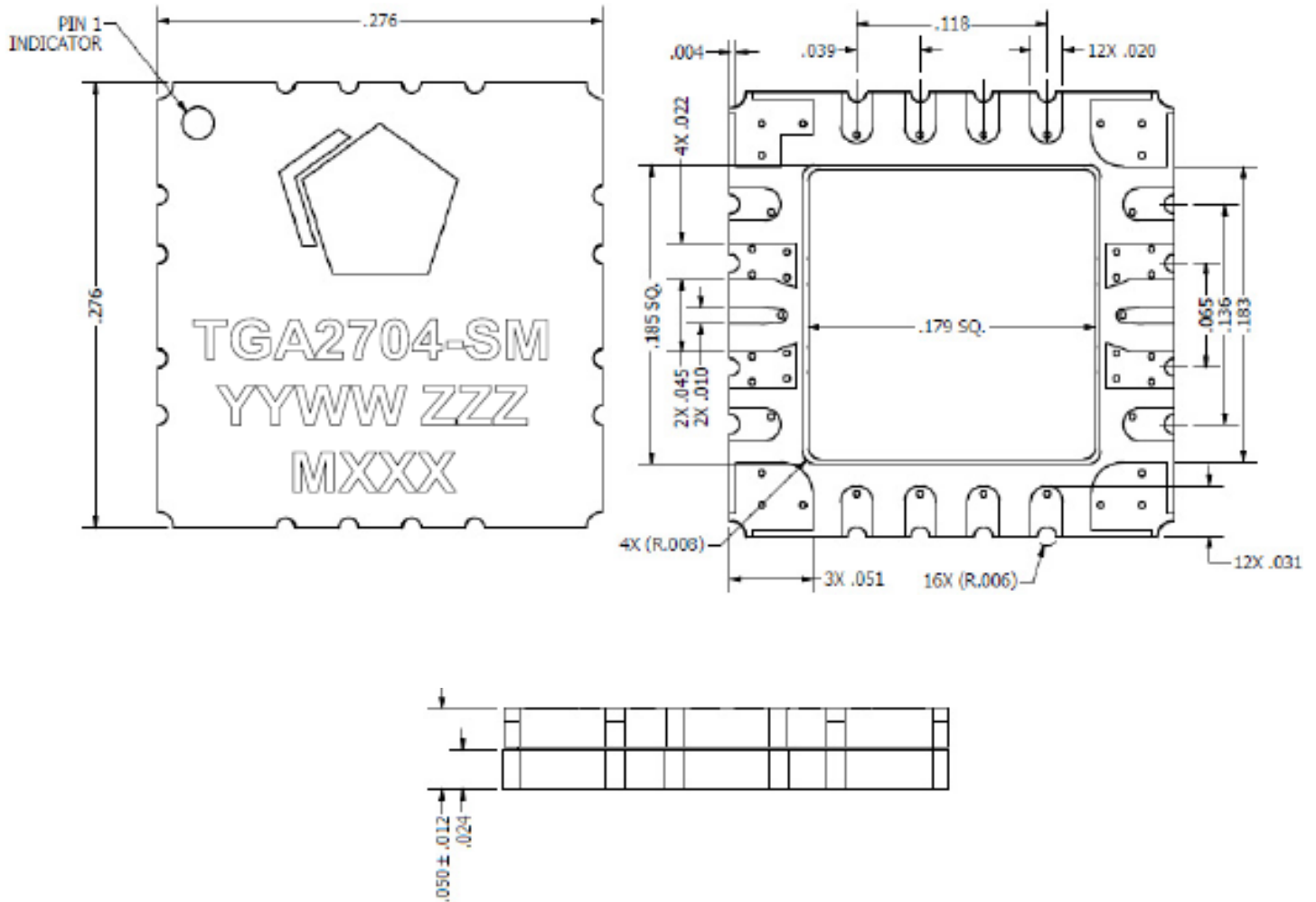

All dimensions in inches and are +/- 0.006 in unless otherwise noted.

Marking:

- YYWW assembly lot start year YY, week WW
- ZZZ part serial number
- MXXX batch ID

PCB Mounting Pattern

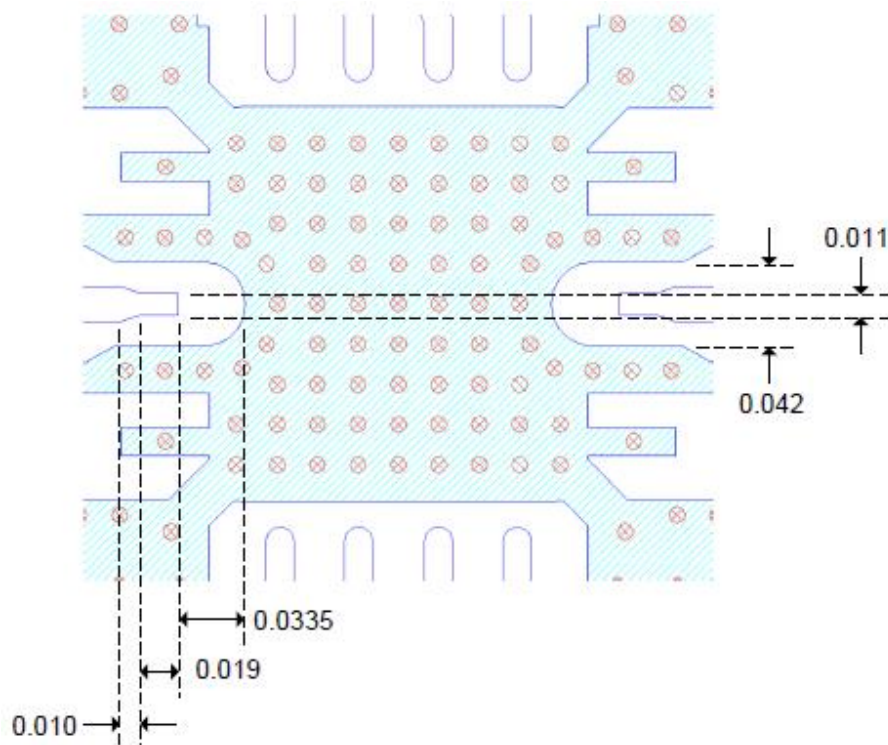

Notes:

1. All dimensions are in inches. Angles are in degrees.
2. Ground vias are critical for the proper performance of this device. Vias should use a 0.008 in diameter drill
3. For best thermal performance, vias under the ground paddle should be copper filled.
4. The pad pattern shown has been developed and tested for optimized assembly at Qorvo. The PCB land pattern has been developed to accommodate lead and package tolerances. Since surface mount processes vary from company to company, careful process development is recommended

**Assembly Notes**

Compatible with lead-free soldering processes with 260°C peak reflow temperature.

This package is air-cavity and non-hermetic, and therefore cannot be subjected to aqueous washing. The use of no-clean solder to avoid washing after soldering is highly recommended.

Contact plating: Ni-Au

Solder rework not recommended

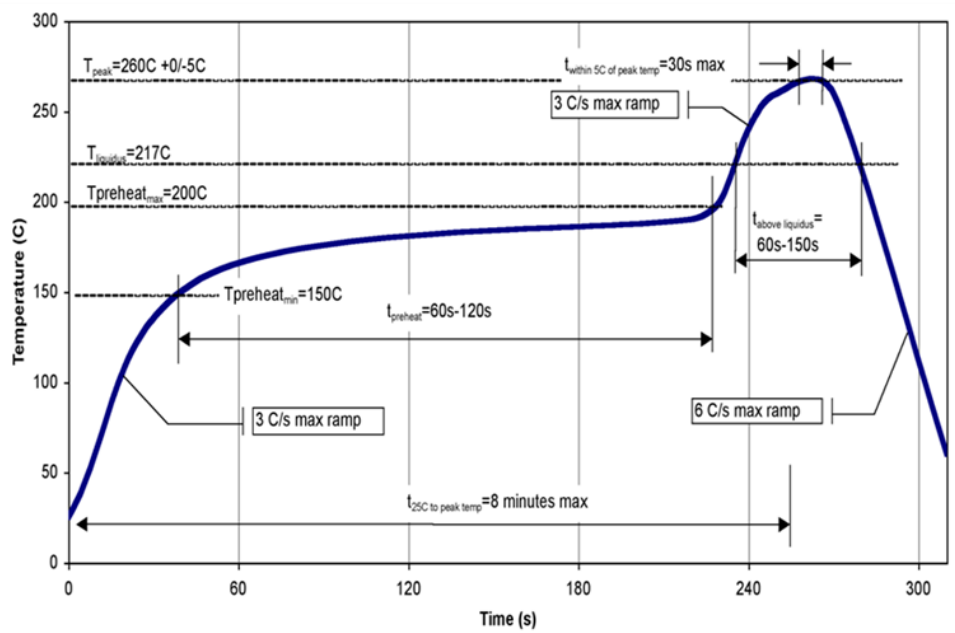

Recommended Soldering Temperature Profile

## Handling Precautions

Parameter	Rating	Standard
ESD – Human Body Model (HBM)	1A	ANSI/ESD/JEDEC JS-001
ESD – Charged Device Model (CDM)	C3	ANSI/ESD/JEDEC JS-002
MSL – Moisture Sensitivity Level	3	IPC/JEDEC J-STD-020



Caution!  
ESD-Sensitive Device

## RoHS Compliance

This product is compliant with the 2011/65/EU RoHS directive (Restrictions on the Use of Certain Hazardous Substances in Electrical and Electronic Equipment), as amended by Directive 2015/863/EU.

This product also has the following attributes:

- Lead Free
- Halogen Free (Chlorine, Bromine)
- Antimony Free
- TBBP-A (C<sub>15</sub>H<sub>12</sub>Br<sub>4</sub>O<sub>2</sub>) Free
- SVHC Free

## Contact Information

For the latest specifications, additional product information, worldwide sales and distribution locations:

**Web:** [www.qorvo.com](http://www.qorvo.com)

**Tel:** +1-844-890-8163

**Email:** [customer.support@qorvo.com](mailto:customer.support@qorvo.com)

## Important Notices

The information contained in this Data Sheet and any associated documents (“Data Sheet Information”) is believed to be reliable; however, Qorvo makes no warranties regarding the Data Sheet Information and assumes no responsibility or liability whatsoever for the use of or reliance on said information. All Data Sheet Information is subject to change without notice. Customers should obtain and verify the latest relevant Data Sheet Information before placing orders for Qorvo® products. Information concerning Qorvo’s product life cycles is available at <https://www.qorvo.com/support/product-lifecycle-information>. Data Sheet Information or the use thereof does not grant, explicitly, implicitly or otherwise any rights or licenses with respect to patents or any other intellectual property whether with regard to such Data Sheet Information itself or anything described by such information.

Qorvo grants you permission to use this Data Sheet and any associated resources only to develop an application that uses the Qorvo products described in the Data Sheet and any associated resources. Other reproduction and display of this Data Sheet and any associated resources is prohibited.

Qorvo’s products are provided subject to Qorvo’s [Terms of Sale](#) or provided in conjunction with such Qorvo products. Qorvo objects to and rejects any additional or different terms customer may have proposed regarding the purchase of Qorvo products.

DATA SHEET INFORMATION DOES NOT CONSTITUTE A WARRANTY WITH RESPECT TO THE PRODUCTS DESCRIBED HEREIN, AND QORVO HEREBY DISCLAIMS ANY AND ALL WARRANTIES WITH RESPECT TO SUCH PRODUCTS WHETHER EXPRESS OR IMPLIED BY LAW, COURSE OF DEALING, COURSE OF PERFORMANCE, USAGE OF TRADE OR OTHERWISE, INCLUDING THE IMPLIED WARRANTIES OF MERCHANTABILITY AND FITNESS FOR A PARTICULAR PURPOSE. Without limiting the generality of the foregoing, Qorvo® products are not warranted or authorized for use as critical components in medical, life-saving, or life-sustaining applications, or other applications where a failure would reasonably be expected to cause severe personal injury or death. Applications described in the Data Sheet Information are for illustrative purposes only. Customers are responsible for validating that a particular product described in the Data Sheet Information is suitable for use in a particular application.

© 2025 Qorvo US, Inc. All rights reserved. This document is subject to copyright laws in various jurisdictions worldwide and may not be reproduced or distributed, in whole or in part, without the express written consent of Qorvo US, Inc.

## Looking for pricing, stock, or lifecycle information?

Click below to explore more details on WIN SOURCE:

 [View TGA2704-SM on WIN SOURCE](#)

 [Qorvo US Inc. Information](#)

## Optimize Your Supply Chain with WIN SOURCE Solutions

-  Global Sourcing Solution
-  Obsolete Management
-  Cost Control Management
-  Shortage Management
-  Alternative Solution
-  Excess Inventory Management