

PCF Chip Type, Standard

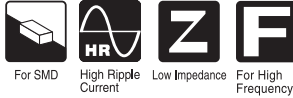

- Low ESR, High ripple current.
- Load life of 2000 hours at 105°C.
- SMD type : Lead free reflow soldering condition at 260°C peak correspondence.
- Compliant to the RoHS directive (2011/65/EU,(EU)2015/863).
- AEC-Q200 Qualified. Please contact us for details.

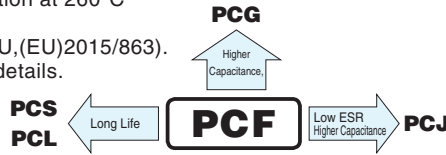

■ Specifications

Item	Performance Characteristics		
Category Temperature Range	-55 to +105°C		
Rated Voltage Range	2.5 to 25V		
Rated Capacitance Range	6.8 to 1500μF		
Capacitance Tolerance	±20% at 120Hz, 20°C		
Tangent of loss angle (tan δ)	Less than or equal to the specified value at 120Hz, 20°C		
ESR (※ 1)	Less than or equal to the specified value at 100kHz, 20°C		
Leakage Current (※ 2)	Less than or equal to the specified value. After 2 minutes' application of rated voltage at 20°C		
Temperature Characteristics (Max.Impedance Ratio)	$Z(+105^{\circ}\text{C}) / Z(+20^{\circ}\text{C}) \leq 1.25$ (100kHz) $Z(-55^{\circ}\text{C}) / Z(+20^{\circ}\text{C}) \leq 1.25$		
Endurance	The specifications listed at right shall be met when the capacitors are restored to 20°C after the rated voltage is applied for 2000 hours at 105°C	Capacitance change	Within ± 20% of the initial capacitance value (※ 3)
		tan δ	150% or less than the initial specified value
		ESR (※ 1)	150% or less than the initial specified value
		Leakage current (※ 2)	Less than or equal to the initial specified value
Damp Heat (Steady State)	The specifications listed at right shall be met when the capacitors are restored to 20°C after the rated voltage is applied for 1000 hours at 60°C, 90% RH.	Capacitance change	Within ± 20% of the initial capacitance value (※ 3)
		tan δ	150% or less than the initial specified value
		ESR (※ 1)	150% or less than the initial specified value
		Leakage current (※ 2)	Less than or equal to the initial specified value
Resistance to Soldering Heat	After soldering the capacitor under the soldering conditions prescribed here, the capacitor shall meet the specifications listed at right. Pre-heating shall be done at 150 to 200°C and for 60 to 180 sec. The duration for over +230°C temperature at capacitor surface shall not exceed 60 seconds. In case peak temperature is 250°C or less, reflow soldering shall be two times maximum. In case peak temperature is 260°C or less, reflow soldering shall be once. Measurement for solder temperature profile shall be made at the capacitor top.	Capacitance change	Within ± 10% of the initial capacitance value (※ 3)
		tan δ	130% or less than the initial specified value
		ESR (※ 1)	130% or less than the initial specified value
		Leakage current (※ 2)	Less than or equal to the initial specified value
Marking	Navy blue print on the case top		

※ 1 ESR should be measured at both of the terminal ends closest where the terminals protrude through the plastic platform.
 ※ 2 Conditioning : If any doubt arises, measure the leakage current after the voltage treatment of applying DC rated voltage continuously to the capacitor for 120 minutes at 105°C.
 ※ 3 Initial value : The value before test of examination of resistance to soldering.

■ Dimensions

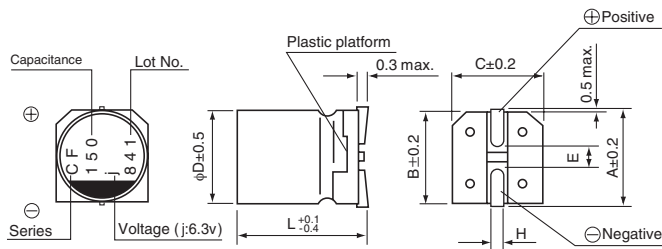

Size	φ5 × 6L	φ6.3 × 5.5L	φ6.3 × 6L	φ8 × 7L	φ8 × 12L	φ10 × 8L	φ10 × 10L	φ10 × 12.7L
φD	5.0	6.3	6.3	8.0	8.0	10.0	10.0	10.0
L	5.9	5.4	5.9	6.9	11.9	7.9	9.9	12.6
A	6.0	7.3	7.3	9.0	9.0	11.0	11.0	11.0
B	5.3	6.6	6.6	8.3	8.3	10.3	10.3	10.3
C	5.3	6.6	6.6	8.3	8.3	10.3	10.3	10.3
E	1.6	2.1	2.1	3.2	3.2	4.6	4.6	4.6
H	0.5 to 0.8	0.5 to 0.8	0.5 to 0.8	0.8 to 1.1	0.8 to 1.1	0.8 to 1.1	0.8 to 1.1	0.8 to 1.1

● Dimension table in next page.

Type numbering system (Example : 6.3V 150μF)

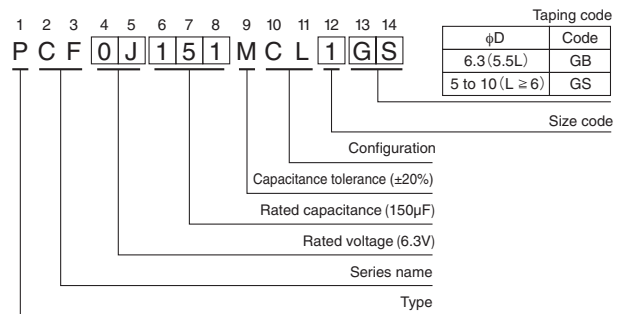

Voltage

V	2.5	4	6.3	10	16	20	25
Code	e	g	j	A	C	D	E

● Frequency coefficient of rated ripple current

Frequency	120Hz	1kHz	10kHz	100kHz or more
Coefficient	0.05	0.30	0.70	1.00

PCF

■ Dimensions

Rated Voltage (V) (code)	Surge Voltage (V)	Rated Capacitance (μF)	Case Size φD × L (mm)	tan δ	Leakage Current (μA) (at 20°C after 2 minutes)	ESR (mΩ) (20°C/100kHz)	Rated Ripple (mArms) (105°C/100kHz)	Part Number
2.5 (0E)	2.8	100	6.3 × 6	0.12	100	22	2600	PCF0E101MCL1GS
		220	■ 6.3 × 5.5	0.12	110	20	2800	PCF0E221MCL4GB
		220	6.3 × 6	0.12	110	20	2800	PCF0E221MCL1GS
		470	8 × 7	0.12	235	20	3300	PCF0E471MCL1GS
		820	10 × 8	0.12	410	17	4400	PCF0E821MCL1GS
		1500	10 × 10	0.12	750	13	4700	PCF0E152MCL1GS
4 (0G)	4.6	100	■ 6.3 × 5.5	0.12	100	22	2600	PCF0G101MCL4GB
		100	6.3 × 6	0.12	80	22	2600	PCF0G101MCL1GS
		150	■ 6.3 × 5.5	0.12	120	22	2800	PCF0G151MCL4GB
		150	▲ 5 × 6	0.12	300	30	2000	PCF0G151MCL6GS
		150	6.3 × 6	0.12	120	22	2800	PCF0G151MCL1GS
		220	8 × 7	0.12	176	21	3200	PCF0G221MCL1GS
		330	8 × 7	0.12	264	21	3400	PCF0G331MCL1GS
		470	10 × 8	0.12	376	17	4200	PCF0G471MCL1GS
		560	■ 8 × 12	0.12	448	13	4520	PCF0G561MCL4GS
		680	10 × 8	0.12	544	17	4400	PCF0G681MCL1GS
		820	10 × 10	0.12	656	13	4800	PCF0G821MCL1GS
6.3 (0J)	7.2	1200	10 × 12.7	0.12	960	10	5500	PCF0G122MCL1GS
		47	5 × 6	0.12	148	35	1600	PCF0J470MCL1GS
		82	■ 6.3 × 5.5	0.12	103	23	2600	PCF0J820MCL4GB
		82	6.3 × 6	0.12	103	23	2600	PCF0J820MCL1GS
		100	■ 6.3 × 5.5	0.12	126	23	2800	PCF0J101MCL4GB
		100	▲ 5 × 6	0.12	315	25	2200	PCF0J101MCL6GS
		100	6.3 × 6	0.12	126	23	2800	PCF0J101MCL1GS
		120	6.3 × 6	0.12	151	23	3000	PCF0J121MCL1GS
		150	8 × 7	0.12	189	22	3200	PCF0J151MCL1GS
		220	8 × 7	0.12	277	22	3400	PCF0J221MCL1GS
		330	10 × 8	0.12	416	18	4200	PCF0J331MCL1GS
		470	■ 8 × 12	0.12	592	12	5300	PCF0J471MCL4GS
		470	▲ 10 × 8	0.12	592	18	4300	PCF0J471MCL6GS
		470	10 × 10	0.12	592	16	4600	PCF0J471MCL1GS
		680	10 × 10	0.12	857	14	5000	PCF0J681MCL1GS
		680	● 10 × 12.7	0.12	857	10	5500	PCF0J681MCL9GS
		820	10 × 12.7	0.12	1033	10	5800	PCF0J821MCL1GS
10 (1A)	11.5	33	5 × 6	0.12	165	35	1500	PCF1A330MCL1GS
		47	▲ 5 × 6	0.12	235	26	2600	PCF1A470MCL6GS
		47	6.3 × 6	0.12	94	26	2600	PCF1A470MCL1GS
		56	■ 6.3 × 5.5	0.12	112	25	2500	PCF1A560MCL4GB
		56	6.3 × 6	0.12	112	25	2500	PCF1A560MCL1GS
		120	8 × 7	0.12	240	23	3000	PCF1A121MCL1GS
		150	▲ 8 × 7	0.12	300	23	3200	PCF1A151MCL6GS
		150	10 × 8	0.12	300	21	3300	PCF1A151MCL1GS
		270	■ 8 × 12	0.12	540	13	4500	PCF1A271MCL4GS
		270	10 × 8	0.12	540	20	3600	PCF1A271MCL1GS
		330	■ 8 × 12	0.12	660	14	4000	PCF1A331MCL4GS
		330	10 × 8	0.12	660	20	3700	PCF1A331MCL1GS
		470	10 × 10	0.12	940	16	4600	PCF1A471MCL1GS
		470	● 10 × 12.7	0.12	940	12	5300	PCF1A471MCL9GS
		560	10 × 10	0.12	1120	15	4800	PCF1A561MCL1GS
560	● 10 × 12.7	0.12	1120	13	5230	PCF1A561MCL9GS		

PCF

■ Dimensions



Rated Voltage (V) (code)	Surge Voltage (V)	Rated Capacitance (μF)	Case Size φD × L (mm)	tan δ	Leakage Current (μA) (at 20°C after 2 minutes)	ESR (mΩ) (20°C/100kHz)	Rated Ripple (mArms) (105°C/100kHz)	Part Number
16 (1C)	18.4	22	5 × 6	0.12	176	45	1210	PCF1C220MCL1GS
		33	6.3 × 6	0.12	106	31	2400	PCF1C330MCL1GS
		39	■ 6.3 × 5.5	0.12	125	31	2400	PCF1C390MCL4GB
		39	6.3 × 6	0.12	125	31	2400	PCF1C390MCL1GS
		56	8 × 7	0.12	179	30	2900	PCF1C560MCL1GS
		82	8 × 7	0.12	262	28	3200	PCF1C820MCL1GS
		100	10 × 8	0.12	320	27	3300	PCF1C101MCL1GS
		150	10 × 8	0.12	480	25	3500	PCF1C151MCL1GS
		180	■ 8 × 12	0.12	576	16	4400	PCF1C181MCL4GS
		180	10 × 8	0.12	576	25	3600	PCF1C181MCL1GS
		220	10 × 10	0.12	704	20	3900	PCF1C221MCL1GS
220	● 10 × 12.7	0.12	704	14	5050	PCF1C221MCL9GS		
330	10 × 12.7	0.12	1056	14	5000	PCF1C331MCL1GS		
20 (1D)	23	10	5 × 6	0.12	100	120	900	PCF1D100MCL1GS
		22	■ 6.3 × 5.5	0.12	100	50	1700	PCF1D220MCL4GB
		22	6.3 × 6	0.12	88	50	1700	PCF1D220MCL1GS
		39	8 × 7	0.12	156	45	2000	PCF1D390MCL1GS
		47	8 × 7	0.12	188	45	2000	PCF1D470MCL1GS
		56	10 × 8	0.12	224	40	2400	PCF1D560MCL1GS
		68	10 × 8	0.12	272	40	2600	PCF1D680MCL1GS
		82	10 × 8	0.12	328	40	2600	PCF1D820MCL1GS
		100	8 × 12	0.12	400	22	3200	PCF1D101MCL1GS
		120	10 × 10	0.12	480	35	2800	PCF1D121MCL1GS
150	10 × 12.7	0.12	600	20	4320	PCF1D151MCL1GS		
25 (1E)	28.7	6.8	6.3 × 6	0.12	85	80	1200	PCF1E6R8MCL1GS
		10	8 × 7	0.12	125	60	1600	PCF1E100MCL1GS
		22	10 × 8	0.12	275	50	2200	PCF1E220MCL1GS
		33	8 × 12	0.12	413	30	2800	PCF1E330MCL1GS
		47	■ 8 × 12	0.12	588	30	3000	PCF1E470MCL4GS
		47	10 × 10	0.12	588	45	2400	PCF1E470MCL1GS
56	10 × 12.7	0.12	700	28	3800	PCF1E560MCL1GS		

No marked, [1] will be put at 12th digit of type numbering system.
 ■ : In this case, [4] will be put at 12th digit of type numbering system.
 ▲ : In this case, [6] will be put at 12th digit of type numbering system.
 ● : In this case, [9] will be put at 12th digit of type numbering system.







• For taping specifications, recommended land size/soldering by reflow and minimum order quantity, please refer to the Guidelines for Aluminum Electrolytic Capacitors.

Looking for pricing, stock, or lifecycle information?

Click below to explore more details on WIN SOURCE:

-  [View PCF1A331MCL4GS on WIN SOURCE](#)
-  [Nichicon Information](#)

Optimize Your Supply Chain with WIN SOURCE Solutions

-  Global Sourcing Solution
-  Obsolete Management
-  Cost Control Management
-  Shortage Management
-  Alternative Solution
-  Excess Inventory Management