



**THE DATASHEET OF  
ICS9250BF-27LFT**



# Frequency Generator and Integrated Buffers for Celeron & PII/III™

**ICS9250-27**

## Recommended Application:

810/810E and 815 type chipset.

## Output Features:

- 3 CPU (2.5V) (up to 133MHz achievable through I<sup>2</sup>C)
- 9 SDRAM (3.3V) (up to 133MHz achievable through I<sup>2</sup>C)
- 7 PCI (3.3 V) @ 33.3MHz
- 2 IOAPIC (2.5V) @ 33.3 MHz
- 3 Hublink clocks (3.3 V) @ 66.6 MHz
- 2 (3.3V) @ 48 MHz (Non spread spectrum)
- 1 REF (3.3V) @ 14.318 MHz

## Features:

- Supports spread spectrum modulation, 0 to -0.5% down spread.
- I<sup>2</sup>C support for power management
- Efficient power management scheme through PD#
- Uses external 14.138 MHz crystal
- Alternate frequency selections available through I<sup>2</sup>C control.

## Block Diagram

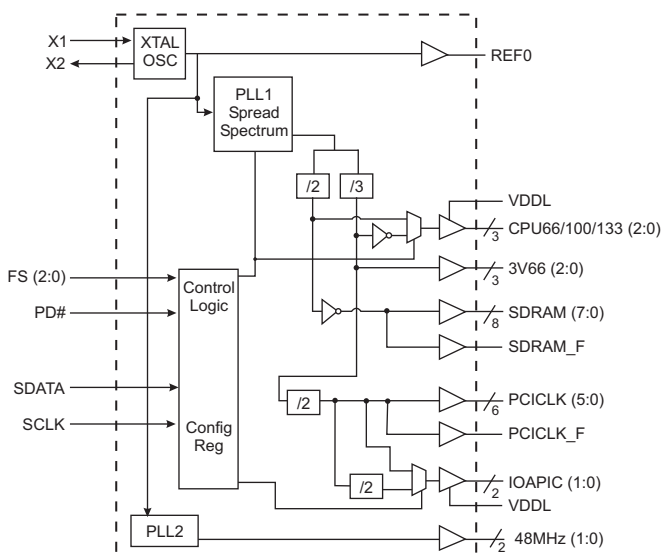

## Pin Configuration

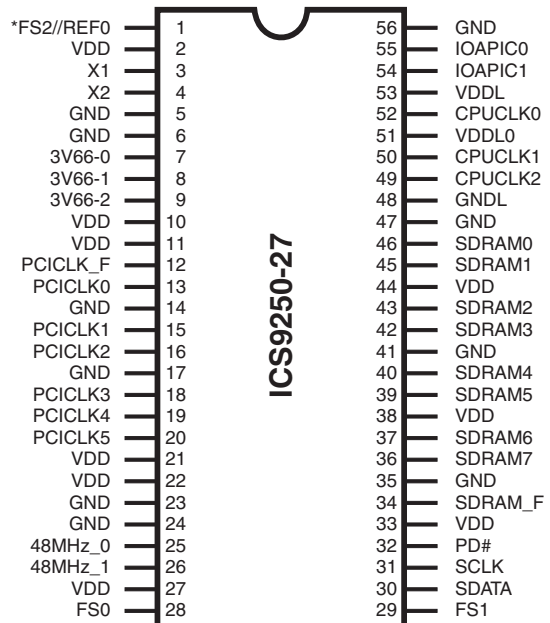

## 56-Pin 300mil SSOP

\* This input has a 50KΩ pull-down to GND.

## Functionality

FS2	FS1	FS0	Function
X	0	0	Tristate
X	0	1	Test
0	1	0	Active CPU = 66MHz SDRAM = 100MHz
0	1	1	Active CPU = 100MHz SDRAM = 100MHz
1	1	0	Active CPU = 133MHz SDRAM = 133MHz
1	1	1	Active CPU = 133MHz SDRAM = 100MHz

## Power Groups

AVDD = Pin 22 Analog power for PLL  
 AGND = Pin 23 Analog ground  
 VDD48 = Pin 27 Analog power for 48MHz PLL  
 GND = Pin 24 Analog ground for 48MHz PLL

## General Description

The **ICS9250-27** is a single chip clock solution for 810/810E and 815 type chipset. It provides all necessary clock signals for such a system.

Spread spectrum may be enabled through I<sup>2</sup>C programming. Spread spectrum typically reduces EMI by 8dB to 10 dB. This simplifies EMI qualification without resorting to board design iterations or costly shielding. The ICS9250-27 employs a proprietary closed loop design, which tightly controls the percentage of spreading over process and temperature variations.

## Pin Description

PIN NUMBER	PIN NAME	TYPE	DESCRIPTION
1	FS2	IN	Function Select pin. Determines CPU frequency, all output functionality
	REF0	OUT	3.3V, 14.318MHz reference clock output.
3	X1	IN	Crystal input, has internal load cap (33pF) and feedback resistor from X2
4	X2	OUT	Crystal output, nominally 14.318MHz. Has internal load cap (33pF)
5, 6, 14, 17, 23, 24, 35, 41, 47, 48, 56	GND	PWR	Ground pins for 3.3V supply
9, 8, 7	3V66 (2:0)	OUT	3.3V Fixed 66MHz clock outputs for HUB
2, 10, 11, 21, 22, 27, 33, 38, 44	VDD	PWR	3.3V power supply
12	PCICLK_F	OUT	Free running 3.3V PCI clock output
20, 19, 18, 16, 15, 13	PCICLK (5:0)	OUT	3.3V PCI clock outputs
25	48MHz_0	OUT	3.3V Fixed 48MHz clock outputs for USB
26	48MHz_1	OUT	3.3V fixed 48MHz clock output. Stronger output for graphics/video interface (minimum 1V/ns edge rate)
29, 28	FS (1:0)	IN	Function Select pins. Determines CPU frequency, all output functionality. Please refer to Functionality table on page 1
30	SDATA	I/O	Data pin for I <sup>2</sup> C circuitry 5V tolerant
31	SCLK	IN	Clock pin of I <sup>2</sup> C circuitry 5V tolerant
32	PD#	IN	Asynchronous active low input pin used to power down the device into a low power state. The internal clocks are disabled and the VCO and the crystal are stopped. The latency of the power down will not be greater than 3ms.
36, 37, 39, 40, 42, 43, 45, 46	SDRAM (7:0)	OUT	3.3V output running 100MHz. All SDRAM outputs can be turned off through I <sup>2</sup> C
34	SDRAM_F	OUT	3.3V free running 100MHz SDRAM, cannot be turned off through I <sup>2</sup> C
49, 50, 52	CPUCCLK (2:0)	OUT	2.5V Host bus clock output. 66MHz, 100MHz or 133MHz depending on FS pins.
51, 53	VDDL	PWR	2.5V power supply for CPU & IOAPIC
54, 55	IOAPIC (1:0)	OUT	2.5V clock outputs running at 33.3MHz.

## Power Down Waveform

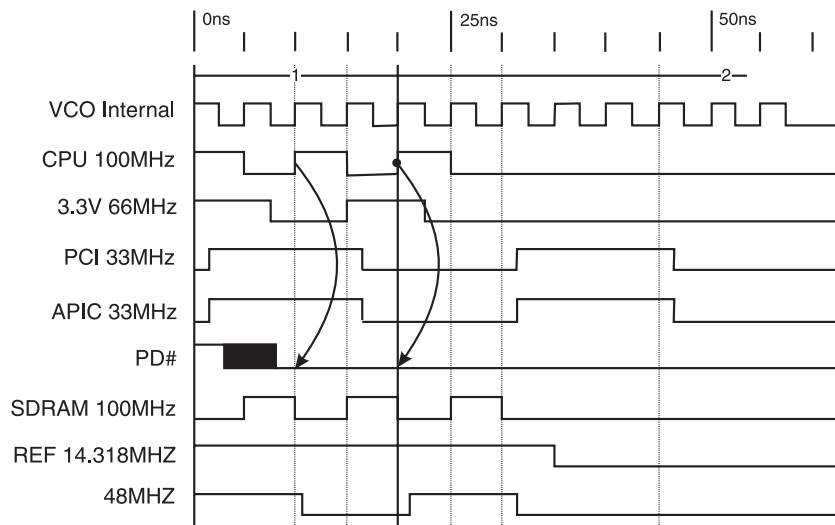

### Note

1. After PD# is sampled active (Low) for 2 consecutive rising edges of CPUCLKs, all the output clocks are driven Low on their next High to Low transition.
2. Power-up latency <3ms.
3. Waveform shown for 100MHz

## Maximum Allowed Current

815 Condition	Max 2.5V supply consumption Max discrete cap loads, Vddq2 = 2.625V All static inputs = Vddq3 or GND	Max 2.5V supply consumption Max discrete cap loads, Vddq2 = 3.465V All static inputs = Vddq3 or GND
<b>Powerdown Mode</b> (PWRDWN# = 0)	10mA	10mA
<b>Full Active 66MHz</b> FS[2:0] = 010	70mA	280mA
<b>Full Active 100MHz</b> FS[2:0] = 011	100mA	280mA
<b>Full Active 133MHz</b> FS[2:0] = 111		

## Clock Enable Configuration

PD#	CPUCLK	SDRAM	IOAPIC	66MHz	PCICLK	REF, 48MHz	Osc	VCOs
0	LOW	LOW	LOW	LOW	LOW	LOW	OFF	OFF
1	ON	ON	ON	ON	ON	ON	ON	ON

**Truth Table**

FS2	FS1	FS0	CPU	SDRAM	3V66	PCI	48MHz	REF	IOAPIC
X	0	0	Tristate	Tristate	Tristate	Tristate	Tristate	Tristate	Tristate
X	0	1	TCLK/2	TCLK/2	TCLK/3	TCLK/6	TCLK/2	TCLK	TCLK/6
0	1	0	66.6 MHz	100 MHz	66.6 MHz	33.3 MHz	48 MHz	14.318 MHz	33.3 MHz
0	1	1	100 MHz	100 MHz	66.6 MHz	33.3 MHz	48 MHz	14.318 MHz	33.3 MHz
1	1	0	133 MHz	133 MHz	66.6 MHz	33.3 MHz	48 MHz	14.318 MHz	33.3 MHz
1	1	1	133 MHz	100 MHz	66.6 MHz	33.3 MHz	48 MHz	14.318 MHz	33.3 MHz

**Byte 0: Control Register**  
(1 = enable, 0 = disable)

Bit	Pin#	Name	PWD	Description
Bit 7		Reserved ID	0	(Active/Inactive)
Bit 6		Reserved ID	0	(Active/Inactive)
Bit 5		Reserved ID	0	(Active/Inactive)
Bit 4		Reserved ID	0	(Active/Inactive)
Bit 3		SpreadSpectrum (1=On/0=Off)	1	(Active/Inactive)
Bit 2	26	48MHz 1	1	(Active/Inactive)
Bit 1	25	48MHz 0	1	(Active/Inactive)
Bit 0	49	CPUCLK2	1	(Active/Inactive)

Note: Reserved ID bits must be written as "0".

**Byte 1: Control Register**  
(1 = enable, 0 = disable)

Bit	Pin#	Name	PWD	Description
Bit 7	36	SDRAM7	1	(Active/Inactive)
Bit 6	37	SDRAM6	1	(Active/Inactive)
Bit 5	39	SDRAM5	1	(Active/Inactive)
Bit 4	40	SDRAM4	1	(Active/Inactive)
Bit 3	42	SDRAM3	1	(Active/Inactive)
Bit 2	43	SDRAM2	1	(Active/Inactive)
Bit 1	45	SDRAM1	1	(Active/Inactive)
Bit 0	46	SDRAM0	1	(Active/Inactive)

**Notes:**

1. Inactive means outputs are held LOW and are disabled from switching. These outputs are designed to be configured at power-on and are not expected to be configured during the normal modes of operation.
2. PWD = Power on Default

**Byte 2: Control Register**  
 (1 = enable, 0 = disable)

Bit	Pin#	Name	PWD	Description
Bit 7	9	3V66-2 (AGP)	1	(Active/Inactive)
Bit 6	20	PCICLK5	1	(Active/Inactive)
Bit 5	19	PCICLK4	1	(Active/Inactive)
Bit 4	18	PCICLK3	1	(Active/Inactive)
Bit 3	16	PCICLK2	1	(Active/Inactive)
Bit 2	15	PCICLK1	1	(Active/Inactive)
Bit 1	13	PCICLK0	1	(Active/Inactive)
Bit 0	-	Undefined bit	X	(Active/Inactive)

**Notes:**

1. Inactive means outputs are held LOW and are disabled from switching. These outputs are designed to be configured at power-on and are not expected to be configured during the normal modes of operation.
2. PWD = Power on Default
3. Undefined bit can be written with either a "1" or "0".

**Byte 3: ICS Reserved Functionality and frequency select register (Default as noted in PWD)**

Bit	Description								PWD
Bit7	ICS Reserved bit (Note 2)								0
Bit6	ICS Reserved bit (Note 2)								0
Bit5	ICS Reserved bit (Note 2)								0
Bit4	ICS Reserved bit (Note 2)								0
Bit3	ICS Reserved bit (Note 2)								0
Bit2	Undefined bit (Note 3)								X
Bit1	Undefined bit (Note 3)								X
Bit 0	Bit 0	FS0	FS1	CPUCLK MHz	SDRAM MHz	3V66 MHz	PCICLK MHz	IOAPIC MHz	0 Note 1
	0	0	0	66.66	100.0	66.66	33.33	33.33	
	0	1	0	100.0	100.0	66.66	33.33	33.33	
	0	0	1	133.32	133.32	66.66	33.33	33.33	
	0	1	1	133.32	100.0	66.66	33.33	33.33	
	1	0	0	66.66	100.0	66.66	33.33	33.33	
	1	1	0	100.0	100.0	66.66	33.33	33.33	
	1	0	1	133.32	133.32	66.66	33.33	33.33	
	1	1	1	133.32	133.32	66.66	33.33	33.33	

**Note 1:** For system operation, the BSEL lines of the CPU will program FS0, FS2 for the appropriate CPU speed, always with SDRAM = 100MHz. After BIOS verifies the SDRAM is PC133 speed, then bit 0 can be written from the default 0 to 1 to change the SDRAM output frequency from 100MHz to 133MHz. This will only change if the CPU is at the 133MHz FSB speed as shown in this table. The CPU, 3v66, PCI, and IOAPIC clocks will be glitch free during this transition, and only SDRAM will change.

**Note 2:** "ICS RESERVED BITS" must be written as "0".

**Note3:** Undefined bits can be written either as "1 or 0"

**Byte 4: Reserved Register**  
(1 = enable, 0 = disable)

Bit	Pin#	Name	PWD	Description
Bit 7	-	Reserved	0	(Active/Inactive)
Bit 6	-	Reserved	0	(Active/Inactive)
Bit 5	-	Reserved	0	(Active/Inactive)
Bit 4	-	Reserved	0	(Active/Inactive)
Bit 3	-	Reserved	0	(Active/Inactive)
Bit 2	-	Reserved	0	(Active/Inactive)
Bit 1	-	Reserved	0	(Active/Inactive)
Bit 0	-	Reserved	0	(Active/Inactive)

**Byte 5: Reserved Register**  
(1 = enable, 0 = disable)

Bit	Pin#	Name	PWD	Description
Bit 7	-	Reserved	0	(Active/Inactive)
Bit 6	-	Reserved	0	(Active/Inactive)
Bit 5	-	Reserved	0	(Active/Inactive)
Bit 4	-	Reserved	0	(Active/Inactive)
Bit 3	-	Reserved	0	(Active/Inactive)
Bit 2	-	Reserved	0	(Active/Inactive)
Bit 1	-	Reserved	0	(Active/Inactive)
Bit 0	-	Reserved	0	(Active/Inactive)

**Notes:**

1. Inactive means outputs are held LOW and are disabled from switching. These outputs are designed to be configured at power-on and are not expected to be configured during the normal modes of operation.
2. PWD = Power on Default

**Group Timing Relationship Table<sup>1</sup>**

Group	CPU 66MHz SDRAM 100MHz		CPU 100MHz SDRAM 100MHz		CPU 133MHz SDRAM 100MHz		CPU 133MHz SDRAM 133MHz	
	Offset	Tolerance	Offset	Tolerance	Offset	Tolerance	Offset	Tolerance
CPU to SDRAM	2.5ns	500ps	5.0ns	500ps	0.0ns	500ps	3.75ns	500ps
CPU to 3V66	7.5ns	500ps	5.0ns	500ps	0.0ns	500ps	0.0ns	500ps
SDRAM to 3V66	0.0ns	500ps	0.0ns	500ps	0.0ns	500ps	3.75ns	500ps
3V66 to PCI	1.5-3.5ns	N/A	1.5-3.5ns	N/A	1.5-3.5ns	N/A	1.5 -3.5ns	N/A
IOAPIC to PCI	0.0ns	1.0ns	0.0ns	1.0ns	0.0ns	1.0ns	0.0ns	1.0ns
USB & DOT	Asynch	N/A	Asynch	N/A	Asynch	N/A	Asynch	N/A

## Absolute Maximum Ratings

Core Supply Voltage	4.6 V
I/O Supply Voltage	3.6V
Logic Inputs	GND -0.5 V to V <sub>DD</sub> +0.5 V
Ambient Operating Temperature	0°C to +70°C
Storage Temperature	-65°C to +150°C

Stresses above those listed under *Absolute Maximum Ratings* may cause permanent damage to the device. These ratings are stress specifications only and functional operation of the device at these or any other conditions above those listed in the operational sections of the specifications is not implied. Exposure to absolute maximum rating conditions for extended periods may affect product reliability.

## Electrical Characteristics - Input/Supply/Common Output Parameters

T<sub>A</sub> = 0 - 70°C; Supply Voltage V<sub>DD</sub> = 3.3 V +/-5%, V<sub>DDL</sub> = 2.5 V +/-5% (unless otherwise stated)

PARAMETER	SYMBOL	CONDITIONS	MIN	TYP	MAX	UNITS	
Input High Voltage	V <sub>IH</sub>		2		V <sub>DD</sub> +0.3	V	
Input Low Voltage	V <sub>IL</sub>		V <sub>SS</sub> -0.3		0.8	V	
Input High Current	I <sub>IH</sub>	V <sub>IN</sub> = V <sub>DD</sub>	-5		5	μA	
Input Low Current	I <sub>IL1</sub>	V <sub>IN</sub> = 0 V; Inputs with no pull-up resistors	-5	2		μA	
	I <sub>IL2</sub>	V <sub>IN</sub> = 0 V; Inputs with pull-up resistors	-200	-100			
Operating Supply Current	I <sub>DD3.3OP</sub>	C <sub>L</sub> = 0 pF; Select @ 66 MHz		97	115	mA	
		C <sub>L</sub> = 0 pF; Select @ 100 MHz		91	110		
		C <sub>L</sub> = 0 pF; Select @ 133 MHz		100	165		
		C <sub>L</sub> = Max loads; Select @ 66 MHz		295	330	mA	
		C <sub>L</sub> = Max loads; Select @ 100 MHz		280	320		
	C <sub>L</sub> = Max loads; Select @ 133 MHz		300	395			
	I <sub>DD2.5OP</sub>	C <sub>L</sub> = 0 pF; Select @ 66 MHz			16	19	mA
		C <sub>L</sub> = 0 pF; Select @ 100 MHz			25	35	
		C <sub>L</sub> = 0 pF; Select @ 133 MHz			26	40	
		C <sub>L</sub> = Max loads; Select @ 66 MHz			19	30	mA
C <sub>L</sub> = Max loads; Select @ 100 MHz				34	50		
C <sub>L</sub> = Max loads; Select @ 133 MHz			40	70			
Powerdown Current	I <sub>DD3.3PD</sub>	C <sub>L</sub> = Max loads		220	400	μA	
	I <sub>DD2.5PD</sub>	Input address VDD or GND		<1	10		
Input Frequency	F <sub>i</sub>	V <sub>DD</sub> = 3.3 V	12	14.318	16	MHz	
Pin Inductance	L <sub>pin</sub>			7		nH	
Input Capacitance <sup>1</sup>	C <sub>IN</sub>	Logic Inputs			5	pF	
	C <sub>OUT</sub>	Output pin capacitance		6		pF	
	C <sub>INX</sub>	X1 & X2 pins	27		45	pF	
Transition time <sup>1</sup>	T <sub>trans</sub>	To 1st crossing of target frequency			5	ms	
Settling time <sup>1</sup>	T <sub>s</sub>	From 1st crossing to 1% target frequency			5	ms	
Clk Stabilization <sup>1</sup>	T <sub>STAB</sub>	From V <sub>DD</sub> = 3.3 V to 1% target frequency			5	ms	
Delay <sup>1</sup>	t <sub>PZH,tPZL</sub>	Output enable delay (all outputs)	1		10	ns	
	t <sub>PHZ,tPLZ</sub>	Output disable delay (all outputs)	1		10	ns	

<sup>1</sup>Guaranteed by design, not 100% tested in production.

## Electrical Characteristics - CPU

$T_A = 0 - 70^\circ\text{C}$ ;  $V_{DDL} = 2.5 \text{ V} \pm 5\%$ ;  $C_L = 10\text{-}20 \text{ pF}$  (unless otherwise specified)

PARAMETER	SYMBOL	CONDITIONS	MIN	TYP	MAX	UNITS
Output Impedance	$R_{DSP2B}^1$	$V_O = V_{DD}^*(0.5)$	13.5	22	45	$\Omega$
Output Impedance	$R_{DSN2B}^1$	$V_O = V_{DD}^*(0.5)$	13.5	23	45	$\Omega$
Output High Voltage	$V_{OH2B}$	$I_{OH} = -1 \text{ mA}$	2			V
Output Low Voltage	$V_{OL2B}$	$I_{OL} = 1 \text{ mA}$			0.4	V
Output High Current	$I_{OH2B}$	$V_{OH @ MIN} = 1.0 \text{ V}$	-27	-68		mA
		$V_{OH @ MAX} = 2.375 \text{ V}$		-9	-27	
Output Low Current	$I_{OL2B}$	$V_{OL @ MIN} = 1.2 \text{ V}$	27	54		mA
		$V_{OL @ MAX} = 0.3 \text{ V}$		11	30	
Rise Time <sup>1</sup>	$t_{r2B}$	$V_{OL} = 0.4 \text{ V}$ , $V_{OH} = 2.0 \text{ V}$	0.4	1.1	1.6	ns
Fall Time <sup>1</sup>	$t_{f2B}$	$V_{OH} = 2.0 \text{ V}$ , $V_{OL} = 0.4 \text{ V}$	0.4	1.1	1.6	ns
Duty Cycle <sup>1</sup>	$d_{l2B}$	$V_T = 1.25 \text{ V}$ , 66, 100 MHz	45	50	55	%
		$V_T = 1.25 \text{ V}$ , 133 MHz	45	53	55	
Skew window <sup>1</sup>	$t_{sk2B}$	$V_T = 1.25 \text{ V}$		118	175	ps
Jitter, Cycle-to-cycle <sup>1</sup>	$t_{jycyc-cyc2B}$	$V_T = 1.25 \text{ V}$		148	250	ps

<sup>1</sup>Guaranteed by design, not 100% tested in production.

## Electrical Characteristics - 3V66

$T_A = 0 - 70^\circ\text{C}$ ;  $V_{DD} = 3.3 \text{ V} \pm 5\%$ ;  $C_L = 10\text{-}20 \text{ pF}$  (unless otherwise specified)

PARAMETER	SYMBOL	CONDITIONS	MIN	TYP	MAX	UNITS
Output Impedance	$R_{DSP1}^1$	$V_O = V_{DD}^*(0.5)$	12	17	55	$\Omega$
Output Impedance	$R_{DSN1}^1$	$V_O = V_{DD}^*(0.5)$	12	18	55	$\Omega$
Output High Voltage	$V_{OH1}$	$I_{OH} = -1 \text{ mA}$	2.4			V
Output Low Voltage	$V_{OL1}$	$I_{OL} = 1 \text{ mA}$			0.55	V
Output High Current	$I_{OH1}$	$V_{OH @ MIN} = 1.0 \text{ V}$	-33	-108		mA
		$V_{OH @ MAX} = 3.135 \text{ V}$		-9	-33	
Output Low Current	$I_{OL1}$	$V_{OL @ MIN} = 1.95 \text{ V}$	30	95		mA
		$V_{OL @ MAX} = 0.4 \text{ V}$		29	38	
Rise Time <sup>1</sup>	$t_{r1}$	$V_{OL} = 0.4 \text{ V}$ , $V_{OH} = 2.4 \text{ V}$	0.4	1.2	1.8	ns
Fall Time <sup>1</sup>	$t_{f1}$	$V_{OH} = 2.4 \text{ V}$ , $V_{OL} = 0.4 \text{ V}$	0.4	1.3	1.8	ns
Duty Cycle <sup>1</sup>	$d_{l1}$	$V_T = 1.5 \text{ V}$	45	50	55	%
Skew window <sup>1</sup>	$t_{sk1}$	$V_T = 1.5 \text{ V}$		82	175	ps
Jitter, Cycle-to-cycle <sup>1</sup>	$t_{jycyc-cyc1}$	$V_T = 1.5 \text{ V}$		123	500	ps

<sup>1</sup>Guaranteed by design, not 100% tested in production.

## Electrical Characteristics - IOAPIC

$T_A = 0 - 70^\circ\text{C}$ ;  $V_{DDL} = 2.5 \text{ V} \pm 5\%$ ;  $C_L = 10\text{-}20 \text{ pF}$  (unless otherwise specified)

PARAMETER	SYMBOL	CONDITIONS	MIN	TYP	MAX	UNITS
Output Impedance	$R_{DSP4B}^1$	$V_O = V_{DD}^*(0.5)$	9	21.5	30	$\Omega$
Output Impedance	$R_{DSN4B}^1$	$V_O = V_{DD}^*(0.5)$	9	23	30	$\Omega$
Output High Voltage	$V_{OH4B}$	$I_{OH} = -1 \text{ mA}$	2			V
Output Low Voltage	$V_{OL4B}$	$I_{OL} = 1 \text{ mA}$			0.4	V
Output High Current	$I_{OH4B}$	$V_{OH @ MIN} = 1.0 \text{ V}$	-27	-68		mA
		$V_{OH @ MAX} = 2.375 \text{ V}$		-9	-27	
Output Low Current	$I_{OL4B}$	$V_{OL @ MIN} = 1.2 \text{ V}$	27	54		mA
		$V_{OL @ MAX} = 0.3 \text{ V}$		11	30	
Rise Time <sup>1</sup>	$t_{r4B}$	$V_{OL} = 0.4 \text{ V}, V_{OH} = 2.0 \text{ V}$	0.4	1.1	1.6	ns
Fall Time <sup>1</sup>	$t_{f4B}$	$V_{OH} = 2.0 \text{ V}, V_{OL} = 0.4 \text{ V}$	0.4	1.1	1.6	ns
Duty Cycle <sup>1</sup>	$d_{t4B}$	$V_T = 1.25 \text{ V}$	45	50	55	%
Jitter, Cycle-to-cycle <sup>1</sup>	$t_{j\text{cyc-cyc}4B}$	$V_T = 1.25 \text{ V}$		123	500	ps

<sup>1</sup>Guaranteed by design, not 100% tested in production.

## Electrical Characteristics - SDRAM

$T_A = 0 - 70^\circ\text{C}$ ;  $V_{DD} = 3.3 \text{ V} \pm 5\%$ ;  $C_L = 20\text{-}30 \text{ pF}$  (unless otherwise specified)

PARAMETER	SYMBOL	CONDITIONS	MIN	TYP	MAX	UNITS
Output Impedance	$R_{DSP3}^1$	$V_O = V_{DD}^*(0.5)$	10	14	24	$\Omega$
Output Impedance	$R_{DSN3}^1$	$V_O = V_{DD}^*(0.5)$	10	18	24	$\Omega$
Output High Voltage	$V_{OH3}$	$I_{OH} = -1 \text{ mA}$	2.4			V
Output Low Voltage	$V_{OL3}$	$I_{OL} = 1 \text{ mA}$			0.4	V
Output High Current	$I_{OH3}$	$V_{OH @ MIN} = 2.0 \text{ V}$	-54	-92		mA
		$V_{OH @ MAX} = 3.135 \text{ V}$		-16	-46	
Output Low Current	$I_{OL3}$	$V_{OL @ MIN} = 1.0 \text{ V}$	54	68		mA
		$V_{OL @ MAX} = 0.4 \text{ V}$		29	53	
Rise Time <sup>1</sup>	$t_{r3}$	$V_{OL} = 0.4 \text{ V}, V_{OH} = 2.4 \text{ V}$	0.4	1	1.6	ns
Fall Time <sup>1</sup>	$t_{f3}$	$V_{OH} = 2.4 \text{ V}, V_{OL} = 0.4 \text{ V}$	0.4	1.5	1.6	ns
Duty Cycle <sup>1</sup>	$d_{t3}$	$V_T = 1.5 \text{ V}$	45	52	55	%
Skew window <sup>1</sup>	$t_{sk3}$	$V_T = 1.5 \text{ V}$		164	250	ps
Jitter, Cycle-to-cycle <sup>1</sup>	$t_{j\text{cyc-cyc}3}$	$V_T = 1.5 \text{ V}, 66, 100 \text{ MHz}$		180	250	ps

<sup>1</sup>Guaranteed by design, not 100% tested in production.

## Electrical Characteristics - PCI

$T_A = 0 - 70^\circ\text{C}$ ;  $V_{DD} = 3.3 \text{ V} \pm 5\%$ ;  $C_L = 10\text{-}30 \text{ pF}$  (unless otherwise specified)

PARAMETER	SYMBOL	CONDITIONS	MIN	TYP	MAX	UNITS
Output Impedance	$R_{DSP1}^1$	$V_O = V_{DD}*(0.5)$	12	14	55	$\Omega$
Output Impedance	$R_{DSN1}^1$	$V_O = V_{DD}*(0.5)$	12	18	55	$\Omega$
Output High Voltage	$V_{OH1}$	$I_{OH} = -1 \text{ mA}$	2.4			V
Output Low Voltage	$V_{OL1}$	$I_{OL} = 1 \text{ mA}$			0.55	V
Output High Current	$I_{OH1}$	$V_{OH @ MIN} = 1.0 \text{ V}$	-33	-106		mA
		$V_{OH @ MAX} = 3.135 \text{ V}$		-14	-33	
Output Low Current	$I_{OL1}$	$V_{OL @ MIN} = 1.95 \text{ V}$	30	94		mA
		$V_{OL @ MAX} = 0.4 \text{ V}$		29	38	
Rise Time <sup>1</sup>	$t_{r1}$	$V_{OL} = 0.4 \text{ V}, V_{OH} = 2.4 \text{ V}$	0.4	1.3	2	ns
Fall Time <sup>1</sup>	$t_{f1}$	$V_{OH} = 2.4 \text{ V}, V_{OL} = 0.4 \text{ V}$	0.4	1.4	2	ns
Duty Cycle <sup>1</sup>	$d_{t1}$	$V_T = 1.5 \text{ V}$	45	52	55	%
Skew window <sup>1</sup>	$t_{sk1}$	$V_T = 1.5 \text{ V}$		304	500	ps
Jitter, Cycle-to-cycle <sup>1</sup>	$t_{j\text{cyc-cyc}1}$	$V_T = 1.5 \text{ V}$		170	500	ps

<sup>1</sup>Guaranteed by design, not 100% tested in production.

## Electrical Characteristics - REF, 48MHz\_0 (Pin 25)

$T_A = 0 - 70^\circ\text{C}$ ;  $V_{DD} = 3.3 \text{ V} \pm 5\%$ ;  $C_L = 10\text{-}20 \text{ pF}$  (unless otherwise specified)

PARAMETER	SYMBOL	CONDITIONS	MIN	TYP	MAX	UNITS
Output Impedance	$R_{DSP5}^1$	$V_O = V_{DD}*(0.5)$	20	32.6	60	$\Omega$
Output Impedance	$R_{DSN5}^1$	$V_O = V_{DD}*(0.5)$	20	31	60	$\Omega$
Output High Voltage	$V_{OH15}$	$I_{OH} = -1 \text{ mA}$	2.4			V
Output Low Voltage	$V_{OL5}$	$I_{OL} = 1 \text{ mA}$			0.55	V
Output High Current	$I_{OH5}$	$V_{OH @ MIN} = 1.0 \text{ V}$	-29	-54		mA
		$V_{OH @ MAX} = 3.135 \text{ V}$		-11	-23	
Output Low Current	$I_{OL5}$	$V_{OL @ MIN} = 1.95 \text{ V}$	29	54		mA
		$V_{OL @ MAX} = 0.4 \text{ V}$		16	27	
Rise Time <sup>1</sup>	$t_{r5}$	$V_{OL} = 0.4 \text{ V}, V_{OH} = 2.4 \text{ V}$	0.4	1.4	4	ns
Fall Time <sup>1</sup>	$t_{f5}$	$V_{OH} = 2.4 \text{ V}, V_{OL} = 0.4 \text{ V}$	0.4	1.7	4	ns
Duty Cycle <sup>1</sup>	$d_{t5}$	$V_T = 1.5 \text{ V}$	45	53	55	%
Jitter, Cycle-to-cycle <sup>1</sup>	$t_{j\text{cyc-cyc}5}$	$V_T = 1.5 \text{ V}, \text{Fixed clocks}$		215	500	ps
Jitter, Cycle-to-cycle <sup>1</sup>	$t_{j\text{cyc-cyc}5}$	$V_T = 1.5 \text{ V}, \text{Ref clocks}$		930	1000	ps

<sup>1</sup>Guaranteed by design, not 100% tested in production.

**Electrical Characteristics - 48MHz\_1 (Pin 26)**

$T_A = 0 - 70^\circ\text{C}$ ;  $V_{DD} = 3.3 \text{ V} \pm 5\%$ ;  $C_L = 10\text{-}15 \text{ pF}$  (unless otherwise specified)

PARAMETER	SYMBOL	CONDITIONS	MIN	TYP	MAX	UNITS
Output Impedance	$R_{DSP3}^1$	$V_O = V_{DD}^*(0.5)$	10	16.7	24	$\Omega$
Output Impedance	$R_{DSN3}^1$	$V_O = V_{DD}^*(0.5)$	10	18.4	24	$\Omega$
Output High Voltage	$V_{OH3}$	$I_{OH} = -1 \text{ mA}$	2.4			V
Output Low Voltage	$V_{OL3}$	$I_{OL} = 1 \text{ mA}$			0.55	V
Output High Current	$I_{OH3}$	$V_{OH @ MIN} = 2.0 \text{ V}$	-54	-82		mA
		$V_{OH @ MAX} = 3.135 \text{ V}$		-20	-46	
Output Low Current	$I_{OL3}$	$V_{OL @ MIN} = 1.0 \text{ V}$	54	95		mA
		$V_{OL @ MAX} = 0.4 \text{ V}$		28	53	
Rise Time <sup>1</sup>	$t_{r3}$	$V_{OL} = 0.4 \text{ V}, V_{OH} = 2.4 \text{ V}$	0.4	1.1	1.6	ns
Fall Time <sup>1</sup>	$t_{f3}$	$V_{OH} = 2.4 \text{ V}, V_{OL} = 0.4 \text{ V}$	0.4	1.1	1.6	ns
Duty Cycle <sup>1</sup>	$d_{f3}$	$V_T = 1.5 \text{ V}$	45	51	55	%
Skew	$t_{sk3}$	$V_T = 1.5 \text{ V}$		116	250	ps
Jitter, Cycle-to-cycle <sup>1</sup>	$t_{jcyc-cyc3B}$	$V_T = 1.5 \text{ V}$		196	500	ps

<sup>1</sup>Guaranteed by design, not 100% tested in production.

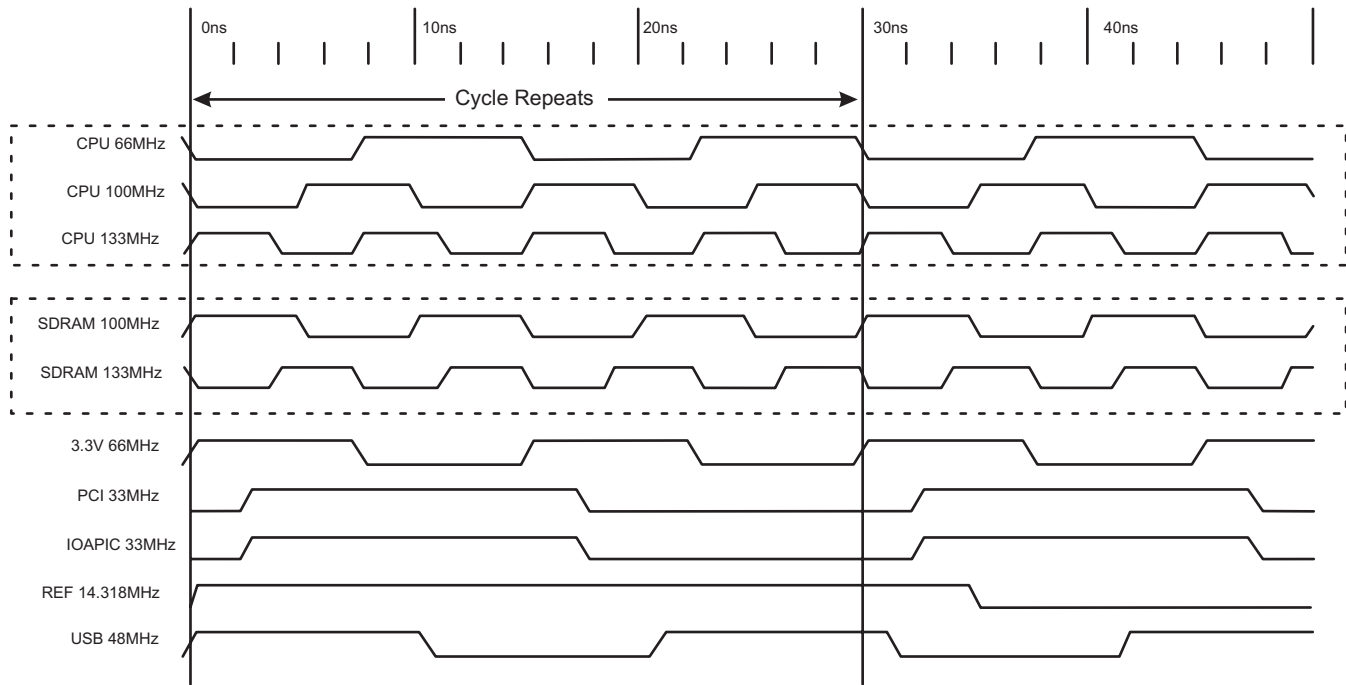

**Group Offset Waveforms**

## General I<sup>2</sup>C serial interface information

The information in this section assumes familiarity with I<sup>2</sup>C programming.

### How to Write:

- Controller (host) sends a start bit.
- Controller (host) sends the write address D2<sub>(H)</sub>
- ICS clock will *acknowledge*
- Controller (host) sends a dummy command code
- ICS clock will *acknowledge*
- Controller (host) sends a dummy byte count
- ICS clock will *acknowledge*
- Controller (host) starts sending first byte (Byte 0) through byte 5
- ICS clock will *acknowledge* each byte *one at a time*.

How to Write:	
Controller (Host)	ICS (Slave/Receiver)
Start Bit	
Address D2 <sub>(H)</sub>	
	<b>ACK</b>
Dummy Command Code	
	<b>ACK</b>
Dummy Byte Count	
	<b>ACK</b>
Byte 0	
	<b>ACK</b>
Byte 1	
	<b>ACK</b>
Byte 2	
	<b>ACK</b>
Byte 3	
	<b>ACK</b>
Byte 4	
	<b>ACK</b>
Byte 5	
	<b>ACK</b>
Stop Bit	

### How to Read:

- Controller (host) will send start bit.
- Controller (host) sends the read address D3<sub>(H)</sub>
- ICS clock will *acknowledge*
- ICS clock will send the *byte count*
- Controller (host) acknowledges
- ICS clock sends first byte (*Byte 0*) through *byte 5*
- Controller (host) will need to acknowledge each byte
- Controller (host) will send a stop bit

How to Read:	
Controller (Host)	ICS (Slave/Receiver)
Start Bit	
Address D3 <sub>(H)</sub>	
	<b>ACK</b>
	<b>Byte Count</b>
ACK	
	<b>Byte 0</b>
ACK	
	<b>Byte 1</b>
ACK	
	<b>Byte 2</b>
ACK	
	<b>Byte 3</b>
ACK	
	<b>Byte 4</b>
ACK	
	<b>Byte 5</b>
ACK	
Stop Bit	

### Notes:

1. The ICS clock generator is a slave/receiver, I<sup>2</sup>C component. It can read back the data stored in the latches for verification. **Read-Back will support Intel PIIX4 "Block-Read" protocol.**
2. The data transfer rate supported by this clock generator is 100K bits/sec or less (standard mode)
3. The input is operating at 3.3V logic levels.
4. The data byte format is 8 bit bytes.
5. To simplify the clock generator I<sup>2</sup>C interface, the protocol is set to use only "**Block-Writes**" from the controller. The bytes must be accessed in sequential order from lowest to highest byte with the ability to stop after any complete byte has been transferred. The Command code and Byte count shown above must be sent, but the data is ignored for those two bytes. The data is loaded until a Stop sequence is issued.
6. At power-on, all registers are set to a default condition, as shown.

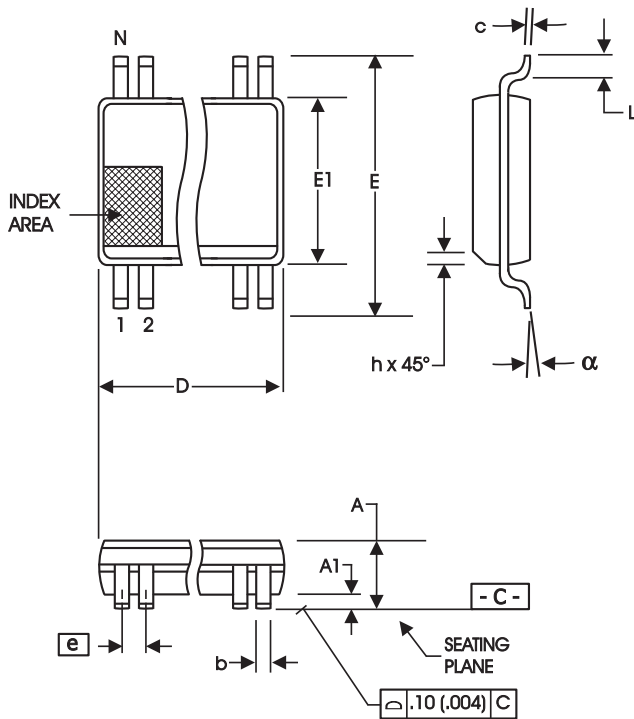

56-Lead, 300 mil Body, 25 mil, SSOP

SYMBOL	In Millimeters COMMON DIMENSIONS		In Inches COMMON DIMENSIONS	
	MIN	MAX	MIN	MAX
A	2.41	2.80	.095	.110
A1	0.20	0.40	.008	.016
b	0.20	0.34	.008	.0135
c	0.13	0.25	.005	.010
D	SEE VARIATIONS		SEE VARIATIONS	
E	10.03	10.68	.395	.420
E1	7.40	7.60	.291	.299
e	0.635 BASIC		0.025 BASIC	
h	0.38	0.64	.015	.025
L	0.50	1.02	.020	.040
N	SEE VARIATIONS		SEE VARIATIONS	
alpha	0°	8°	0°	8°

VARIATIONS

N	D mm.		D (inch)	
	MIN	MAX	MIN	MAX
56	18.31	18.55	.720	.730

Reference Doc.: JEDEC Publication 95, MO-118

10-0034

## Ordering Information

9250yF-27LF-T

Example:

XXXX y F - PPP LF - T

- XXXX — Device Type (consists of 3 to 7 digit numbers)
- y — Revision Designator (will not correlate with datasheet revision)
- F — Package Type  
F=SSOP
- PPP — Pattern Number (2 or 3 digit number for parts with ROM code patterns)
- LF — RoHS Compliant (Optional)
- T — Designation for tape and reel packaging

**Revision History**

Rev.	Issue Date	Description	Page #
C	8/17/2005	Added LF Ordering Information	14
D	10/25/2005	Removed "Contact ICS for an I <sup>2</sup> C programming application" note reference.	13
E	9/11/2008	Corrected typo on pin# 28/29 pin description	2
F	1/25/2010	Updated document template	

---

**Innovate with IDT and accelerate your future networks. Contact:**

[www.IDT.com](http://www.IDT.com)

**For Sales**

800-345-7015  
408-284-8200  
Fax: 408-284-2775

**For Tech Support**

408-284-6578  
pcclockhelp@idt.com

**Corporate Headquarters**

Integrated Device Technology, Inc.  
6024 Silver Creek Valley Road  
San Jose, CA 95138  
United States  
800 345 7015  
+408 284 8200 (outside U.S.)

**Asia Pacific and Japan**

Integrated Device Technology  
Singapore (1997) Pte. Ltd.  
Reg. No. 199707558G  
435 Orchard Road  
#20-03 Wisma Atria  
Singapore 238877  
+65 6 887 5505

**Europe**

IDT Europe, Limited  
Prime House  
Barnett Wood Lane  
Leatherhead, Surrey  
United Kingdom KT22 7DE  
+44 1372 363 339





[www.IDT.com](http://www.IDT.com)

© 2009 Integrated Device Technology, Inc. All rights reserved. Product specifications subject to change without notice. IDT, ICS, and the IDT logo are trademarks of Integrated Device Technology, Inc. Accelerated Thinking is a service mark of Integrated Device Technology, Inc. All other brands, product names and marks are or may be trademarks or registered trademarks used to identify products or services of their respective owners.  
Printed in USA

## Looking for pricing, stock, or lifecycle information?

Click below to explore more details on WIN SOURCE:

-  [View ICS9250BF-27LFT on WIN SOURCE](#)
-  [IDT, Integrated Device Technology Inc Information](#)

## Optimize Your Supply Chain with WIN SOURCE Solutions

-  Global Sourcing Solution
-  Obsolete Management
-  Cost Control Management
-  Shortage Management
-  Alternative Solution
-  Excess Inventory Management