



# THE DATASHEET OF CMD245C4





# CMD245C4

## 6-18 GHz Low Phase Noise Amplifier

### Product Overview

The CMD245C4 is a wideband GaAs MMIC low phase noise amplifier housed in a leadless surface mount package that is ideally suited for military, space, and communications systems. At 10 GHz the device delivers 18 dB of gain, a saturated output power of +21 dBm and a noise figure of 4.5 dB. Also, with an input signal of 10 GHz the amplifier provides low phase noise performance of -165 dBc/Hz at 10 kHz offset. The CMD245C4 is a 50 ohm matched design which eliminates the need for RF port matching.

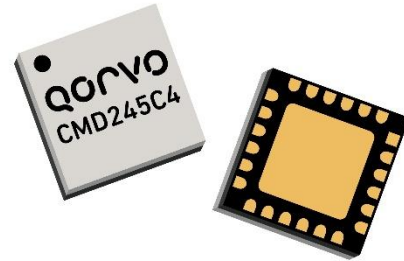

### Functional Block Diagram

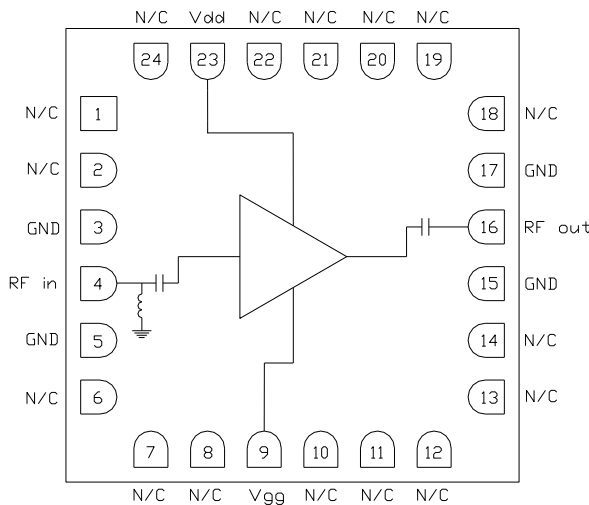

### Key Features

- Wide Bandwidth
- Low Phase Noise
- Low Current Consumption
- Pb-Free RoHS Compliant 4x4 mm SMT Package

### Ordering Information

Part No.	Description
CMD245C4	250 Piece 7" Reel
CMD245C4-EVB	Evaluation Board

### Electrical Performance ( $V_{dd} = 5.0\text{ V}$ , $V_{gg} = 3.0\text{ V}$ , $T_A = 25^\circ\text{ C}$ , $F = 10\text{ GHz}$ )

Parameter	Min	Typ.	Max	Units
Frequency Range		5 - 20		GHz
Gain		18		dB
Input Return Loss		10		dB
Output Return Loss		12		dB
Noise Figure		4.5		dB
Output $P_{1dB}$		18		dBm
Saturated Output Power		21		dBm
Phase Noise @ 10 kHz Offset		-165		dBc/Hz
Supply Current		76		mA

### Absolute Maximum Ratings

Parameter	Rating
Drain Voltage, $V_{dd}$	8.0 V
Gate Voltage, $V_{gg}$	5.0 V
RF Input Power	+17 dBm
Channel Temperature, $T_{ch}$	150° C
Power Dissipation, $P_{diss}$	602 mW
Thermal Resistance, $\theta_{JC}$	108° C/W
Operating Temperature	-40 to 85° C
Storage Temperature	-55 to 150° C

Operation of this device outside the maximum ratings may cause permanent damage.

### Recommended Operating Conditions

Parameter	Min	Typ.	Max	Units
$V_{dd}$	3.0	5.0	7.0	V
$I_{dd}$		76		mA
$V_{gg}$	0	3.0	4.0	V

Electrical performance is measured at specific test conditions. Electrical specifications are not guaranteed over all recommended operating conditions.

### Electrical Specifications ( $V_{dd} = 5.0$ V, $V_{gg} = 3.0$ V, $T_A = 25^\circ$ C)

Parameter	Min	Typ.	Max	Min	Typ.	Max	Units
Frequency Range		6 - 12			12 - 18		GHz
Gain	15	18	21.5	14	17.5	21.5	dB
Noise Figure		5			6		dB
Input Return Loss		10			15		dB
Output Return Loss		13			12		dB
Output $P_{1dB}$	15	19		11	16		dBm
Saturated Output Power		21			20		dBm
Output IP3		29			29		dBm
Phase Noise @ 10 kHz Offset		-165			-165		dBc/Hz
Supply Current	53	76	100	53	76	100	mA

Typical Performance

Broadband Performance,  $V_{dd} = 5.0\text{ V}$ ,  $V_{gg} = 3.0\text{ V}$ ,  $I_{dd} = 76\text{ mA}$ ,  $T_A = 25^\circ\text{C}$

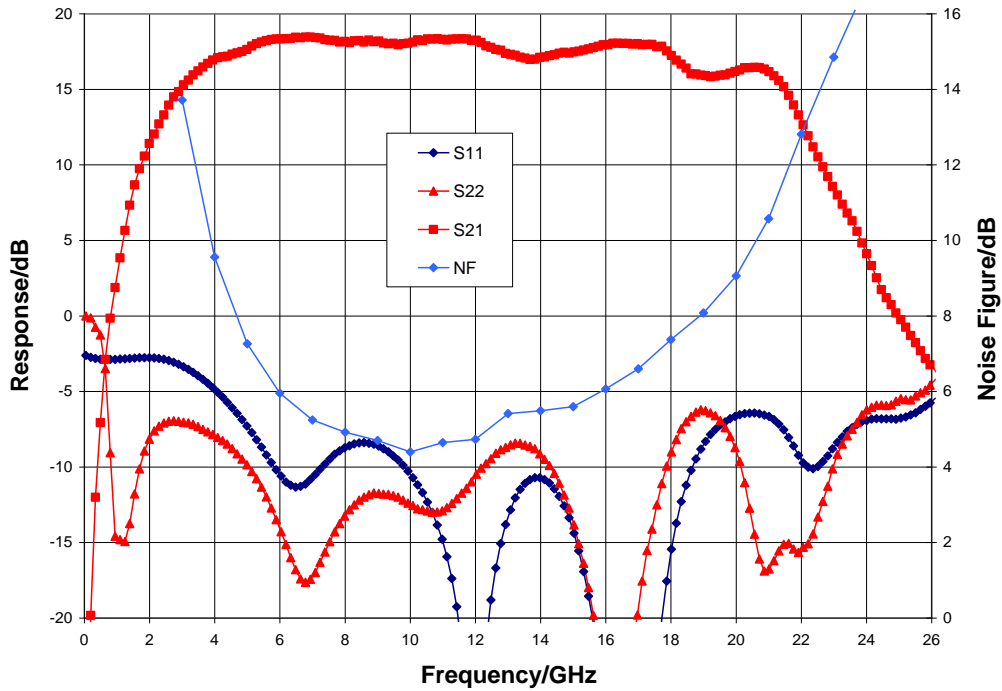

Narrow-band Performance,  $V_{dd} = 5.0\text{ V}$ ,  $V_{gg} = 3.0\text{ V}$ ,  $I_{dd} = 76\text{ mA}$ ,  $T_A = 25^\circ\text{C}$

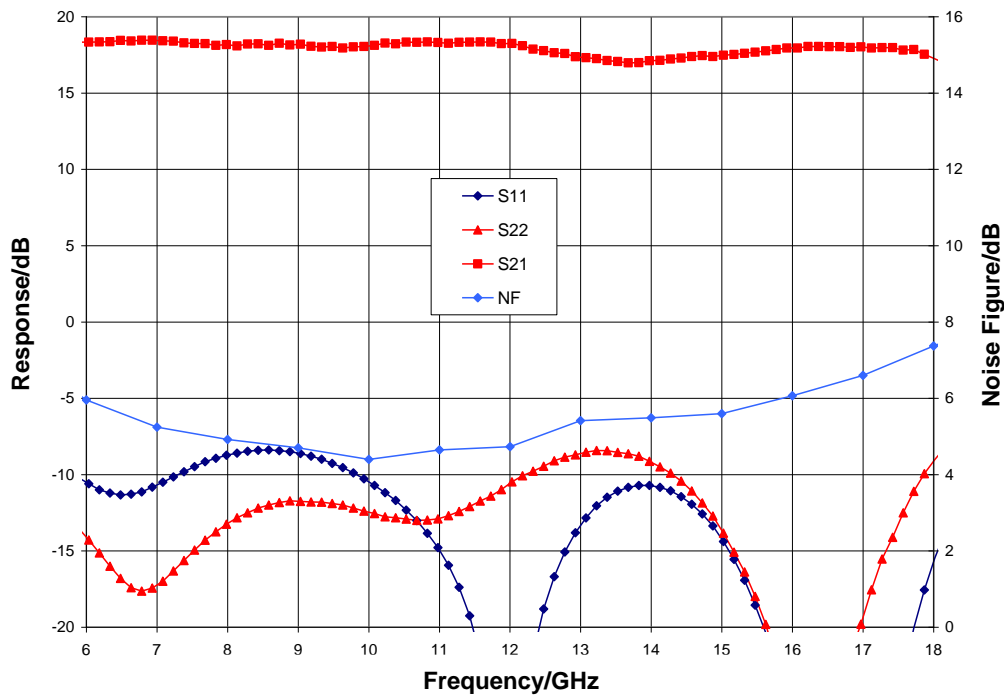

Typical Performance

Additive Phase Noise @ P<sub>sat</sub>, V<sub>dd</sub> = 5.0 V, V<sub>gg</sub> = 3.0 V, T<sub>A</sub> = 25° C

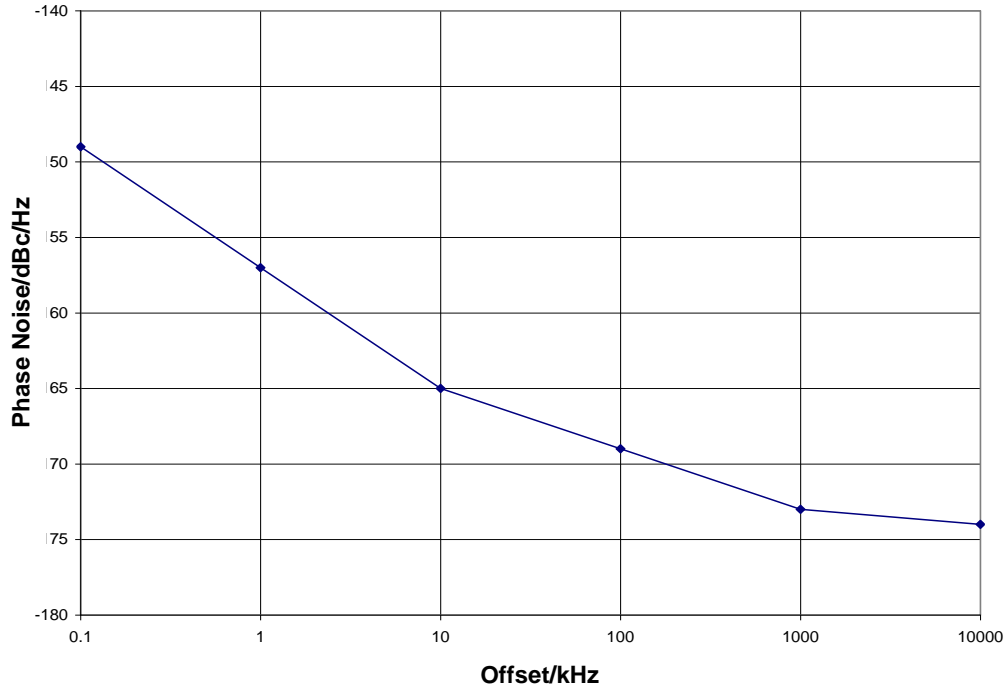

Gain vs. Temperature, V<sub>dd</sub> = 5.0 V, V<sub>gg</sub> = 3.0 V

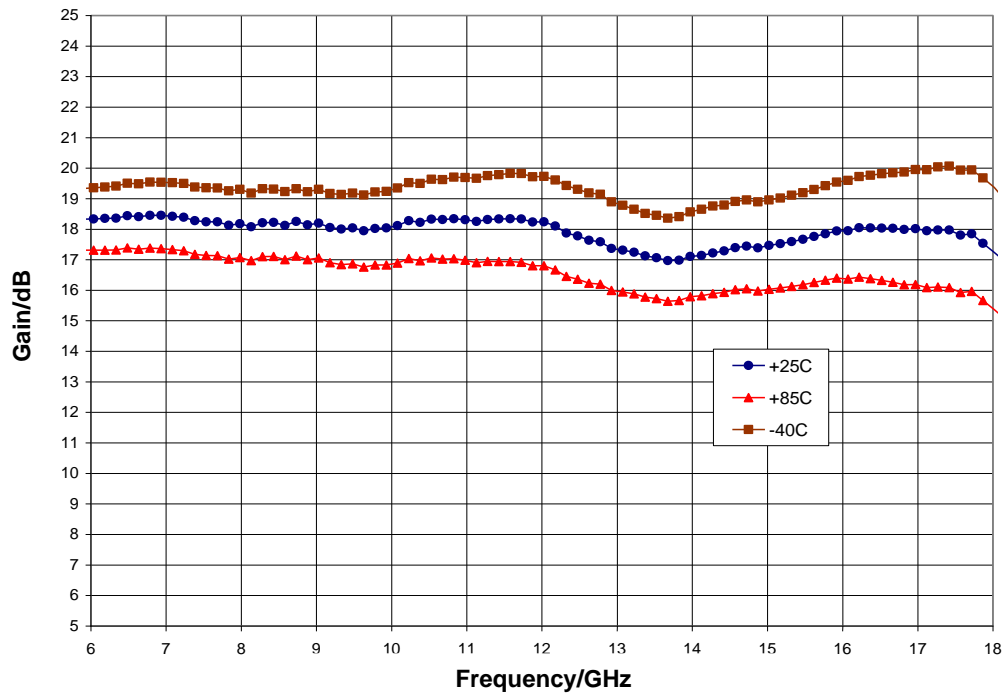

Typical Performance

Output Power,  $V_{dd} = 5.0\text{ V}$ ,  $V_{gg} = 3.0\text{ V}$ ,  $T_A = 25^\circ\text{ C}$

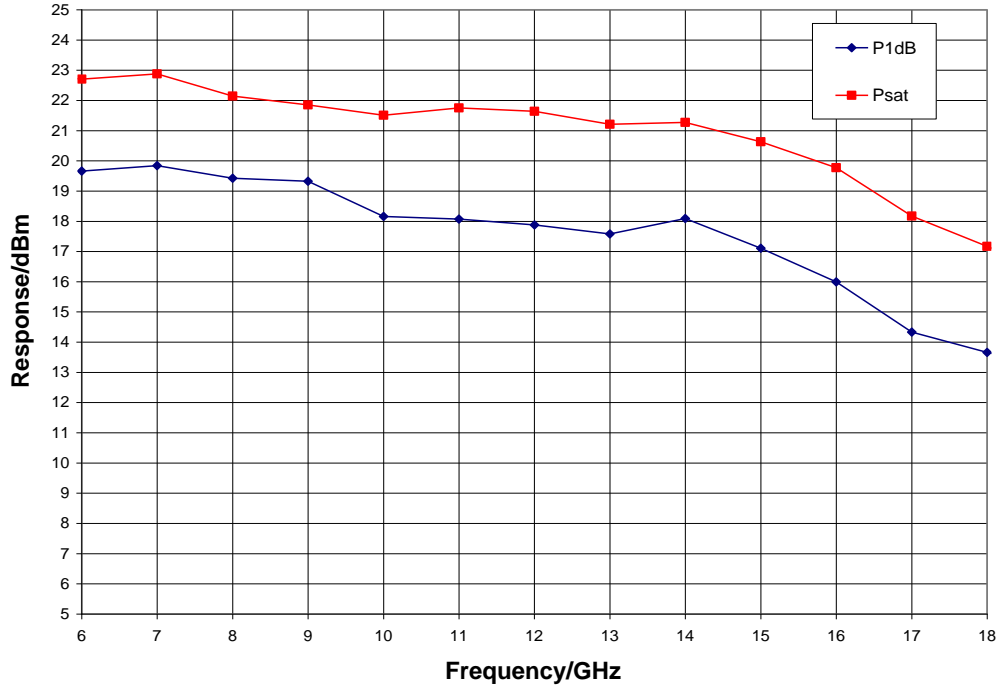

P1dB vs. Temperature,  $V_{dd} = 5.0\text{ V}$ ,  $V_{gg} = 3.0\text{ V}$

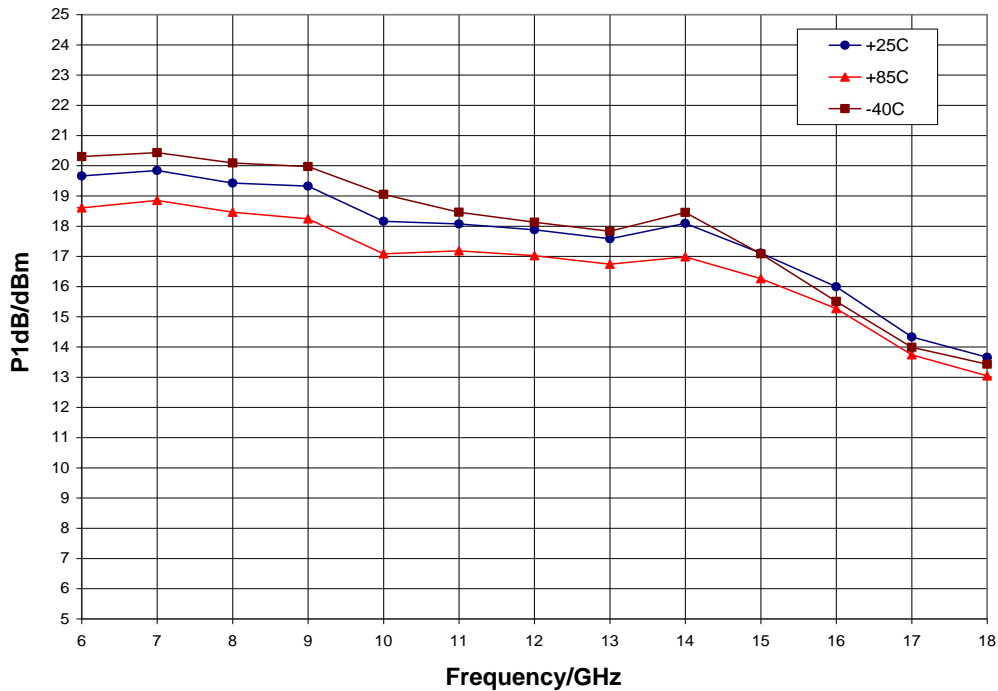

Typical Performance

Output IP3 vs. Temperature,  $V_{dd} = 5.0\text{ V}$ ,  $V_{gg} = 3.0\text{ V}$

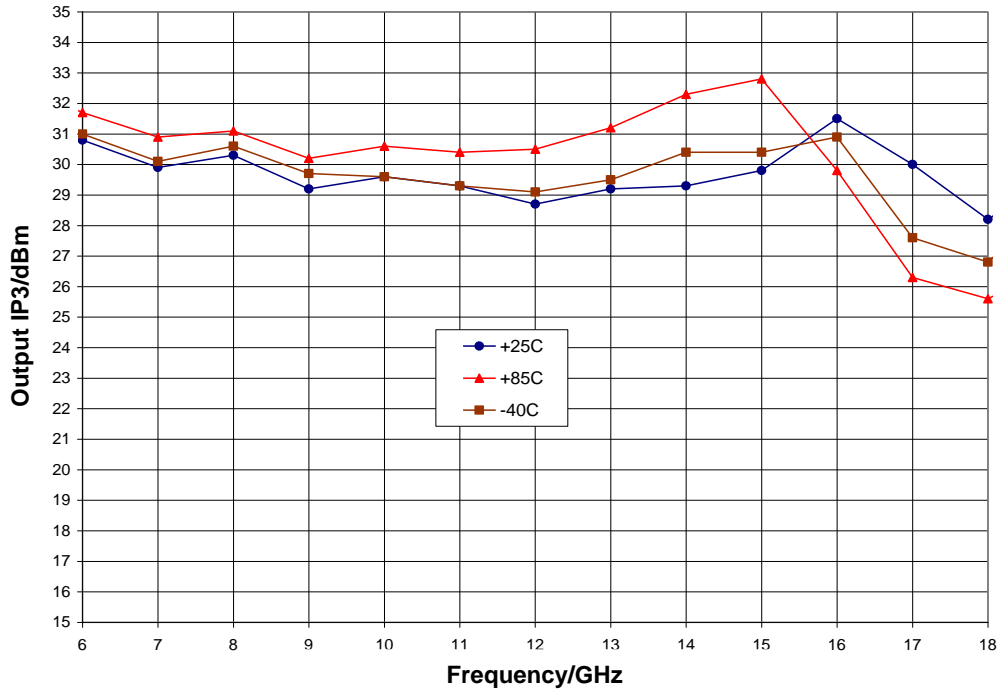

Noise Figure vs. Temperature,  $V_{dd} = 5.0\text{ V}$ ,  $V_{gg} = 3.0\text{ V}$

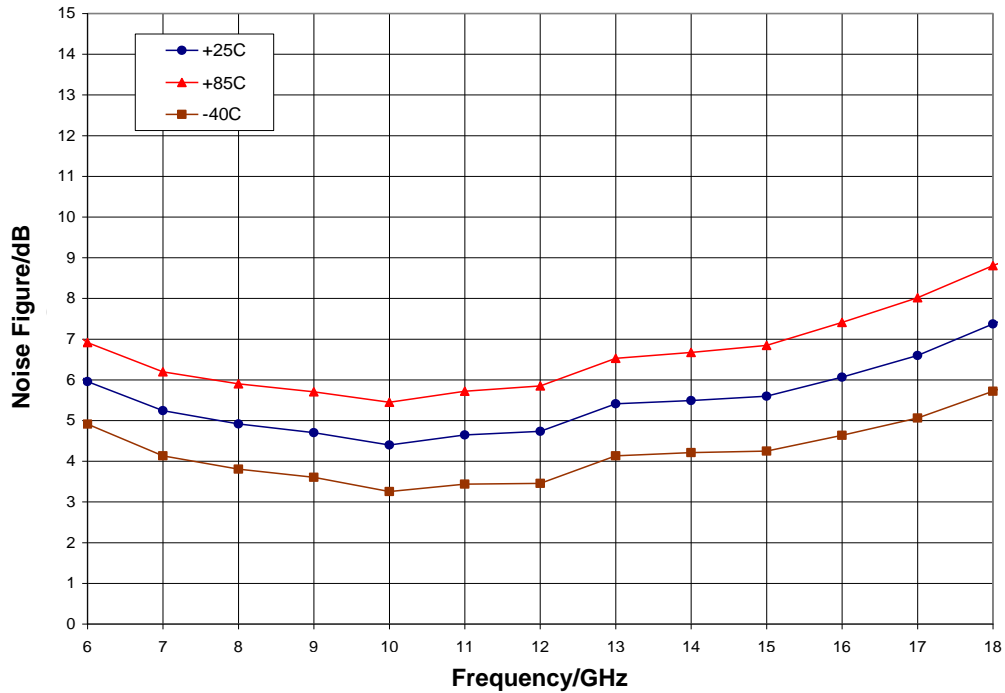

## Mechanical Information

### Package Information and Dimensions

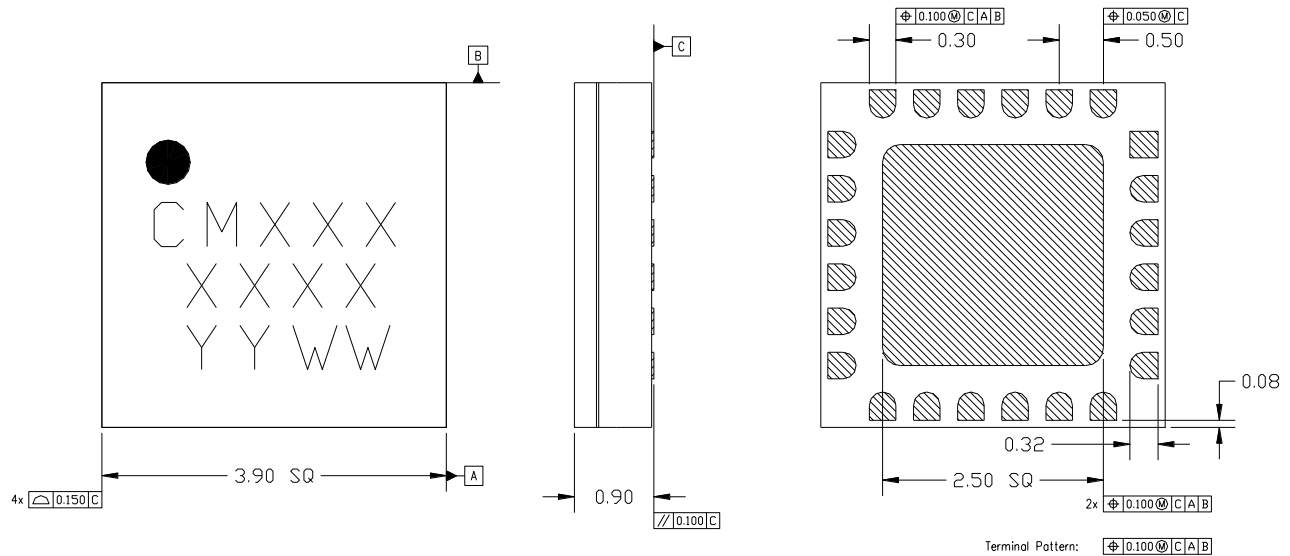

**Notes:**

1. All dimensions shown in mm.
2. Material: Black alumina
3. Lead finish
  - 3.1. Ni: 8.89um max, 1.27um min
  - 3.2. Pd: 0.17um max, 0.07um min
  - 3.3. Au: 0.254um max, 0.03um min
4. Marking
  - 4.1. Line 1: Part number
    - 4.1.1. Example: CMD245C4 shall be marked as CM245
  - 4.2. Line 2: Lot number
  - 4.3. Line 3: Date code - Last 2 digits of the year of manufacture followed by a 2-digit week code
5. Alternate pin #1 identifier is a single square pad
6. Alternate die paddle may have chamfered corners

### Recommended PCB Land Pattern

Qorvo recommends that the user develop the land pattern that will provide the best design for proper solder reflow and device attach for their specific application. Please review Qorvo Application Note AN 105 for a recommended land pattern approach.

### Recommended Solder Reflow Profile

Qorvo recommends screen printing with belt furnace reflow to ensure proper solder reflow and device attach. Please review Qorvo Application Note AN 102 for a recommended solder reflow profile.

## Pin Description

### Pin Diagram

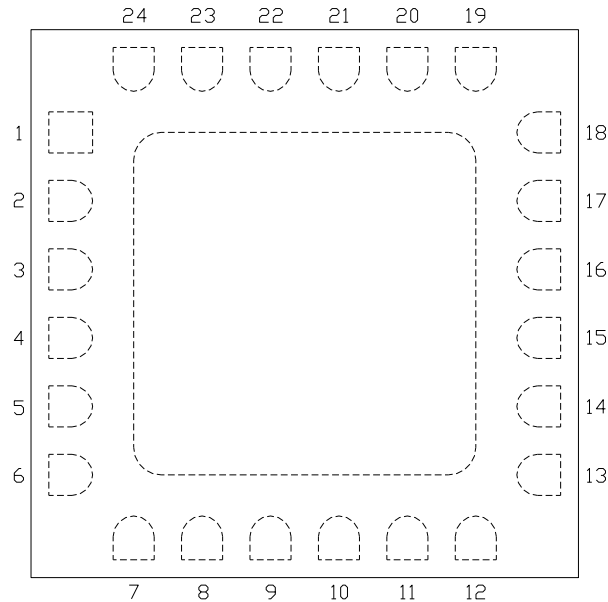

### Functional Description

Pad	Function	Description	Schematic
1, 2, 6 - 8, 10 - 14, 18 - 22, 24	N/C	No connection required These pins may be connected to RF / DC ground	
3, 5, 15, 17 and die paddle	Ground	Connect to RF / DC ground	
4	RF in	DC coupled and 50 ohm matched	
23	V <sub>dd</sub>	Power supply voltage Decoupling and bypass caps required	
16	RF out	DC blocked and 50 ohm matched	
9	V <sub>gg</sub>	Power supply voltage Decoupling and bypass caps required	

## Applications Information

### Application Circuit

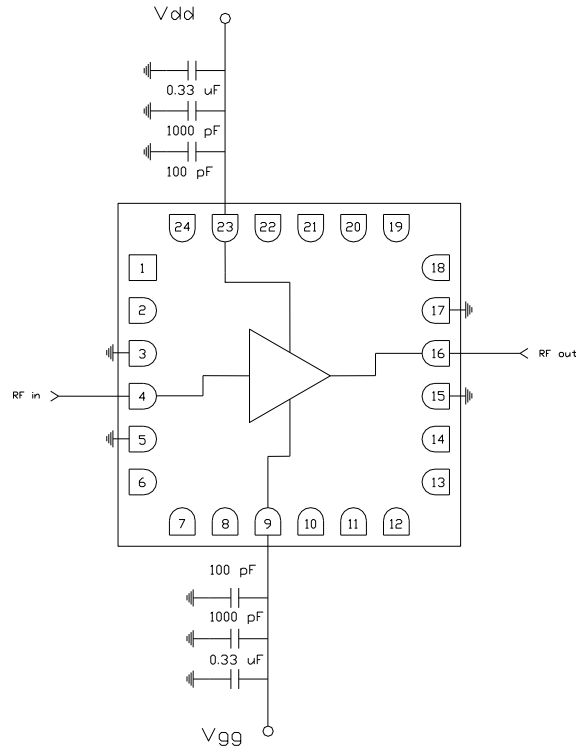

### Biasing and Operation

The CMD245C4 is biased with a positive drain supply and positive gate supply. Performance is optimized when the drain voltage is set to +5.0 V. The recommended gate voltage is +3.0 V.

Turn ON procedure:

1. Apply drain voltage  $V_{dd}$  and set to +5 V
2. Apply gate voltage  $V_{gg}$  and set to +3 V

Turn OFF procedure:

1. Turn off gate voltage  $V_{gg}$
2. Turn off drain voltage  $V_{dd}$

RF power can be applied at any time.

**GaAs MMIC devices are susceptible to damage from Electrostatic Discharge. Proper precautions should be observed during handling, assembly and test.**

## Applications Information

### Evaluation Board

The circuit board shown has been developed for optimized assembly at Qorvo. A sufficient number of via holes should be used to connect the top and bottom ground planes. As surface mount processes vary, careful process development is recommended.

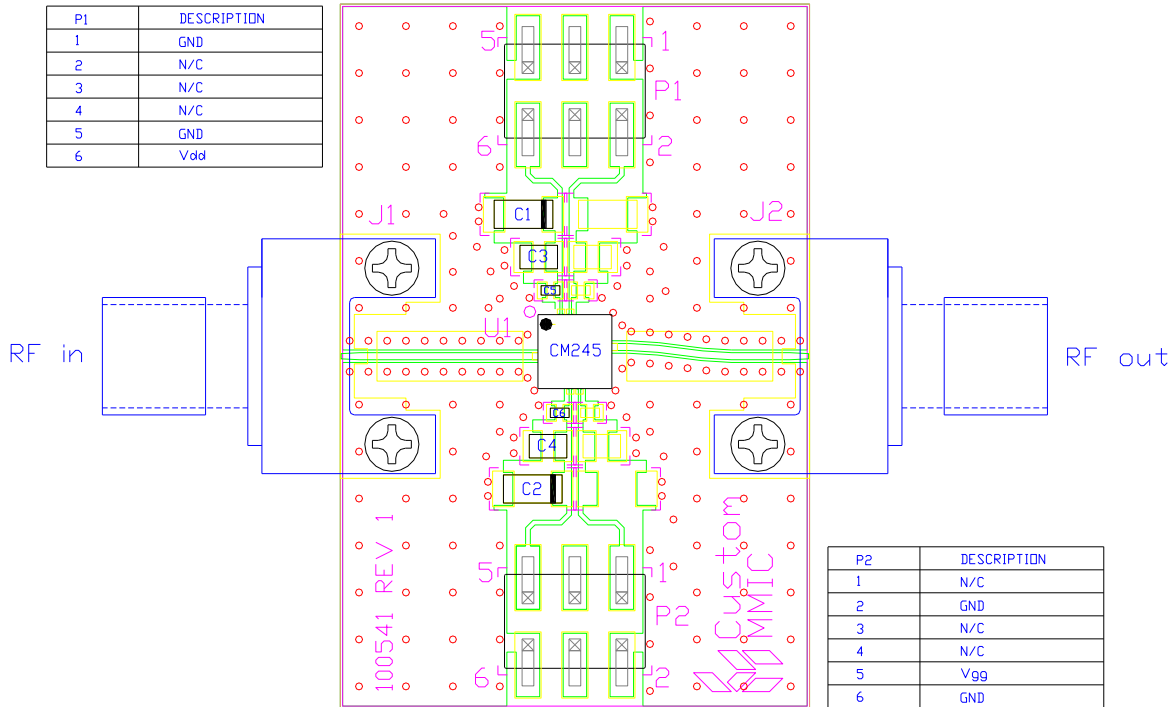

### Bill of Material

Designator	Value	Description
J1, J2		SMA End Launch Connector
P1, P2		6 Pin Header
C1, C2	0.33 $\mu$ F	Capacitor, Tantalum
C3, C4	1000 pF	Capacitor, 0603
C5, C6	100 pF	Capacitor, 0402
U1		CMD245C4 Low Phase Noise Amplifier
PCB		100541 Evaluation PCB

## Handling Precautions

Parameter	Rating	Standard
ESD – Human Body Model (HBM)	Class 1A	ESDA / JEDEC JS-001-2012
ESD – Charged Device Model (CDM)	Class C2a	ESDA / JEDEC JS-001-2012
MSL – Moisture Sensitivity Level	Level 1	IPC/JEDEC J-STD-020



Caution!  
ESD-Sensitive Device

## RoHS Compliance

This part is compliant with 2011/65/EU RoHS directive (Restrictions on the Use of Certain Hazardous Substances in Electrical and Electronic Equipment) as amended by Directive 2015/863/EU.

This product also has the following attributes:

- Lead Free
- Halogen Free (Chlorine, Bromine)
- Antimony Free
- TBBP-A (C<sub>15</sub>H<sub>12</sub>Br<sub>4</sub>O<sub>2</sub>) Free
- PFSO Free
- SVHC Free

## Contact Information

For the latest specifications, additional product information, worldwide sales and distribution locations:

**Web:** [www.qorvo.com](http://www.qorvo.com)

**Tel:** 1-844-890-8163

**Email:** [customer.support@qorvo.com](mailto:customer.support@qorvo.com)

## Important Notice

The information contained in this Data Sheet and any associated documents (“Data Sheet Information”) is believed to be reliable; however, Qorvo makes no warranties regarding the Data Sheet Information and assumes no responsibility or liability whatsoever for the use of said information. All Data Sheet Information is subject to change without notice. Customers should obtain and verify the latest relevant Data Sheet Information before placing orders for Qorvo® products. Data Sheet Information or the use thereof does not grant, explicitly, implicitly or otherwise any rights or licenses to any third party with respect to patents or any other intellectual property whether with regard to such Data Sheet Information itself or anything described by such information.

DATA SHEET INFORMATION DOES NOT CONSTITUTE A WARRANTY WITH RESPECT TO THE PRODUCTS DESCRIBED HEREIN, AND QORVO HEREBY DISCLAIMS ANY AND ALL WARRANTIES WITH RESPECT TO SUCH PRODUCTS WHETHER EXPRESS OR IMPLIED BY LAW, COURSE OF DEALING, COURSE OF PERFORMANCE, USAGE OF TRADE OR OTHERWISE, INCLUDING THE IMPLIED WARRANTIES OF MERCHANTABILITY AND FITNESS FOR A PARTICULAR PURPOSE. Without limiting the generality of the foregoing, Qorvo® products are not warranted or authorized for use as critical components in medical, life-saving, or life-sustaining applications, or other applications where a failure would reasonably be expected to cause severe personal injury or death. Applications described in the Data Sheet Information are for illustrative purposes only. Customers are responsible for validating that a particular product described in the Data Sheet Information is suitable for use in a particular application.

© 2022 Qorvo US, Inc. All rights reserved. This document is subject to copyright laws in various jurisdictions worldwide and may not be reproduced or distributed, in whole or in part, without the express written consent of Qorvo US, Inc. | QORVO® is a registered trademark of Qorvo US, Inc.

## Looking for pricing, stock, or lifecycle information?

Click below to explore more details on WIN SOURCE:

 [View CMD245C4 on WIN SOURCE](#)

 [Qorvo US Inc. Information](#)

## Optimize Your Supply Chain with WIN SOURCE Solutions

-  Global Sourcing Solution
-  Obsolete Management
-  Cost Control Management
-  Shortage Management
-  Alternative Solution
-  Excess Inventory Management