



**THE DATASHEET OF
QPA2935**





QPA2935

2 Watt S-Band GaN Driver Amplifier

Product Overview

Qorvo's QPA2935 is a MMIC power amplifier fabricated using Qorvo's QGaN25 0.25 um GaN on SiC production process. Covering 2.7–3.5 GHz, the QPA2935 typically provides 33 dBm of saturated output power and 18 dB of large-signal gain while achieving greater than 52 % power-added efficiency.

The QPA2935 can support a variety of operating conditions to best support system requirements. With good thermal properties, it can support a range of bias voltages. The QPA2935 is matched to 50 ohms with integrated DC blocking caps on both I/O ports..

The QPA2935 is packaged in a plastic overmolded 4x4 mm package. The QPA2935 is 100% DC and RF tested to ensure compliance to electrical specifications.

Lead free and RoHS compliant.

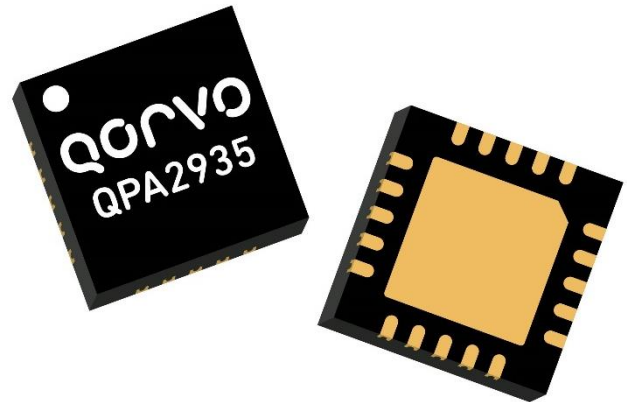

Key Features

- Frequency Range: 2.7 – 3.5 GHz
- P_{SAT} : 33 dBm ($P_{IN} = 15$ dBm)
- PAE: > 52 % ($P_{IN} = 15$ dBm)
- Small Signal Gain: 28.4 dB
- Bias: $V_D = 25$ V, $I_{DQ} = 29$ mA
- Package Dimensions: 4.00 x 4.00 x 0.85 mm

Performance is typical across frequency. Please reference electrical specification table and data plots for more details.

Functional Block Diagram

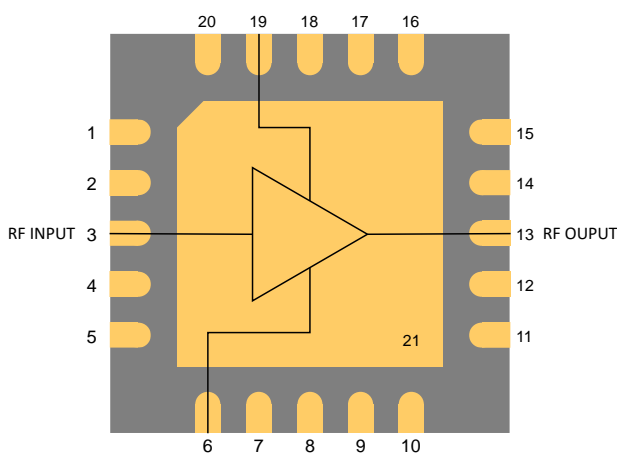

Top View

Applications

- Electronic Warfare
- Civilian and Military Radar

Ordering Information

Part No.	Description
QPA2935	2 Watt S-Band GaN Driver Amplifier
QPA2935EVB	Evaluation Board for QPA2935
QPA2935TR7	250 pcs. on 7 inch reel

Absolute Maximum Ratings

Parameter	Value / Range
Drain Voltage (V_D)	40 V
Gate Voltage Range (V_G)	-4 V to +1 V
Drain Current (I_D)	385 mA
Gate Current (I_G)	See plot page 17
P_{DISS} (under drive), 85 °C	11.5 W
Input Power, $Z_L=50 \Omega$, $V_D=25$ V, $I_{DQ}=29$ mA, CW, 85 °C	21 dBm
Input Power, Output VSWR=3:1, $V_D=25$ V, $I_{DQ}=29$ mA, CW, 85 °C	21 dBm
Soldering Temperature	260 °C
Storage Temperature	-55 to +125 °C

Operation of this device outside the parameter ranges given above may cause permanent damage. These are stress ratings only, and functional operation of the device at these conditions is not implied.

Recommended Operating Conditions

Parameter	Min	Typ	Max	Unit
Drain Voltage (V_D)		25		V
Drain Current (I_{DQ})		29		mA
Operating Temperature	-40	25	85	°C

Electrical specifications are measured at specified test conditions. Specifications are not guaranteed over all recommended operating conditions.

Electrical Specifications

Parameter	Min	Typ	Max	Units
Operational Frequency	2.7		3.5	GHz
Output Power ($P_{IN}=15$ dBm)		34.3		dBm
Power Added Eff. ($P_{IN}=15$ dBm)		54.8		%
Small Signal Gain		28.4		dB
Input Return Loss		15		dB
Output Return Loss		7		dB
Second Harmonic Level ($P_{IN}=15$ dBm, 3.1 GHz)		-27		dBc
Third Harmonic Level ($P_{IN}=15$ dBm, 3.1 GHz)		-43		dBc
P_{OUT} Temp. Coeff. (85 °C to -40 °C, $P_{IN} = 15$ dBm)		-0.002		dB/°C
Sm. Sig. Gain Temp. Coefficient (85 °C to -40 °C)		-0.041		dB/°C
Gate Leakage Current ($V_D = +10$ V, $V_G = -3.7$ V)	-1.3			mA

Test conditions, unless otherwise noted: $V_D = 25$ V, $I_{DQ} = 29$ mA, $T = +25$ °C, CW

Performance Plots – Large Signal

Test conditions, unless otherwise noted: $V_D = 25\text{ V}$, $I_{DQ} = 29\text{ mA}$, $T = +25\text{ }^\circ\text{C}$, $P_{IN} = 15\text{ dBm}$, CW

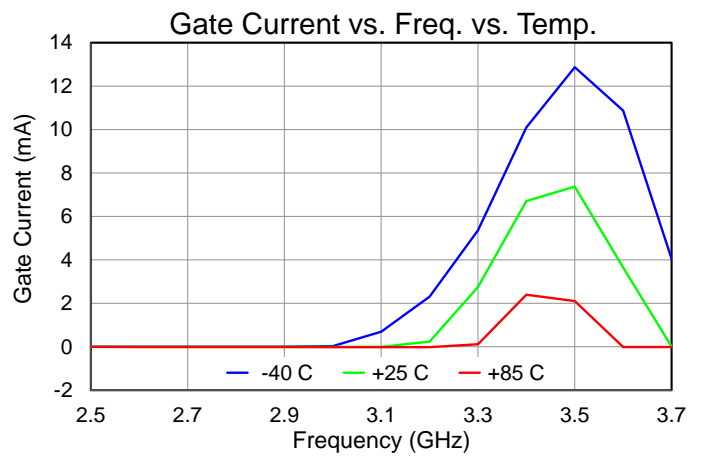
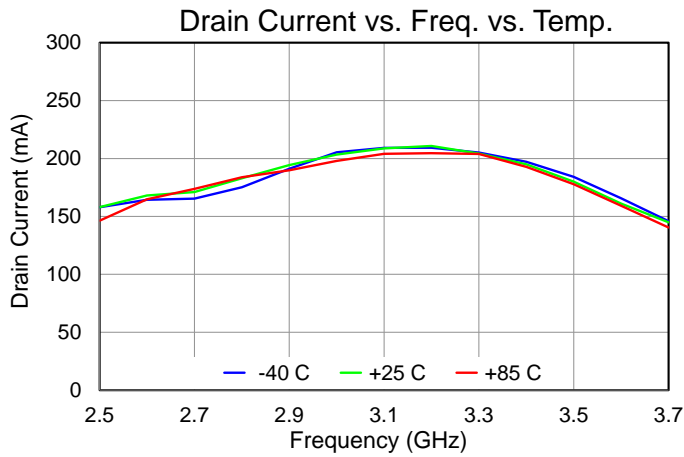
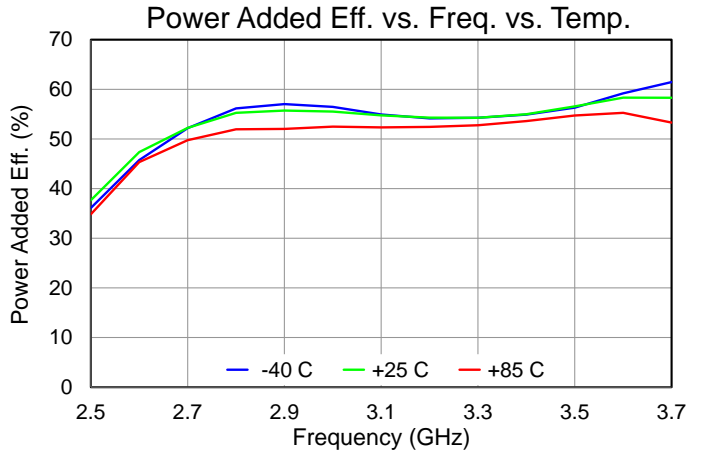
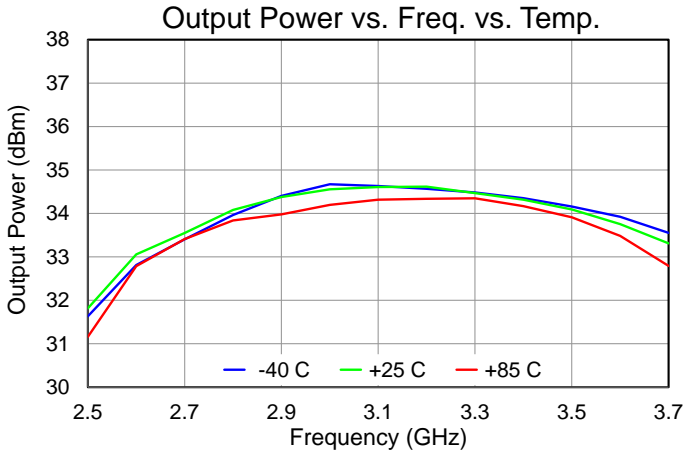

Performance Plots – Large Signal

Test conditions, unless otherwise noted: $V_D = 25\text{ V}$, $I_{DQ} = 29\text{ mA}$, $T = +25\text{ }^\circ\text{C}$, $P_{IN} = 15\text{ dBm}$, CW

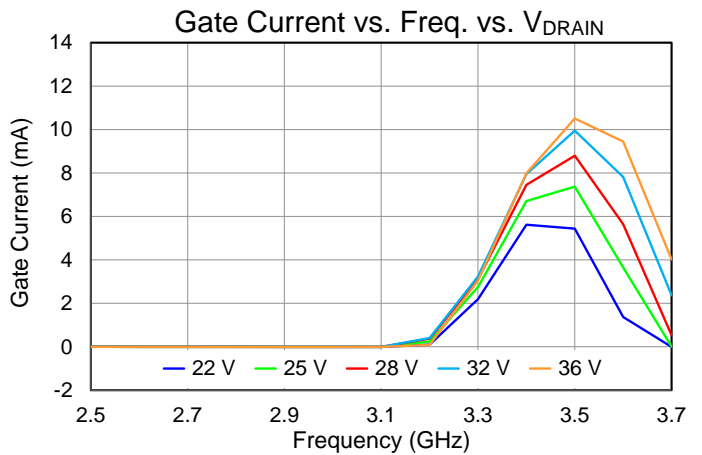
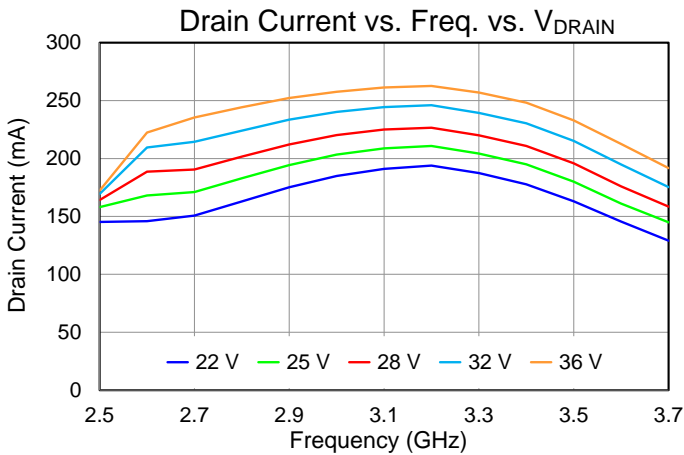
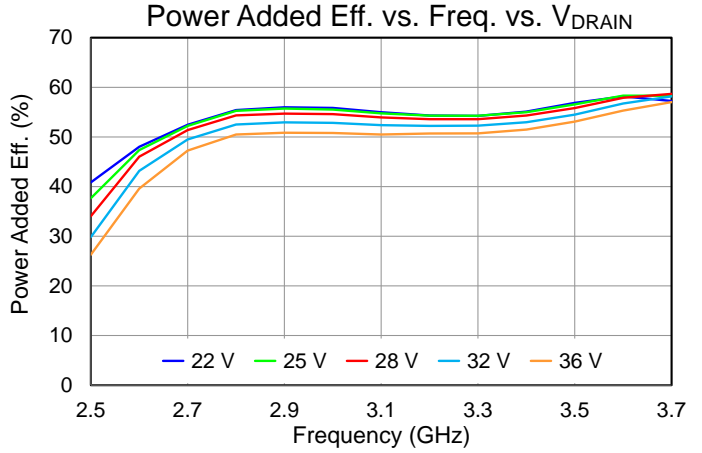
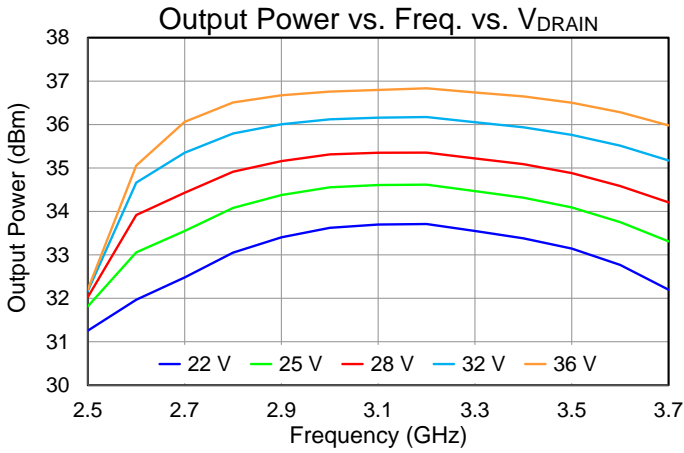

Performance Plots – Large Signal

Test conditions, unless otherwise noted: $V_D = 25\text{ V}$, $I_{DQ} = 29\text{ mA}$, $T = +25\text{ }^\circ\text{C}$, $P_{IN} = 15\text{ dBm}$, CW

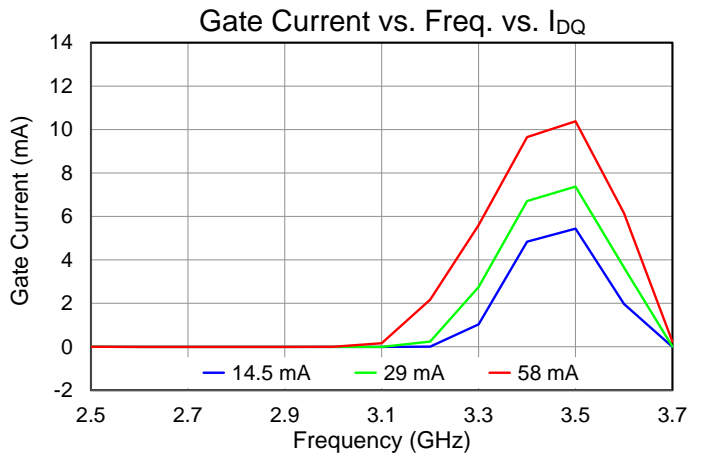
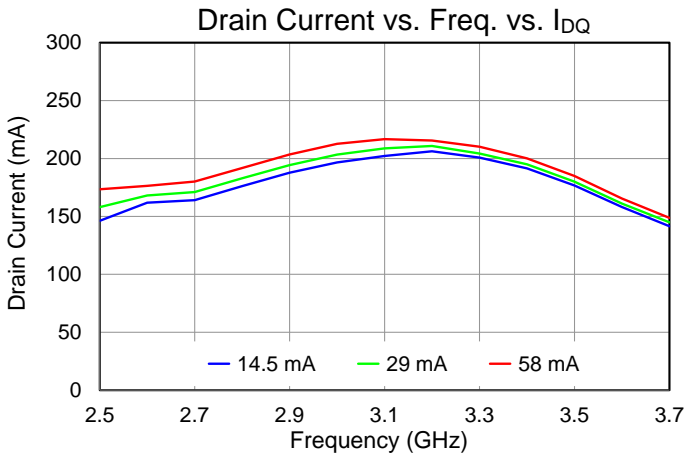
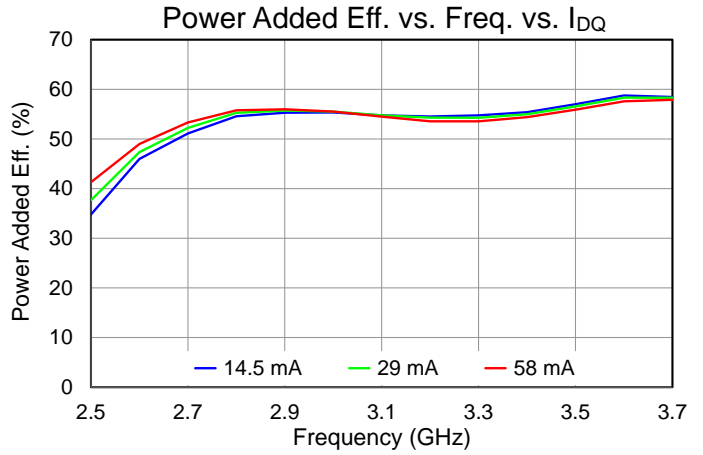
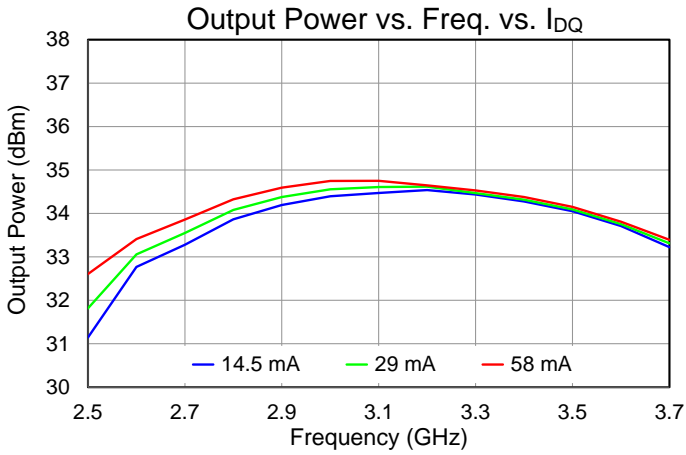

Performance Plots – Large Signal

Test conditions, unless otherwise noted: $V_D = 25\text{ V}$, $I_{DQ} = 29\text{ mA}$, $T = +25\text{ }^\circ\text{C}$, $P_{IN} = 15\text{ dBm}$, CW

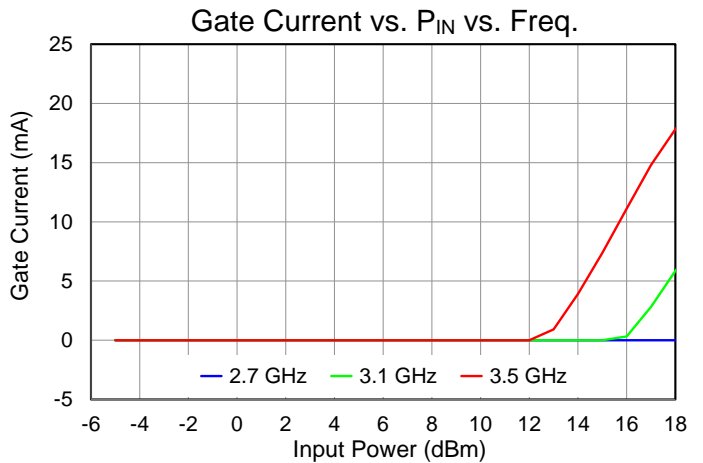
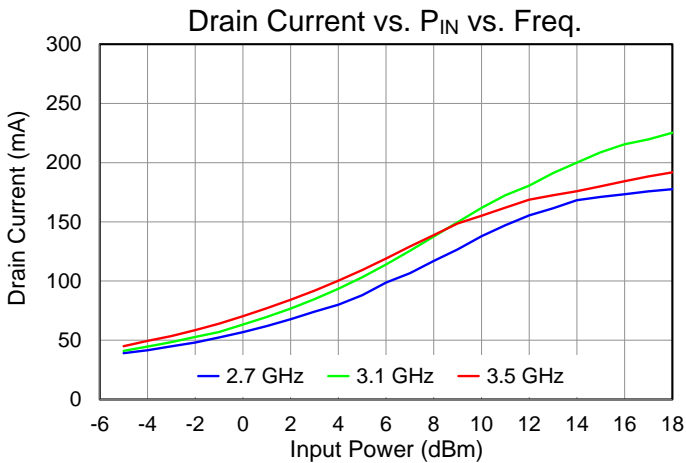
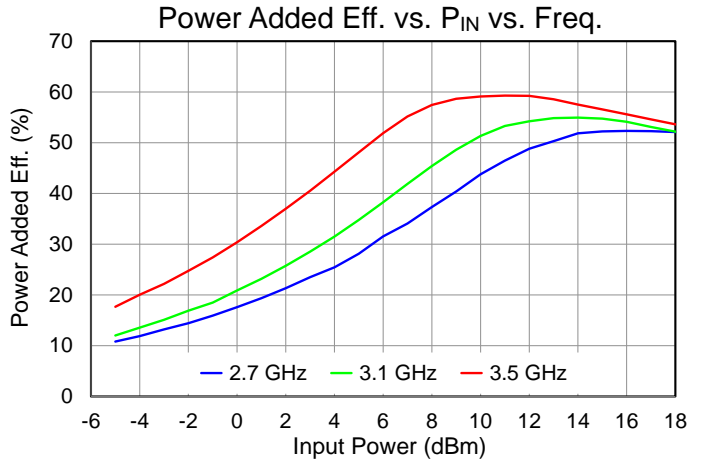
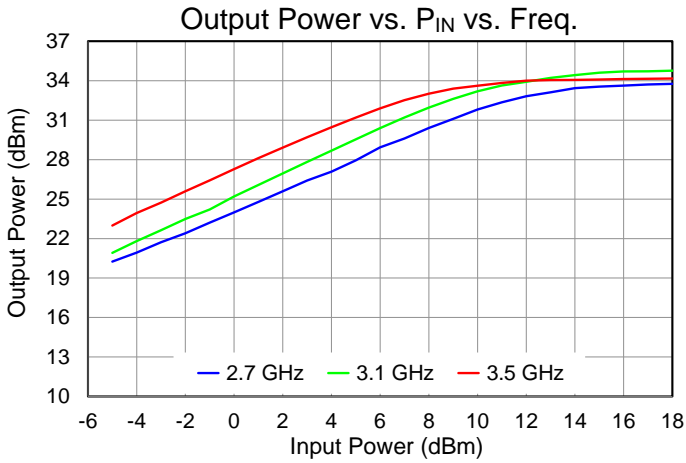

Performance Plots – Large Signal

Test conditions, unless otherwise noted: $V_D = 25\text{ V}$, $I_{DQ} = 29\text{ mA}$, $T = +25\text{ }^\circ\text{C}$, $P_{IN} = 15\text{ dBm}$, CW

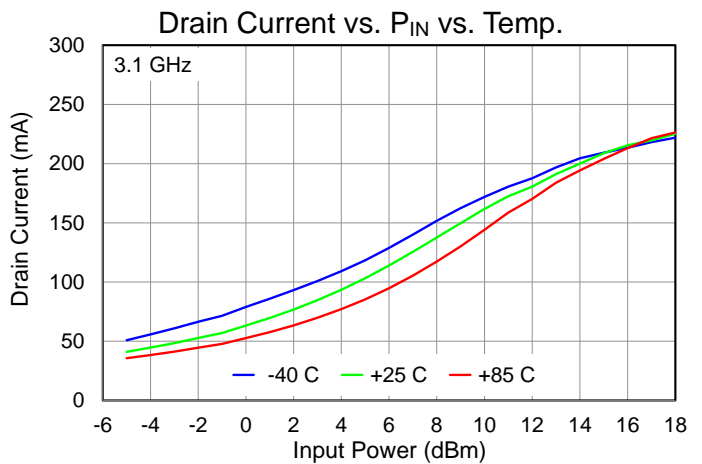
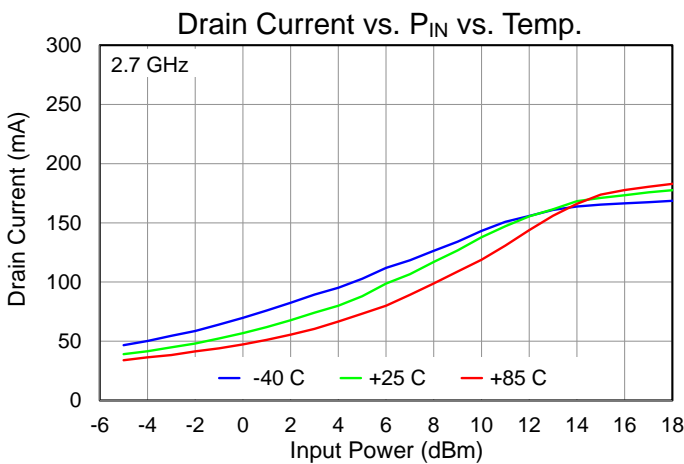
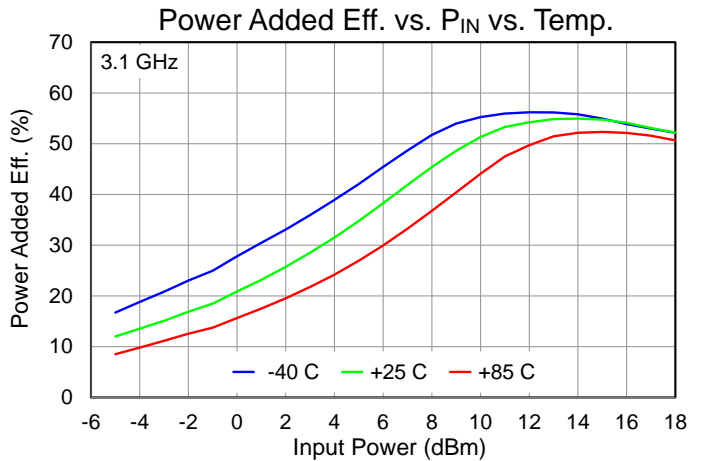
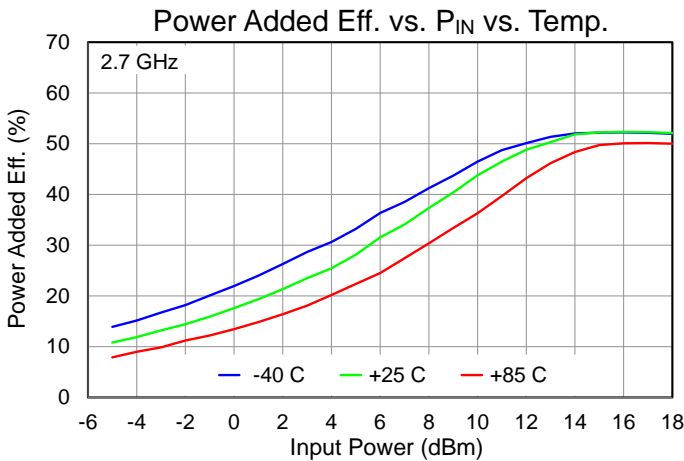
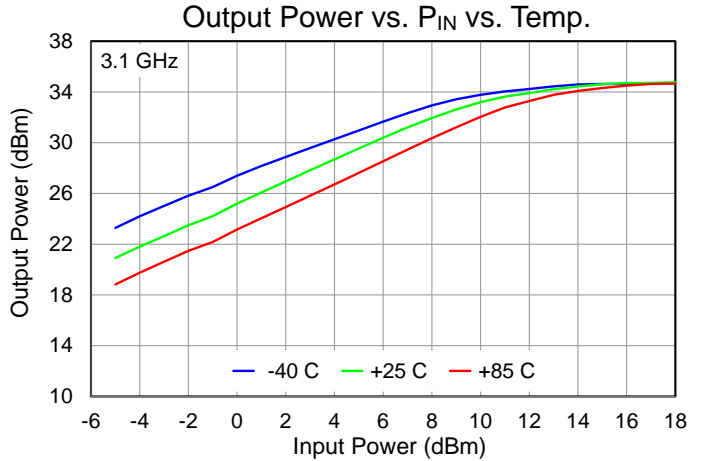
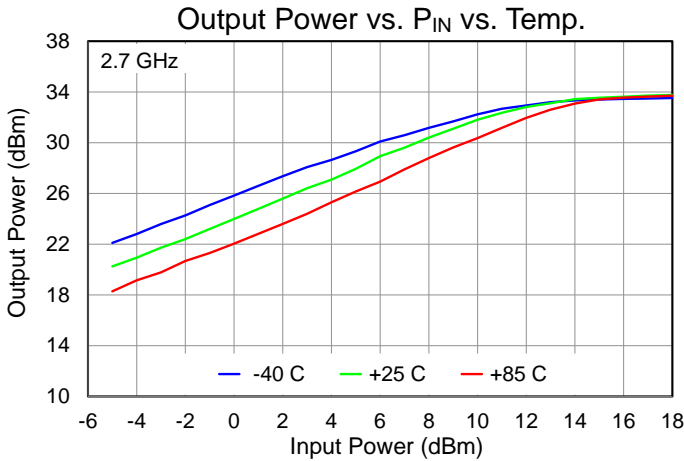

Performance Plots – Large Signal

Test conditions, unless otherwise noted: $V_D = 25\text{ V}$, $I_{DQ} = 29\text{ mA}$, $T = +25\text{ }^\circ\text{C}$, $P_{IN} = 15\text{ dBm}$, CW

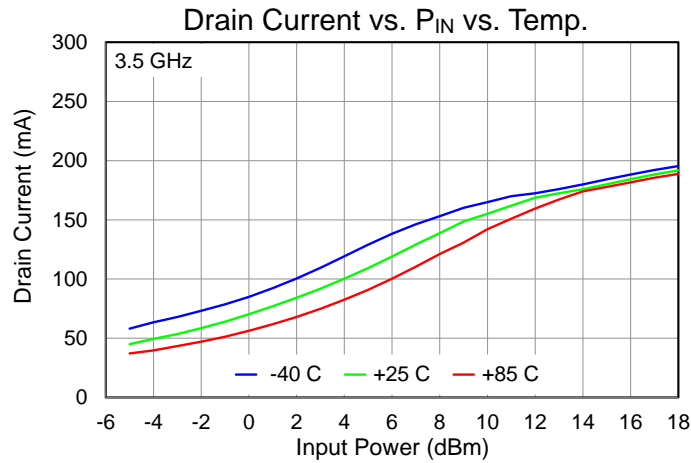
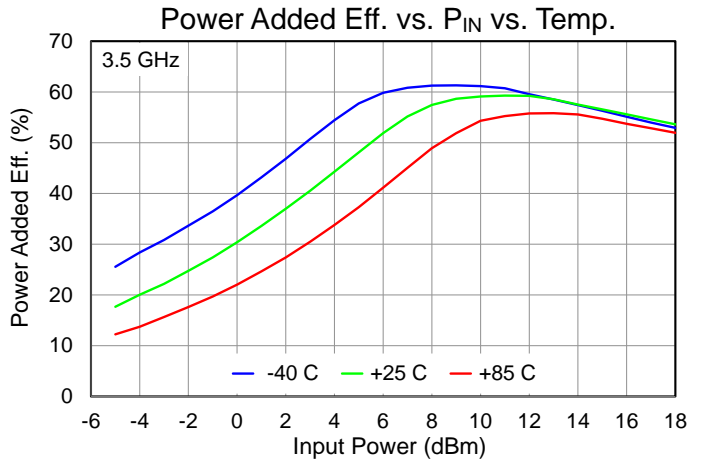
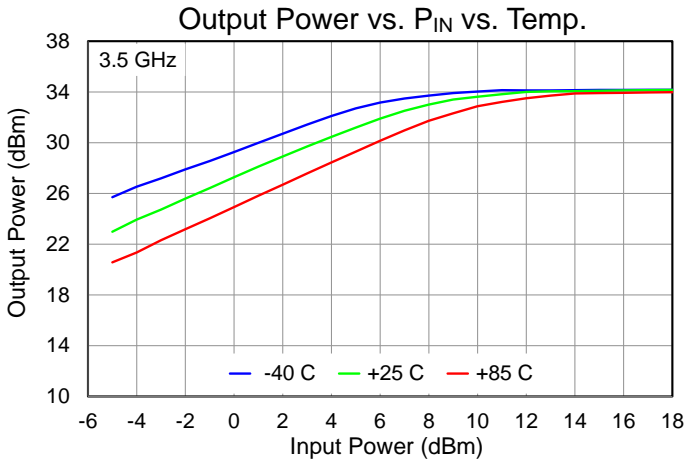

Performance Plots – Large Signal

Test conditions, unless otherwise noted: $V_D = 25\text{ V}$, $I_{DQ} = 29\text{ mA}$, $T = +25\text{ }^\circ\text{C}$, $P_{IN} = 15\text{ dBm}$, CW

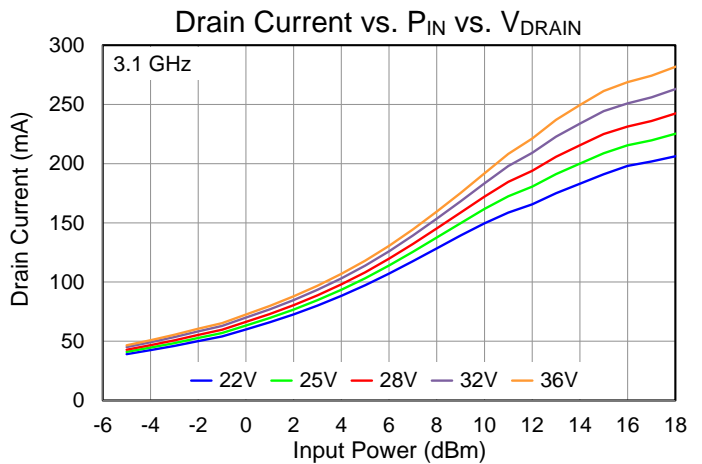
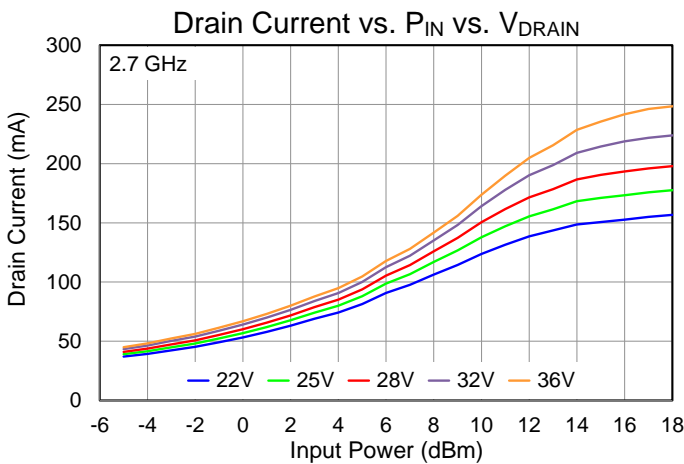
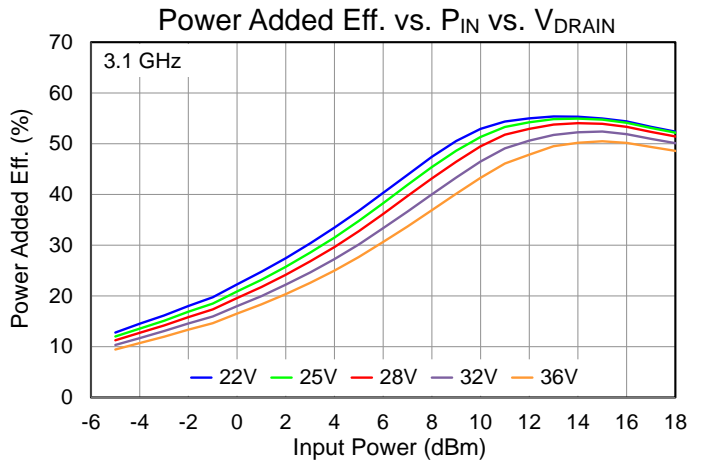
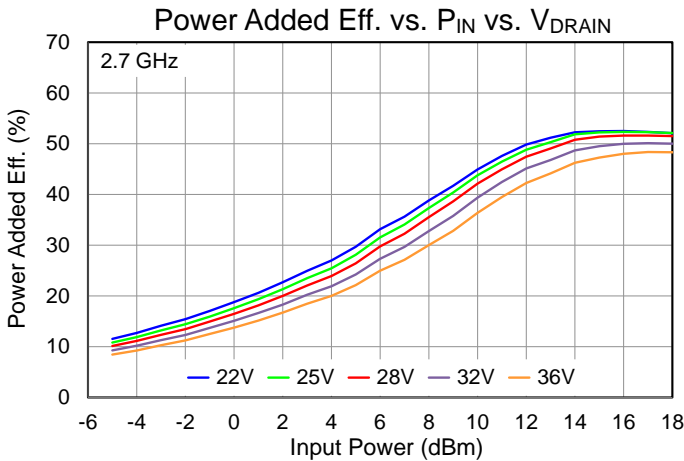
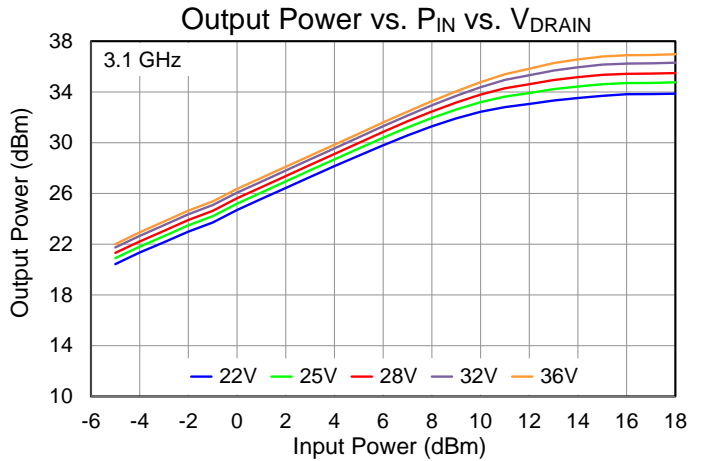
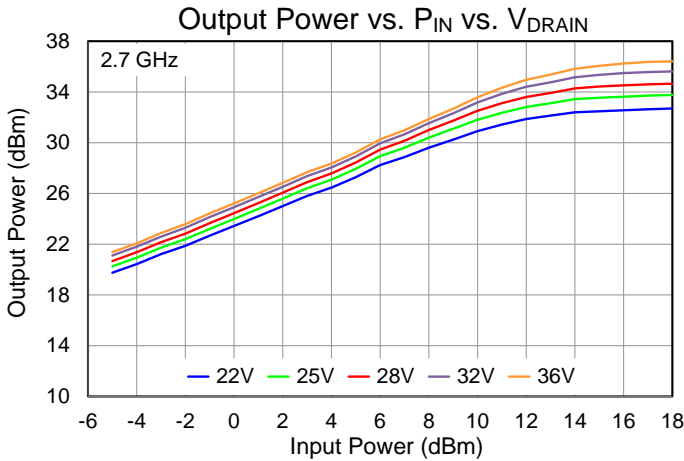

Performance Plots – Large Signal

Test conditions, unless otherwise noted: $V_D = 25\text{ V}$, $I_{DQ} = 29\text{ mA}$, $T = +25\text{ }^\circ\text{C}$, $P_{IN} = 15\text{ dBm}$, CW

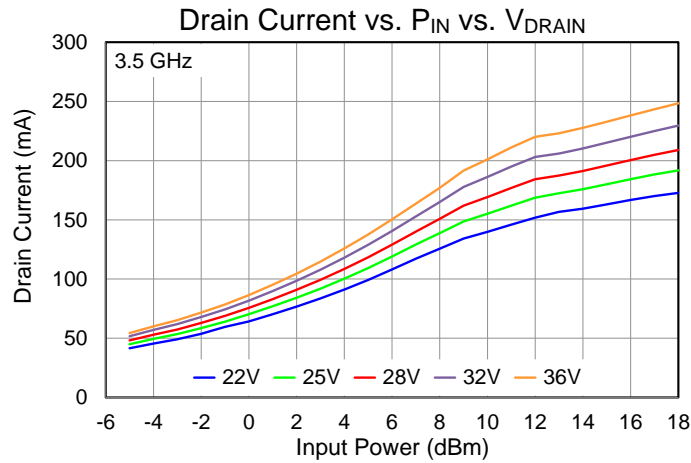
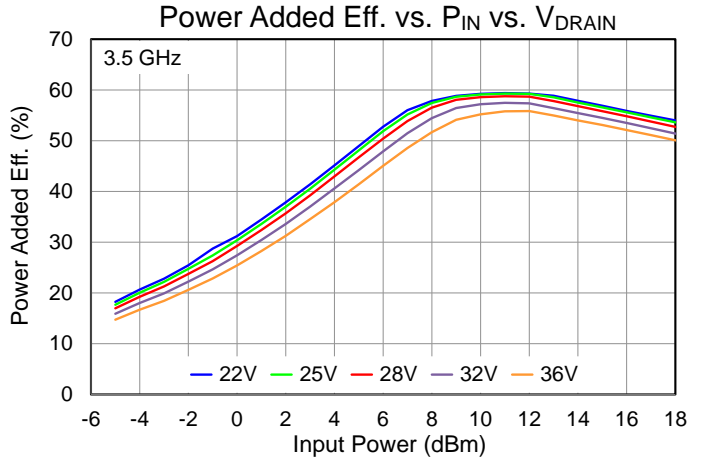
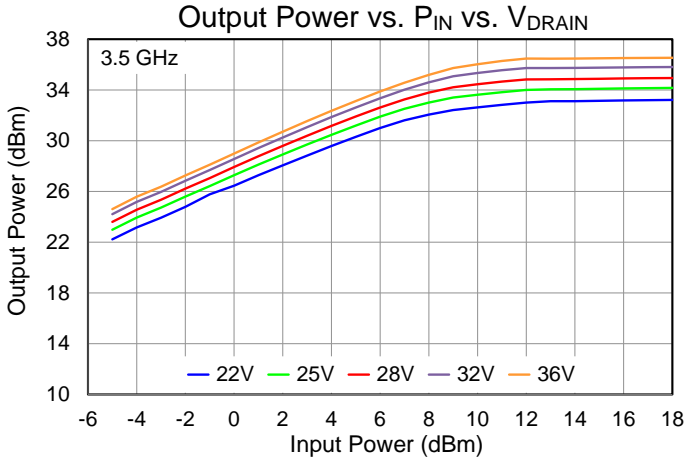

Performance Plots – Large Signal

Test conditions, unless otherwise noted: $V_D = 25\text{ V}$, $I_{DQ} = 29\text{ mA}$, $T = +25\text{ }^\circ\text{C}$, $P_{IN} = 15\text{ dBm}$, CW

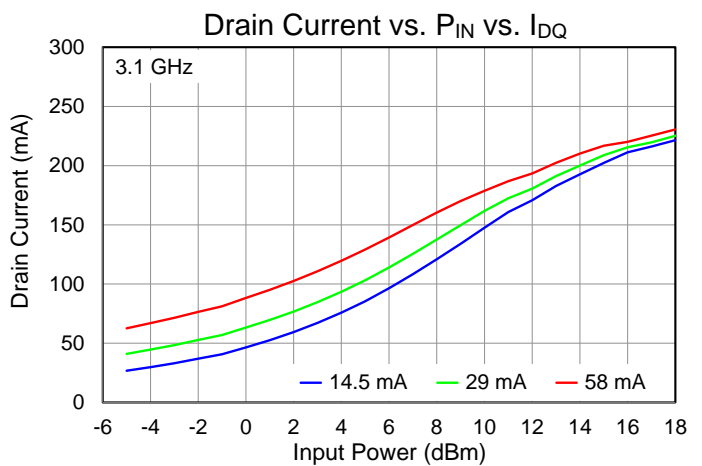
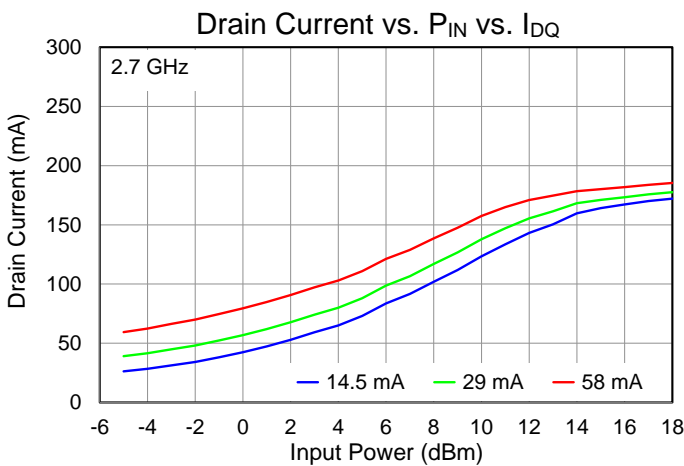
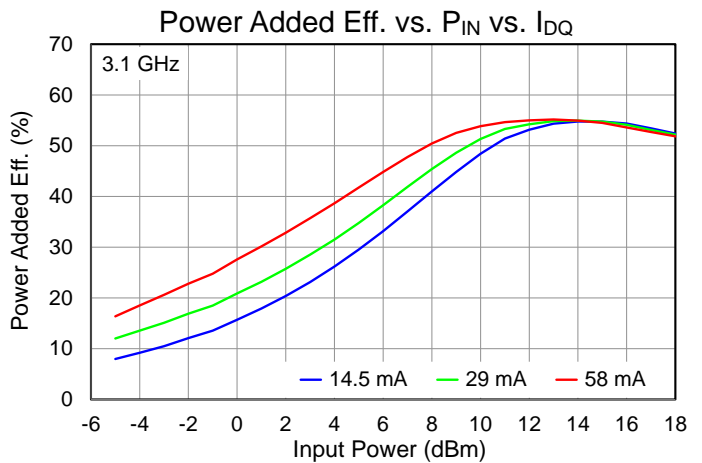
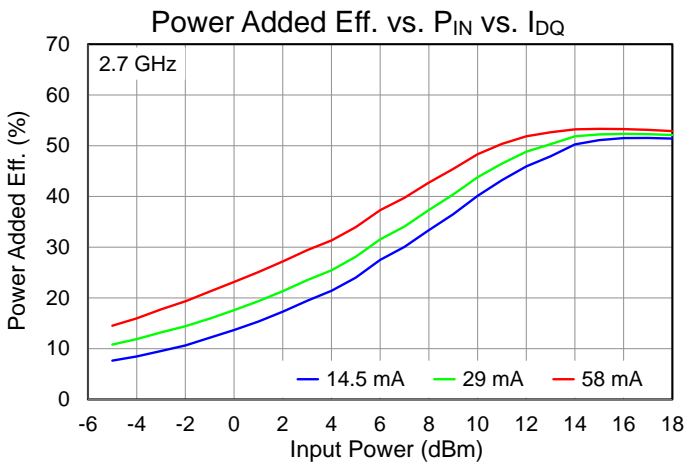
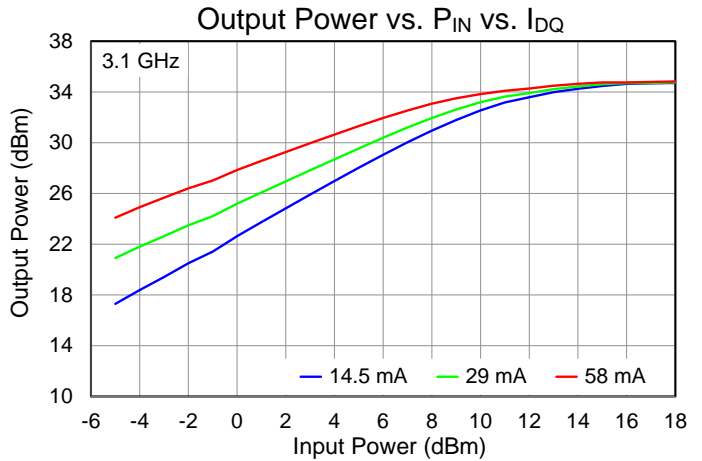
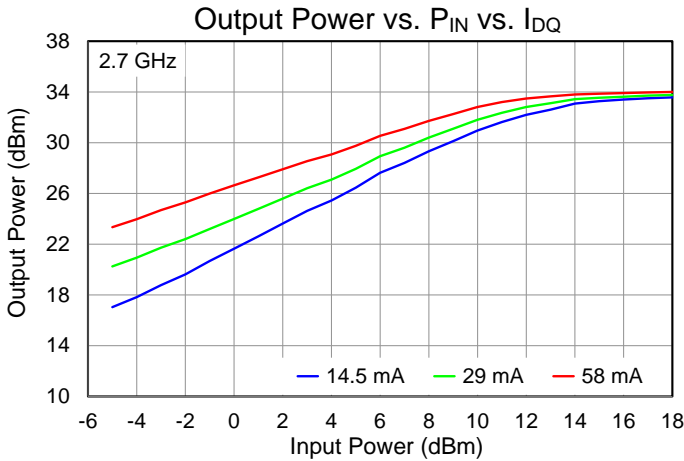

Performance Plots – Large Signal

Test conditions, unless otherwise noted: $V_D = 25\text{ V}$, $I_{DQ} = 29\text{ mA}$, $T = +25\text{ }^\circ\text{C}$, $P_{IN} = 15\text{ dBm}$, CW

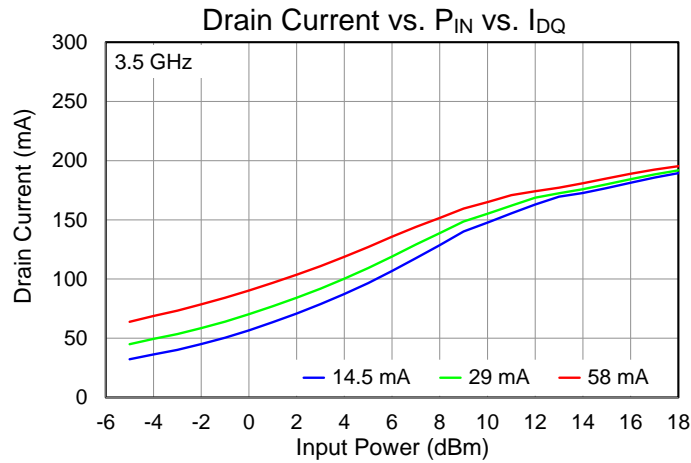
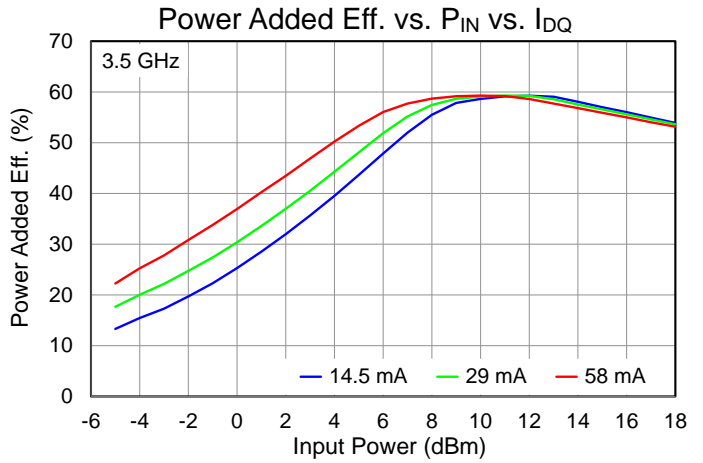
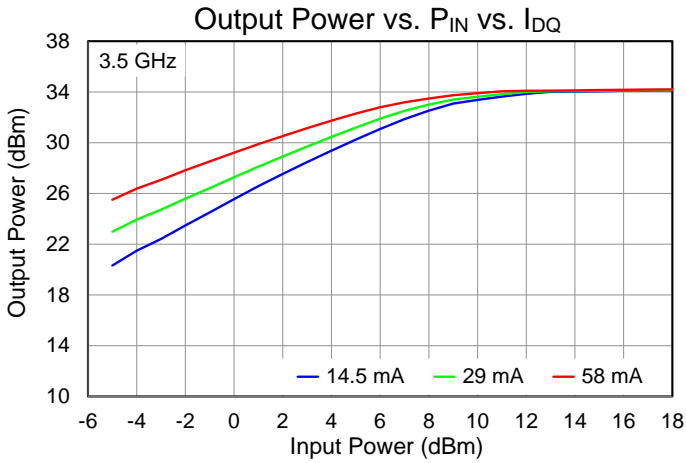

Performance Plots – Small Signal

Test conditions, unless otherwise noted: $V_D = 25\text{ V}$, $I_{DQ} = 29\text{ mA}$, $T = +25\text{ }^\circ\text{C}$, CW

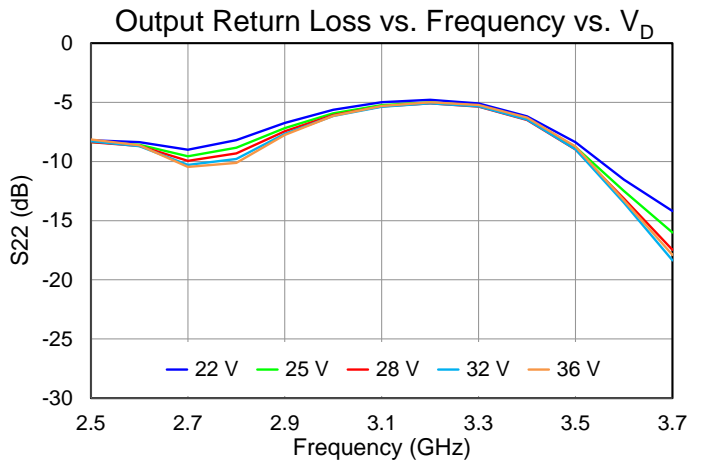
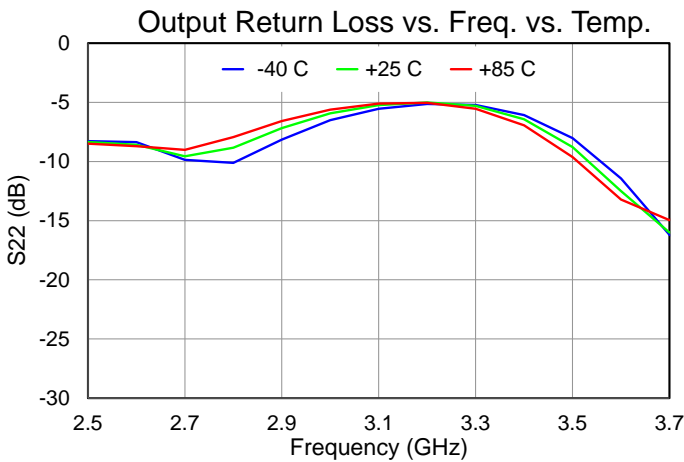
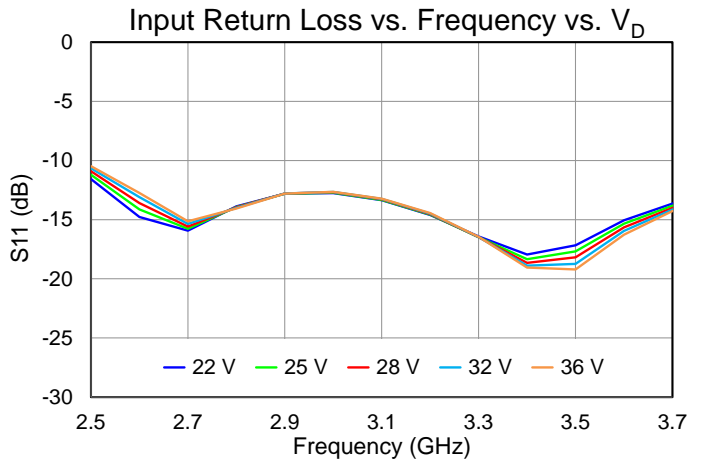
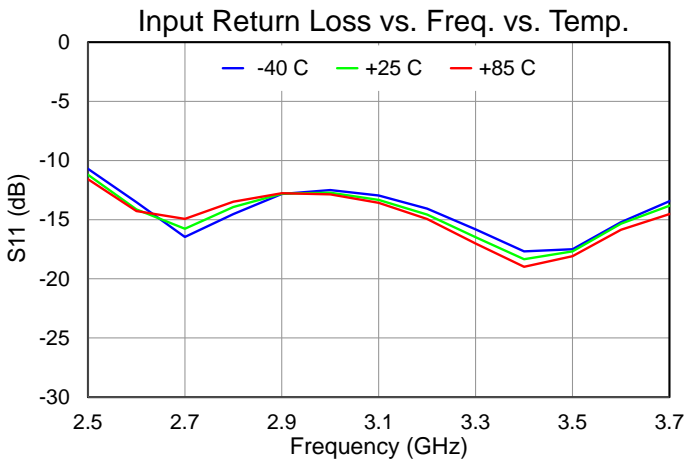
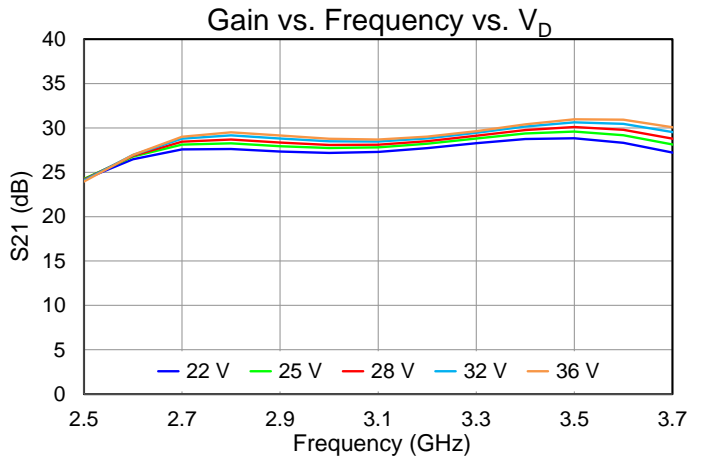
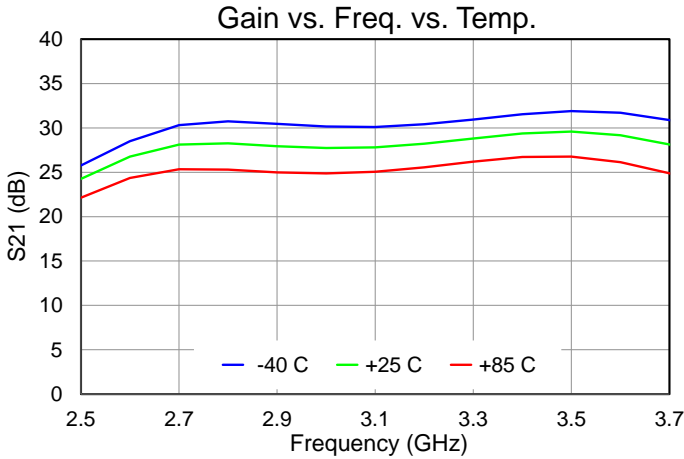

Performance Plots – Small Signal

Test conditions, unless otherwise noted: $V_D = 25\text{ V}$, $I_{DQ} = 29\text{ mA}$, $T = +25\text{ }^\circ\text{C}$, CW

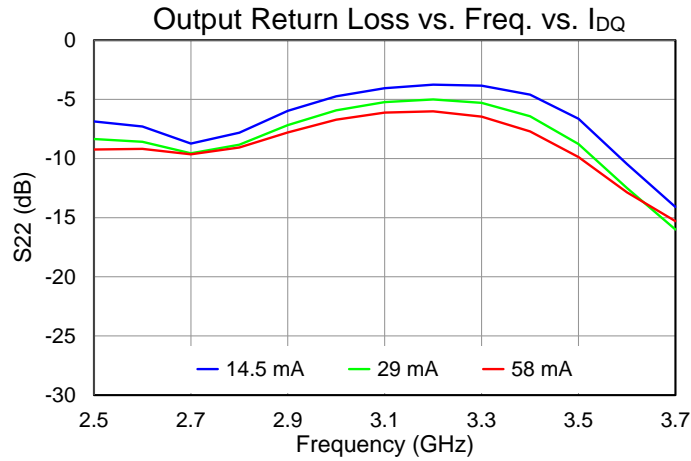
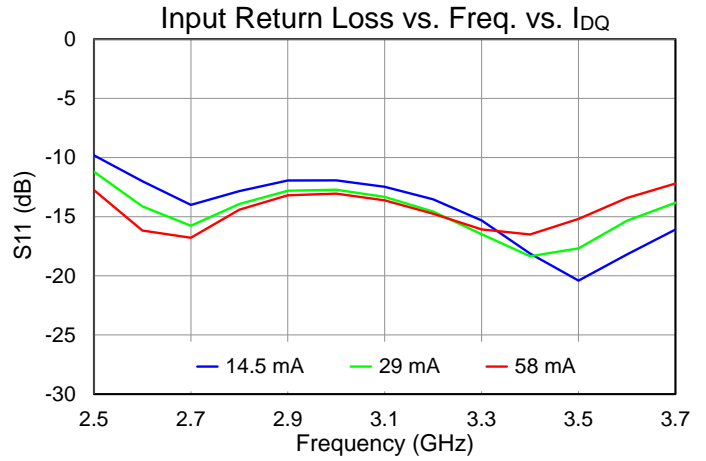
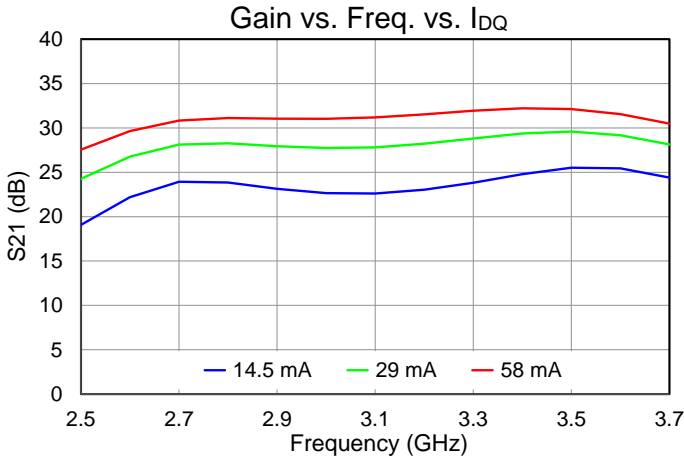

Performance Plots – Harmonics

Test conditions, unless otherwise noted: $V_D = 25\text{ V}$, $I_{DQ} = 29\text{ mA}$, $T = +25\text{ }^\circ\text{C}$, CW

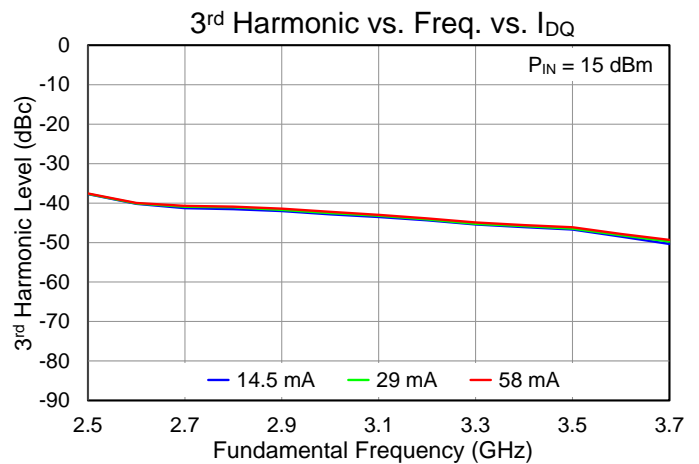
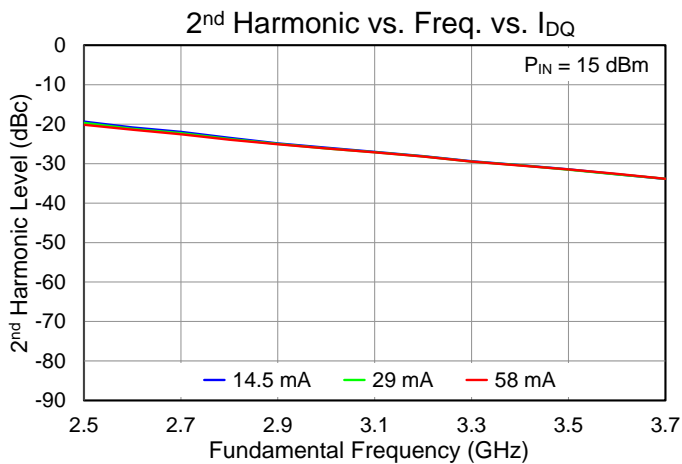
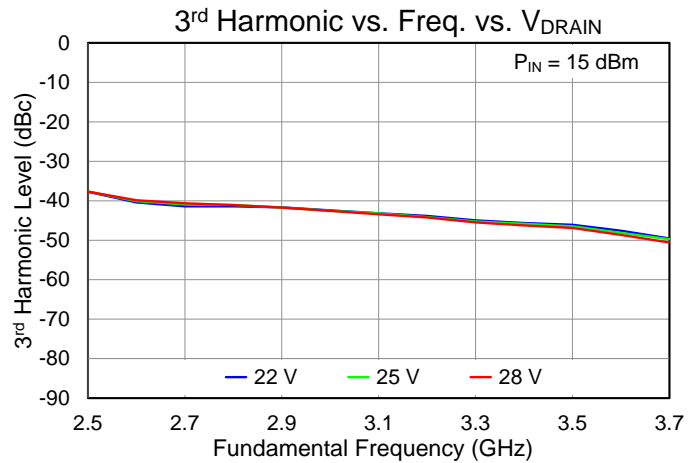
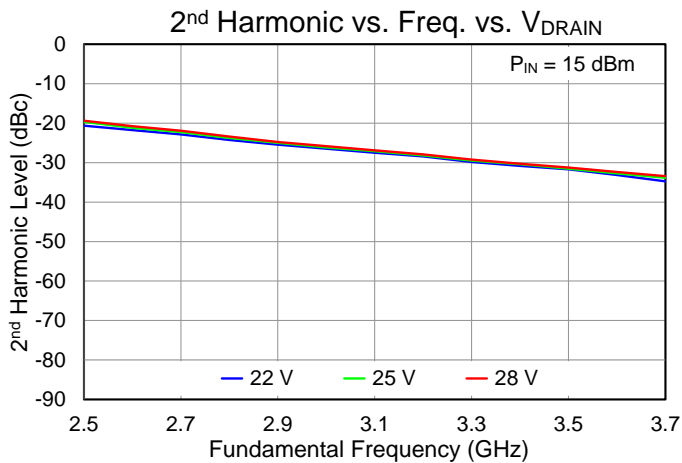
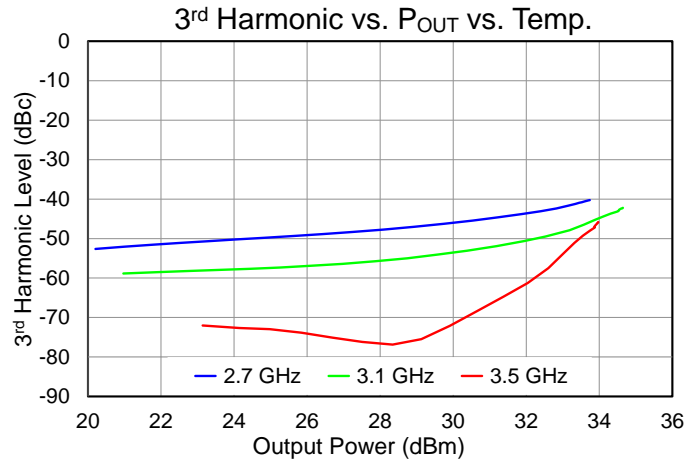
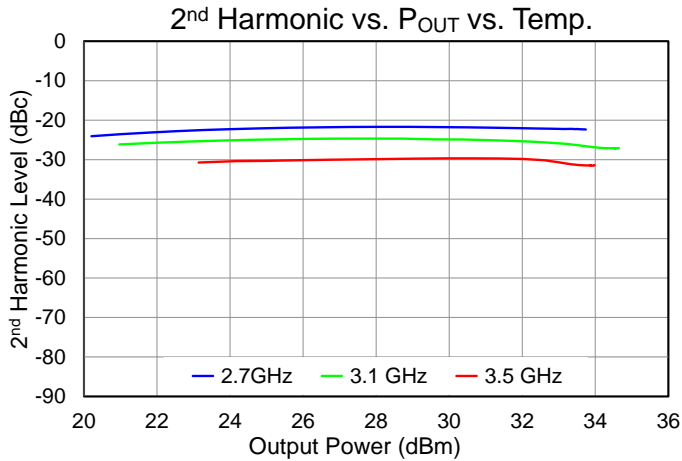

Performance Plots – Linearity

Test conditions, unless otherwise noted: $V_D = 25\text{ V}$, $I_{DQ} = 29\text{ mA}$, $T = +25\text{ }^\circ\text{C}$, CW, Tone Spacing = 10 MHz

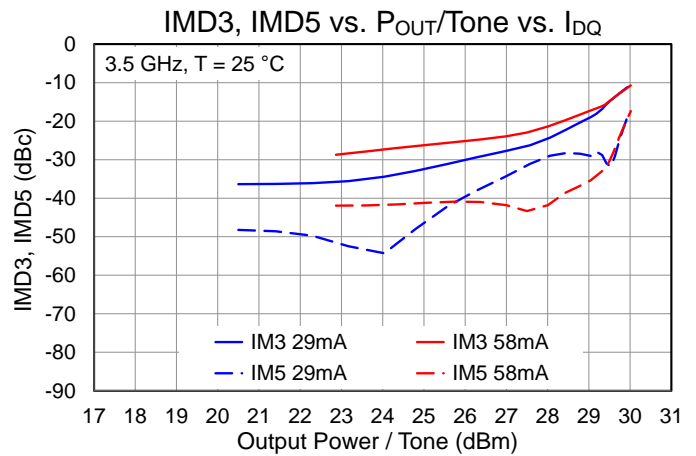
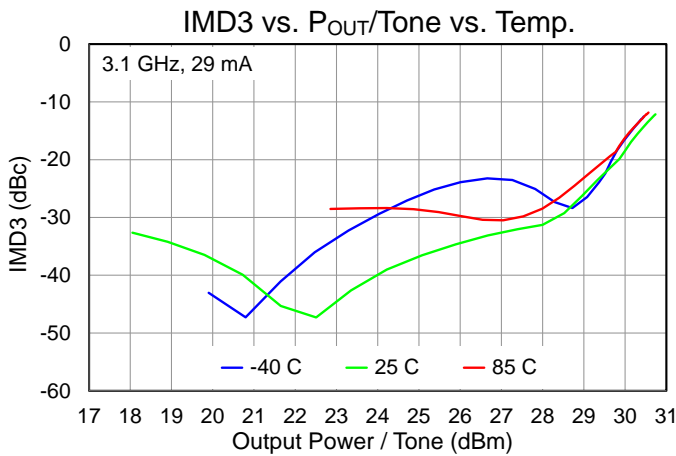
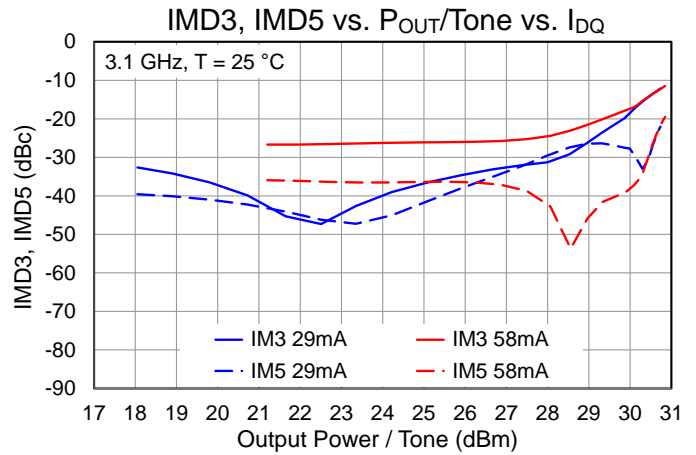
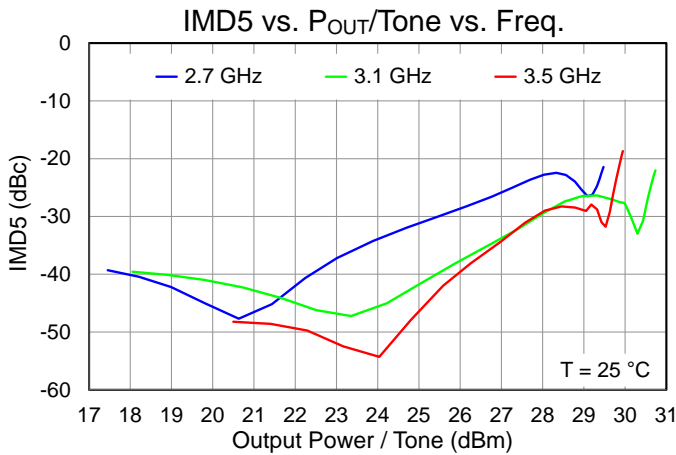
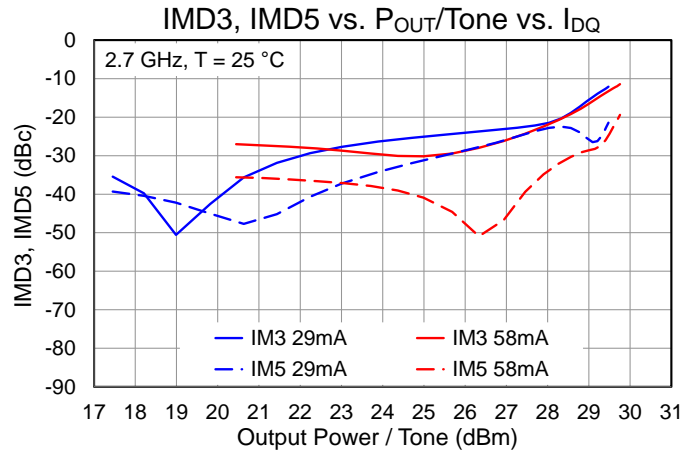
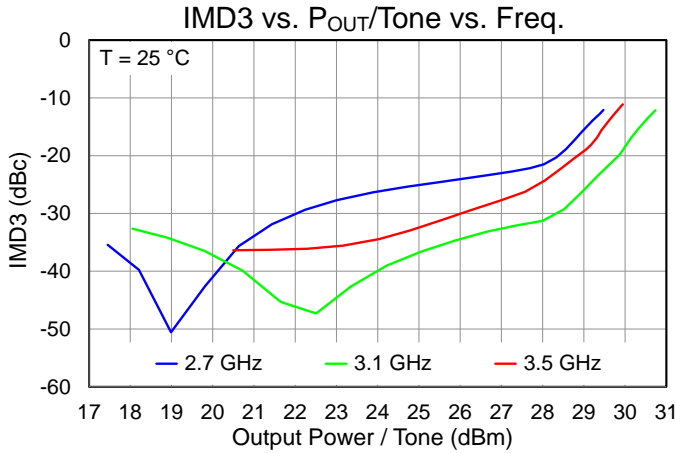

Thermal and Reliability Information

Parameter	Test Conditions	Value	Units
Thermal Resistance (θ_{JC}) ⁽¹⁾	$T_{base} = 85\text{ }^{\circ}\text{C}$, $V_D = 25\text{ V}$, $I_{DQ} = 29\text{ mA}$, $P_{DISS} = 0.725\text{ W}$ (Quiescent; no RF drive)	8.936	$^{\circ}\text{C/W}$
Channel Temperature, T_{CH} (Quiescent) ⁽²⁾		91.5	$^{\circ}\text{C}$
Thermal Resistance (θ_{JC}) ⁽¹⁾	$T_{base} = 85\text{ }^{\circ}\text{C}$, $V_D = 25\text{ V}$, $I_{DQ} = 29\text{ mA}$, $\text{Freq} = 3.1\text{ GHz}$, $I_{D_Drive} = 204\text{ mA}$, $P_{IN} = 15\text{ dBm}$, $P_{OUT} = 34.3\text{ dBm}$, $P_{DISS} = 2.43\text{ W}$	9.189	$^{\circ}\text{C/W}$
Channel Temperature, T_{CH} (w/ RF drive) ⁽²⁾		107.3	$^{\circ}\text{C}$

Notes:

1. Thermal resistance determined to the back of package, T_{base} (85 $^{\circ}\text{C}$)
2. T_{CH} values are IR Scan equivalent temperatures. Refer to the following document: [GaN Device Channel Temperature, Thermal Resistance, and Reliability Estimates](#)

Dissipated Power and Maximum Gate Current

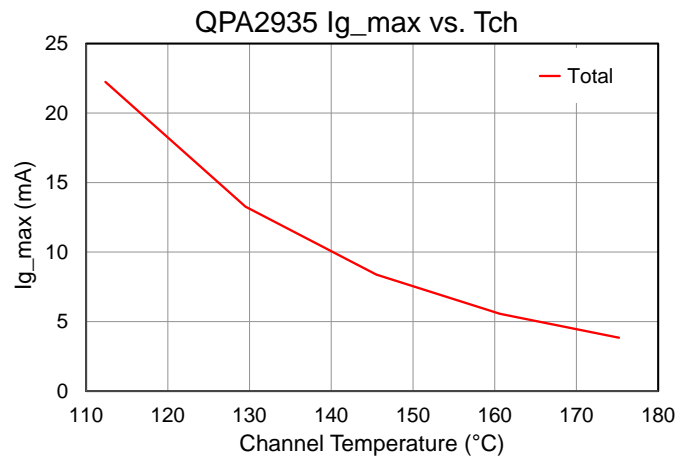
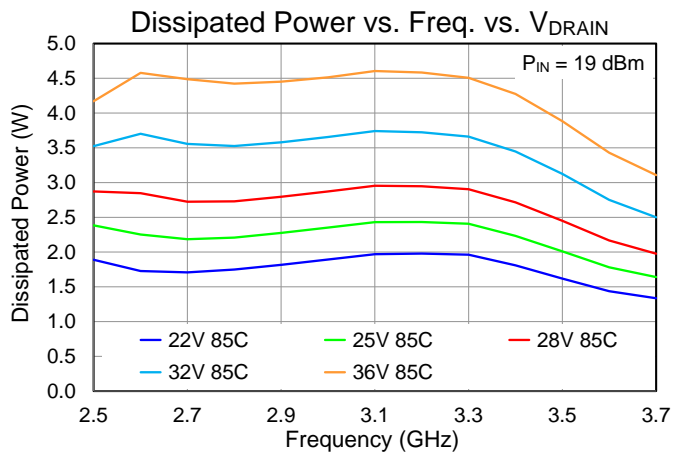

Test conditions, unless otherwise noted: $V_D = 25\text{ V}$, $I_{DQ} = 29\text{ mA}$, $T = +25\text{ }^{\circ}\text{C}$

Applications Information

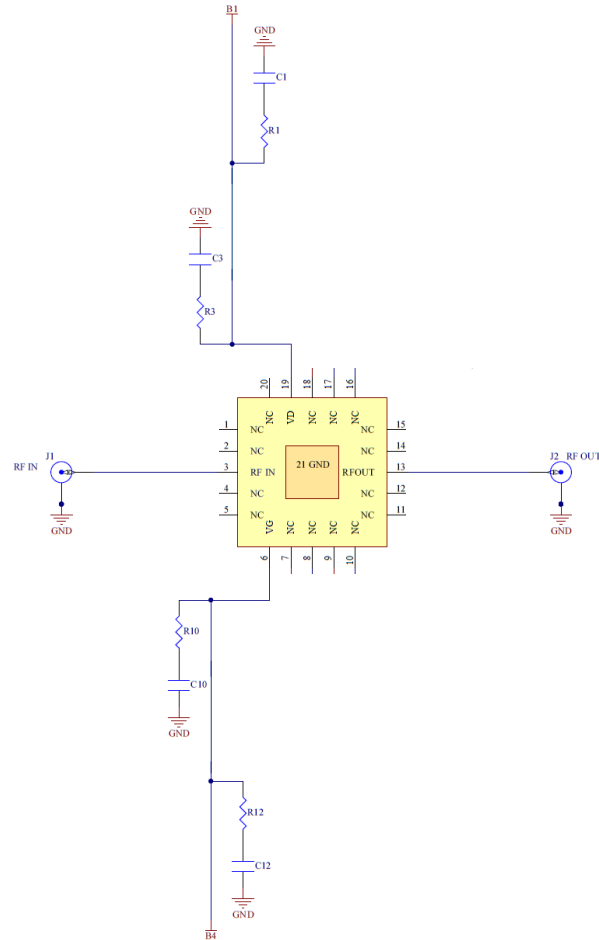

Bias-Up Procedure

- Set V_D supply limit to 300 mA, V_G limit to 30 mA
- Turn on V_G supply and set $V_G = -4$ V
- Turn on V_D supply and set $V_D = 0$ V
- Adjust V_D to 25 V
- Adjust V_G to obtain desired I_{DQ} and apply RF

Bias-Down Procedure

- Turn off RF source
- Set $V_G = -4$ V
- Set $V_D = 0$ V
- Turn off V_D Supply
- Turn off V_G Supply

Evaluation Board (EVB) Layout Assembly

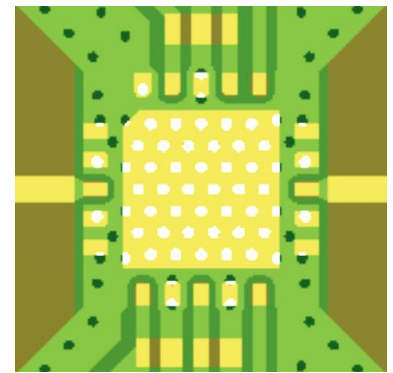
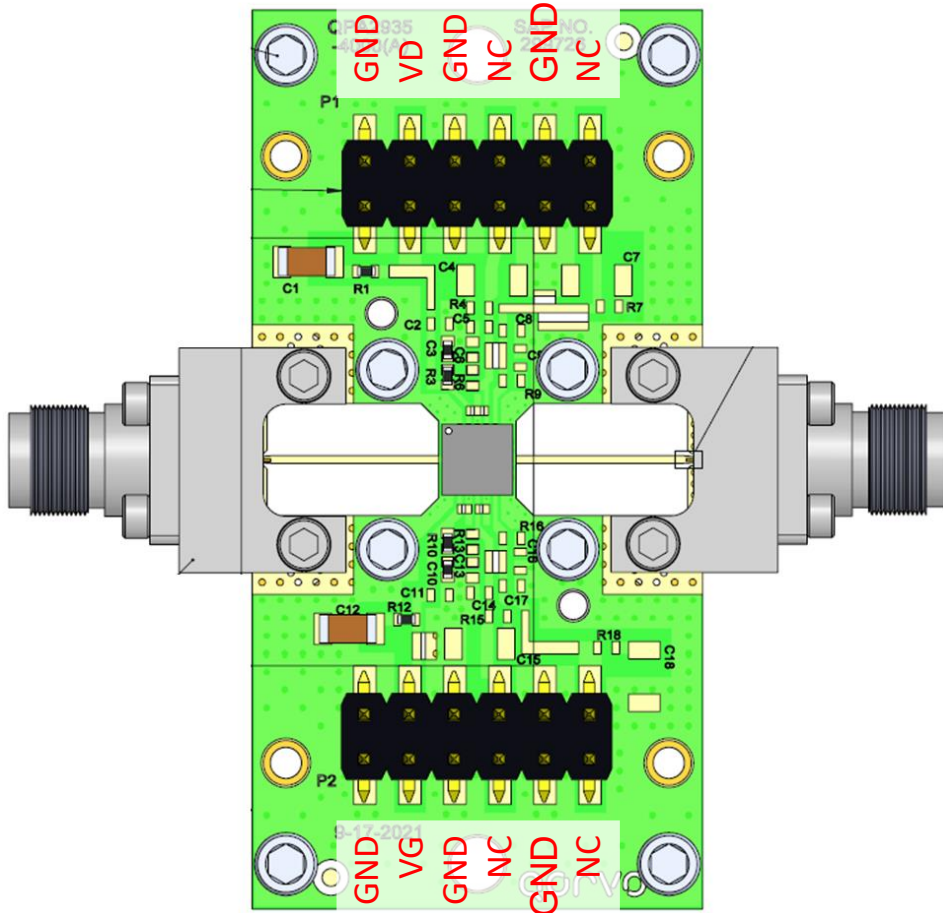

Package Mounting Detail

Thermal vias under the DUT are copper filled and over-plated for improved thermal management. Copper layers are 0.5 oz. both sides. PCB material is Rogers Corp. R4003C, .008 in. thick

Bill of Materials

Reference Des.	Value	Description	Manuf.	Part No.
C1, C12	1.0 uF	CAP, 1uF, 5% 50V, X7R, 1206	Various	
C3, C10	1000 pF	CAP, 1000pF, 10%, 100V, X7R, 0402	Various	
R1, R3, R10, R12	10 Ohm	RES, 10 OHM, 5%, 0.1W, 0402	Various	
J1, J2	2.92 mm	CONN, 2.92, END, F, PIN .005, DIEL .029	Southwest Microwave	1092-01A-5

Mechanical Information

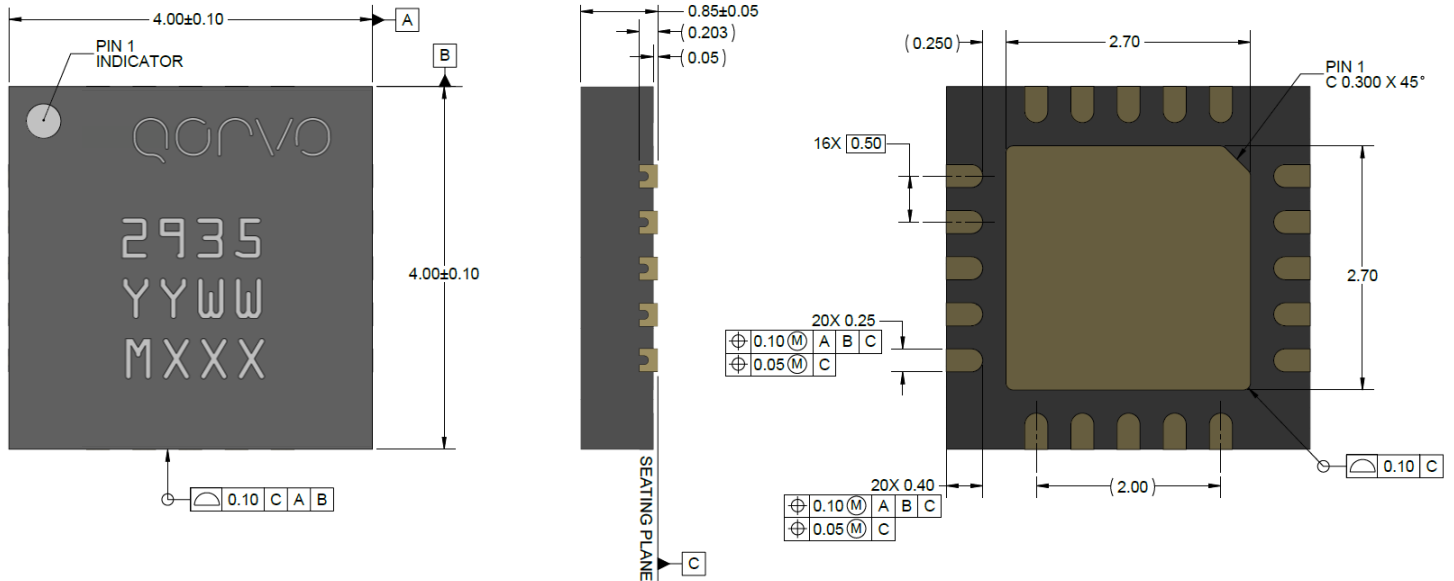

Notes:

Material:

1. Package: plastic overmold compound
2. All package leads are gold plated

Tolerances:

- .XX = $\pm .25$
- .XXX = $\pm .100$
- .XXXX = $\pm .0245$

Unless otherwise specified, dimensions are in mm.

Bond Pad Description

Pad No.	Symbol	Description
1, 2, 4, 5, 7-12, 14-18, 20	NC/GND	No internal connection. May be connected to PCB ground.
3	RF IN	RF input. 50 ohms. DC blocked.
6	VG	Gate voltage. Bypassing required. See Applications Information for details.
13	RF OUT	RF output. 50 Ohms. DC blocked.
19	VD	Drain voltage. Bypassing required. See Applications Information for details.
21	GND	Grounded center pad.

Assembly Notes

Compatible with lead-free soldering processes with 260°C peak reflow temperature.

All package leads are gold plated

Solder rework is not recommended

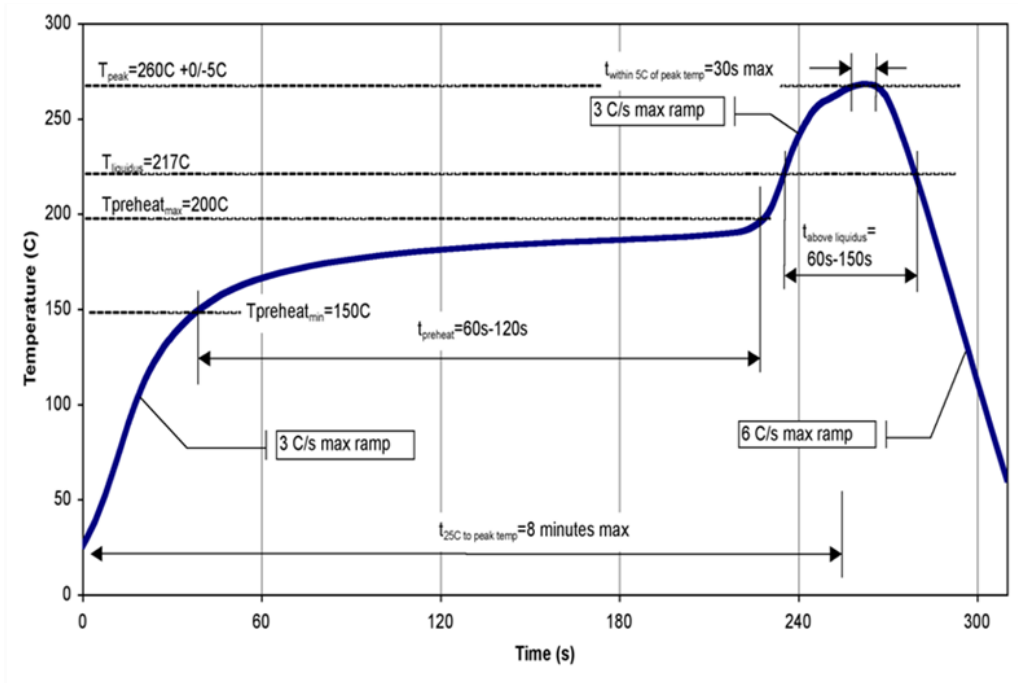

Tape and Reel Information – Carrier and Cover Tape Dimensions

Tape and reel specifications for this part are also available on the Qorvo website.
 Standard T/R size = 250 pieces on a 7" reel.

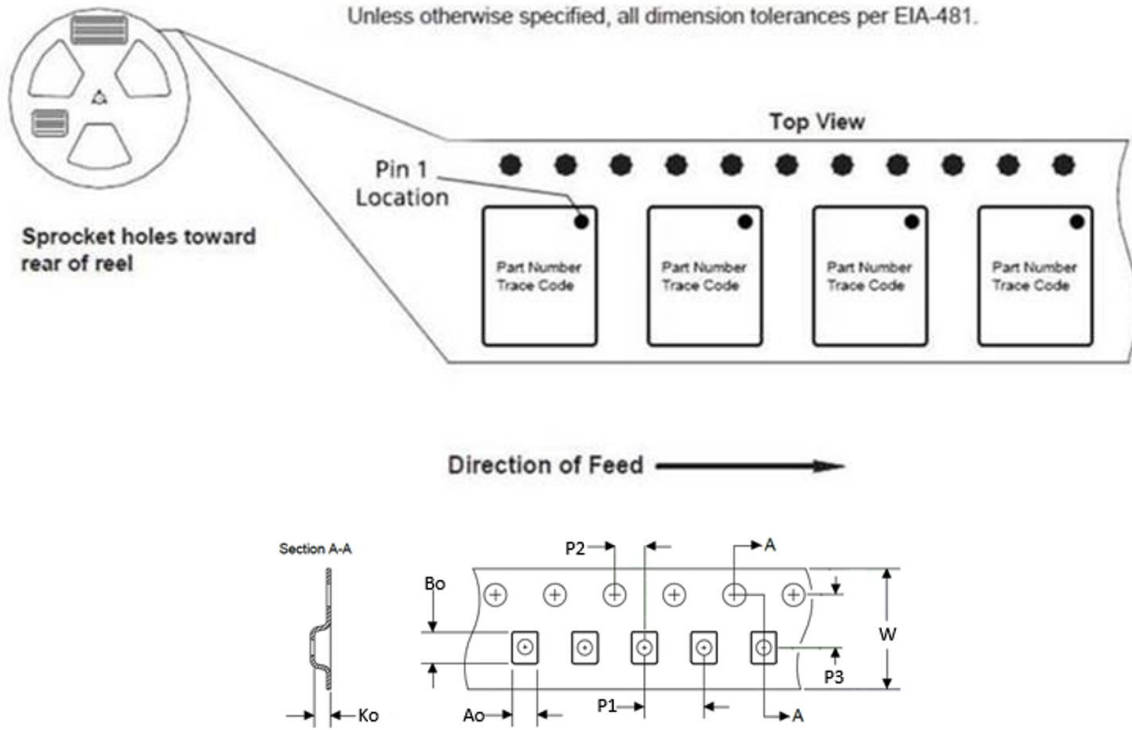

Feature	Measure	Symbol	Size (in)	Size (mm)
Cavity	Length	A0	0.169	4.30
	Width	B0	0.169	4.30
	Depth	K0	0.049	1.25
	Pitch	P1	0.315	8.00
Centerline Distance	Cavity to Perforation - Length Direction	P2	0.079	2.00
	Cavity to Perforation - Width Direction	F	0.217	5.50
Cover Tape	Width	C	0.362	9.20
Carrier Tape	Width	W	0.472	12.00

Tape and Reel Information – Reel Dimensions

Packaging reels are used to prevent damage to devices during shipping and storage, loaded carrier tape is typically wound onto a plastic take-up reel. The reel size is 7" diameter. The reels are made from high-impact injection-molded polystyrene (HIPS), which offers mechanical and ESD protection to packaged devices.

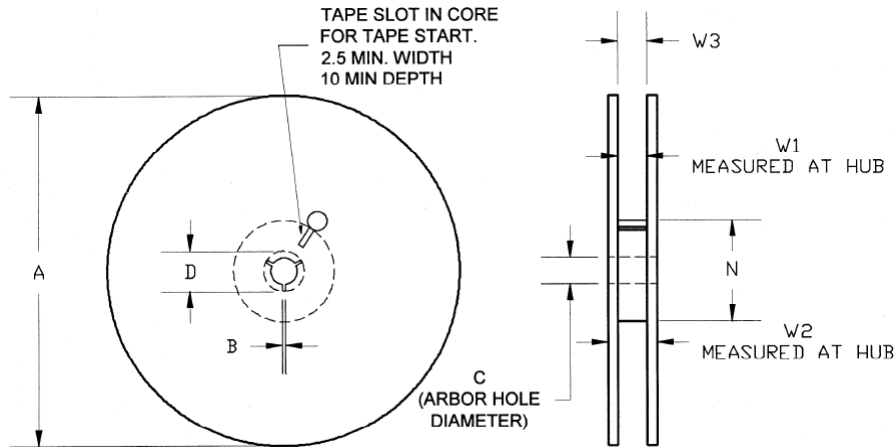

Feature	Measure	Symbol	Size (in)	Size (mm)
Flange	Diameter	A	6.969	177.0
	Thickness	W2	0.724	18.4
	Space Between Flange	W1	0.488	12.4
Hub	Outer Diameter	N	2.283	58.0
	Arbor Hole Diameter	C	0.512	13.0
	Key Slit Width	B	0.079	2.0
	Key Slit Diameter	D	0.795	20.2

Tape and Reel Information – Tape Length and Label Placement

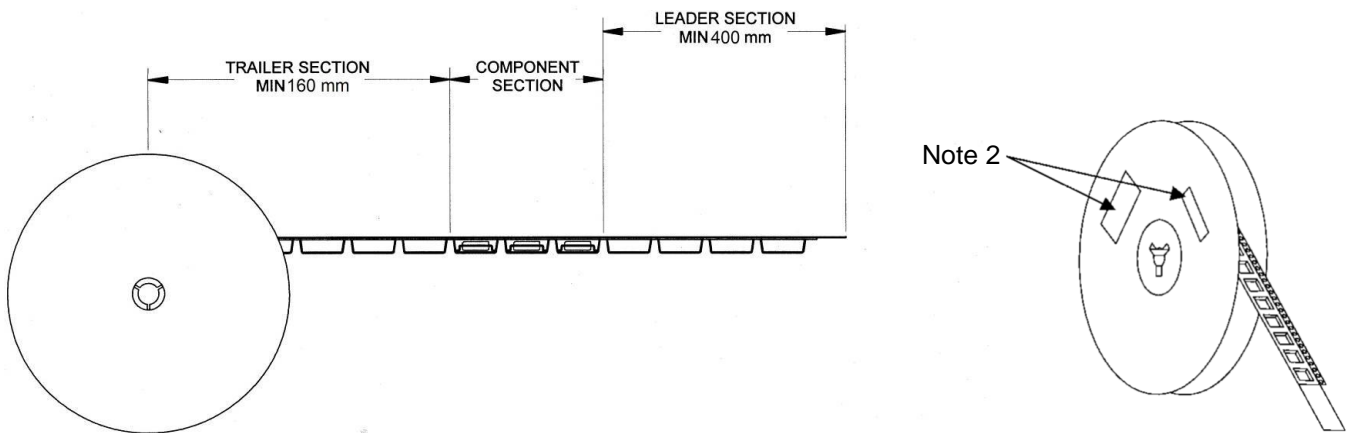

Notes:

1. Empty part cavities at the trailing and leading ends are sealed with cover tape. See EIA 481.
2. Labels are placed on the flange opposite the sprockets in the carrier tape.

Handling Precautions

Parameter	Rating	Standard
ESD – Human Body Model (HBM)	1A	ESDA / JEDEC JS-001-2017
ESD – Charge Device Model (CDM)	C3	ESDA / JEDEC JS-002-2018
MSL – Moisture Sensitivity Level	3	JEDEC standard IPC/JEDEC J-STD-020



Caution!
ESD-Sensitive Device

RoHS Compliance

This product is compliant with the 2011/65/EU RoHS directive (Restrictions on the Use of Certain Hazardous Substances in Electrical and Electronic Equipment), as amended by Directive 2015/863/EU. This product also has the following attributes:

- Lead Free
- Halogen Free (Chlorine, Bromine)
- Antimony Free
- TBBP-A (C15H12Br4O2) Free
- PFOS Free
- SVHC Free

Contact Information

For the latest specifications, additional product information, worldwide sales and distribution locations:

Tel: 1-844-890-8163

Web: www.qorvo.com

Email: customer.support@qorvo.com

Important Notice

The information contained herein is believed to be reliable; however, Qorvo makes no warranties regarding the information contained herein and assumes no responsibility or liability whatsoever for the use of the information contained herein. All information contained herein is subject to change without notice. Customers should obtain and verify the latest relevant information before placing orders for Qorvo products. The information contained herein or any use of such information does not grant, explicitly or implicitly, to any party any patent rights, licenses, or any other intellectual property rights, whether with regard to such information itself or anything described by such information. **THIS INFORMATION DOES NOT CONSTITUTE A WARRANTY WITH RESPECT TO THE PRODUCTS DESCRIBED HEREIN, AND QORVO HEREBY DISCLAIMS ANY AND ALL WARRANTIES WITH RESPECT TO SUCH PRODUCTS WHETHER EXPRESS OR IMPLIED BY LAW, COURSE OF DEALING, COURSE OF PERFORMANCE, USAGE OF TRADE OR OTHERWISE, INCLUDING THE IMPLIED WARRANTIES OF MERCHANTABILITY AND FITNESS FOR A PARTICULAR PURPOSE.**

Without limiting the generality of the foregoing, Qorvo products are not warranted or authorized for use as critical components in medical, life-saving, or life-sustaining applications, or other applications where a failure would reasonably be expected to cause severe personal injury or death.

© 2022 Qorvo US, Inc. All rights reserved. This document is subject to copyright laws in various jurisdictions worldwide and may not be reproduced or distributed, in whole or in part, without the express written consent of Qorvo US, Inc.

Looking for pricing, stock, or lifecycle information?

Click below to explore more details on WIN SOURCE:

 [View QPA2935 on WIN SOURCE](#)

 [Qorvo US Inc. Information](#)

Optimize Your Supply Chain with WIN SOURCE Solutions

-  Global Sourcing Solution
-  Obsolete Management
-  Cost Control Management
-  Shortage Management
-  Alternative Solution
-  Excess Inventory Management