



**THE DATASHEET OF
PMA3-24323LN+**





MMIC SURFACE MOUNT

Low Noise Amplifier PMA3-24323LN+

50Ω 24 to 32 GHz High Dynamic Range

THE BIG DEAL

- Wideband, 24 to 32 GHz
- Low Noise Figure, Typ. 3.1 dB
- High OIP3, Typ. +25 dBm
- High P1dB, Typ. +17 dBm
- Single +5 V positive supply voltage
- 3x3mm, 12-Lead QFN Style Package

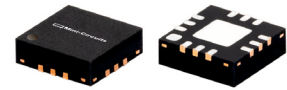

Generic photo used for illustration purposes only

APPLICATIONS

- Satellite Communications
- Test & Measurement Equipment
- 5G mmWave and Back Haul Radio Systems
- Radar, EW, and ECM Defense Systems

FUNCTIONAL DIAGRAM

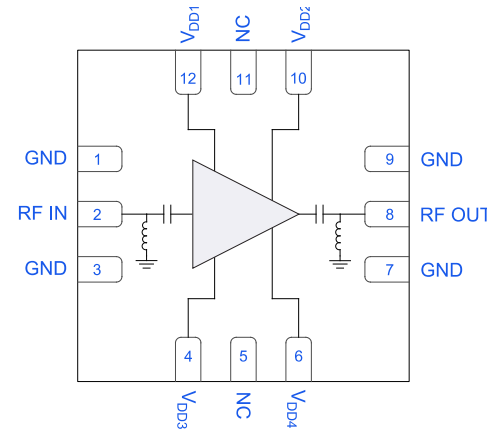

PRODUCT OVERVIEW

The PMA3-24323LN+ is a pHEMT based wideband, low noise MMIC amplifier with a unique combination of high dynamic range and low noise figure over a very broad bandwidth making it ideal for use in a wide variety of transmitter and receiver applications. This amplifier offers market competitive performance focused on Ka-band satellite communications applications as a 50Ω matched amplifier requiring no external matching. The PMA3-24323LN+ is ideal as a 2nd stage amplifier without degrading overall system noise floor on the receive side, or as a low noise pre-driver or driver on the transmit side. This design operates on a single 5V positive supply and comes in a small plastic package (3 x 3 x 0.89mm), accommodating dense circuit board layouts.

KEY FEATURES

Feature	Advantages
Low Noise Figure, Typ. 3.1 dB	Enables lower system noise figure performance.
High Dynamic Range. <ul style="list-style-type: none"> • OIP3, Typ. +25 dBm • P1dB, Typ. +17 dBm 	Offers low noise figure with correspondingly high P1dB and OIP3 enables flexibility to achieve high Dynamic range system performance
3x3mm 12-lead QFN Style Package	Tiny footprint saves space in dense layouts while providing low inductance, repeatable transitions, and excellent thermal contact to the PCB.





MMIC SURFACE MOUNT

Low Noise Amplifier PMA3-24323LN+

50Ω 24 to 32 GHz High Dynamic Range

ELECTRICAL SPECIFICATIONS¹ AT 25°C, AND V_S= +5V, UNLESS NOTED OTHERWISE

Parameter	Condition (GHz)	Min.	Typ.	Max.	Units
Frequency Range		24		32	GHz
Gain	24	14.7	16.1		dB
	28	15.1	16.6		
	32	14.5	16.4		
Output Power at 1 dB Compression (P1dB)	24		+15.2		dBm
	28		+16.8		
	32		+16.8		
Output Third-Order Intercept (P _{OUT} = -5 dBm/Tone)	24		+25		dBm
	28		+24		
	32		+25		
Input Return Loss	24		9		dB
	28		14		
	32		9		
Output Return Loss	24		9		dB
	28		11		
	32		13		
Isolation	24-32		40		dB
Noise Figure	24		2.6		dB
	28		2.8		
	32		3.8		
Device Operating Voltage (V _S)		+4.75	+5	+5.25	V
Device Operating Current (I _S) ²			128		mA
DC Current Variation vs. Temperature ³			-19.23		μA/°C
DC Current Variation vs. Voltage ⁴			0.03		mA/mV

1. Tested in Mini-Circuits Characterization Test/Evaluation Board TBPMA324323LNC+. See Figure 2. Board loss de-embedded to the device.

2. Current at P_{IN} = -25 dBm. Increases to 139 mA at P1dB.

3. ((Current at +85°C - Current at -45°C) / (+130°C))

4. (Current at +5.25V in mA) - (Current at +4.75V mA) / ((+5.25V - +4.75V)*1000mA/mV)



TYPICAL PERFORMANCE GRAPHS

GAIN vs. TEMPERATURE,
 $P_{IN} = -25 \text{ dBm}, V_S = +5 \text{ V}$

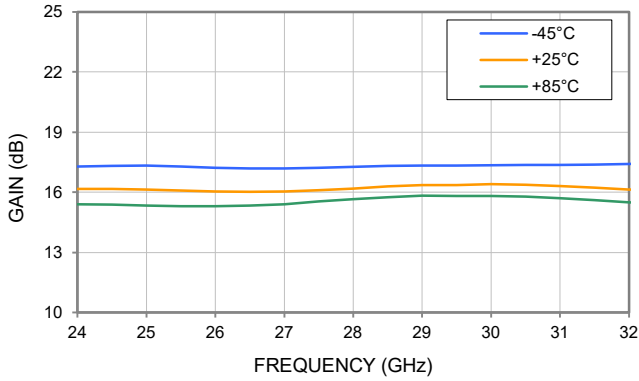

GAIN vs. DEVICE VOLTAGE,
 $P_{IN} = -25 \text{ dBm}, \text{TEMPERATURE} = +25^\circ\text{C}$

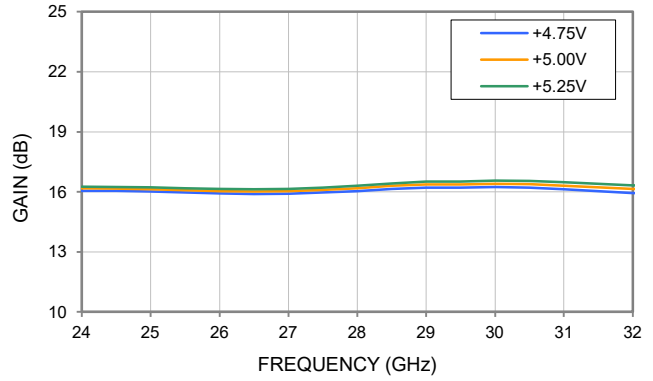

INPUT RETURN LOSS vs. TEMPERATURE,
 $P_{IN} = -25 \text{ dBm}, V_S = +5 \text{ V}$

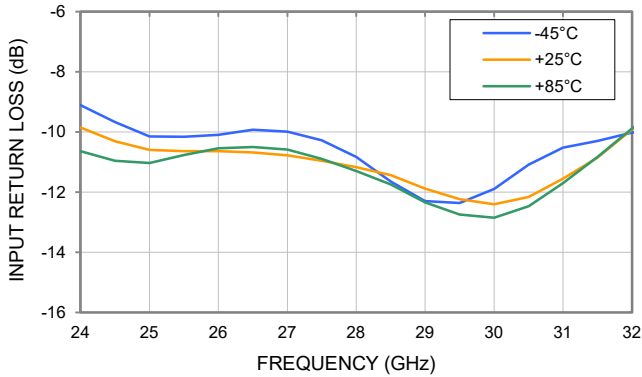

INPUT RETURN LOSS vs. DEVICE VOLTAGE,
 $P_{IN} = -25 \text{ dBm}, \text{TEMPERATURE} = +25^\circ\text{C}$

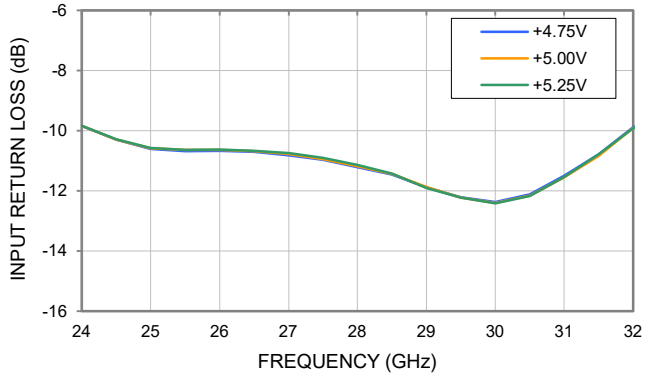

OUTPUT RETURN LOSS vs. TEMPERATURE,
 $P_{IN} = -25 \text{ dBm}, V_S = +5 \text{ V}$

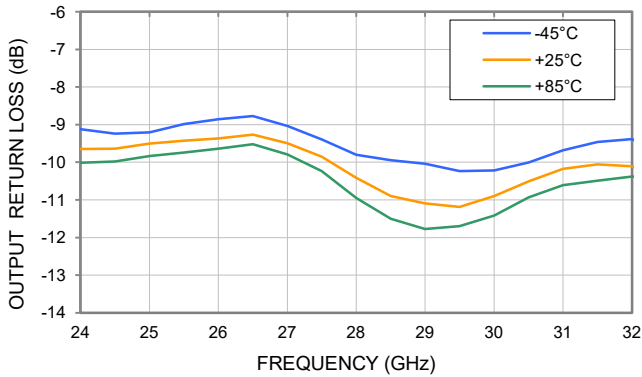

OUTPUT RETURN LOSS vs. DEVICE VOLTAGE,
 $P_{IN} = -25 \text{ dBm}, \text{TEMPERATURE} = +25^\circ\text{C}$

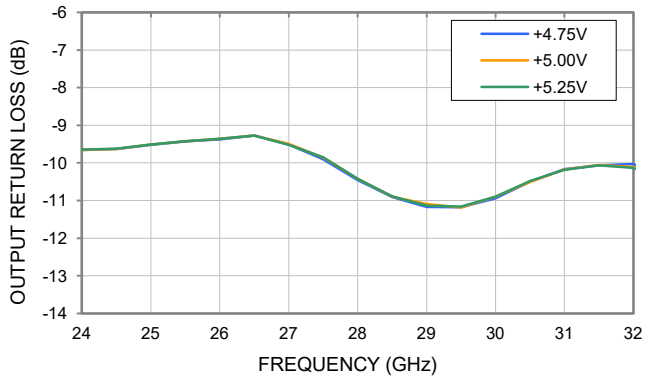



TYPICAL PERFORMANCE GRAPHS

ISOLATION vs. TEMPERATURE,
 $P_{IN} = -25 \text{ dBm}$, $V_S = +5 \text{ V}$

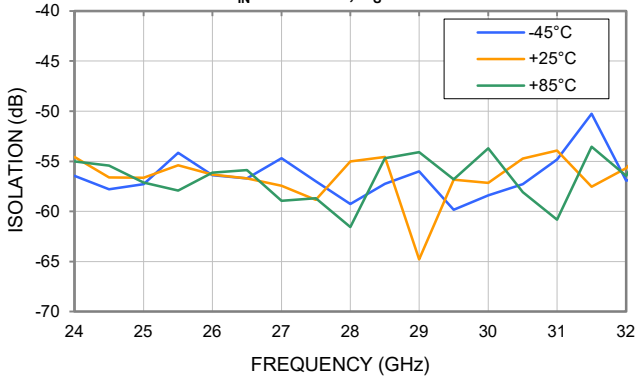

ISOLATION vs. DEVICE VOLTAGE,
 $P_{IN} = -25 \text{ dBm}$, TEMPERATURE = +25°C

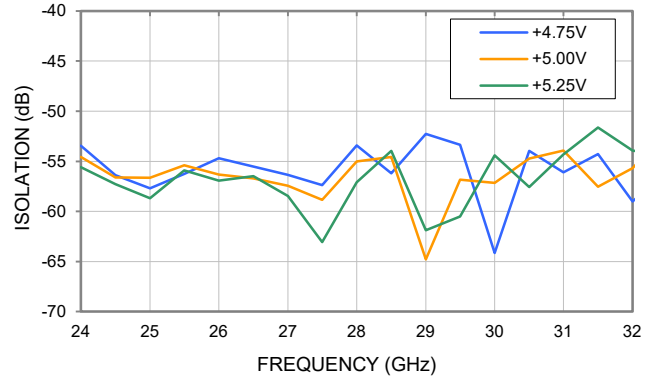

P1dB vs. TEMPERATURE,
 $V_S = +5 \text{ V}$

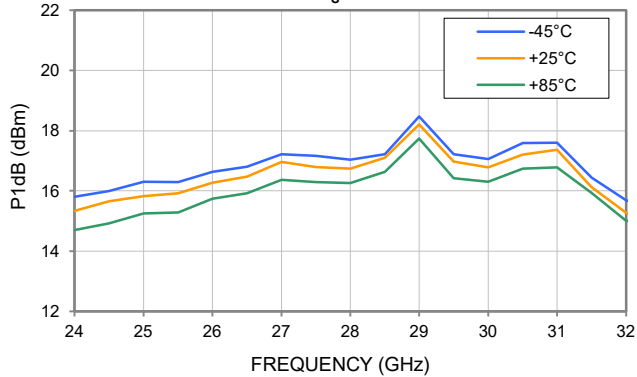

P1dB vs. DEVICE VOLTAGE,
TEMPERATURE = +25°C

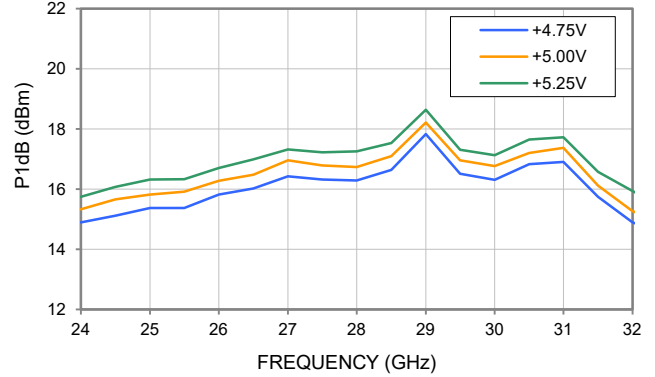

OUTPUT IP3 vs. TEMPERATURE,
 $P_{OUT} = -5 \text{ dBm/TONE}$, $V_S = +5 \text{ V}$

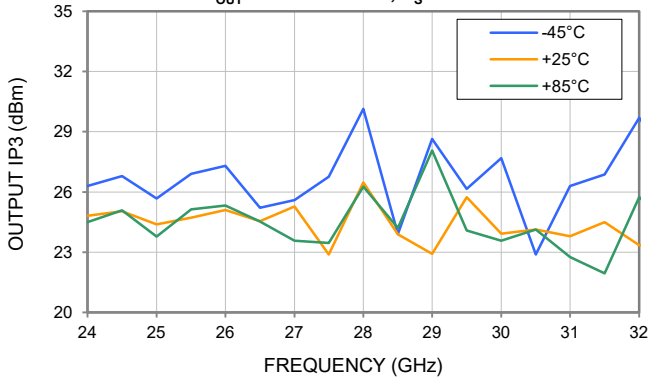

OUTPUT IP3 vs. DEVICE VOLTAGE,
 $P_{OUT} = -5 \text{ dBm/TONE}$, TEMPERATURE = +25°C

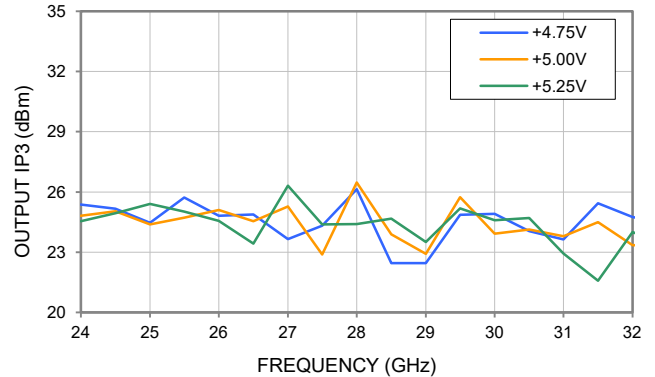



MMIC SURFACE MOUNT

Low Noise Amplifier PMA3-24323LN+

50Ω 24 to 32 GHz High Dynamic Range

TYPICAL PERFORMANCE GRAPHS

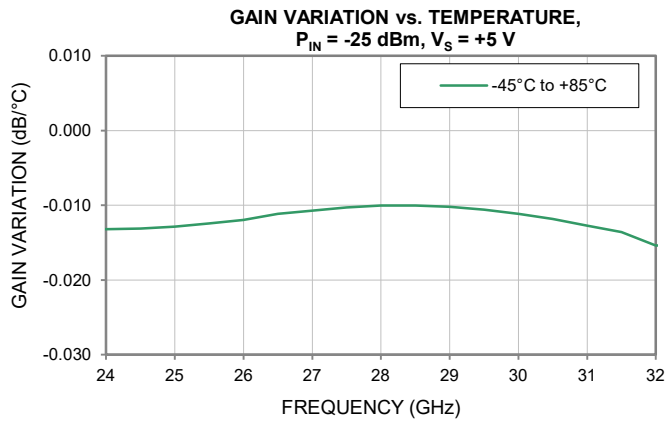
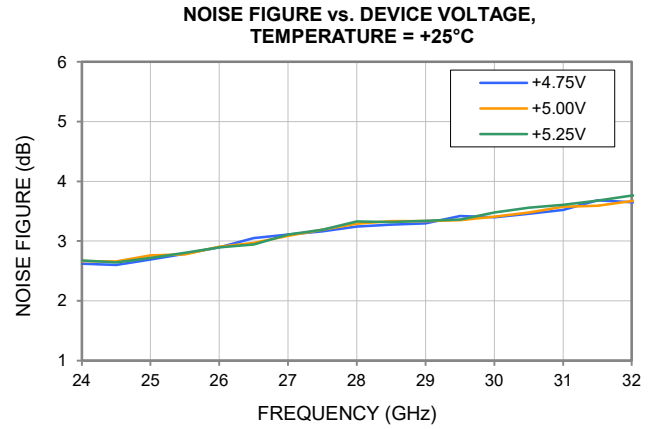
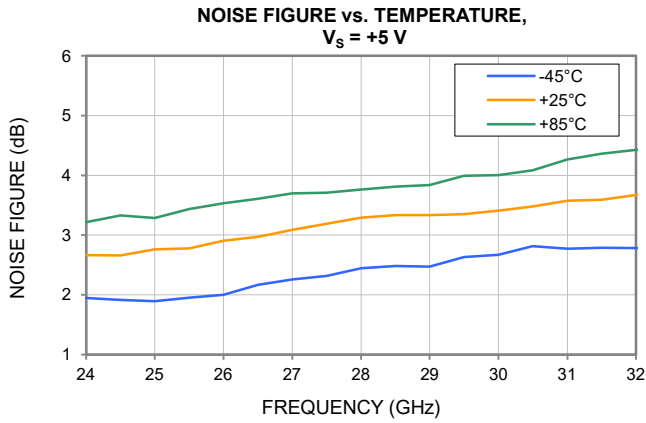



MMIC SURFACE MOUNT

Low Noise Amplifier **PMA3-24323LN+**

50Ω 24 to 32 GHz High Dynamic Range

ABSOLUTE MAXIMUM RATINGS⁵

Parameter	Ratings
Operating Temperature	-45 °C to +85 °C
Storage Temperature	-65 °C to +150 °C
Junction Temperature ⁶	+150 °C
Total Power Dissipation	1.62 W
Input Power (CW), $V_S = +5$ V	+23 dBm
DC Voltage at V_{DD1} , V_{DD2} , V_{DD3} , V_{DD4}	+10 V

5. Permanent damage may occur if any of these limits are exceeded. Maximum ratings are not intended for continuous normal operation.

6. Peak temperature on top of Die.

THERMAL RESISTANCE

Parameter	Ratings
Thermal Resistance (Θ_{JC}) ⁷	32.2°C/W

7. Θ_{JC} = (Hot Spot Temperature on Die - Temperature at Ground Lead)/Dissipated Power

ESD RATING

	Class	Voltage Range	Reference Standard
Human Body Model (HBM)	1A	250V to <500V	ANSI/ESDA/JEDEC JS-001-2017



ESD HANDLING PRECAUTION: This device is designed to be Class 1A for HBM. Static charges may easily produce potentials higher than this with improper handling and can discharge into DUT and damage it. As a preventive measure Industry standard ESD handling precautions should be used at all times to protect the device from ESD damage.

MSL RATING

Moisture Sensitivity: MSL1 in accordance with IPC/JEDEC J-STD-020E/JEDEC J-STD-033C



MMIC SURFACE MOUNT

Low Noise Amplifier **PMA3-24323LN+**

50Ω 24 to 32 GHz High Dynamic Range

FUNCTIONAL DIAGRAM

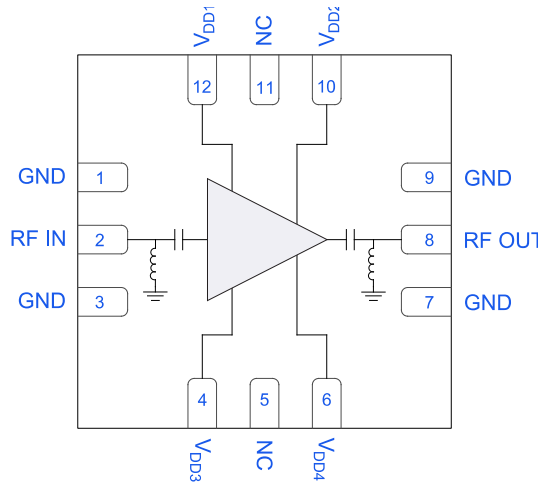

PAD DESCRIPTION

Function	Pad Number	Description (Refer to Figure 2)
RF-IN	2	RF-IN Pad connects to RF Input port.
RF-OUT	8	RF-OUT Pad connects to RF Output port.
V _{DD1}	12	DC Input Pad connects to voltage input port V _{DD1}
V _{DD2}	10	DC Input Pad connects to voltage input port V _{DD2}
V _{DD3}	4	DC Input Pad connects to voltage input port V _{DD3}
V _{DD4}	6	DC Input Pad connects to voltage input port V _{DD4}
GND	1, 3, 7, 9	GND Pads connect to Ground
NC	5, 11	Not used internally. Connected to ground on test board.

Figure 1. PMA3-24323LN+ Functional Diagram

CHARACTERIZATION TEST BOARD

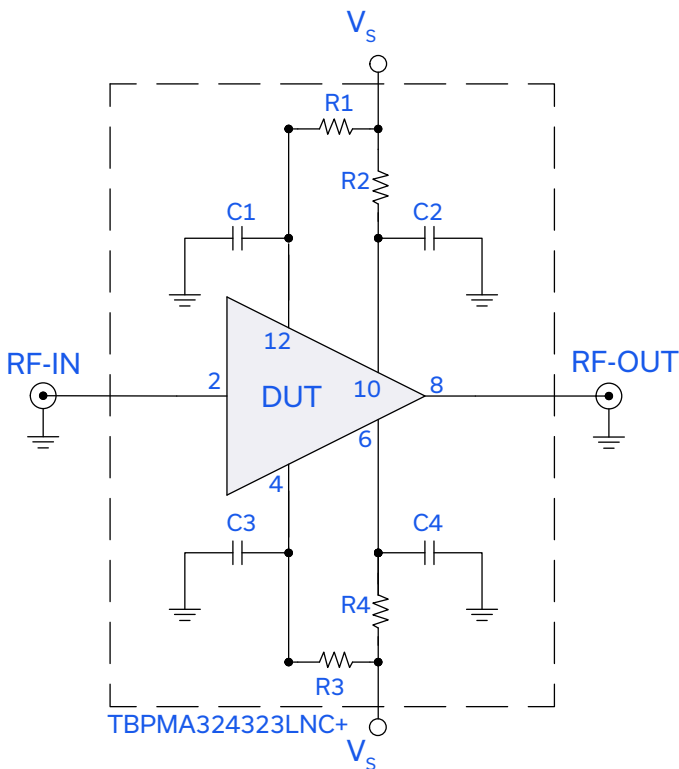

Gain, Return Loss, Output Power at 1dB Compression (P_{1dB}), Output IP₃ (OIP₃) and Noise Figure measured using N5242A PNA-X microwave network analyzer.

Conditions:

- Gain and Return Loss: P_{IN} = -25 dBm
- Output IP₃ (OIP₃): Two tones, spaced 1 MHz apart, -5 dBm/tone at output
- V_s = +5 V

Component	Vendor	Vendor P/N	Value	Size
C1, C2, C3, C4	Murata	GRM1555C1H101JA01D	100 pF	0402
R1, R3	KOA	SG73P1JTTD39R0F	39 Ω	0603
R2, R4	KOA	SG73S1JTTD24R0F	24 Ω	0603

Figure 2. DUT soldered on Mini-Circuits Characterization Test Board TBPMA324323LNC+



CASE STYLE DRAWING

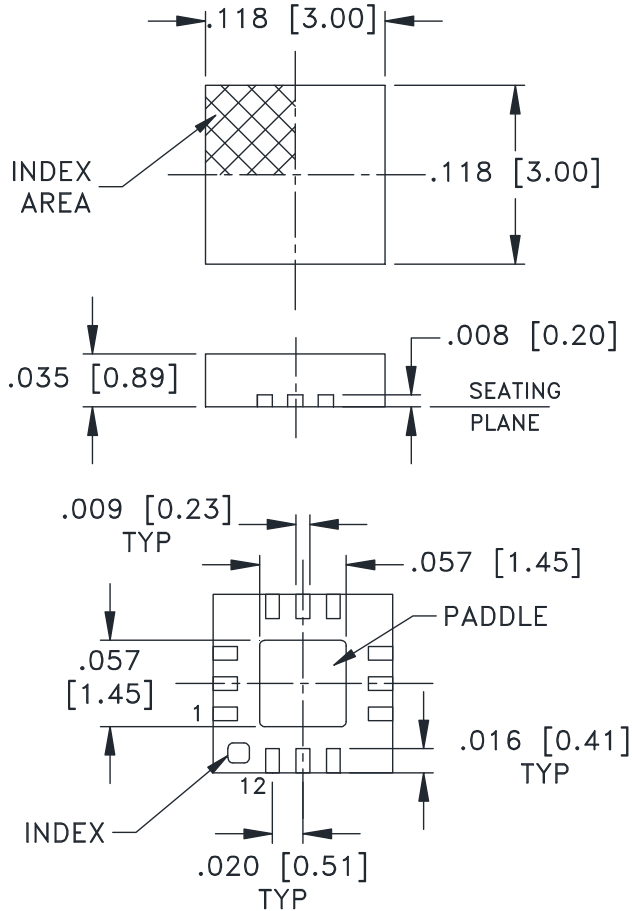

PCB Land Pattern

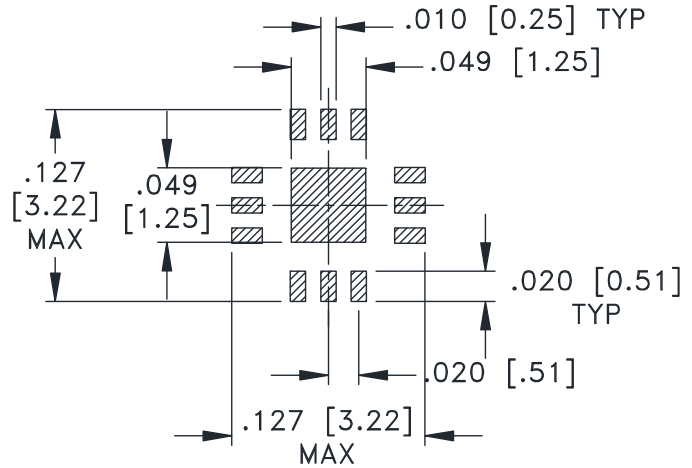

SUGGESTED LAYOUT,
TOLERANCE TO BE WITHIN ±.002

Weight: .02 Grams

Dimensions are in inches [mm].

Figure 3. DQ1225 Case Style Drawing

PRODUCT MARKING



Marking may contain other features or characters for internal lot control

Figure 4. PMA3-24323LN+ Product Marking



MMIC SURFACE MOUNT

Low Noise Amplifier **PMA3-24323LN+**

50Ω 24 to 32 GHz High Dynamic Range

ADDITIONAL DETAILED INFORMATION IS AVAILABLE ON OUR DASHBOARD [CLICK HERE](#)

Performance Data	Data
	Graphs
	S-Parameter (S2P Files) Data Set (.zip file)
Case Style	DQ1225 Plastic package, exposed paddle, lead finish: Matte-Tin
RoHs Status	Compliant
Tape & Reel	F66
Standard quantities available on reel	7" reels with 20, 50, 100, 200, 500,1K or 2K devices
Suggested Layout for PCB Design	PL-731
Evaluation Board	TBPMA324323LNC+ Gerber File
Environmental Ratings	ENV08T1

NOTES

- A. Performance and quality attributes and conditions not expressly stated in this specification document are intended to be excluded and do not form a part of this specification document.
- B. Electrical specifications and performance data contained in this specification document are based on Mini-Circuit's applicable established test performance criteria and measurement instructions.
- C. The parts covered by this specification document are subject to Mini-Circuits standard limited warranty and terms and conditions (collectively, "Standard Terms"); Purchasers of this part are entitled to the rights and benefits contained therein. For a full statement of the standard terms and the exclusive rights and remedies thereunder, please visit Mini-Circuits' website at www.minicircuits.com/terms/viewterm.html



Looking for pricing, stock, or lifecycle information?

Click below to explore more details on WIN SOURCE:

 [View PMA3-24323LN+ on WIN SOURCE](#)

 [Mini-Circuits Information](#)

Optimize Your Supply Chain with WIN SOURCE Solutions

-  Global Sourcing Solution
-  Obsolete Management
-  Cost Control Management
-  Shortage Management
-  Alternative Solution
-  Excess Inventory Management