



**THE DATASHEET OF  
AVA-2183+**





MMIC SURFACE MOUNT

# Wideband Amplifier

## AVA-2183+

Mini-Circuits

50Ω 2 to 20 GHz Excellent Gain Flatness

### THE BIG DEAL

- Wideband 2 to 20 GHz
- Flat Gain, Typ. 16 ± 1 dB
- P1dB, Typ. +19 dBm
- OIP3, Typ. +25 dBm
- 4x4 mm 20-Lead QFN-Style Package

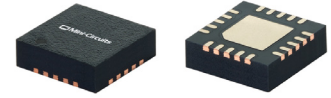

Generic photo used for illustration purposes only

### APPLICATIONS

- 5G MIMO and Back Haul Radio Systems
- Satellite Communications
- Test and Measurement Equipment
- Radar, EW, and ECM Defense Systems

### FUNCTIONAL DIAGRAM

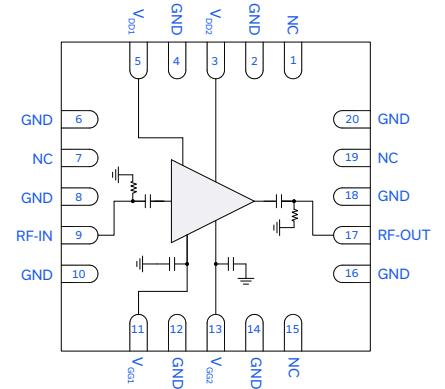

### PRODUCT OVERVIEW

The AVA-2183+ is a GaAs pHEMT MMIC Amplifier that operates from 2 to 20 GHz. At 10 GHz the amplifier provides typical performance of 16.4 dB Gain, 5.2 dB Noise Figure, +19.3 dBm P1dB, and +24.7 dBm OIP3 from a +4 V supply drawing 210 mA. The AVA-2183+ MMIC amplifier is housed in an industry standard 4x4 mm 20-lead QFN-style package. With the RF ports internally matched to 50Ω, this amplifier enables easy integration into microwave systems.

### KEY FEATURES

| Features   | Advantages  |
|--|---|
| Wideband: 2 to 20 GHz<br>• Gain, Typ. 16 dB                      | Suitable for a variety of applications from wideband test and measurement equipment, and defense systems as well as narrowband telecommunications and satellite communications. |
| Good P1dB & OIP3<br>• P1dB, Typ. +19 dBm<br>• OIP3, Typ. +25 dBm | Suitable as a linear gain block or as an LO driver for mixers in transmitter or receiver lineups.   |
| Good Input and Output Return Loss                                | Internally matched to 50Ω, this eliminates the need for external matching components making the device easy to integrate.   |
| 4x4 mm 20-Lead QFN-Style Package                                 | Small footprint saves space in dense layouts while providing low inductance, repeatable transitions, and excellent thermal contact to the PCB.                                  |

REV. OR  
ECO-017253  
AVA-2183+  
MCL NY  
250904





MMIC SURFACE MOUNT

## Wideband Amplifier

AVA-2183+

Mini-Circuits

50Ω 2 to 20 GHz Excellent Gain Flatness

ELECTRICAL SPECIFICATIONS<sup>1</sup> AT +25°C, Z<sub>0</sub> = 50Ω, V<sub>DD</sub> = +4 V, I<sub>DD</sub> = 210 mA, UNLESS NOTED OTHERWISE

| Parameter  | Condition (GHz) | Min.  | Typ.  | Max.  | Units |
|--|-----------------|-------|-------|-------|-------|
| Frequency Range  |                 | 2     |       | 20    | GHz   |
| Gain   | 2               | 12.9  | 15.0  |       | dB    |
|  | 5               | 14.2  | 15.6  |       |       |
|  | 10              | 15.7  | 16.4  |       |       |
|  | 15              | 15.1  | 16.2  |       |       |
|  | 20              | 13.7  | 15.9  |       |       |
| Input Return Loss  | 2               |       | 11.4  |       | dB    |
|  | 5               |       | 15.6  |       |       |
|  | 10              |       | 14.8  |       |       |
|  | 15              |       | 14.6  |       |       |
|  | 20              |       | 16.4  |       |       |
| Output Return Loss   | 2               |       | 18.9  |       | dB    |
|  | 5               |       | 20    |       |       |
|  | 10              |       | 20    |       |       |
|  | 15              |       | 19.8  |       |       |
|  | 20              |       | 16.3  |       |       |
| Isolation  | 2-20            |       | 60.8  |       | dB    |
| Output Power at 1 dB Compression (P <sub>1dB</sub> )               | 2               |       | +18.4 |       | dBm   |
|  | 5               |       | +18.9 |       |       |
|  | 10              |       | +19.3 |       |       |
|  | 15              |       | +18.4 |       |       |
|  | 20              |       | +16.9 |       |       |
| Output Third-Order Intercept Point (P <sub>OUT</sub> = 0 dBm/Tone) | 2               |       | +27.9 |       | dBm   |
|  | 5               |       | +26.3 |       |       |
|  | 10              |       | +24.7 |       |       |
|  | 15              |       | +22.9 |       |       |
|  | 20              |       | +20.0 |       |       |
| Noise Figure   | 2               |       | 6.7   |       | dB    |
|  | 5               |       | 6.3   |       |       |
|  | 10              |       | 5.2   |       |       |
|  | 15              |       | 4.5   |       |       |
|  | 20              |       | 5.1   |       |       |
| Device Operating Voltage (V <sub>DD</sub> )                        |                 | +3.75 | +4    | +4.25 | V     |
| Device Operating Current (I <sub>DD</sub> ) <sup>2</sup>           |                 |       | 210   |       | mA    |
| Gate Voltage (V <sub>GG</sub> ) <sup>3</sup>                       |                 |       | -0.52 |       | V     |
| Gate Current (I <sub>GG</sub> )                                    |                 |       | -0.2  |       | μA    |
| Device Current Variation vs. Temperature <sup>4</sup>              |                 |       | 0.48  |       | μA/°C |
| Device Current Variation vs. Voltage <sup>5</sup>                  |                 |       | 0.005 |       | mA/mV |

1. Tested on Mini-Circuits Characterization Test/Evaluation Board TB-AVA-2183C+. See Figure 2. De-embedded to the device reference plane.

2. Current at P<sub>IN</sub> = -25 dBm. Increases to 230 mA at P<sub>1dB</sub>.

3. Typical Gate Voltage for when I<sub>DD</sub> = 210 mA. V<sub>GG</sub> must be adjusted so that I<sub>DD</sub> = 210 mA.

4. (Current at T<sub>max</sub>°C - Current at T<sub>min</sub>°C) / (T<sub>max</sub>°C - T<sub>min</sub>°C)

5. (Current at Nominal V +ΔV in mA) - (Current at Nominal V -ΔV mA)/(2ΔV mV)





### TYPICAL PERFORMANCE GRAPHS

All data taken was at nominal conditions  $V_{DD} = +4\text{ V}$  and  $I_{DD} = 210\text{ mA}$  unless noted otherwise. For over temperature data,  $V_{GG}$  is adjusted to achieve  $I_{DD} = 210\text{ mA}$  at each temperature specified. For over voltage data,  $V_{GG}$  is adjusted to achieve  $I_{DD} = 210\text{ mA}$  at each voltage specified.

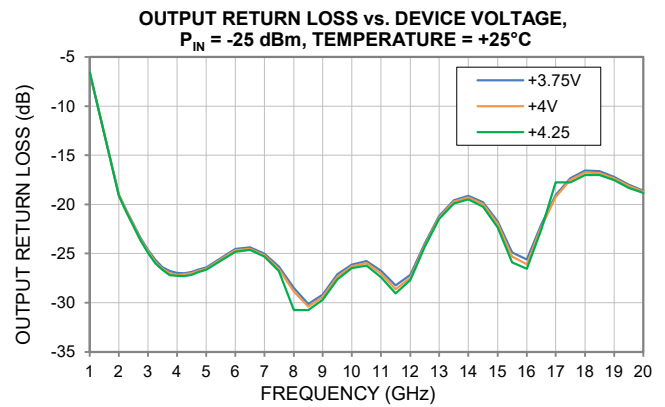
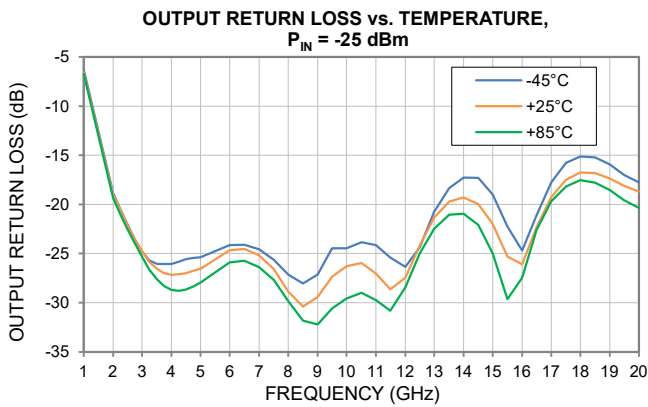
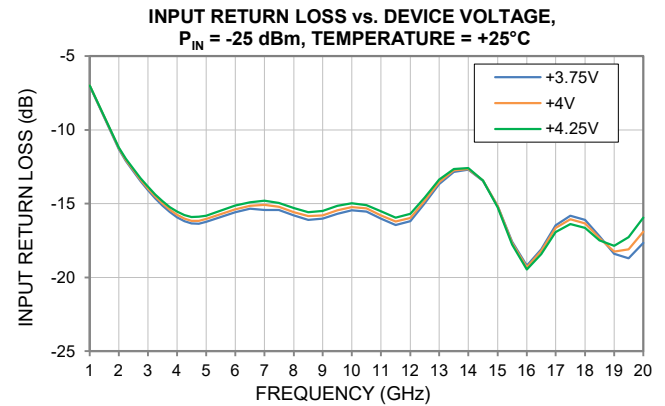
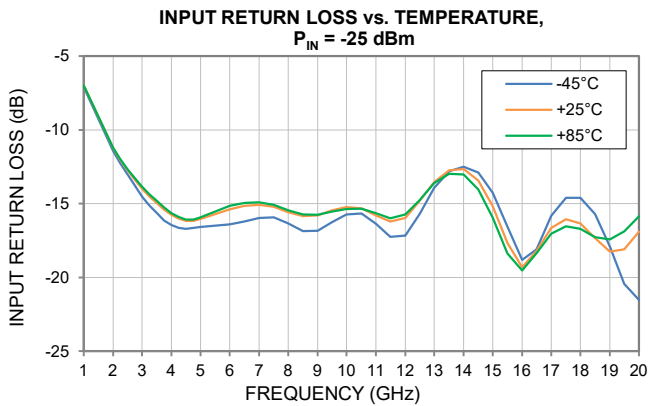
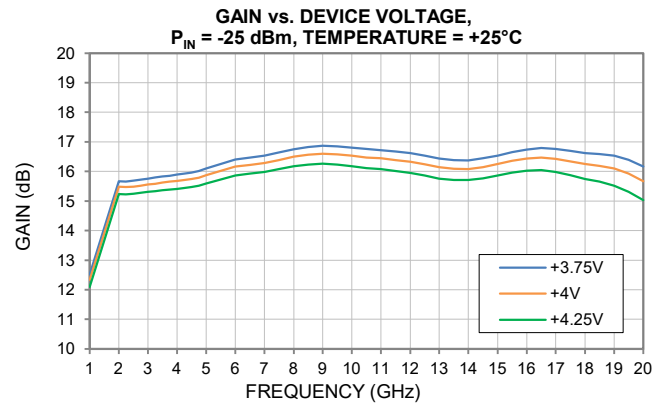
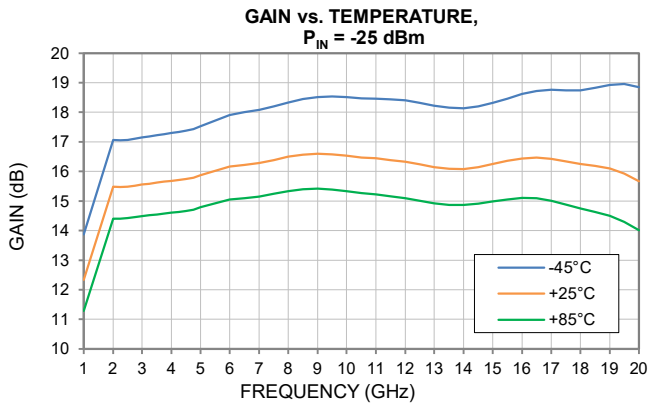



### TYPICAL PERFORMANCE GRAPHS

All data taken was at nominal conditions  $V_{DD} = +4\text{ V}$  and  $I_{DD} = 210\text{ mA}$  unless noted otherwise. For over temperature data,  $V_{GG}$  is adjusted to achieve  $I_{DD} = 210\text{ mA}$  at each temperature specified. For over voltage data,  $V_{GG}$  is adjusted to achieve  $I_{DD} = 210\text{ mA}$  at each voltage specified.

ISOLATION vs. TEMPERATURE,  
 $P_{IN} = -25\text{ dBm}$

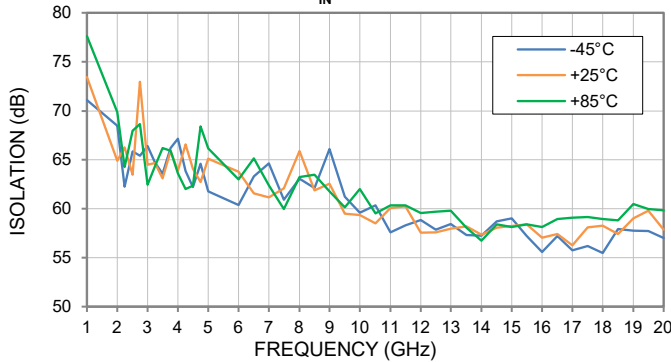

ISOLATION vs. DEVICE VOLTAGE,  
 $P_{IN} = -25\text{ dBm}$ , TEMPERATURE = +25°C

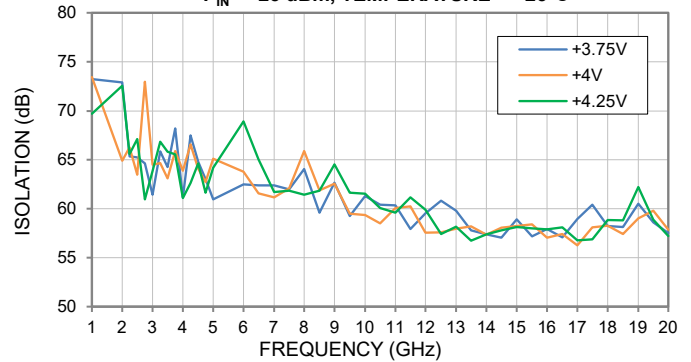

OUTPUT IP3 vs. TEMPERATURE,  
 $P_{OUT} = 0\text{ dBm/TONE}$

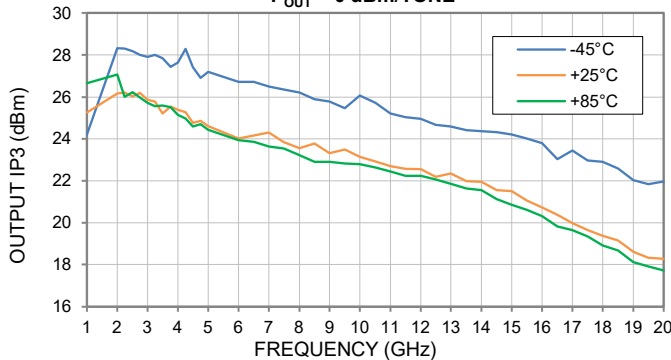

OUTPUT IP3 vs. DEVICE VOLTAGE,  
 $P_{OUT} = 0\text{ dBm/TONE}$ , TEMPERATURE = +25°C

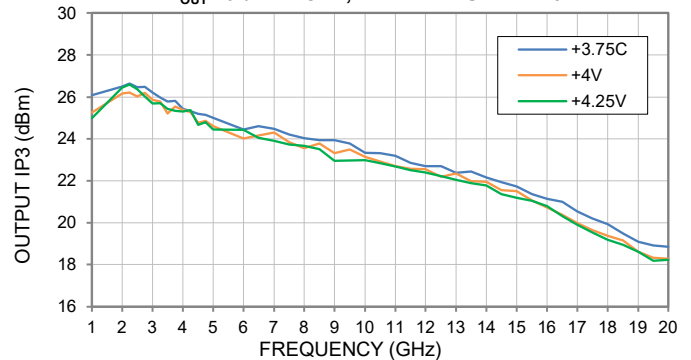

P1dB vs. TEMPERATURE

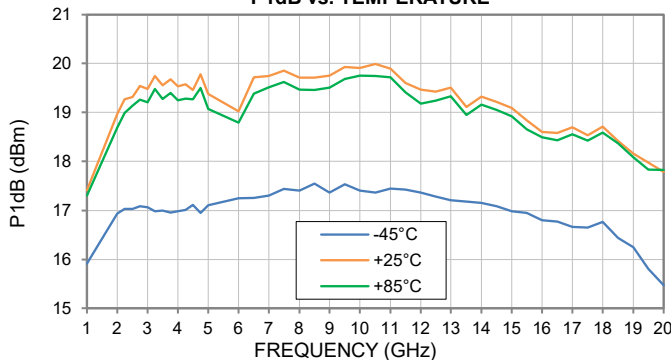

P1dB vs. DEVICE VOLTAGE,  
TEMPERATURE = +25°C

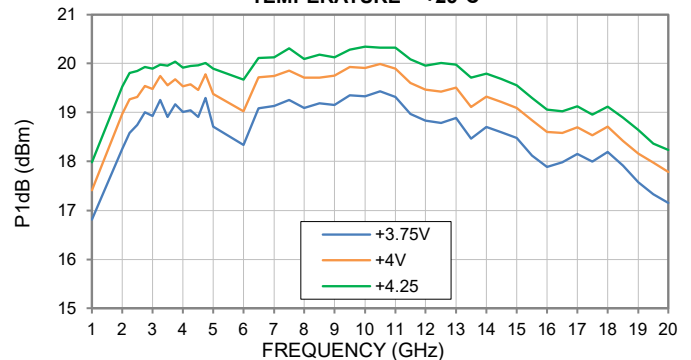



### TYPICAL PERFORMANCE GRAPHS

All data taken was at nominal conditions  $V_{DD} = +4\text{ V}$  and  $I_{DD} = 210\text{ mA}$  unless noted otherwise. For over temperature data,  $V_{GG}$  is adjusted to achieve  $I_{DD} = 210\text{ mA}$  at each temperature specified. For over voltage data,  $V_{GG}$  is adjusted to achieve  $I_{DD} = 210\text{ mA}$  at each voltage specified.

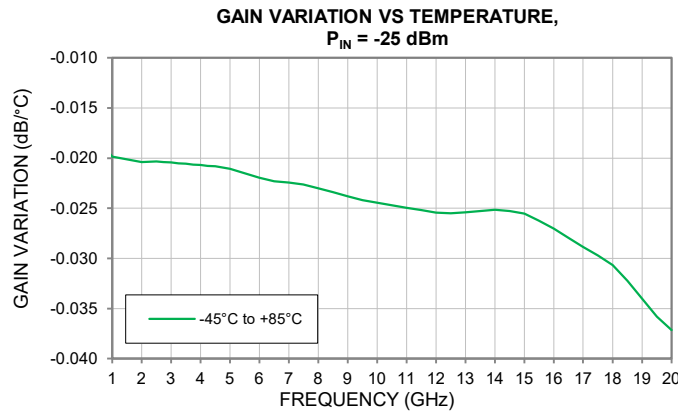
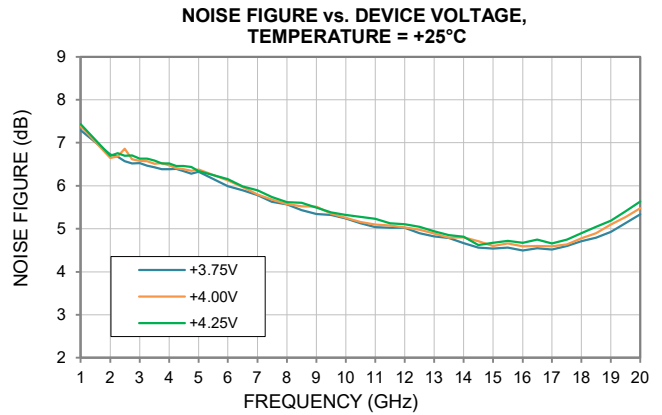
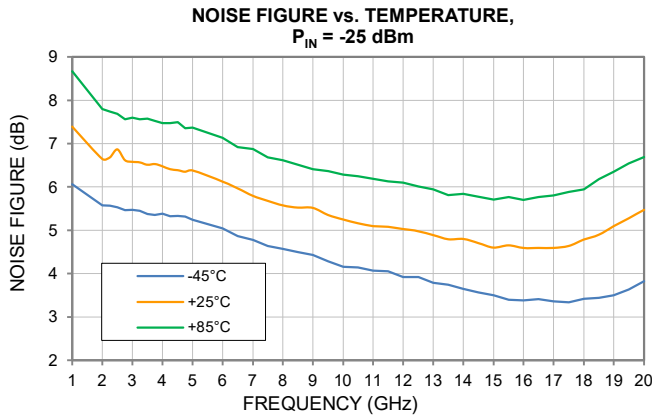

ABSOLUTE MAXIMUM RATINGS<sup>6</sup>

| Parameter  | Ratings   |
|--|---|
| Operating Temperature  | -45°C to +85°C                                  |
| Storage Temperature  | -65°C to +150°C                                 |
| Total Power Dissipation  | 1.7 W   |
| Junction Temperature <sup>7</sup>                                    | +175°C  |
| RF Input Power (CW)  | +23 dBm (5 minutes max)<br>+14 dBm (continuous) |
| DC Voltage on RF-OUT   | +7 V  |
| Current I <sub>GG</sub>  | -5 mA to 0 mA                                   |
| Current I <sub>DD</sub>  | 320 mA  |
| DC Voltage on V <sub>DD</sub> (V <sub>DD1</sub> & V <sub>DD2</sub> ) | +7 V  |
| DC Voltage on V <sub>GG</sub> (V <sub>GG1</sub> & V <sub>GG2</sub> ) | -1.5 V to -0.2 V                                |

6. Permanent damage may occur if any of these limits are exceeded. Electrical maximum ratings are not intended for continuous normal operation.

7. Peak temperature on top of the die.

## THERMAL RESISTANCE

| Parameter   | Ratings  |
|---|----------|
| Thermal Resistance ( $\Theta_{jc}$ ) <sup>8</sup> | 38.8°C/W |

8.  $\Theta_{jc}$  = (Hot Spot Temperature on Die - Temperature at Ground Lead) / Dissipated Power

## ESD RATING

|                            | Class | Voltage Range  | Reference Standard          |
|----------------------------|-------|----------------|-----------------------------|
| Human Body Model (HBM)     | 1B    | 500 to <1000 V | ANSI/ESDA/JEDEC JS-001-2017 |
| Charged Device Model (CDM) | C3    | 1000 V         | JESD22-C101F                |



ESD HANDLING PRECAUTION: This device is designed to be Class 1B for HBM. Static charges may easily produce potentials higher than this with improper handling and can discharge into DUT and damage it. As a preventive measure Industry standard ESD handling precautions should be used at all times to protect the device from ESD damage.

## MSL RATING

Moisture Sensitivity: MSL3 in accordance with IPC/JEDEC J-STD-020E/JEDEC J-STD-033C



### FUNCTIONAL DIAGRAM

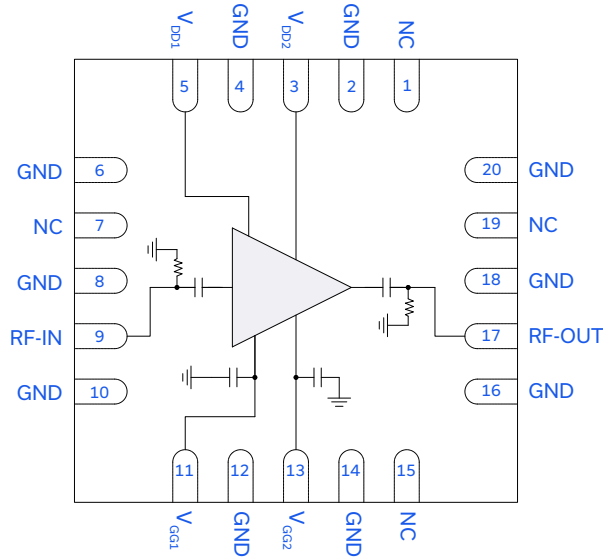

Figure 1. AVA-2183+ Functional Diagram

### PAD DESCRIPTION

| Function         | Pad Number                            | Description (Refer to Figure 2)  |
|------------------|---------------------------------------|--|
| RF-IN            | 9                                     | RF-IN Pad connects to RF-Input port. DUT includes an integrated shunt resistor for ESD protection and a DC blocking capacitor.   |
| RF-OUT           | 17                                    | RF-OUT Pad connects to RF-Output port. DUT includes an integrated shunt resistor for ESD protection and a DC blocking capacitor. |
| V <sub>DD1</sub> | 5                                     | DC Input Pad connects to voltage input port V <sub>DD1</sub> .   |
| V <sub>DD2</sub> | 3                                     | DC Input Pad connects to voltage input port V <sub>DD2</sub> .   |
| V <sub>GG1</sub> | 11                                    | DC Input Pad connects to voltage input port V <sub>GG1</sub> . DUT includes an integrated shunt capacitor.                       |
| V <sub>GG2</sub> | 13                                    | DC Input Pad connects to voltage input port V <sub>GG2</sub> . DUT includes an integrated shunt capacitor.                       |
| GND              | 2,4,6,8,10, 12,14,16,18, 20, & Paddle | Connects to ground.  |
| NC               | 1,7,15, &19                           | Not used internally. Connected to ground on test board.  |

### CHARACTERIZATION TEST BOARD

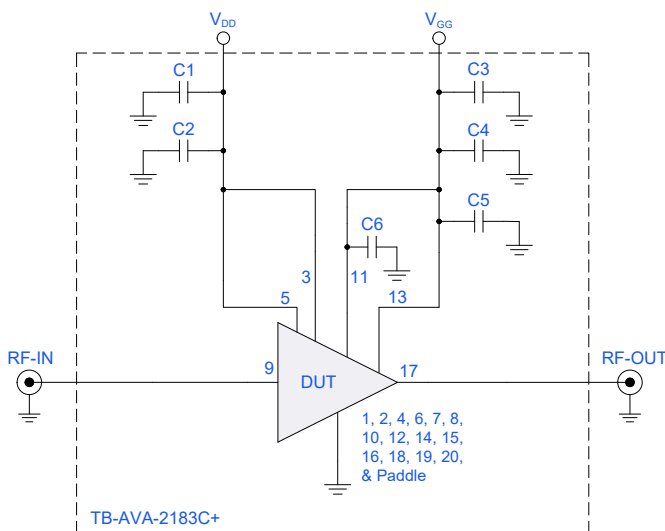

Figure 2. DUT soldered on Mini-Circuits Characterization Test Board: TB-AVA-2183C+

Gain, Return Loss, Output Power at 1 dB Compression (P1dB), Output IP3 (OIP3) and Noise Figure measured using PNA-X N5247B Microwave Network Analyzer.

Conditions:

1. Gain and Return Loss: P<sub>IN</sub> = -25 dBm
2. Output IP3 (OIP3): Two tones, spaced 1 MHz apart, 0 dBm/tone at output
3. V<sub>DD</sub> = +4 V, I<sub>DD</sub> = 210 mA

Caution: Permanent damage to the device will occur if the Power ON and Power OFF Sequences are not followed.

Power ON Sequence:

1. Set V<sub>GG</sub> = -1.3 V. Apply V<sub>GG</sub>.
2. Set V<sub>DD</sub> = +4 V. Apply V<sub>DD</sub>.
3. Increase V<sub>GG</sub> to obtain desired I<sub>DD</sub> as shown in specification table.
4. Apply RF Signal.

Power OFF Sequence:

1. Turn off RF Signal.
2. Adjust V<sub>GG</sub> down to -1.3 V.
3. Turn off V<sub>DD</sub>.
4. Turn off V<sub>GG</sub>.

| Component | Vendor  | Vendor P/N         | Value  | Size |
|-----------|---------|--------------------|--------|------|
| C1, C3    | Samsung | CL31B106KBHNNNE    | 10 μF  | 1206 |
| C2, C4    | AVX     | 06035C104KAT2A     | 0.1 μF | 0603 |
| C5, C6    | Murata  | GRM1885C1H101GA01D | 100 pF | 0603 |



### CASE STYLE DRAWING

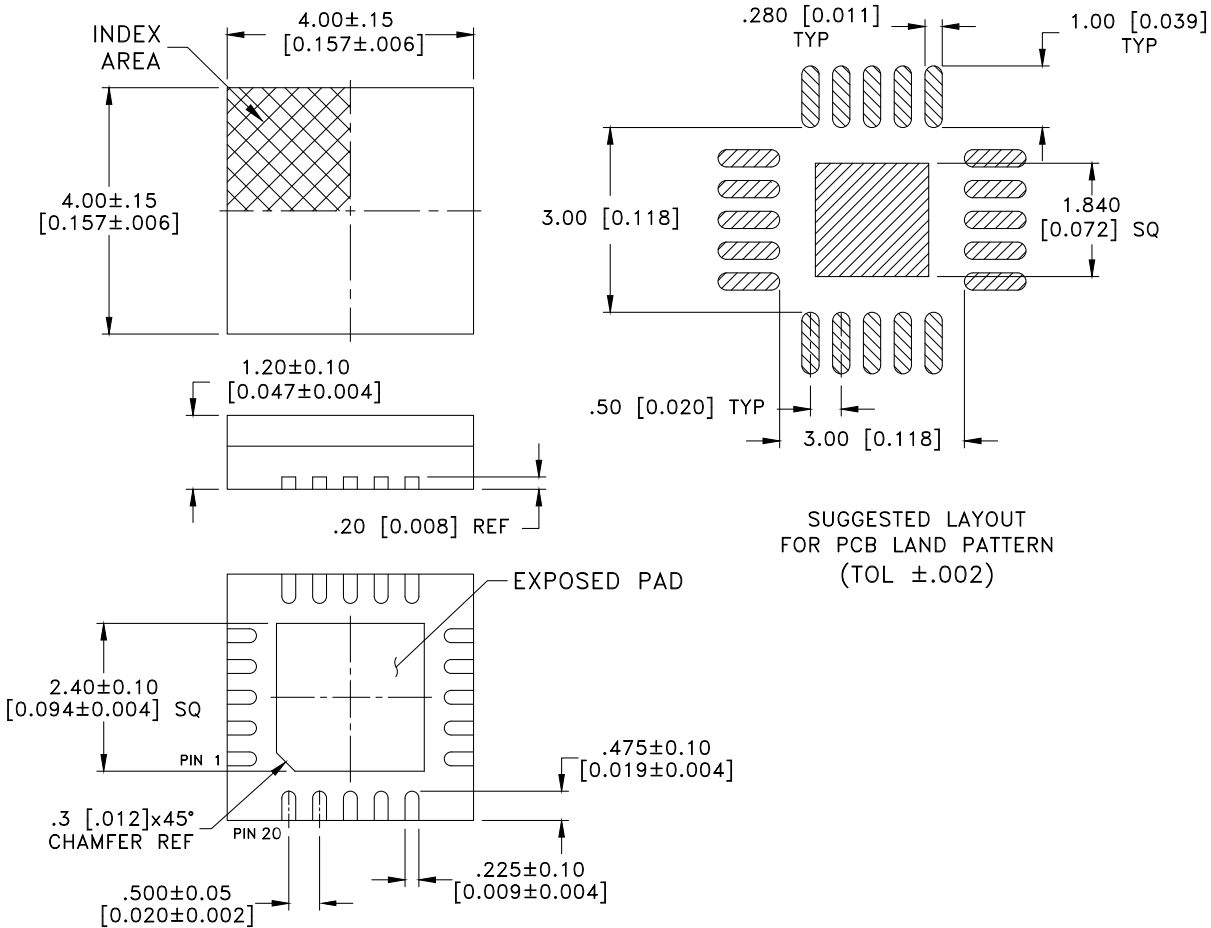

Weight: 0.1 grams  
Dimensions are in inches [mm].

Figure 3. DG1847-1 Case Style Drawing

### PRODUCT MARKING

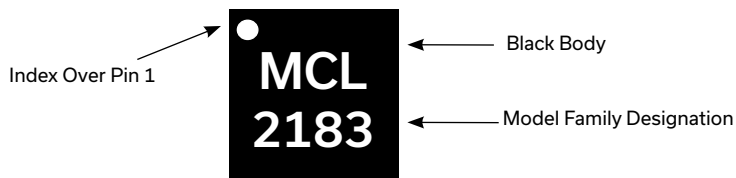

Marking may contain other features or characters for internal lot control.

Figure 4. AVA-2183+ Product Marking



MMIC SURFACE MOUNT

# Wideband Amplifier

## AVA-2183+

50Ω 2 to 20 GHz Excellent Gain Flatness

ADDITIONAL DETAILED INFORMATION IS AVAILABLE ON OUR DASHBOARD

[CLICK HERE](#)

|  |  |
|--|--|
| <b>Performance Data</b>  | Data<br>Graphs<br>S-Parameter (S2P Files) Data Set (.zip file)                               |
| <b>Case Style</b>  | DG1847-1. QFN-style package, exposed paddle, Lead Finish: PPF                                |
| <b>RoHs Status</b>   | Compliant  |
| <b>Tape &amp; Reel<br/>Standard Quantities Available on Reel</b> | F66<br>7" Reels with 20, 50, 100, 200, 500, 1000, 2000, or 3000 devices                      |
| <b>Suggested Layout for PCB Design</b>                           | PL-742   |
| <b>Evaluation Board</b>  | TB-AVA-2183C+<br>Gerber File   |
| <b>Environmental Ratings</b>                                     | ENV08T10   |
| <b>Product Handling</b>  | The use of no-clean solder is recommended. This package cannot be subjected to aqueous wash. |

### NOTES

- A. Performance and quality attributes and conditions not expressly stated in this specification document are intended to be excluded and do not form a part of this specification document.
- B. Electrical specifications and performance data contained in this specification document are based on Mini-Circuit's applicable established test performance criteria and measurement instructions.
- C. The parts covered by this specification document are subject to Mini-Circuits standard limited warranty and terms and conditions (collectively, "Standard Terms"); Purchasers of this part are entitled to the rights and benefits contained therein. For a full statement of the standard terms and the exclusive rights and remedies thereunder, please visit Mini-Circuits' website at [www.minicircuits.com/terms/viewterm.html](http://www.minicircuits.com/terms/viewterm.html)



## Looking for pricing, stock, or lifecycle information?

Click below to explore more details on WIN SOURCE:

 [View AVA-2183+](#) on WIN SOURCE

 [Mini-Circuits](#) Information

## Optimize Your Supply Chain with WIN SOURCE Solutions

-  Global Sourcing Solution
-  Obsolete Management
-  Cost Control Management
-  Shortage Management
-  Alternative Solution
-  Excess Inventory Management