



THE DATASHEET OF PVGA-123+





MMIC SURFACE MOUNT

Variable Gain Amplifier

PVGA-123+

Mini-Circuits

50Ω 0.4 to 12 GHz

THE BIG DEAL

- Wide Bandwidth 0.4 to 12 GHz
- High OIP3 Typ. +30 dBm
- Single Positive Supply +6 V
- Adjustable Gain Range Typ. 16 dB
- 3x3mm 12-Lead QFN-Style Package

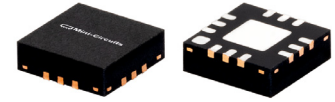

Generic photo used for illustration purposes only

APPLICATIONS

- Radar, EW, and ECM Defense Systems
- 5G MIMO and Back Haul Radio Systems
- Test and Measurement Equipment

FUNCTIONAL DIAGRAM

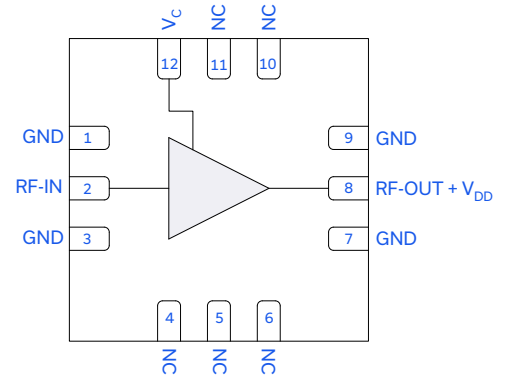

PRODUCT OVERVIEW

The PVGA-123+ is a GaAs pHEMT high performance variable gain amplifier operating from 0.4 to 12 GHz. The amplifier provides 16 dB Gain, +30 dBm OIP3 and +22 dBm P1dB with 17 dB typical return loss while operating from +6 V and 77 mA DC power. The amplifier gain is voltage adjustable over a 16 dB dynamic range while maintaining excellent input IP3. The amplifier is ideal for use in very wideband ECM, Test and Measurement and Back Haul Radio systems.

KEY FEATURES

Features	Advantages
Wideband: 0.4 to 12 GHz <ul style="list-style-type: none"> • 16 dB Typ. Gain at 6 GHz • 13 dB Typ. Gain at 12 GHz 	Suitable for wide bandwidth defense and test and measurement application as well as narrow band performance driven applications
High P1dB & OIP3 <ul style="list-style-type: none"> • +22 dBm Typ. P1dB • +30 dBm Typ. OIP3 	Suitable as a driver amplifier in receiver/transmitter chains.
Adjustable Gain Range <ul style="list-style-type: none"> • 16 dB 	Enables temperature compensation and power control for transmit and receive signal chains
3x3mm 12-Lead QFN-style package	Small footprint saves space in dense layouts while providing low inductance, repeatable transitions, and excellent thermal contact to the PCB.



MMIC SURFACE MOUNT

Variable Gain Amplifier

PVGA-123+

50Ω 0.4 to 12 GHz

ELECTRICAL SPECIFICATIONS¹ AT +25°C, V_c = +5 V, UNLESS NOTED OTHERWISE

Parameter	Condition (GHz)	V _{DD} = +6 V			V _{DD} = +5 V			Units
		Min.	Typ.	Max.	Min.	Typ.	Max.	
Frequency Range		0.4		12	0.4		12	GHz
Gain	0.4	15.2	16.8			18.9		dB
	4	15.0	16.9			18.7		
	6	14.3	16.3			18.0		
	8	13.8	15.7			17.8		
	12	10.9	12.9			16.9		
Output Power at 1 dB Compression (P1dB)	0.4		+20.9			+18.9		dBm
	4		+20.7			+18.7		
	6		+19.9			+18.0		
	8		+19.7			+17.8		
	12		+18.9			+16.9		
Output Power at 3 dB Compression (P3dB) ²	0.4		+21.9			+20.0		dBm
	4		+21.7			+19.9		
	6		+21.4			+19.2		
	8		+21.2			+19.2		
	12		+19.6			+17.7		
Output Third-Order Intercept P _{OUT} = -5 dBm/Tone	0.4		+27			+26		dBm
	4		+33			+33		
	6		+30			+30		
	8		+28			+27		
	12		+28			+27		
Input Return Loss	0.4	13	18			18		dB
	4	14	19			19		
	6	12	17			17		
	8	10	13			14		
	12	8	11			11		
Output Return Loss	0.4	12	18			18		dB
	4	12	18			17		
	6	10	14			13		
	8	11	16			16		
	12	7	11			10		
Isolation	0.4		26			26		dB
	4		27			27		
	6		29			29		
	8		29			29		
	12		29			29		
Noise Figure	0.4		5.4			5.7		dB
	4		4.3			4.3		
	6		4.2			4.3		
	8		4.3			4.3		
	12		4.5			4.5		
Device Operating Voltage (V _{DD})			+6			+5		V
Device Operating Current (I _{DD}) ³			77			73		mA
DC Current Variation vs. Temperature ⁴			26.9			42.5		μA/°C
DC Current Variation vs. Voltage ⁵			0.004					mA/mV

1. Tested in Mini-Circuits Evaluation Board TB-PVGA-123C+. See Figure 2. Board loss de-embedded to the device.

2. Defined as Output Power at which gain is compressed 3dB.

3. Current at P_{IN} = -25 dBm.

4. ((Current at +85°C - Current at -45°C)/(+130°C)

5. ((Current at +6V in mA) - (Current at +5V mA))/((+6V - +5V)*1000)





MMIC SURFACE MOUNT

Variable Gain Amplifier

PVGA-123+

50Ω 0.4 to 12 GHz

ELECTRICAL SPECIFICATIONS⁶ OVER VARIOUS V_C AT +25°C, $V_{DD} = +6$ V, UNLESS NOTED OTHERWISE

Parameter	Frequency (GHz)	Control Voltage, V_C						Units
		+0.8 V	+1 V	+2 V	+3 V	+4 V	+5 V	
DC Current, Typ.	-	3	11	30	43	59	77	mA
Gain, Typ.	0.4	5.6	8.3	11.1	14.5	16.1	16.8	dB
	4	3.2	7.1	10.7	14.4	16.1	16.9	
	6	-0.1	4.9	9.2	13.4	15.4	16.3	
	8	-1.7	3.8	8.7	12.9	14.8	15.7	
	12	-4.5	1.5	7.1	10.9	12.3	12.9	
Isolation, Typ.	0.4	18	19	21	23	25	26	dB
	4	20	21	22	25	26	27	
	6	23	23	24	26	28	29	
	8	24	24	24	26	28	29	
	12	25	24	24	26	28	29	
Input Return Loss, Typ.	0.4	8	10	16	27	21	18	dB
	4	10	12	18	25	21	19	
	6	9	10	13	15	16	17	
	8	11	11	12	13	13	13	
	12	13	13	12	12	11	11	
Output Return Loss, Typ.	0.4	5	6	10	22	27	18	dB
	4	5	7	9	16	19	18	
	6	4	5	7	10	12	14	
	8	5	6	8	11	14	16	
	12	7	7	9	11	11	11	
Output Power at 1 dB Compression (P1dB), Typ.	0.4	+21.8	+21.8	+22.0	+21.7	+21.1	+20.9	dBm
	4	+21.4	+21.4	+21.4	+21.2	+20.9	+20.7	
	6	+20.9	+21.1	+20.9	+20.5	+20.2	+19.9	
	8	+20.8	+21.1	+21.4	+20.8	+20.1	+19.7	
	12	+19.9	+20.5	+20.6	+18.9	+18.8	+18.9	
Output Power at 3 dB Compression (P3dB) ⁷ , Typ.	0.4	+21.8	+21.8	+22.1	+22.3	+22.1	+21.9	dBm
	4	+21.5	+21.4	+21.6	+21.7	+21.8	+21.7	
	6	+20.8	+21.0	+21.3	+21.4	+21.4	+21.4	
	8	+20.6	+21.0	+21.5	+21.5	+21.3	+21.2	
	12	+19.9	+20.2	+20.8	+19.5	+19.5	+19.6	
Output Third-Order Intercept, Typ. ($P_{OUT} = -5$ dBm/Tone)	0.4	+10	+13	+12	+20	+26	+27	dBm
	4	+9	+14	+13	+23	+30	+33	
	6	+8	+17	+13	+24	+27	+30	
	8	+8	+19	+12	+23	+26	+28	
	12	+7	+14	+13	+22	+26	+28	
Noise Figure, Typ.	0.4	9.7	9.1	7.5	6.1	5.6	5.4	dB
	4	6.3	5.4	5.0	4.4	4.3	4.3	
	6	7.3	5.6	5.0	4.4	4.2	4.2	
	8	7.5	5.6	4.9	4.4	4.2	4.3	
	12	9.5	6.6	5.3	4.6	4.5	4.5	

6. Tested in Mini-Circuits Characterization Test/Evaluation Board TB-PVGA-123C+. See Figure 2. Board loss de-embedded to the device.

7. Defined as Output Power at which gain is compressed 3dB.



MMIC SURFACE MOUNT

Variable Gain Amplifier

PVGA-123+

Mini-Circuits

50Ω 0.4 to 12 GHz

ELECTRICAL SPECIFICATIONS⁸ OVER VARIOUS V_C AT +25°C, V_{DD} = +5 V, UNLESS NOTED OTHERWISE

Parameter	Frequency (GHz)	Control Voltage, V _C						Units
		+0.8 V	+1 V	+2 V	+3 V	+4V	+ 5V	
DC Current, Typ.	-	2	10	29	41	56	73	mA
Gain, Typ.	0.4	4.9	8.2	10.6	14.5	15.8	16.6	dB
	4	2.1	7.0	10.2	14.4	15.8	16.7	
	6	-1.3	4.7	8.6	13.5	15.1	16.1	
	8	-3.0	3.6	8.1	13.0	14.5	15.5	
	12	-5.7	1.3	6.4	10.8	12.0	12.8	
Isolation, Typ.	0.4	18	19	21	23	25	26	dB
	4	20	21	23	25	27	27	
	6	23	23	24	26	28	29	
	8	24	24	24	26	28	29	
	12	25	24	24	27	28	29	
Input Return Loss, Typ.	0.4	8	10	16	26	22	18	dB
	4	10	12	17	25	22	19	
	6	9	10	12	15	16	17	
	8	11	11	12	13	13	14	
	12	13	13	13	12	12	11	
Output Return Loss, Typ.	0.4	5	6	9	19	32	18	dB
	4	5	7	9	15	18	17	
	6	4	5	6	9	12	13	
	8	5	6	7	11	14	16	
	12	6	7	9	11	11	10	
Output Power at 1 dB Compression (P1dB), Typ.	0.4	+19.3	+19.5	+19.9	+19.7	+19.2	+18.9	dBm
	4	+19.2	+19.4	+19.5	+19.0	+18.7	+18.7	
	6	+19.0	+19.2	+18.6	+18.1	+18.0	+18.0	
	8	+19.5	+19.5	+19.5	+18.7	+18.1	+17.8	
	12	+18.6	+19.2	+18.8	+17.1	+16.8	+16.9	
Output Power at 3 dB Compression (P3dB) ⁹ , Typ.	0.4	+19.3	+19.3	+20.0	+20.3	+20.2	+20.0	dBm
	4	+19.2	+19.2	+19.7	+19.9	+20.0	+19.9	
	6	+19.1	+19.1	+19.5	+19.5	+19.4	+19.2	
	8	+19.3	+19.5	+19.8	+19.7	+19.4	+19.2	
	12	+18.6	+19.0	+19.1	+17.7	+17.6	+17.7	
Output Third-Order Intercept, Typ. (P _{OUT} = -5 dBm/Tone)	0.4	+9	+13	+11	+19	+24	+26	dBm
	4	+8	+14	+13	+21	+29	+33	
	6	+7	+17	+12	+22	+27	+30	
	8	+7	+19	+12	+21	+25	+27	
	12	+6	+14	+12	+20	+25	+27	
Noise Figure, Typ.	0.4	9.8	9.6	7.9	6.3	6.0	5.7	dB
	4	6.8	5.4	5.1	4.5	4.3	4.3	
	6	8.1	5.7	5.1	4.5	4.3	4.3	
	8	8.2	5.7	5.0	4.4	4.3	4.3	
	12	10.3	6.8	5.4	4.7	4.5	4.5	

8. Tested in Mini-Circuits Evaluation Board TB-PVGA-123C+. See Figure 2. Board loss de-embedded to the device.

9. Defined as Output Power at which gain is compressed 3dB.



TYPICAL PERFORMANCE GRAPHS

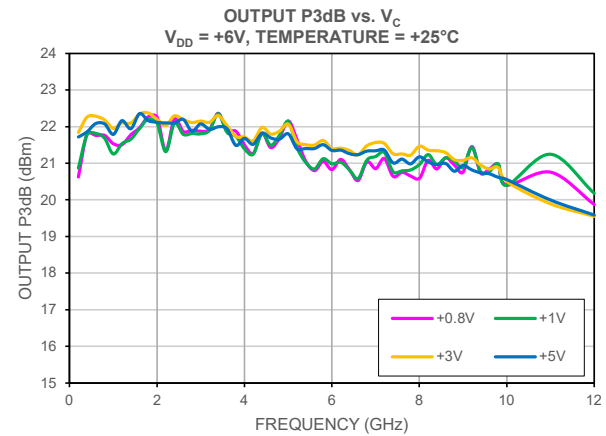
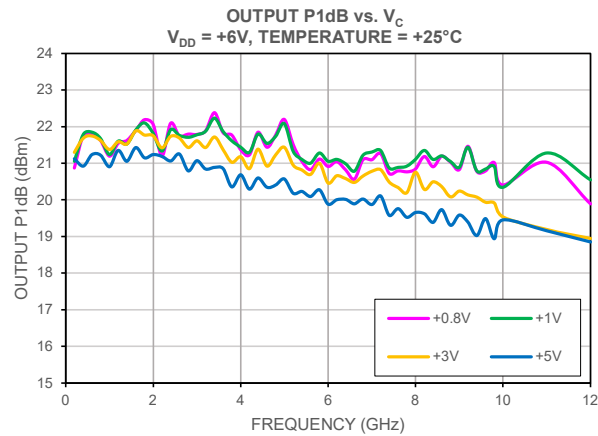
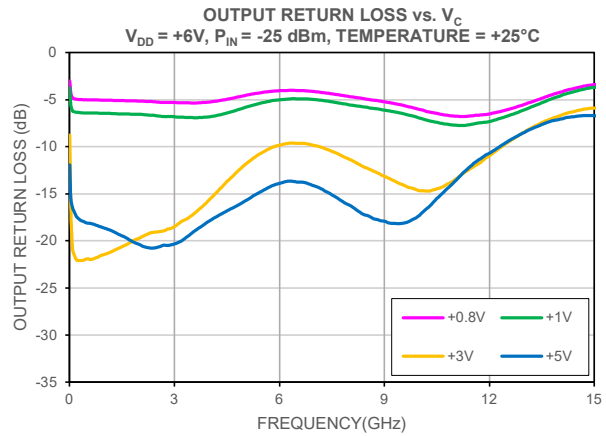
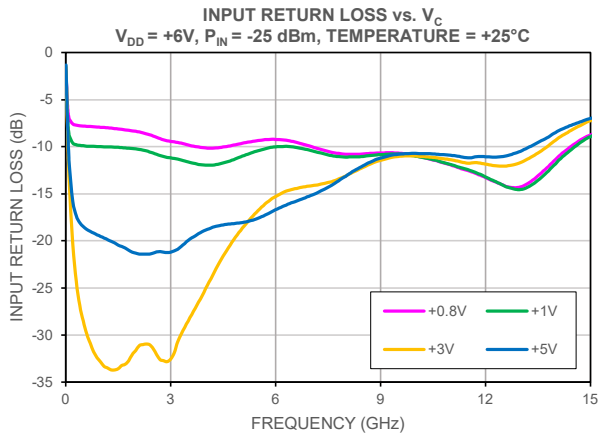
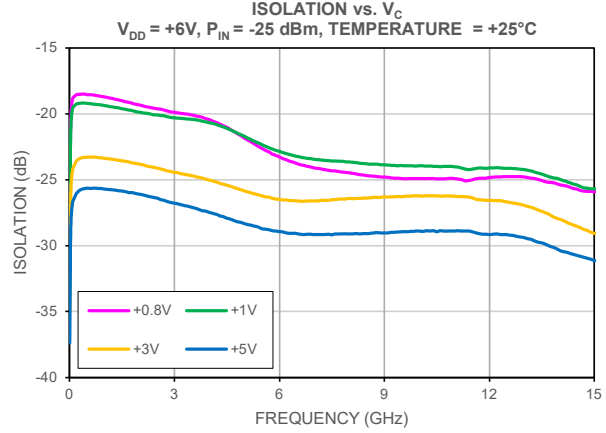
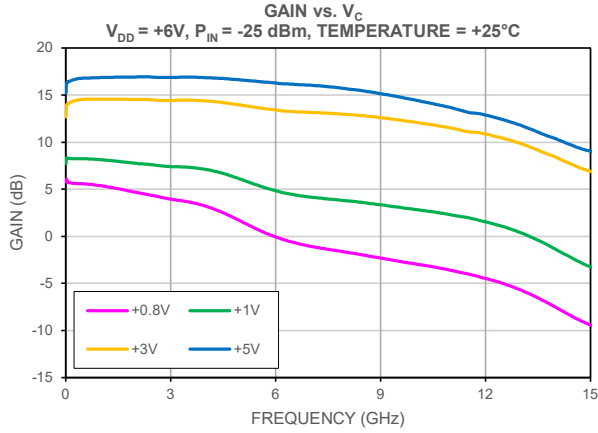



TYPICAL PERFORMANCE GRAPHS

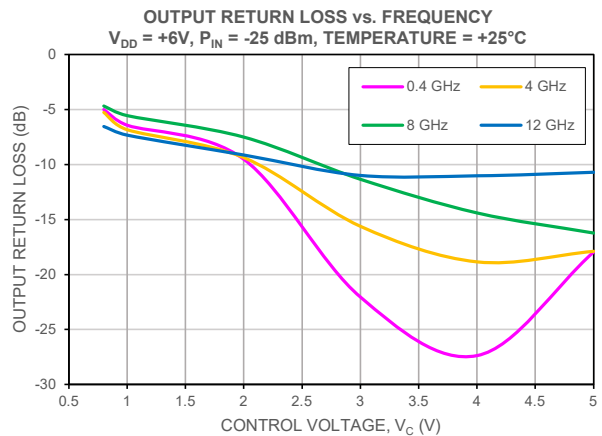
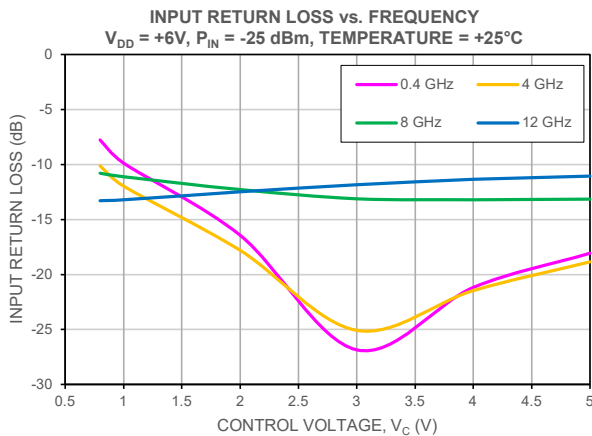
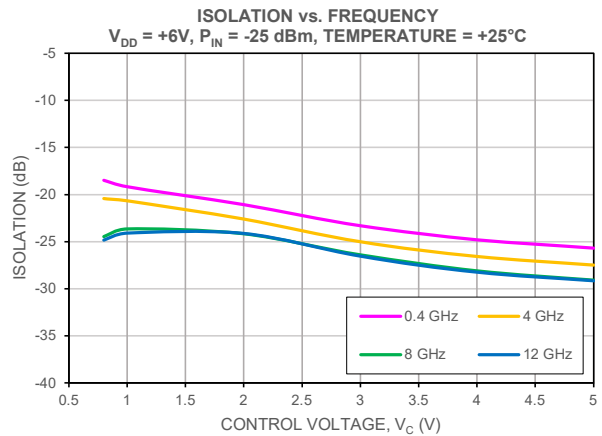
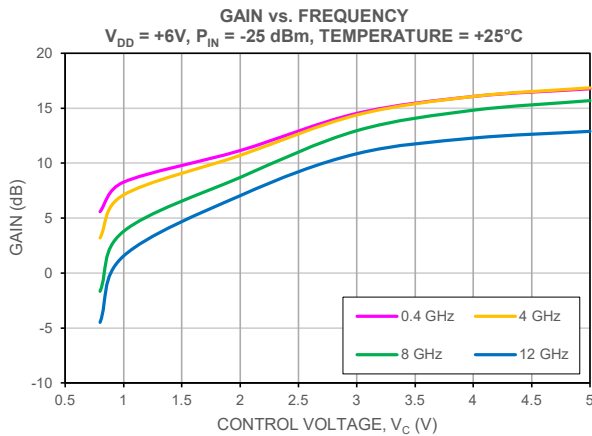
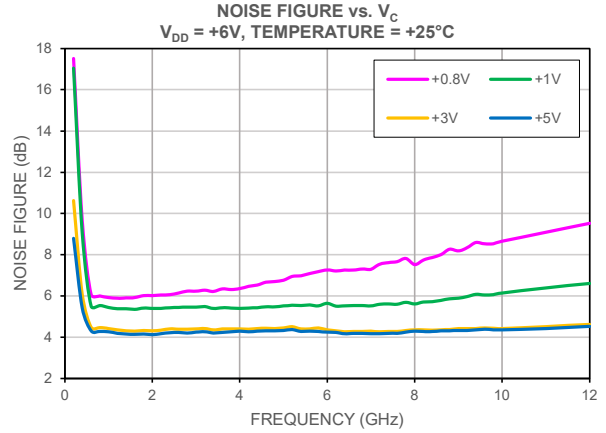
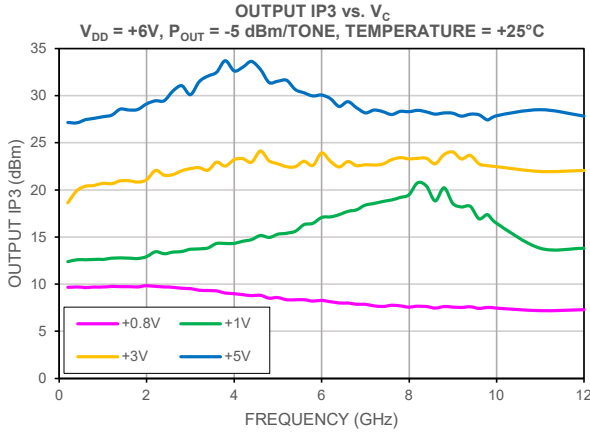



TYPICAL PERFORMANCE GRAPHS

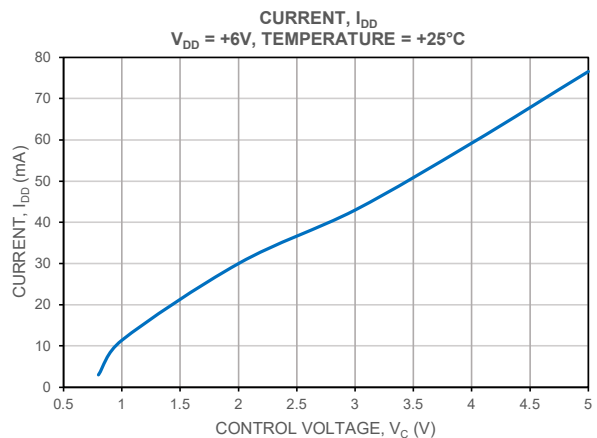
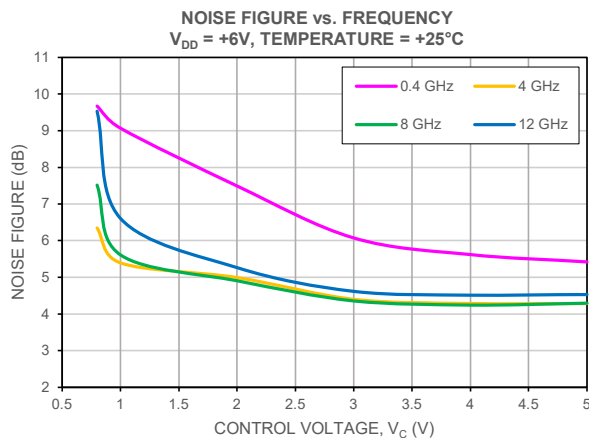
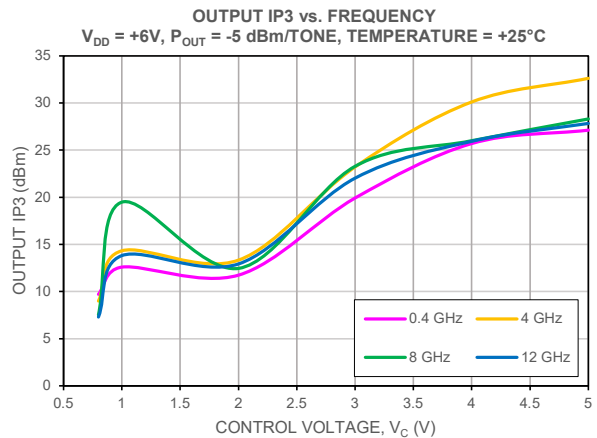
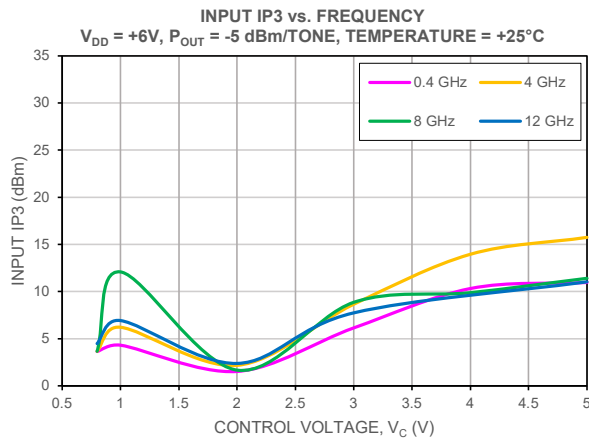
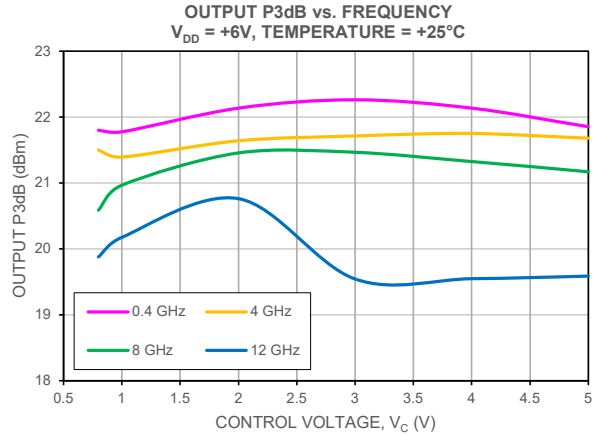
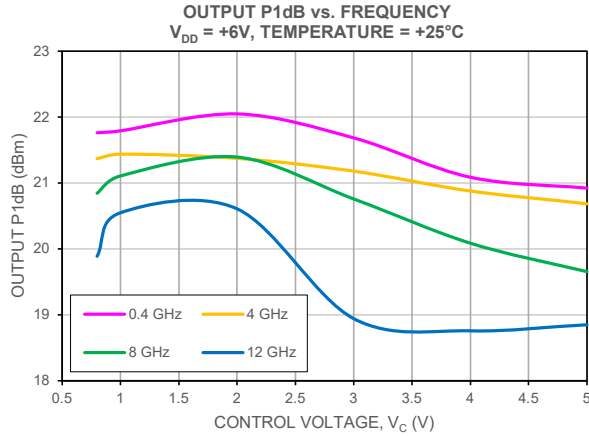



TYPICAL PERFORMANCE GRAPHS

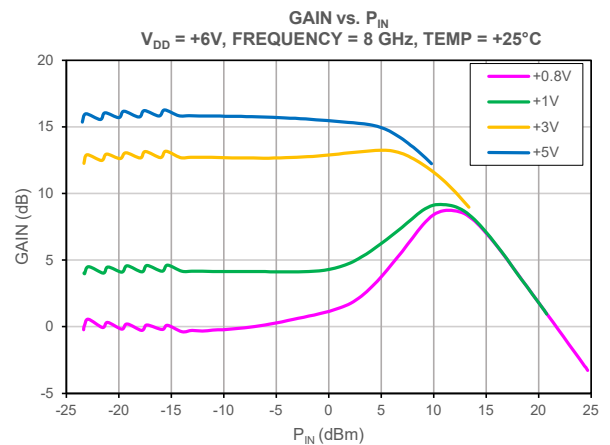
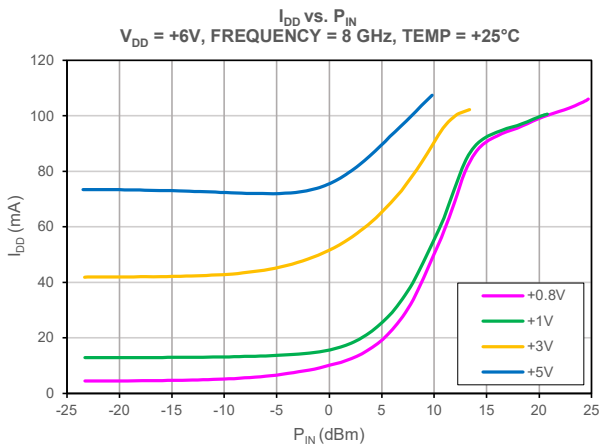
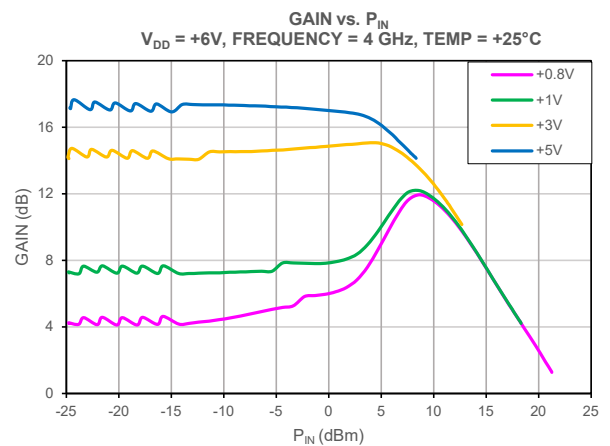
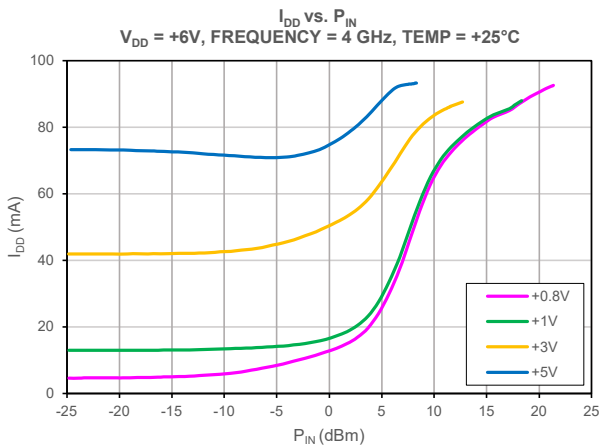
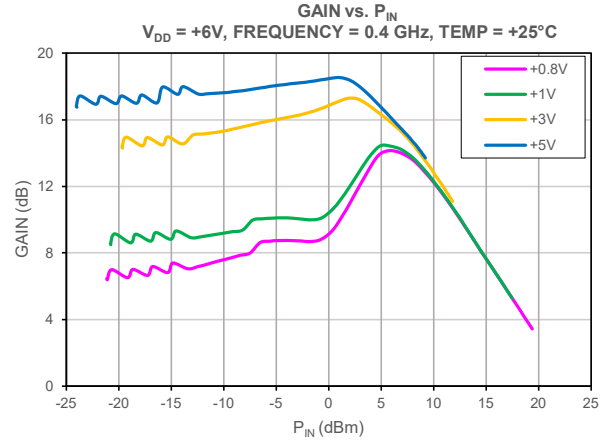
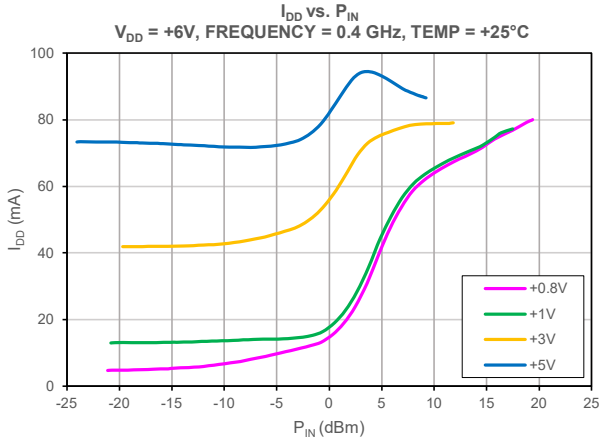



MMIC SURFACE MOUNT

Variable Gain Amplifier

PVGA-123+

Mini-Circuits

50Ω 0.4 to 12 GHz

TYPICAL PERFORMANCE GRAPHS

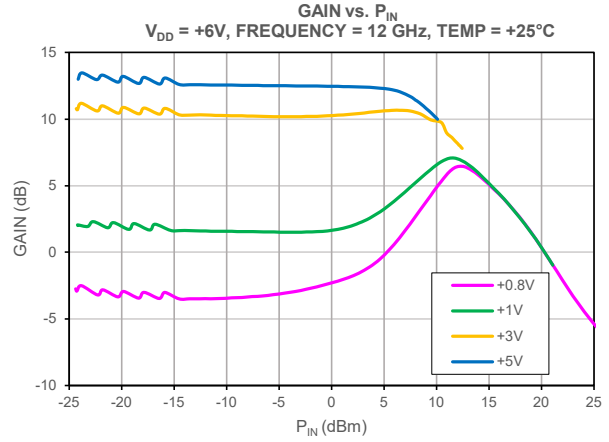
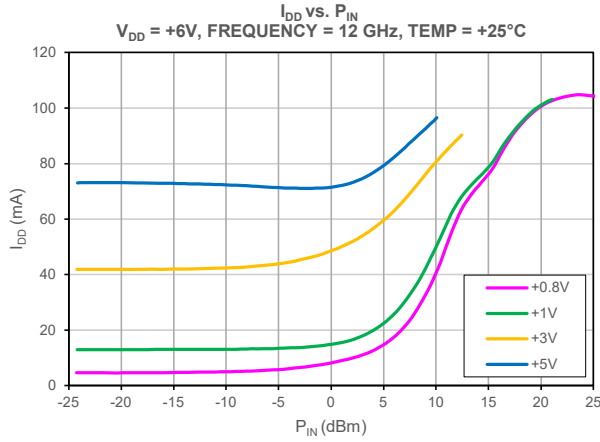



TYPICAL PERFORMANCE GRAPHS

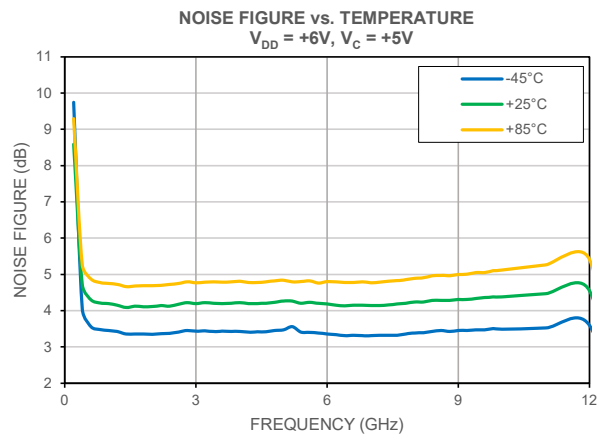
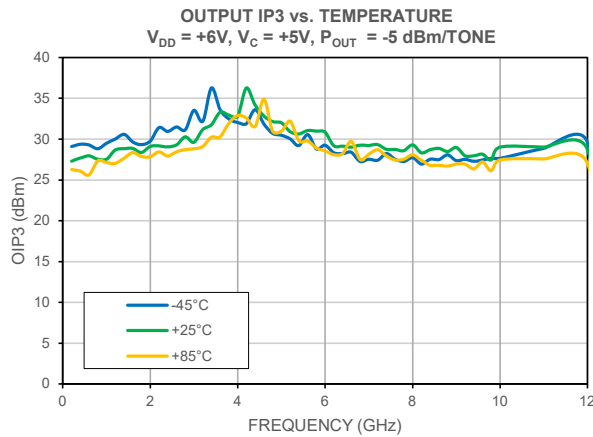
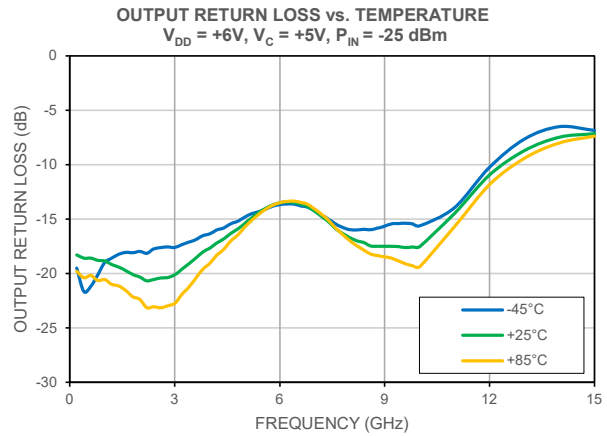
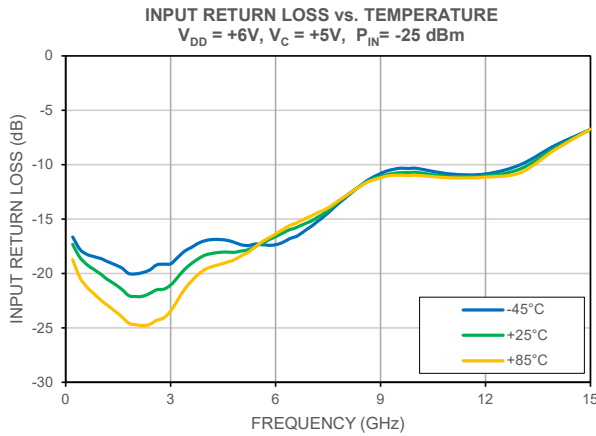
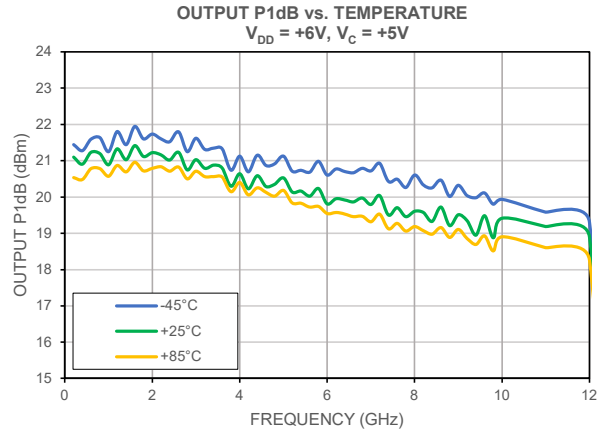
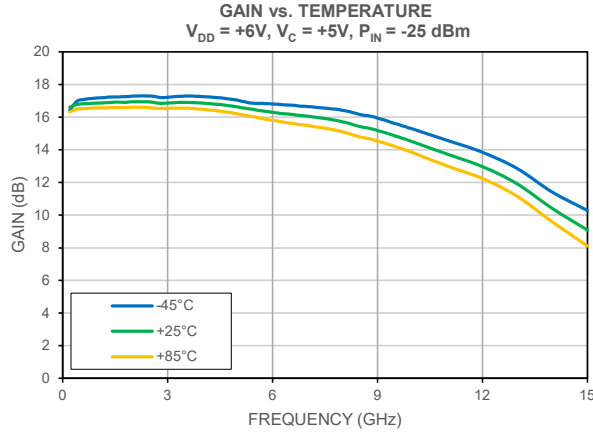



TYPICAL PERFORMANCE GRAPHS

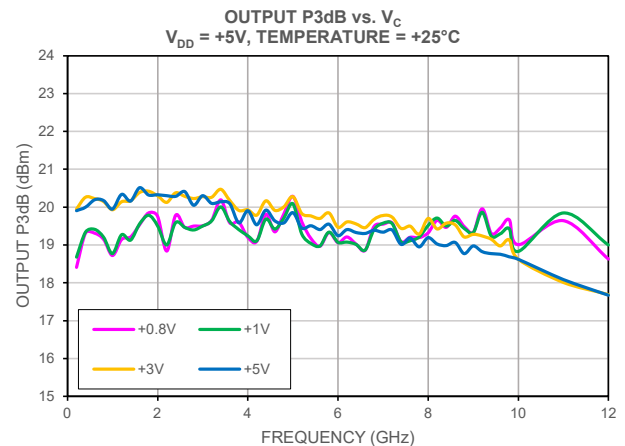
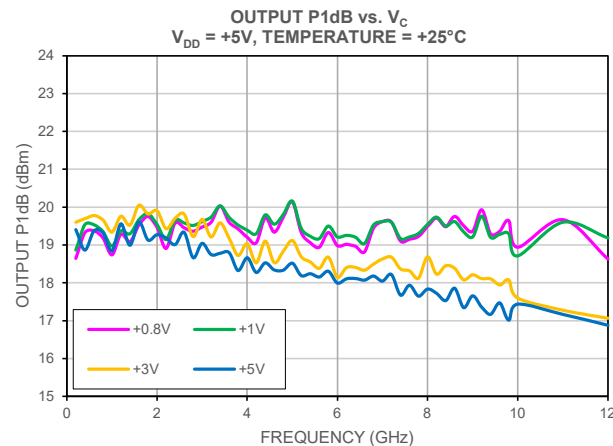
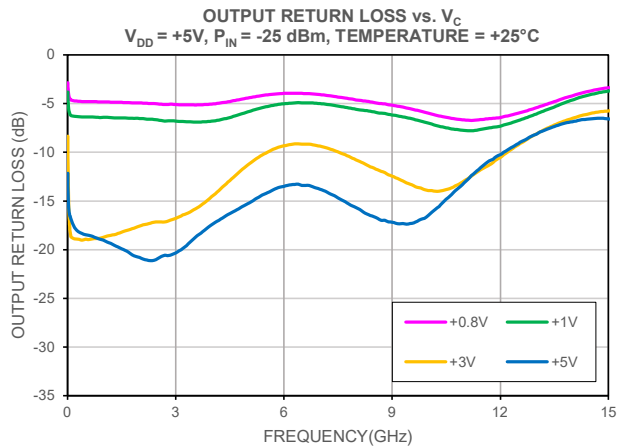
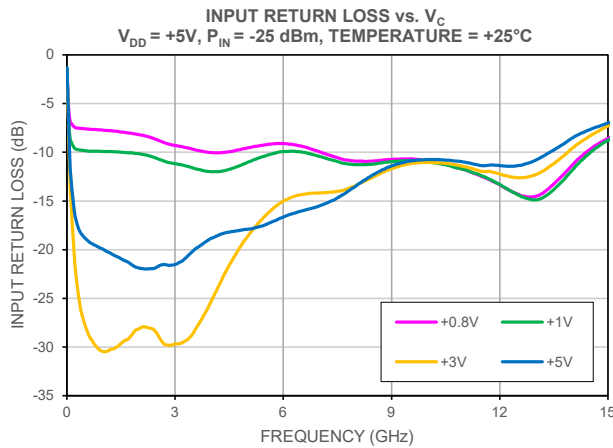
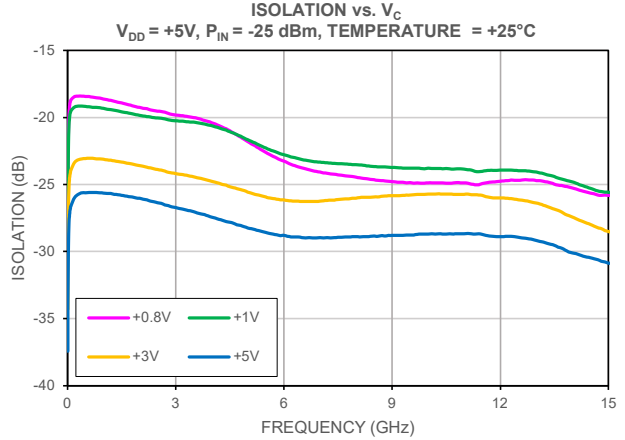
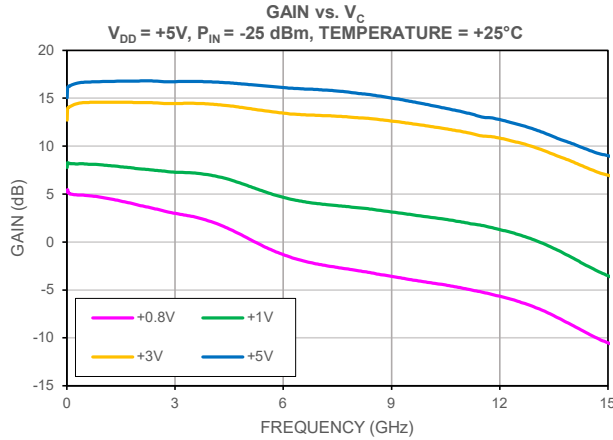



TYPICAL PERFORMANCE GRAPHS

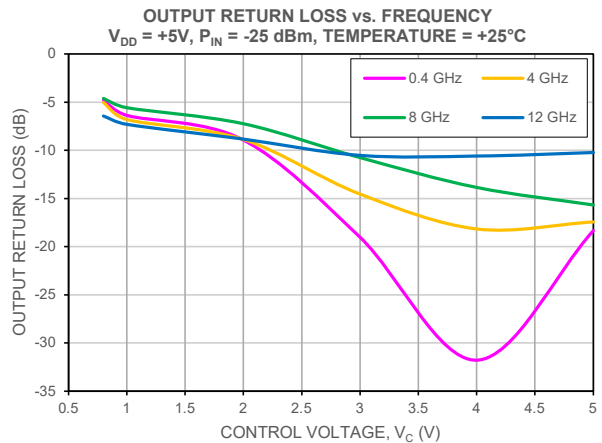
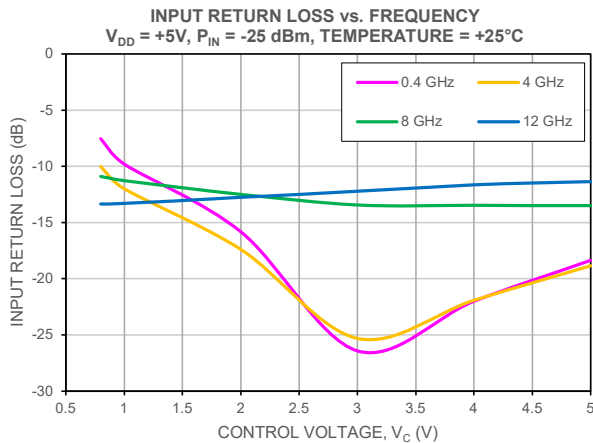
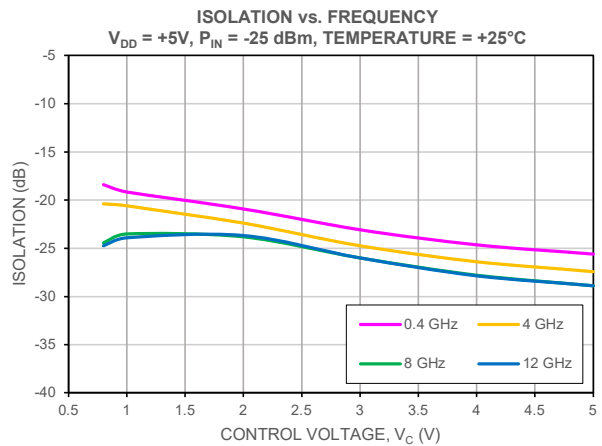
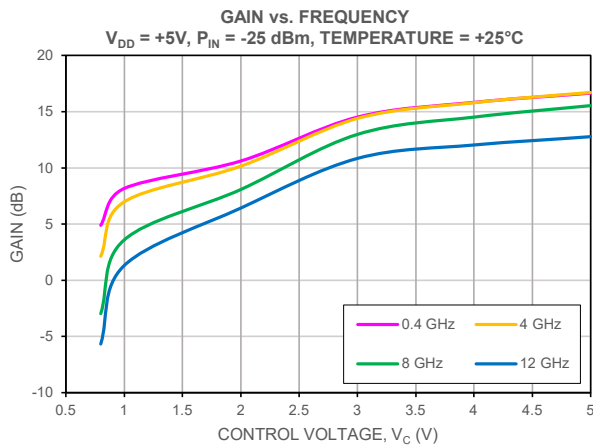
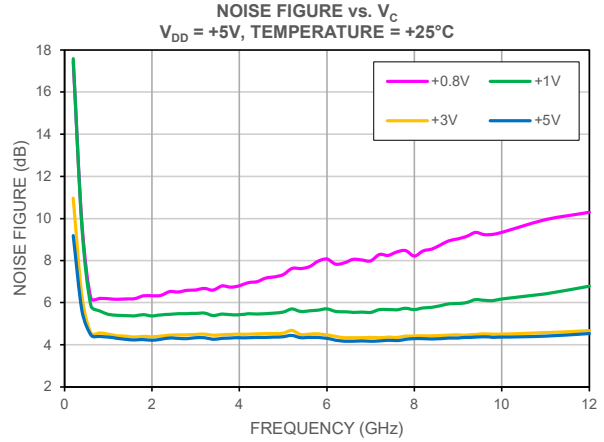
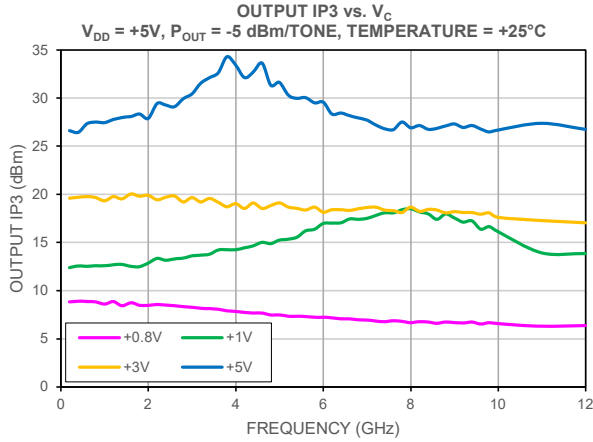



TYPICAL PERFORMANCE GRAPHS

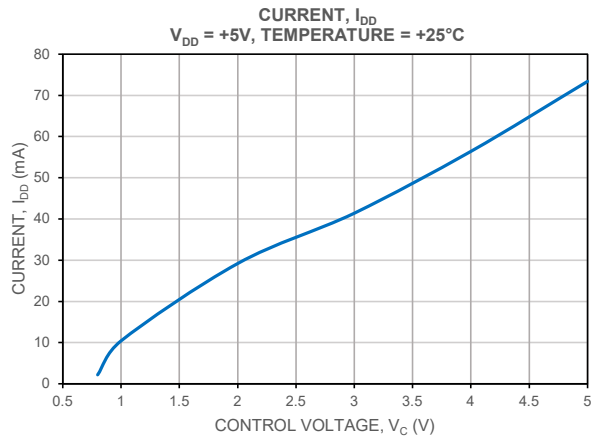
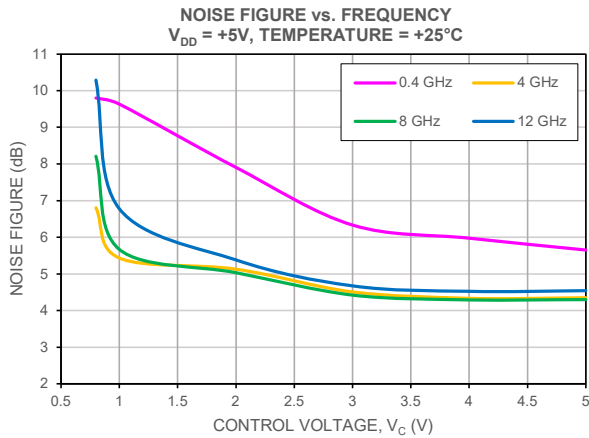
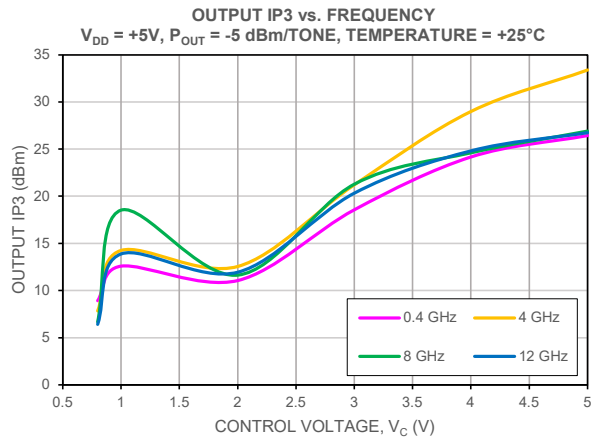
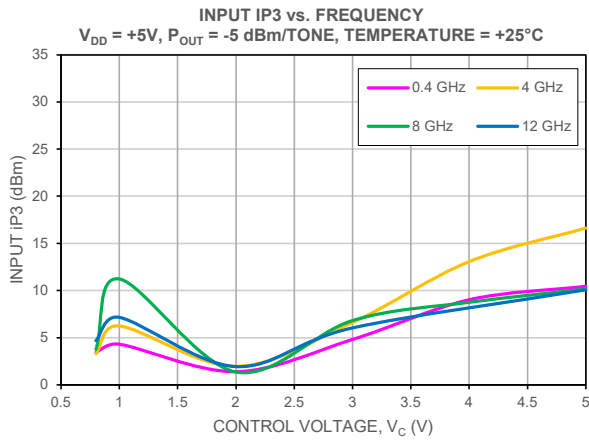
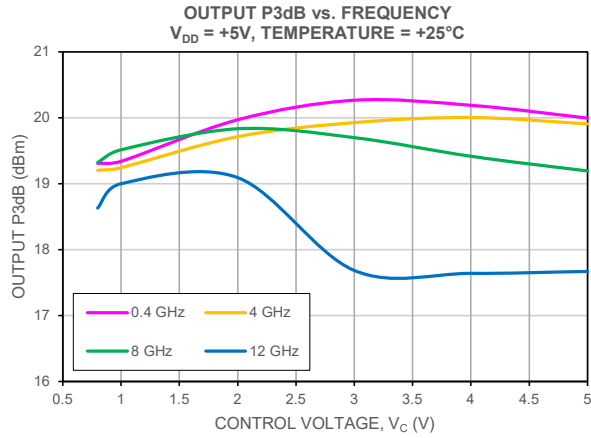
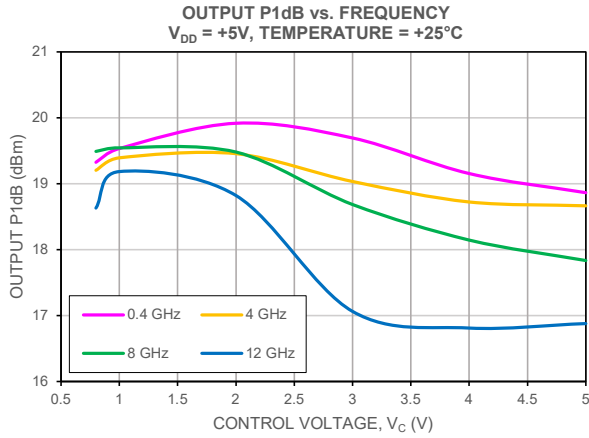



MMIC SURFACE MOUNT

Variable Gain Amplifier

PVGA-123+

Mini-Circuits

50Ω 0.4 to 12 GHz

TYPICAL PERFORMANCE GRAPHS

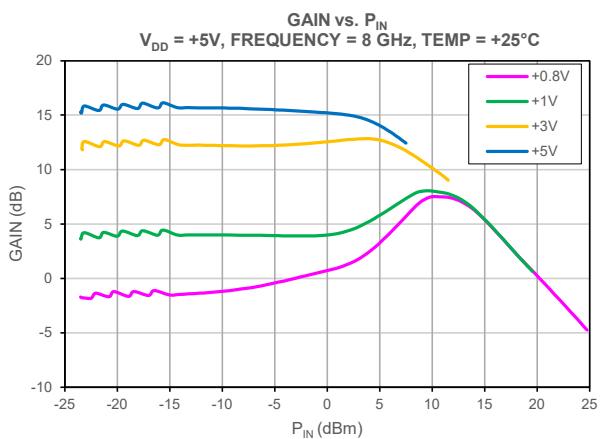
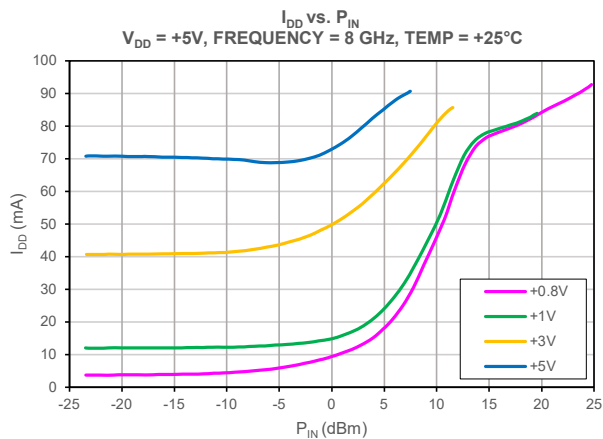
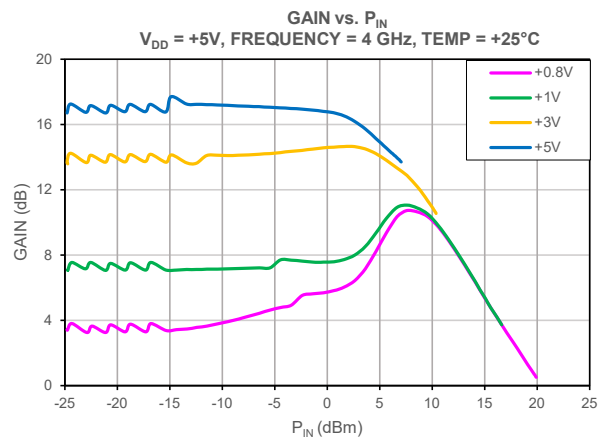
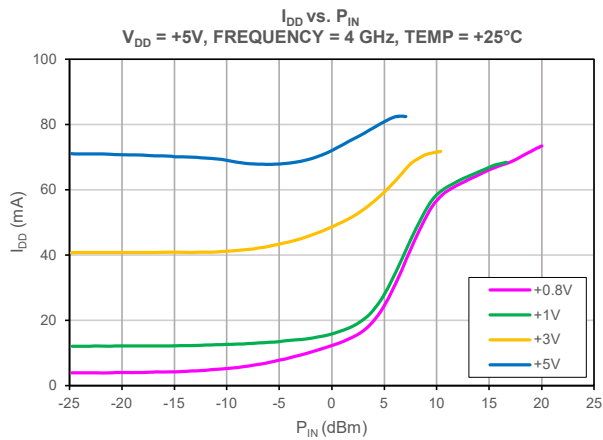
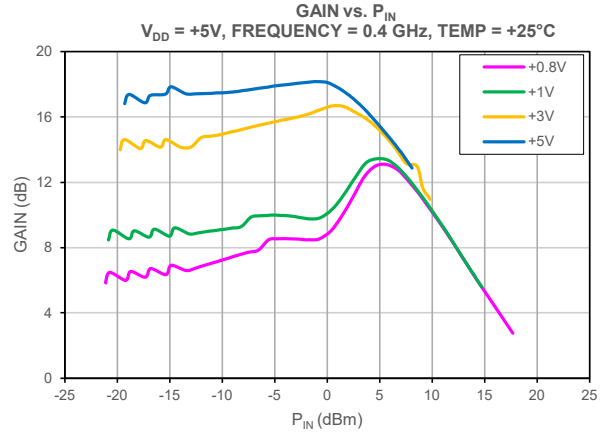
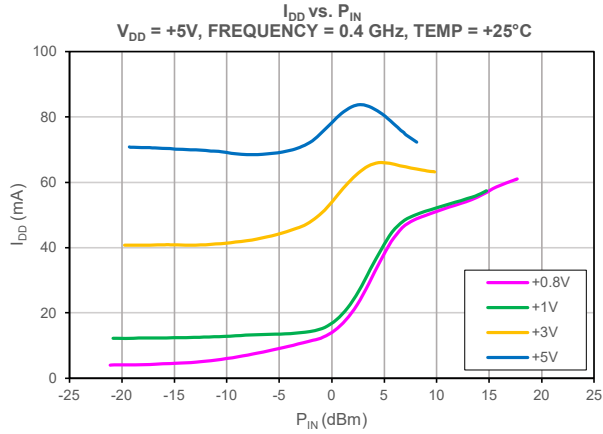



MMIC SURFACE MOUNT

Variable Gain Amplifier

PVGA-123+

Mini-Circuits

50Ω 0.4 to 12 GHz

TYPICAL PERFORMANCE GRAPHS

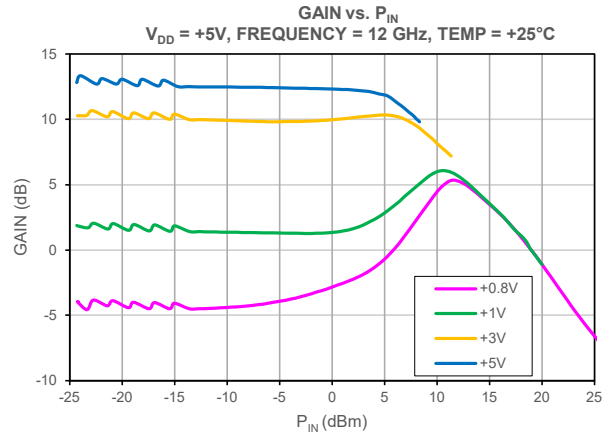
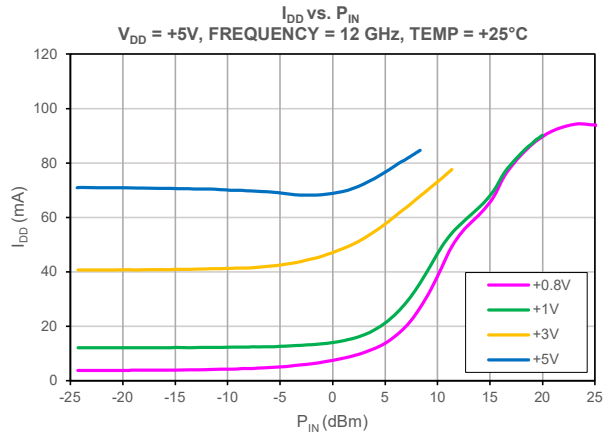



TYPICAL PERFORMANCE GRAPHS

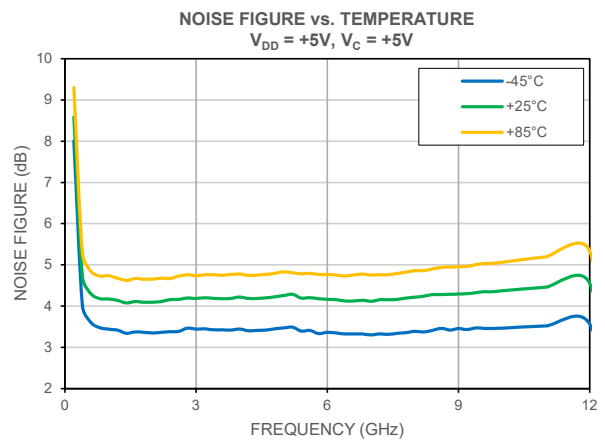
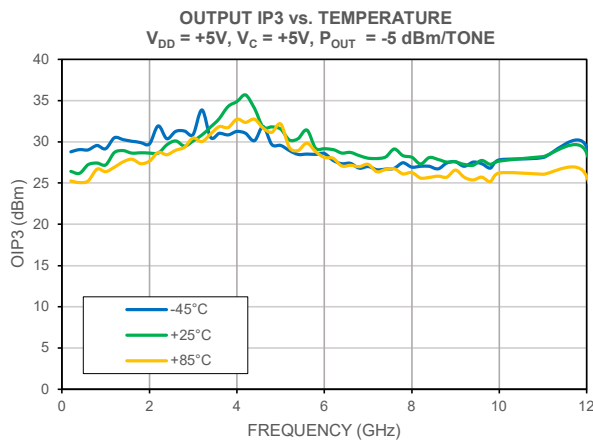
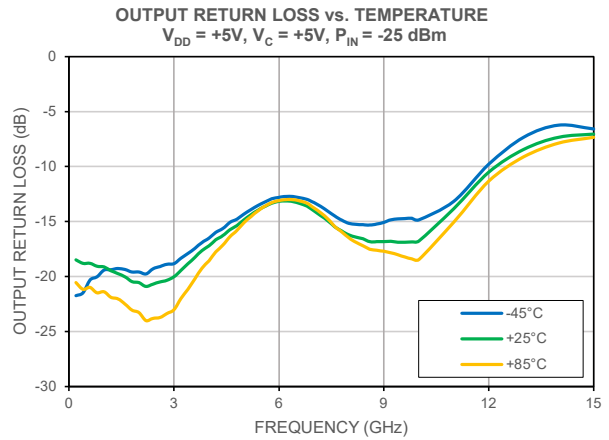
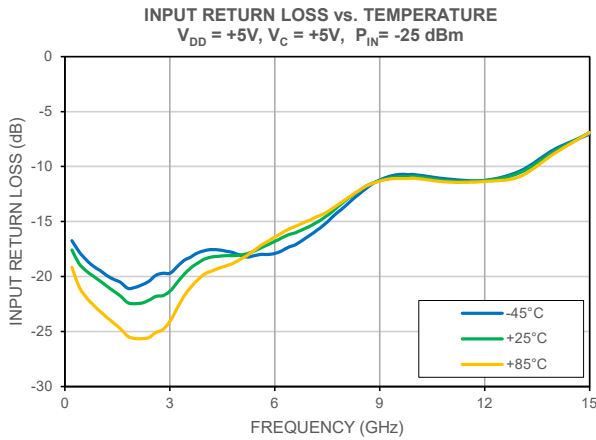
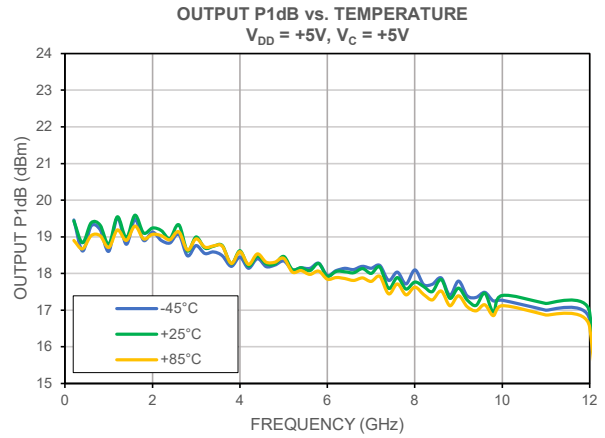
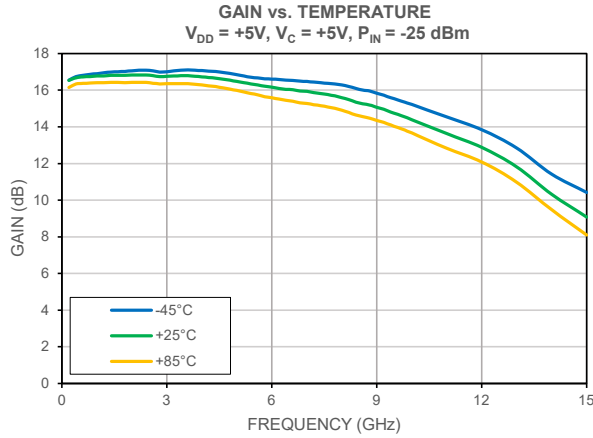



MMIC SURFACE MOUNT

Variable Gain Amplifier

PVGA-123+

50Ω 0.4 to 12 GHz

ABSOLUTE MAXIMUM RATINGS¹⁰

Parameter	Ratings
Operating Temperature (ground lead)	-45°C to +85°C
Storage Temperature	-65°C to +150°C
Junction Temperature ¹¹	+175°C
Total Power Dissipation	1.5 W
Input Power (CW), $V_{DD} = +6\text{ V}$, $V_C = +5\text{ V}$	+23 dBm
DC Voltage at V_{DD} Pad	+10.5 V
DC Voltage at V_C Pad	+10.5 V

10. Permanent damage may occur if any of these limits are exceeded. Maximum ratings are not intended for continuous normal operation.

11. Peak temperature on top of Die.

THERMAL RESISTANCE

Parameter	Ratings
Thermal Resistance (θ_{JC}) ¹²	53.2 °C/W

12. $\theta_{JC} = (\text{Hot Spot Temperature on Die} - \text{Temperature at Ground Lead}) / \text{Dissipated Power}$

ESD RATING

	Class	Voltage Range	Reference Standard
Human Body Model (HBM)	1A	250 to <500 V	ANSI/ESDA/JEDEC JS-001-2017
Charged Device Model (CDM)	C3	250 to <500 V	JESD22-C101F



ESD HANDLING PRECAUTION: This device is designed to be Class 1A for HBM. Static charges may easily produce potentials higher than this with improper handling and can discharge into DUT and damage it. As a preventive measure industry standard ESD handling precautions should be used at all times to protect the device from ESD damage

MSL RATING

Moisture Sensitivity: MSL1 in accordance with IPC/JEDEC J-STD-020E /JEDEC J-STD-033C



FUNCTIONAL DIAGRAM

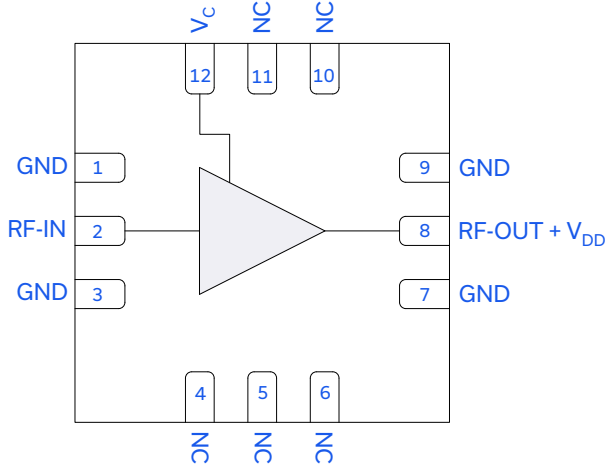

Figure 1. PVGA-123+ Functional Diagram

PAD DESCRIPTION

Function	Pad Number	Description (Refer to Figure 2)
RF-IN	2	RF-IN Pad connects to RF-Input port.
RF-OUT + V _{DD}	8	RF-OUT + DC Pad connects to RF-Output and DC port.
V _c	12	DC Input Pad connects to control voltage input port V _c .
GND	1, 3, 7, 9, & Paddle	Connects to ground.
NC	4, 5, 6, 10, 11	Not used internally. Connected to ground on test board.

EVALUATION BOARD

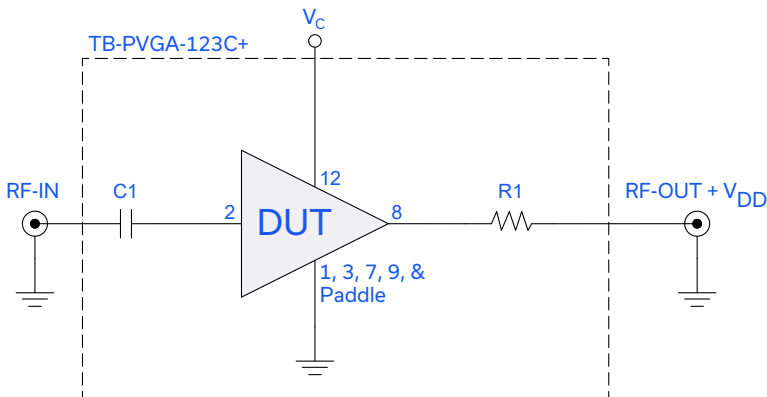

Figure 2. DUT soldered on Mini-Circuits Evaluation Board: TB-PVGA-123C+

Electrical Parameters and Conditions

Gain, Return Loss, Output Power at 1dB Compression (P_{1dB}), Output IP3 (OIP3) and Noise Figure measured using N5245A PNA-X microwave network analyzer.

Conditions:

- Gain and Return Loss: P_{IN} = -25 dBm
- Output IP3 (OIP3): Two tones, spaced 1 MHz apart, -5 dBm/tone at output.

Component	Vendor	Vendor P/N	Value	Size
C1	Murata	GRM1555C1H101JA01J	100pF	0402
R1	KOA Speer	RK73Z1ETTP	0Ω	0402



CASE STYLE DRAWING

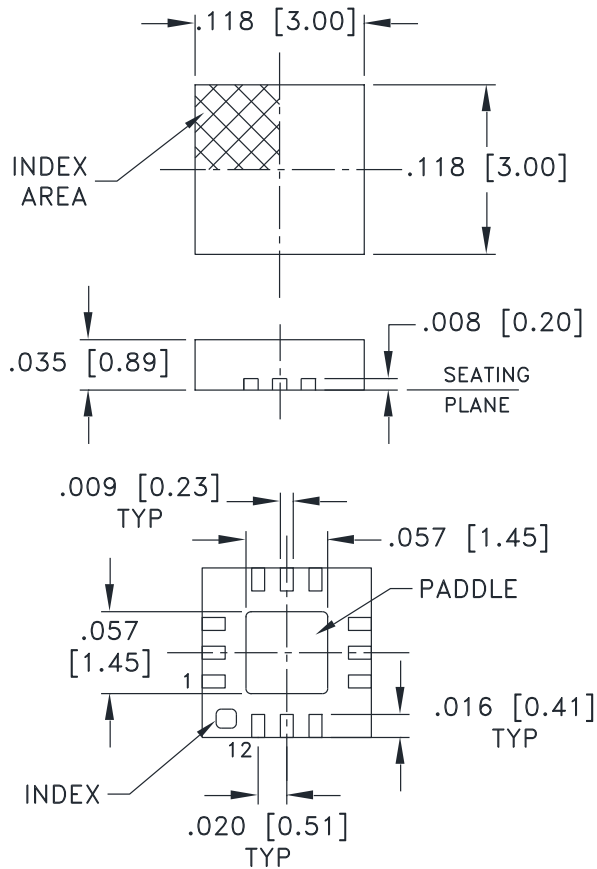

PCB Land Pattern

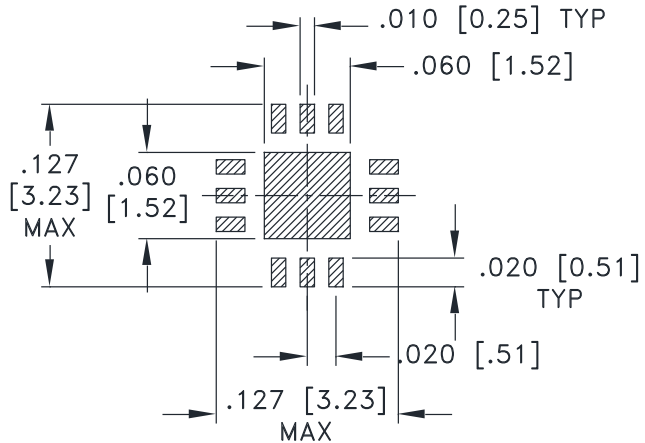

SUGGESTED LAYOUT,
TOLERANCE TO BE WITHIN ±.002

Weight: .02 Grams

Dimensions are in inches [mm]. Tolerances in inches: 2 Pl. ±.01; 3 Pl. ±.004 inches

PRODUCT MARKING

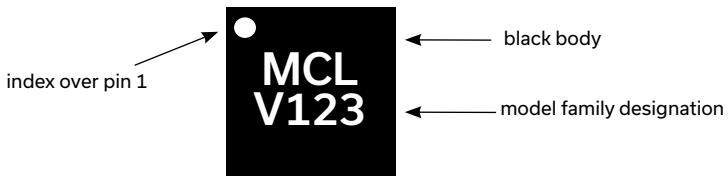

Marking may contain other features or characters for internal lot control



MMIC SURFACE MOUNT

Variable Gain Amplifier

PVGA-123+

50Ω 0.4 to 12 GHz

ADDITIONAL DETAILED INFORMATION IS AVAILABLE ON OUR DASHBOARD. [CLICK HERE](#)

Performance Data	Data Graphs S-Parameter (S2P Files) Data Set (.zip file)
Case Style	DQ1225 Plastic package, exposed paddle, lead finish: Matte-Tin
RoHs Status	Compliant
Tape & Reel	F66
Standard quantities available on reel	7" reels with 20, 50, 100, 200, 500,1K or 2K devices
Suggested Layout for PCB Design	PL-749
Evaluation Board	TB-PVGA-123C+ Gerber File
Environmental Ratings	ENV08T1

NOTES

- A. Performance and quality attributes and conditions not expressly stated in this specification document are intended to be excluded and do not form a part of this specification document.
- B. Electrical specifications and performance data contained in this specification document are based on Mini-Circuit's applicable established test performance criteria and measurement instructions.
- C. The parts covered by this specification document are subject to Mini-Circuits standard limited warranty and terms and conditions (collectively, "Standard Terms"); Purchasers of this part are entitled to the rights and benefits contained therein. For a full statement of the standard terms and the exclusive rights and remedies thereunder, please visit Mini-Circuits' website at www.minicircuits.com/terms/viewterm.html



Looking for pricing, stock, or lifecycle information?

Click below to explore more details on WIN SOURCE:

 [View PVGA-123+ on WIN SOURCE](#)

 [Mini-Circuits Information](#)

Optimize Your Supply Chain with WIN SOURCE Solutions

-  Global Sourcing Solution
-  Obsolete Management
-  Cost Control Management
-  Shortage Management
-  Alternative Solution
-  Excess Inventory Management