

1 Description

Ideally suited to the needs of Automated Test Equipment, Instrumentation and Telecommunications requirements, Coto's 9814/H & 9852 Series is a miniature Surface Mount Reed Relay that combines small size with exceptional RF performance. The 9814/H extends life at ATE loads 3X or more utilizing Coto's proprietary switch technology. The external Magnetic Shield reduces interaction between parts in high density boards. The 9852 adds Form C capability. Small size plus added features allow for high density packing, and make these relays ideal for designs such as high speed, high pin count VLSI testers where high speed, small size and high performance are all needed.

Device Packages

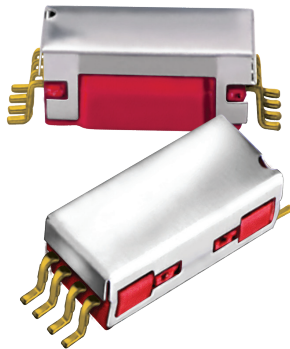

2 Features

- ▶ High Power - 10 Watt version available on model 9814H
- ▶ Available in Gull wing and "J" bend lead configurations
- ▶ Coaxial shield for 50 Ω
- ▶ 6.5 GHz bandwidth for RF and Pulse switching (fast rise time pulses)
- ▶ High insulation resistance - $10^{12} \Omega$ (Form A)
- ▶ Gold plated terminals
- ▶ External Magnetic Shield
- ▶ Tape and Reel packaging available
- ▶ High reliability, hermetically sealed contacts for long life
- ▶ High speed switching compared to electromechanical relays
- ▶ Molded thermoset body on integral lead frame design
- ▶ RoHS Compliant

3 Applications

- ▶ Automated Test Equipment (ATE)
- ▶ Instrumentation
- ▶ Telecommunications

4 Dimensions

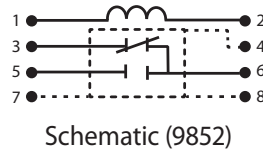
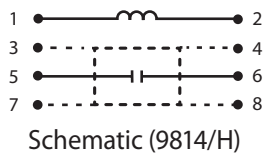
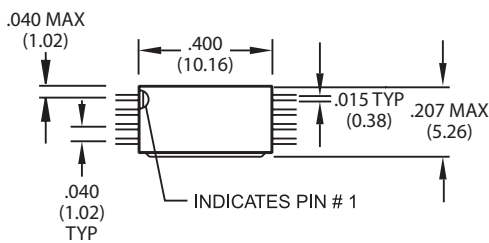

In Inches (Millimeters)

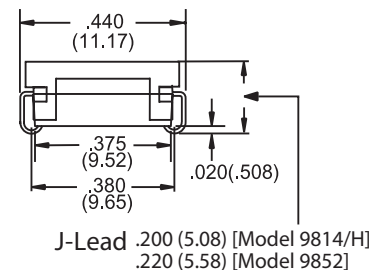
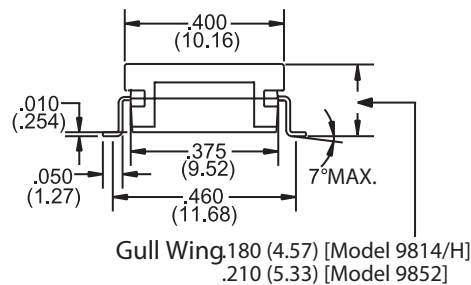

RECOMMENDED PAD LAYOUT		Leads	J Bend	Gull Wing
A			.490 (12.4)	.560 (14.2)
B			.240 (6.1)	.400 (10.2)
C			.125 (3.2)	.080 (2.0)
D			.030 (0.8)	
E			.040 (1.0)	
F			.150 (3.8)	

5 Ordering Information

Part Number	98XX-XX-XXH		Version
Model Number	9814	9852	H = High Power (Available only on Model 9814)
Coil Voltage	03 = 3.3 volts	05 = 5 volts	Lead Style
			00 = Gull Wing
			20 = J-Lead

6 Parameters - Model Number 9814/H & 9852 Series

Parameters	Test Conditions	Units	9814	9814H ²	9852
Relay Configuration			Traditional	High Power	1 Form C
			1 Form A, 50 Ω Coaxial	50 Ω Coaxial	50 Ω Coaxial
Coil Specs.					
Nom. Coil Voltage		VDC	3.3	5.0	3.3 5.0
Max. Coil Voltage		VDC	4.0	6.0	4.0 6.0
Coil Resistance	+/- 10%, 25°C	Ω	70	150	70 110
Operate Voltage	Must Operate By	VDC - Max.	2.5	3.8	2.50 3.8
Release Voltage	Must Release By	VDC - Min.	0.4	0.4	0.4 0.4
Contact Ratings					
Switching Voltage	Max DC/Peak AC Resist.	Volts	100	170	30
Switching Current	Max DC/Peak AC Resist.	Amps	0.25	0.25	0.1
Carry Current	Max DC/Peak AC Resist.	Amps	0.5	1.0	0.2
Contact Rating	Max DC/Peak AC Resist.	Watts	3	10	3
Life Expectancy - Typical ¹	Signal Level 1.0V, 10mA	x 10 ⁶ Ops.	1000	1000	100 N/C 200 N/O
Static Contact Resistance (Max. Init.)	50mV, 10mA	Ω	0.125	0.125	0.200
Dynamic Contact Resistance (Max. Init.)	0.5V, 50mA at 100Hz, 1.5msec.	Ω	0.150	0.150	0.200
Relay Specifications					
Insulation Resistance (Min.)	Between all Isolated Pins at 100V, 25°C, 40%RH	Ω		10 ¹²	10 ⁹
Capacitance - Typical Across Open Contacts	No Shield Shield Floating Shield Guarding	pF		- - 0.2	- - 1.0
Capacitance - Typical Open Contact to Coil	No Shield Shield Floating Shield Guarding	pF		- - 0.5	- - 1.0
Capacitance - Typical Closed Contact to Coil	Shield Guarding	pF		0.5	0.5
Capacitance - Typical Contact to Shield	Contacts Open, Shield Floating	pF		-	-
Dielectric Strength (Min.)	Between Contacts Contacts to Shield Contacts / Shield to Coil	VDC/peak AC		200 1500 1500	200 1000 1000
Operate Time - Including Bounce - Max.	At Nominal Coil Voltage, 30Hz, Square Wave	msec.		0.25	1.0
Release Time - Typical		msec.		0.05	1.0

General Notes:

1. Consult factory for life expectancy at other switching loads. Resistance > 2.0 ohms defines end of life.
2. Part number 9814-XX-XXH is the high power version of our traditional 9814 series.

Environmental Ratings:

Storage Temp:-35°C to + 100°C; Operating Temp: -20°C to +85°C
 Vibration: 20 G's to 2000 Hz; Shock: 50 G's

All electrical parameters measured at 25°C unless otherwise specified.

7 Package Information

Tape & Reel Dimensions

- 1000 relays per reel when ordered as 9814-XX-XXTR, 9814-XX-XXHTR or 9852-XX-XXTR

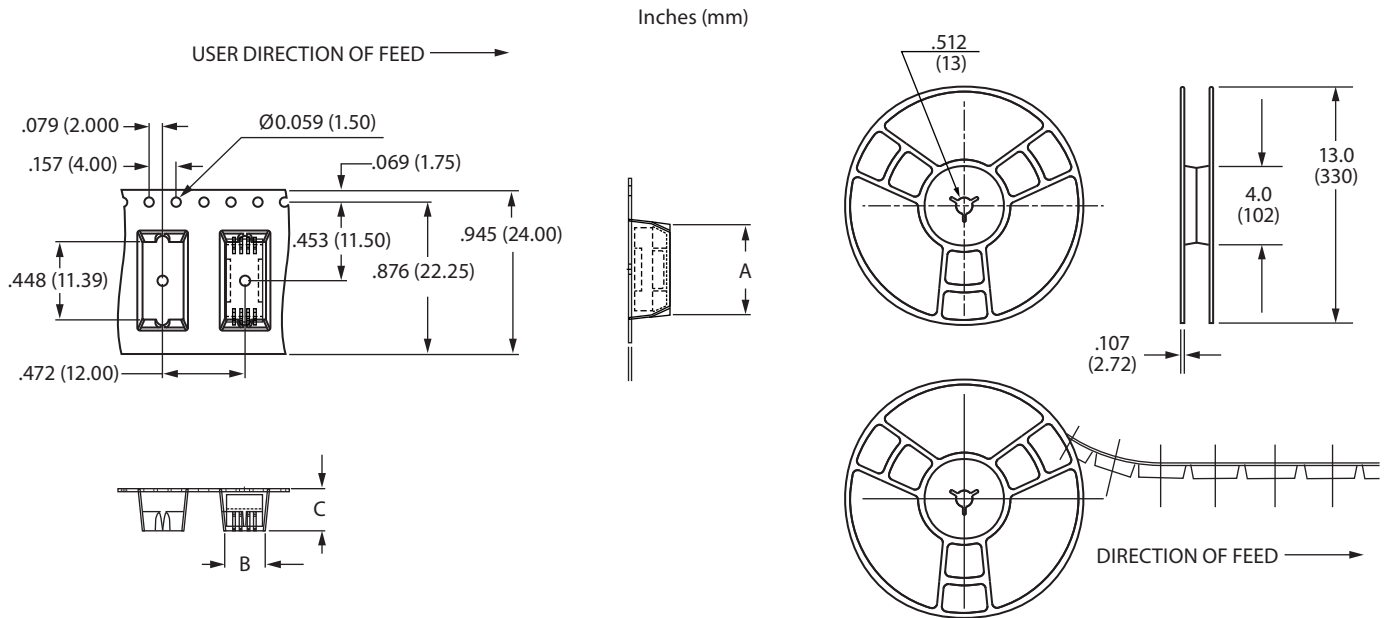

MODEL	9814/H		9852	
Leads	Gull Wing	J Bend	Gull Wing	J Bend
A	0.52 (13.2)	0.44 (11.2)	0.52 (13.2)	0.44 (11.2)
B	0.19 (4.83)	0.19 (4.83)	0.20 (5.08)	0.20 (5.08)
C	0.19 (4.83)	0.19 (4.83)	0.23 (5.84)	0.23 (5.84)

Plastic Tube Dimensions

- 98 relays per tube when ordered as 9814-XX-XX and 9814-XX-XXH
- 97 relays per tube when ordered as 9852-XX-XX

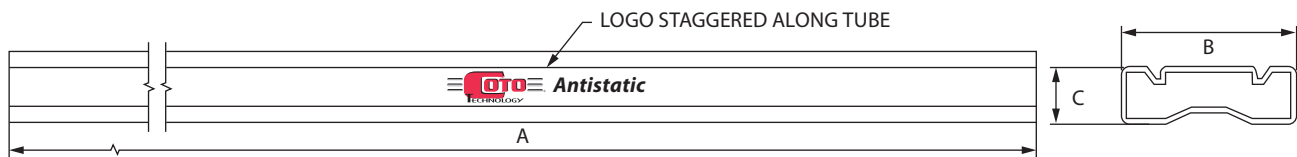

MODEL	9814/H	9852
A	20.2 (51.3)	20.2 (51.3)
B	1.022 (26)	1.022 (26)
C	0.306 (7.8)	0.322 (8.2)

8 Relay Processing Notes

8.1 Soldering

Coto Technology uses a higher temperature solder for all internal connections. We recommend that the max relay temperature during the solder reflow process does not exceed 260°C for 10 seconds maximum. Temperature and time more than the recommended levels may result in damage to the relay. Recommended solder profile as below.

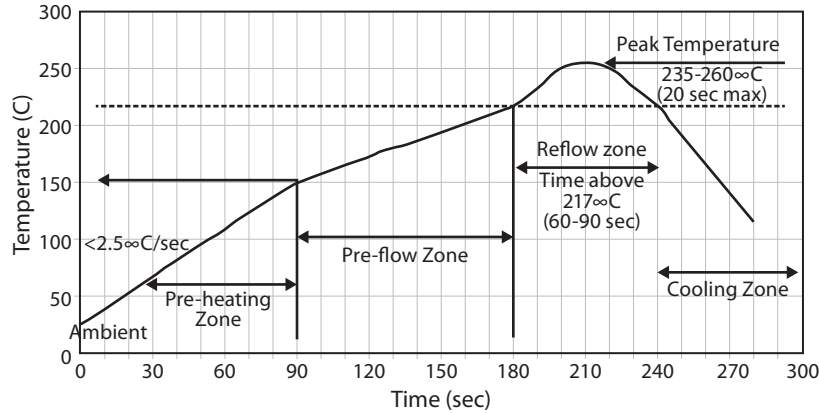

8.2 Cleaning

9814/H & 9852 are designed and manufactured to provide an adequate seal from external conditions. However, caution must be taken during the cleaning process not to expose the relays to conditions that will allow moisture to permeate into the package. Caution should be taken with dwell time between reflow and cleaning, high pressure spraying, and time in cleaning solvent/aqueous solutions, as these cleaning process parameters can contribute to moisture permeation. Board level bake out may be required after wash to remove moisture that has been introduced during cleaning operations.

8.3 Relay Storage

Relay parametric specifications are specified at 25°C and 40% RH. Reduced relay performance may result if storage or use environments significantly exceed these conditions. If high insulation resistance is required, Coto Technology recommends that relay storage, processing, and use environments are adequate to achieve the desired results. Relays should be stored in similar environmental conditions as other high-reliability active and passive electronic components. Proper storage of relays is also important to maintain solderability over an extended period of time.

8.4 Handling

Relays should be handled with care. Dropping or mishandling relays may result in damage that can contribute to a direct failure or, even worse, a latent field failure. If relays are dropped, Coto Technology recommends that they should be discarded.

Coto Technology does not recommend use of ultrasonic activated equipment with relays. The use of ultrasonic equipment may change the characteristics of the relay and can contribute to failure.

For more **technical and application information**, please refer to the following QR code:



For **Recommendations and Best Practices for Form C Relays** refer to the following QR code:



9 IMPORTANT NOTICE AND DISCLAIMER

COTO TECHNOLOGY, INC. ("COTO") PROVIDES THIS DATA SHEET "AS IS" AND WITH ALL FAULTS, AND DISCLAIMS ANY AND ALL WARRANTIES, EXPRESS AND IMPLIED, WITH RESPECT TO INFORMATION SET FORTH HEREIN, INCLUDING, WITHOUT LIMITATION, ANY IMPLIED WARRANTIES OF ACCURACY, COMPLETENESS, MERCHANTABILITY, FITNESS FOR A PARTICULAR PURPOSE AND NON-INFRINGEMENT OF THIRD-PARTY INTELLECTUAL PROPERTY RIGHTS. Your receipt of this data sheet constitutes your acknowledgement and acceptance of, and agreement to, all of the terms, conditions, notes, notices, disclaimers and limitations set forth herein.

This data sheet is subject to change without notice. Coto reserves the right to make, from time to time, changes to specifications set forth herein as may be necessary or desirable to improve the performance, reliability and/or manufacturability of the products described herein. As such, before placing an order of any Coto product described herein, you must verify that the information set forth herein is current with respect to such product, and Coto assumes no responsibility for any damages which you may incur due to your failure to do so.

Coto grants you permission to use this data sheet only for information and reference purposes, and any other use of this data sheet by you is prohibited. No license to any intellectual property right of Coto or any third party is granted hereunder.

You are solely responsible for (1) deciding whether to purchase or use any Coto product, (2) selecting appropriate Coto products for your application, (3) designing, validating and testing your application incorporating or involving any Coto product and (4) ensuring that such application meets applicable safety, security, regulatory or other requirements or standards. Any purchase or use of any Coto product must fully comply with all applicable laws and regulations, including, without limitations, import and export regulations.

Coto products described herein have been designed, developed and manufactured to be used in the standard commercial applications similar to those shown herein ("Specific Applications"). Any application requiring measures of reliability, robustness, safety or certifications not shown or beyond those shown herein is at the user's risk and is not warranted or guaranteed by Coto. Therefore, you are advised to use Coto products described herein only in Specific Applications.

Your purchase and use of Coto products, including, without limitation, those products described herein, are subject to Coto's terms and conditions of sale and other applicable terms available on Coto's website or otherwise provided or made available in conjunction with such products. Unless such terms and conditions state otherwise, COTO PRODUCTS ARE PROVIDED "AS IS" AND WITH ALL FAULTS, AND ANY AND ALL WARRANTIES, EXPRESS AND IMPLIED, WITH RESPECT TO SUCH PRODUCTS, INCLUDING, WITHOUT LIMITATION, ANY IMPLIED WARRANTIES OF MERCHANTABILITY, FITNESS FOR A PARTICULAR PURPOSE AND NON-INFRINGEMENT OF THIRD-PARTY INTELLECTUAL PROPERTY RIGHTS, ARE DISCLAIMED. Coto's provision of this data sheet does not expand or otherwise alter Coto's applicable warranties or warranty disclaimers for Coto products.

Coto disclaims responsibility for, and you will fully defend, indemnify and hold harmless Coto, its affiliates and its and their respective equity holders, directors, officers, employees, representatives, agents, successors and assigns against and for, any and all claims, damages, costs, losses and liabilities arising out of your use of this data sheet or your purchase or use of any Coto product described herein.

Looking for pricing, stock, or lifecycle information?

Click below to explore more details on WIN SOURCE:

 [View 9814-05-00](#) on WIN SOURCE

 [Coto Technology](#) Information

Optimize Your Supply Chain with WIN SOURCE Solutions

-  Global Sourcing Solution
-  Obsolete Management
-  Cost Control Management
-  Shortage Management
-  Alternative Solution
-  Excess Inventory Management