

# EMMY-W1 series

## Host-based multiradio modules with Wi-Fi and Bluetooth

### Data sheet

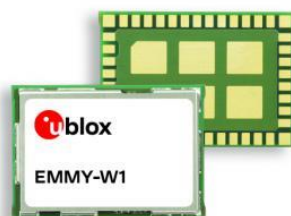

### Abstract

This technical data sheet describes the EMMY-W1 series modules with Wi-Fi 802.11ac and Bluetooth® v4.2 designed for both simultaneous and independent operation. These modules include an integrated MAC/baseband processor and RF front-end components and can connect to a host processor through SDIO 3.0 or high-speed UART interfaces. A PCM interface is available for Bluetooth audio applications. These modules are offered in both professional and automotive grades.

# Document information

<b>Title</b>	<b>EMMY-W1 series</b>	
<b>Subtitle</b>	Host-based multiradio modules with Wi-Fi and Bluetooth	
<b>Document type</b>	Data sheet	
<b>Document number</b>	UBX-15011785	
<b>Revision and date</b>	R11	27-Aug-2019
<b>Disclosure restriction</b>		

<b>Product status</b>	<b>Corresponding content status</b>	
Functional sample	Draft	For functional testing. Revised and supplementary data will be published later.
In development / Prototype	Objective specification	Target values. Revised and supplementary data will be published later.
Engineering sample	Advance information	Data based on early testing. Revised and supplementary data will be published later.
Initial production	Early production information	Data from product verification. Revised and supplementary data may be published later.
Mass production / End of life	Production information	Final product specification.

This document applies to the following products:

<b>Product name</b>	<b>Type number</b>	<b>Firmware versions</b>	<b>PCN reference</b>	<b>Product status</b>
EMMY-W161	EMMY-W161-00B-00	Wi-Fi: 15.44.7; 15.68.7;	UBX-17005747 UBX-19030134	Mass production
EMMY-W161-A	EMMY-W161-00A-00	BT: 15.26.7;15.28.7;15.29.7; 15.100.7	UBX-17005747 UBX-19030134	Mass production
EMMY-W163	EMMY-W163-00B-00		UBX-16017374 UBX-17005747	Mass production
EMMY-W163-A	EMMY-W163-00A-00		UBX-16017374 UBX-17005747	Mass production
EMMY-W165	EMMY-W165-00B-00		UBX-17005747	Mass production
EMMY-W165-A	EMMY-W165-00A-00		UBX-17005747	Mass production

u-blox or third parties may hold intellectual property rights in the products, names, logos and designs included in this document. Copying, reproduction, modification or disclosure to third parties of this document or any part thereof is only permitted with the express written permission of u-blox.

The information contained herein is provided "as is" and u-blox assumes no liability for its use. No warranty, either express or implied, is given, including but not limited to, with respect to the accuracy, correctness, reliability and fitness for a particular purpose of the information. This document may be revised by u-blox at any time without notice. For the most recent documents, visit [www.u-blox.com](http://www.u-blox.com).

Copyright © u-blox AG.

# Contents

<b>Document information</b> .....	<b>2</b>
<b>Contents</b> .....	<b>3</b>
<b>1 Functional description</b> .....	<b>5</b>
1.1 Overview .....	5
1.2 Applications .....	5
1.3 Product features .....	6
1.4 Block diagrams .....	7
1.5 Product description .....	8
1.6 Supported features .....	8
1.6.1 Wi-Fi features .....	8
1.6.2 Bluetooth features .....	8
1.6.3 General product features .....	8
1.6.4 Compliance .....	9
1.7 Additional reserved MAC addresses .....	9
<b>2 Interfaces</b> .....	<b>10</b>
2.1 Operation mode configuration .....	10
2.2 SDIO interface .....	10
2.2.1 Default speed and High speed modes .....	10
2.2.2 SDR12, SDR25, SDR50 Modes (up to 100 MHz) (1.8 V) .....	11
2.2.3 SDR104 Mode (150 MHz) (1.8 V) .....	12
2.2.4 DDR50 Mode (50 MHz) (1.8 V) .....	13
2.3 High Speed UART interface .....	14
2.4 PCM interface .....	15
2.4.1 PCM interface specifications .....	15
2.5 GPIO interface .....	16
2.6 JTAG interface .....	17
<b>3 Pin definition</b> .....	<b>18</b>
3.1 Pin description .....	18
3.2 Reset configuration .....	20
3.3 Configuration pins .....	20
<b>4 Electrical specification</b> .....	<b>21</b>
4.1 Absolute maximum ratings .....	21
4.2 Operating conditions .....	21
4.3 Digital pin ratings .....	22
4.4 Wi-Fi power consumption .....	22
4.5 Bluetooth power consumption .....	23
4.6 Radio specifications .....	24
4.6.1 Wi-Fi .....	24
4.6.2 Bluetooth .....	26
4.6.3 LTE co-existence .....	26
<b>5 Host drivers and firmware</b> .....	<b>27</b>
5.1 General principle .....	27

5.2 Supported operating systems .....	27
5.2.1 Linux .....	27
5.2.2 QNX.....	27
<b>6 Mechanical specifications .....</b>	<b>28</b>
<b>7 Qualification and approvals.....</b>	<b>30</b>
7.1 Country Approvals .....	30
7.1.1 European Union regulatory compliance .....	30
7.1.2 FCC compliance .....	31
7.1.3 IC compliance.....	32
7.1.4 Australia and New Zealand regulatory compliance .....	33
7.1.5 Korean KCC compliance .....	34
7.1.6 Japan radio equipment compliance.....	34
7.1.7 Taiwan NCC compliance.....	35
7.1.8 China SRRC Radio Transmission Equipment compliance .....	35
7.2 Approved antennas .....	36
7.2.1 Wi-Fi / Bluetooth Dual Band Antennas.....	36
7.2.2 Bluetooth antenna.....	37
7.3 Bluetooth qualification.....	37
7.3.1 Bluetooth host stack.....	37
<b>8 Product handling.....</b>	<b>38</b>
8.1 Packaging .....	38
8.1.1 Reels .....	38
8.1.2 Tapes.....	38
8.2 Shipment, storage and handling .....	39
8.2.1 Moisture sensitivity levels .....	39
8.2.2 Mounting process and soldering recommendations .....	39
8.2.3 ESD handling precautions .....	40
<b>9 Labeling and ordering information .....</b>	<b>42</b>
9.1 Product labeling.....	42
9.1.1 EMMY-W161 .....	42
9.1.2 EMMY-W163.....	43
9.1.3 EMMY-W165.....	44
9.2 Explanation of codes .....	44
9.3 Ordering codes.....	45
<b>Appendix .....</b>	<b>46</b>
<b>Related documents .....</b>	<b>48</b>
<b>Revision history .....</b>	<b>49</b>
<b>Contact.....</b>	<b>51</b>

# 1 Functional description

## 1.1 Overview

The EMMY-W1 series provides a complete short range transceiver solution that can easily be integrated into automotive and industrial applications. The modules are designed for both simultaneous and independent operation of the following technologies:

- IEEE 802.11a/b/g/n/ac data rates for Wi-Fi
- Dual-mode Bluetooth v4.2

The EMMY-W1 series is a surface-mount device (SMD) component and can be used as a Wi-Fi micro-access point supporting up to 10 clients. A coexistence feature at the chip level improves parallel use of Bluetooth and Wi-Fi communication. For highest throughput and performance, a module variant with separate Wi-Fi and Bluetooth antenna pins is also available.

The modules include an integrated MAC/baseband processor and RF front-end components and can connect to a host processor through SDIO 3.0 and high-speed UART interfaces. The EMMY-W1 series are offered in automotive and professional grades (see Ordering codes and Block diagrams). The automotive grade variant includes an automotive-qualified (AEC-Q100) chipset. A host driver for Linux 3.x is available free of charge. The modules are radio type approved<sup>1</sup> for Europe (ETSI RED), US (FCC CFR 47 part 15 unlicensed modular transmitter approval), Canada (IC RSS), Korea (KCC), Japan (MIC), Taiwan (NCC), Australia / New Zealand (ACMA) and China (SRRC). Approvals for other countries may be possible upon inquiry.

## 1.2 Applications

### Automotive applications

- High definition (HD) video streaming (headrest displays, rear-view camera) and in-car gaming
- Rapid sync-n-go applications and fast content download to the vehicle
- Hands-free equipment (Bluetooth)

### Industrial applications

- Manufacturing floor automation, wireless control terminals and point-to-point backhaul
- Outdoor content distribution
- Mobile video streaming
- Robust wireless connectivity in a broad range of industrial applications

---

<sup>1</sup> See section 7.1 for an overview of the specific module variants that are approved for each country

### 1.3 Product features

	EMMY-W161	EMMY-W163	EMMY-W165
<b>Grade</b>			
Automotive	•	•	•
Professional	•	•	•
Standard			
<b>Radio</b>			
Bluetooth qualification	v4.2		
Bluetooth profiles	HCI		
Bluetooth BR/EDR	•	•	•
Bluetooth low energy	•	•	•
Wi-Fi IEEE 802.11 standards	a/b/g/n/ac		
Wi-Fi 2.4 / 5 [GHz]	2.4 and 5		
LTE filter	•		
Bluetooth output power conducted [dBm]	10	10	10
Wi-Fi output power conducted [dBm]	18	18	18
Antenna type	1p	2p	1p
<b>OS support</b>			
Android / Linux drivers (from u-blox)	•	•	•
QNX (via third party)	•	•	•
<b>Interfaces</b>			
High-speed UART <sup>B</sup>	1	1	1
SDIO [version]	v3	v3	v3
PCM (Bluetooth audio)	1	1	1
<b>Features</b>			
Micro Access Point [max connects]	10	10	10
AES hardware support	•	•	•
Wi-Fi direct	•	•	•
Factory-assigned MAC address	•	•	•
Factory calibrated RF	•	•	•
Simultaneous STA/AP on different channels	•	•	•

1p = 1 antenna pin for combined Bluetooth and Wi-Fi  
 B = For Bluetooth only    2p = 2 antenna pins, one each for Bluetooth and Wi-Fi

**Table 1: EMMY-W1 series main features summary**

## 1.4 Block diagrams

The block diagrams of the EMMY-W1 series are provided in this section.

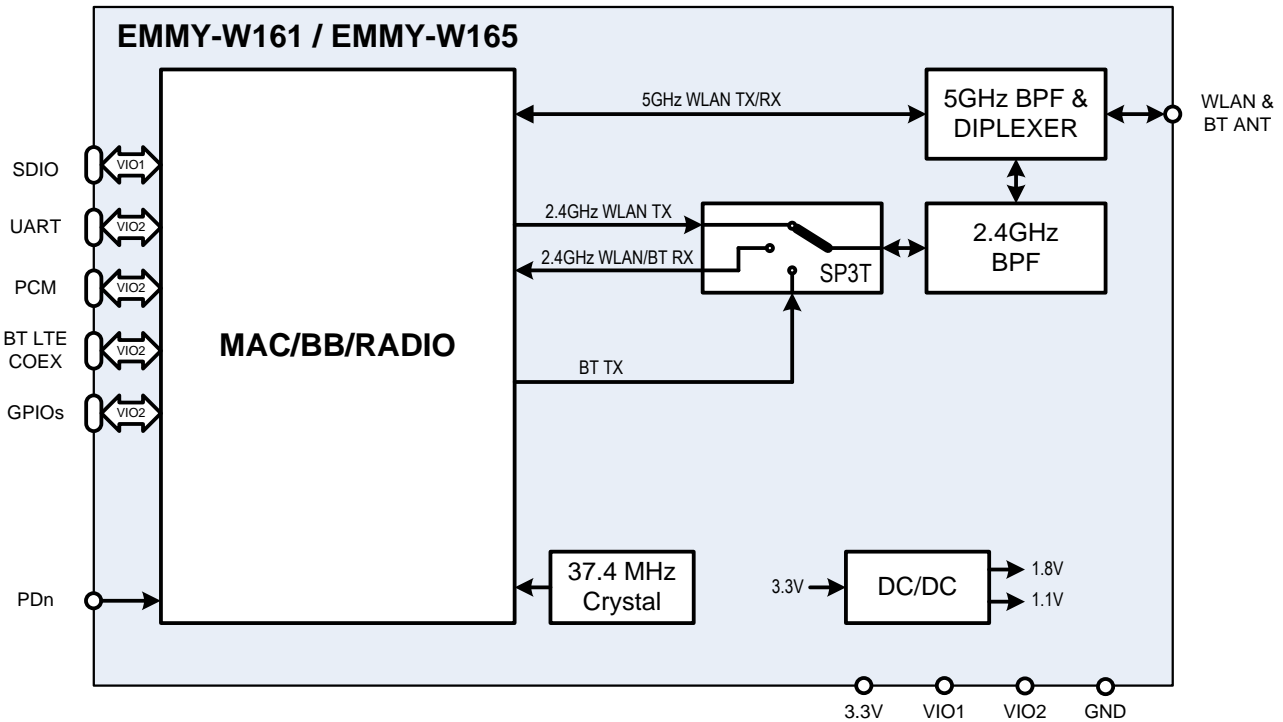

Figure 1: EMMY-W161/EMMY-W165 block diagram - Single antenna variant

**⚠** In EMMY-W161, the band pass filter (2.4 GHz BPF) is a BAW filter that enables co-existence with LTE. For the EMMY-W165 variant, the band pass filter provides no co-existence protection against a co-located LTE transmitter.

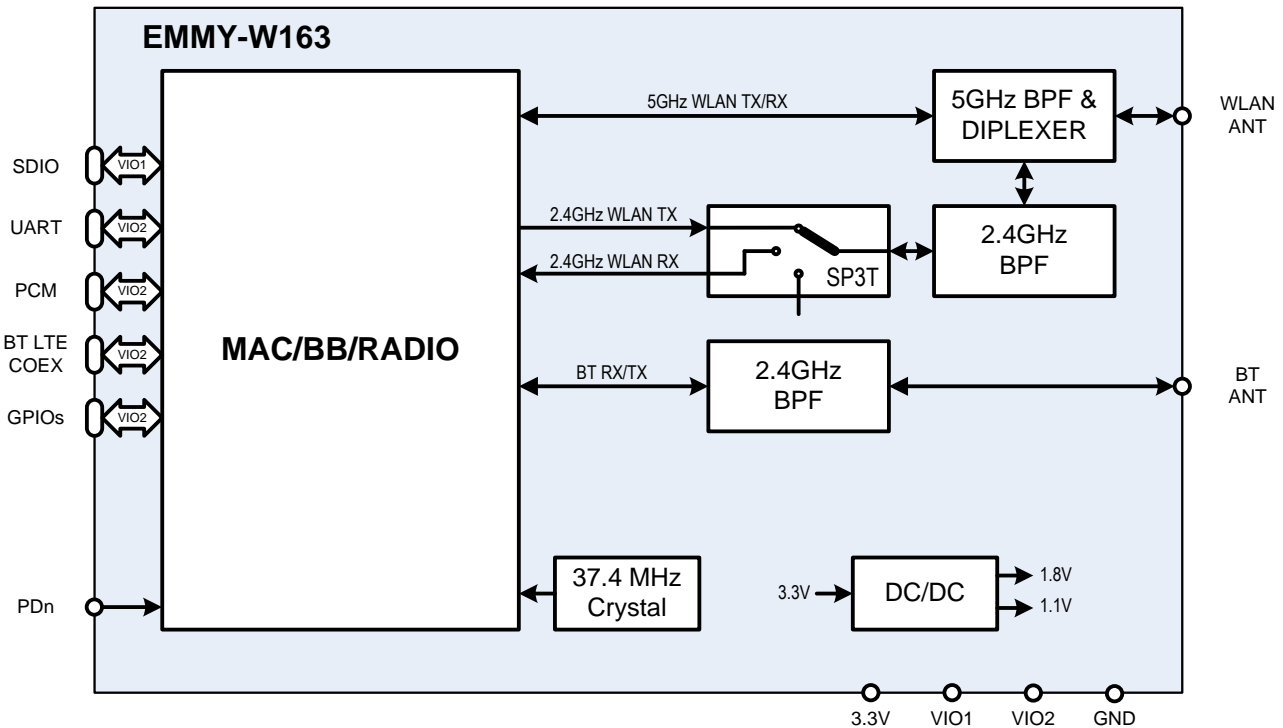



Figure 2: EMMY-W163 block diagram - Dual-antenna variant

 In EMMY-W163, the bandpass filters (2.4 GHz BPF) are ceramic bandpass filters. An LTE co-existence variant is not available in the dual-antenna configuration.

## 1.5 Product description

Model	Description
EMMY-W161	Professional grade module with 1 combined antenna pin for Wi-Fi and Bluetooth and integrated LTE filter
EMMY-W163	Professional grade module with 2 separate antenna pins for Wi-Fi and Bluetooth (no LTE filter)
EMMY-W165	Professional grade module with 1 combined antenna pin for Wi-Fi and Bluetooth (no LTE filter)
EMMY-W161-A	Automotive grade module with 1 combined antenna pin for Wi-Fi and Bluetooth and integrated LTE filter
EMMY-W163-A	Automotive grade module with 2 separate antenna pins for Wi-Fi and Bluetooth (no LTE filter)
EMMY-W165-A	Automotive grade module with 1 combined antenna pin for Wi-Fi and Bluetooth (no LTE filter)

 The EMMY-W161 is recommended for applications that have co-located Wi-Fi, Bluetooth and LTE antennas and require co-existence of these wireless technologies. This module provides a dedicated BAW bandpass filter instead of the ceramic bandpass filter. This filter rejects the adjacent LTE bands B40, B7, B41, and B38. The integrated BAW filter is available only for the single-antenna configuration (EMMY-W161). The module pinout, operating conditions, and electrical characteristics are identical for all product variants. Differences in the RF parameters are explained in the Radio specifications section.

## 1.6 Supported features

### 1.6.1 Wi-Fi features

- Wi-Fi standards: IEEE 802.11a/b/g/n/ac/d/e/h/i/k<sup>2</sup>/r/v<sup>2</sup>/w
- Simultaneous client and access point operation (up to 10 clients supported)
- Support of Wi-Fi direct mode
- IEEE 802.11ac 1x1 antenna configuration
- IEEE 802.11 PHY data rates up to 433 Mbit/s
- 64- and 128-bit AES hardware encryption engine
- WAPI encryption is supported by hardware
- SDIO 3.0 host interface for Wi-Fi

### 1.6.2 Bluetooth features

- Bluetooth v4.2 with Bluetooth Low Energy and Classic Bluetooth v2.1+EDR over SDIO or high-speed UART interface
- PCM interface for audio
- MWS/LTE coexistence serial transport interface for connecting an external and co-located LTE device<sup>3</sup>

### 1.6.3 General product features

- Driver support for Linux and QNX
- Low-power and sleep modes for Bluetooth and Wi-Fi core
- Coexistence arbitration for Wi-Fi/Bluetooth/LE/LTE operation
- Small footprint (19.8 mm x 13.8 mm), LGA package
- Product variant with integrated LTE co-location filter available
- Automotive qualification tests (climatic, mechanical, and operating life tests) according to ISO 16750-4

<sup>2</sup> Supported by hardware but not supported by firmware currently.

<sup>3</sup> Available on request

## 1.6.4 Compliance

- RoHS compliant
- Radio type approvals<sup>4</sup> for Europe, USA, Canada, Korea, Japan, Taiwan, China, Australia, and New Zealand

## 1.7 Additional reserved MAC addresses

The EMMY-W1 module series has four unique consecutive MAC addresses reserved for each module, from which the first two addresses are already stored in the configuration during production. The first address is used for the Bluetooth communication while the second address is configured for Wi-Fi communication. The Data Matrix Code on the label includes the Bluetooth MAC address (see section 9). The remaining two MAC addresses are not used in the manufacturing configuration, but are reserved for usage with the module.

MAC address	Assignment	Last two bits of MAC address	Example
Module1, address 1	Bluetooth	0b00	<i>D4:CA:6E:44:00:04</i>
Module1, address 2	Wi-Fi	0b01	D4:CA:6E:44:00:05
Module1, address 3	(free for use)	0b10	D4:CA:6E:44:00:06
Module1, address 4	(free for use)	0b11	D4:CA:6E:44:00:07
Module2, address 1	Bluetooth	0b00	<i>D4:CA:6E:44:00:08</i>
Module2, address 2	Wi-Fi	0b01	D4:CA:6E:44:00:09
Module2, address 3	(free for use)	0b10	D4:CA:6E:44:00:0A
Module2, address 4	(free for use)	0b11	D4:CA:6E:44:00:0B

**Table 2: MAC address assignment**

<sup>4</sup> See section 7.1 for an overview of the specific module variants that are approved for each country

## 2 Interfaces

### 2.1 Operation mode configuration

EMMY-W1 series module uses the GPIO\_3 and GPIO\_2 pins as host interface configuration input to set the desired operation mode following a reset. The definitions of these pins are changed to their usual functions after reset. When you need to configure the pins for a certain module operation mode, you need to provide a 100 kΩ pull down resistor to the ground. No external circuitry is required to set a configuration pin to high logical level.

External reset is not needed for proper operation due to internal power-up reset logic though it can be used by the host controller through the PDn pin (active low) in case of an abnormal module behavior.

After the firmware download, GPIO\_3 and GPIO\_2 pins can be used for secondary functionality such as PCM\_MCLK for GPIO\_3 or GPIO itself. But this depends on the firmware or driver version.

Depending on the firmware or driver used, you can use either one or both host interface operation modes:

GPIO_3	GPIO_2	Wi-Fi	Bluetooth	Number of SDIO functions
0	0	SDIO	UART	1 (Wi-Fi)
0	1	SDIO	SDIO	3 (Wi-Fi, Bluetooth)
1	0	SDIO	UART	1 (Wi-Fi)
1	1	SDIO	SDIO	3 (Wi-Fi, Bluetooth) <sup>5</sup>

Table 3: Module configuration

### 2.2 SDIO interface

EMMY-W1 series modules support an SDIO device interface that conforms to the industry standard SDIO 3.0 Full-Speed specification (4-bit SDIO up to 150 MHz) and allows a host controller using the SDIO bus protocol to access the Wi-Fi and Bluetooth functions. The interface supports 4-bit SDIO transfer mode at the full clock range of 0 to 150 MHz.

#### 2.2.1 Default speed and High speed modes

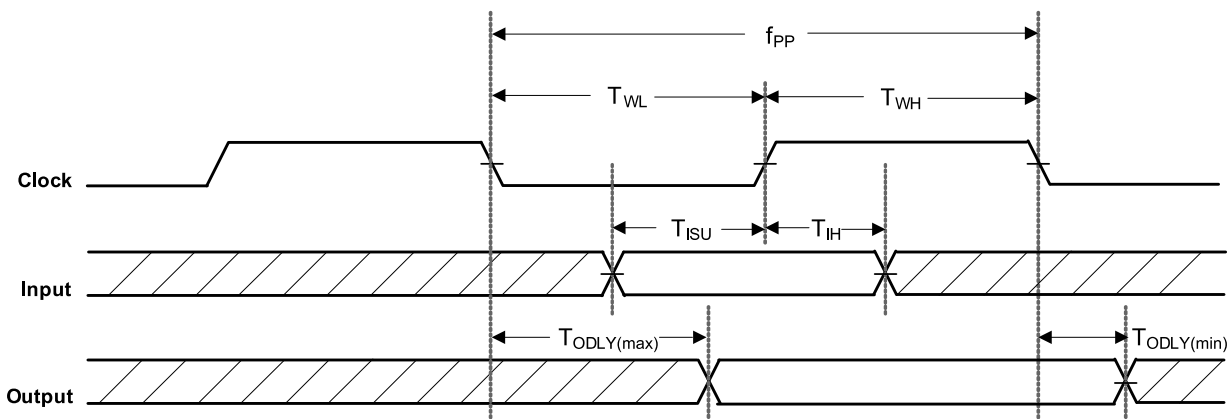
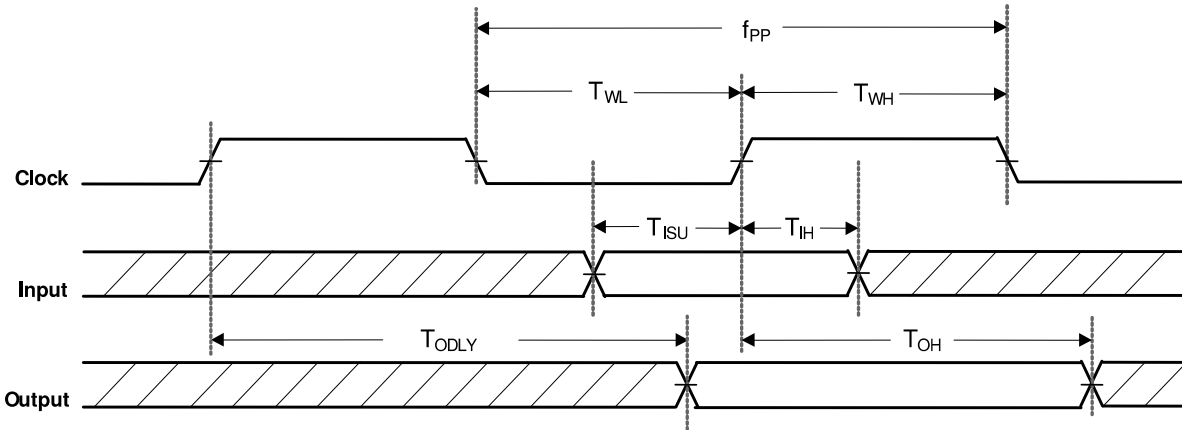

Figure 3: SDIO protocol timing diagram- Default speed mode (3.3 V)

<sup>5</sup> Default configuration.

**Figure 4: SDIO protocol timing diagram – High speed mode (3.3 V)**

Symbol	Parameter	Condition	Min.	Typ	Max.	Units
$f_{PP}$	Clock frequency	Normal	0	-	25	MHz
		High speed	0	-	50	MHz
$T_{WL}$	Clock low time	Normal	10	-	-	ns
		High speed	7	-	-	ns
$T_{WH}$	Clock high time	Normal	10	-	-	ns
		High speed	7	-	-	ns
$T_{ISU}$	Input setup time	Normal	5	-	-	ns
		High speed	6	-	-	ns
$T_{IH}$	Input hold time	Normal	5	-	-	ns
		High speed	2	-	-	ns
$T_{ODLY(max)}$	Maximal Output delay time	Normal	-	-	14	ns
$T_{ODLY(min)}$	Minimal Output delay time	Normal	-	-	0	ns
$T_{ODLY}$	Output delay time $CL \leq 40$ pF (1 card)	Normal	-	-	14	ns
$T_{OH}$	Output hold time	High speed	2.5	-	-	ns

**Table 4: SDIO timing data – Default speed, High speed modes (3.3 V)**

## 2.2.2 SDR12, SDR25, SDR50 Modes (up to 100 MHz) (1.8 V)

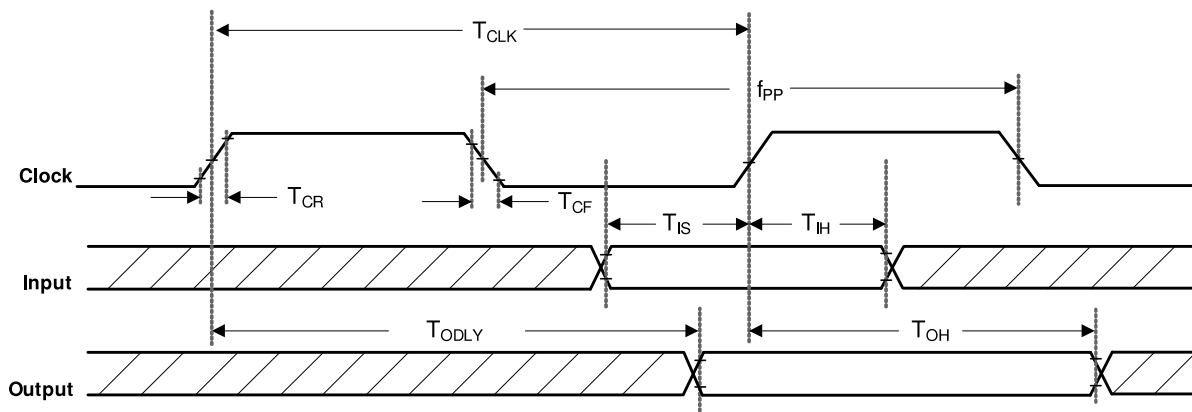
**Figure 5: SDIO protocol timing diagram – SDR12, SDR25, SDR50 modes (up to 100 MHz) (1.8 V)**

Symbol	Parameter	Condition	Min.	Typ	Max.	Units
$f_{PP}$	Clock frequency	SDR12/25/50	25	-	100	MHz
$T_{IS}$	Input setup time	SDR12/25/50	3	-	-	ns
$T_{IH}$	Input hold time	SDR12/25/50	0.8	-	-	ns
$T_{CLK}$	Clock time	SDR12/25/50	10	-	40	ns
$T_{CR}, T_{CF}$	Rise time, fall time $T_{CR}, T_{CF} < 2$ ns (max) at 100 MHz $C_{CARD} = 10$ pF	SDR12/25/50	-	-	$0.2 \cdot T_{CLK}$	ns
$T_{ODLY}$	Output delay time $C_L \leq 30$ pF	SDR12/25/50	-	-	7.5	ns
$T_{OH}$	Output hold time $C_L = 15$ pF	SDR12/25/50	1.5	-	-	ns

**Table 5: SDIO timing data – SDR12, SDR25, SDR50 modes (up to 100 MHz) (1.8 V)**

### 2.2.3 SDR104 Mode (150 MHz) (1.8 V)

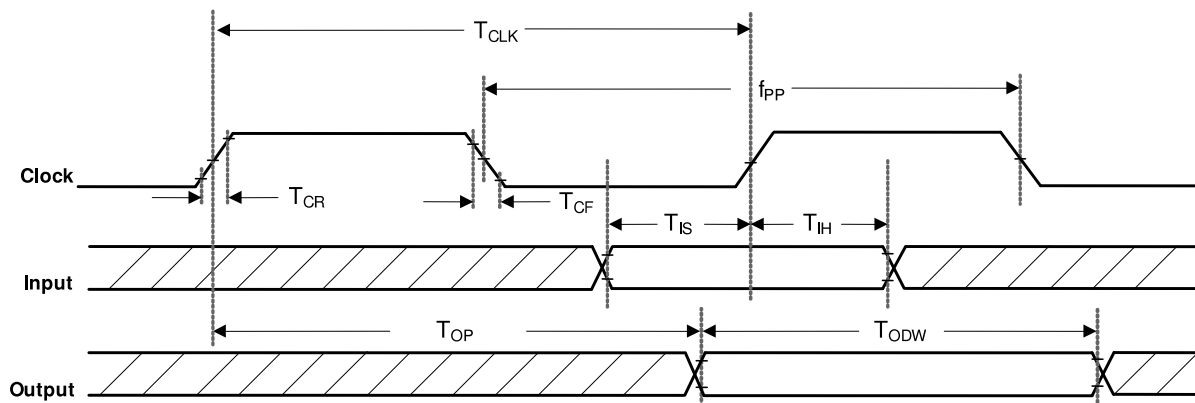
**Figure 6: SDIO protocol timing diagram – SDR104 mode (150 MHz)**

Symbol	Parameter	Condition	Min.	Typ	Max.	Units
$f_{PP}$	Clock frequency	SDR104	0	-	150	MHz
$T_{IS}$	Input setup time	SDR104	1.4	-	-	ns
$T_{IH}$	Input hold time	SDR104	0.8	-	-	ns
$T_{CLK}$	Clock time	SDR104	6.67	-	-	ns
$T_{CR}, T_{CF}$	Rise time, fall time $T_{CR}, T_{CF} < 0.96$ ns (max) at 150 MHz $C_{CARD} = 10$ pF	SDR104	-	-	$0.2 \cdot T_{CLK}$	ns
$T_{OP}$	Card output phase	SDR104	0	-	10	ns
$T_{ODW}$	Output timing of variable data window	SDR104	2.88	-	-	ns

**Table 6: SDIO timing data – SDR104 mode (150 MHz)**

### 2.2.4 DDR50 Mode (50 MHz) (1.8 V)

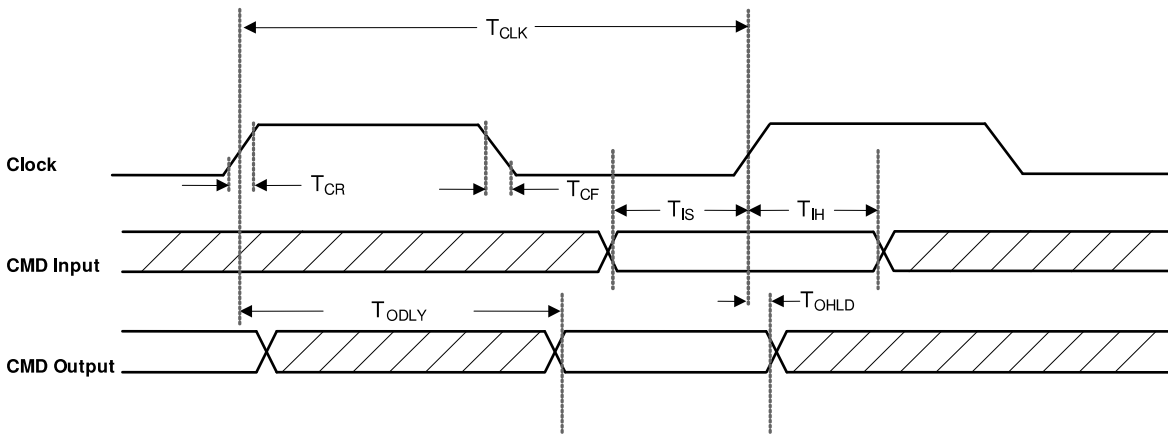
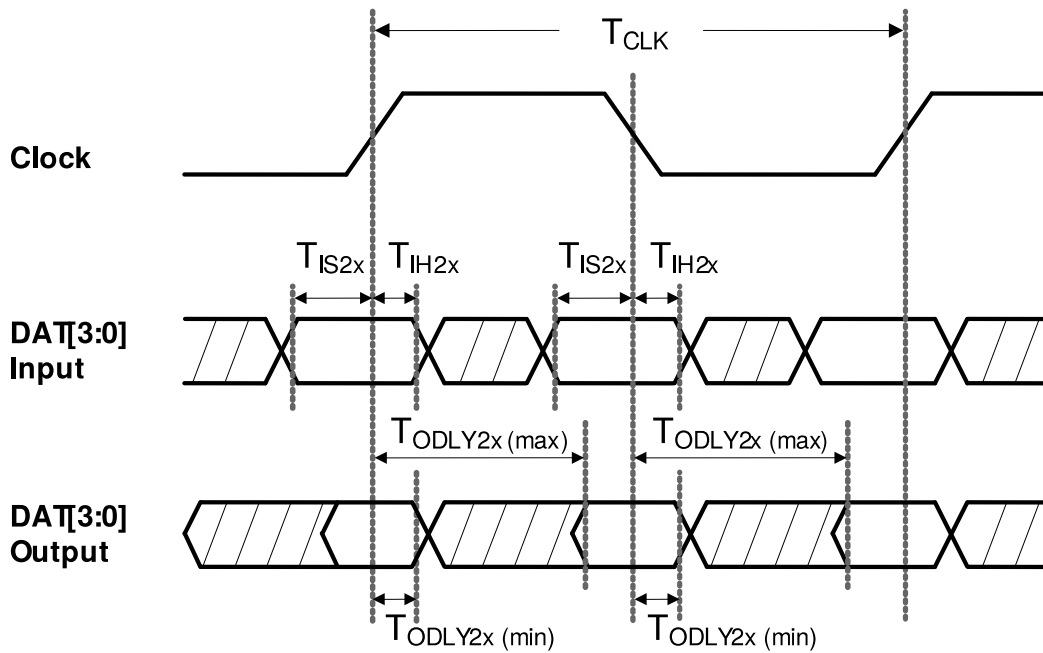

Figure 7: SDIO CMD timing diagram - DDR50 mode (50 MHz)



1. In DDR50 mode, DAT[3:0] lines are sampled on both edges of the clock (not applicable for CMD line).

Figure 8: SDIO DAT[3:0] timing diagram - DDR50 mode (50 MHz)

Symbol	Parameter	Condition	Min.	Typ	Max.	Units
<b>Clock</b>						
$T_{CLK}$	Clock time 50 MHz (max) between rising edges	DDR50	20			ns
$T_{CR}, T_{CF}$	Rise time, fall time $T_{CR}, T_{CF} < 4.00$ ns (max) at 50 MHz $C_{CARD} = 10$ pF	DDR50			$0.2 * T_{CLK}$	ns
<b>Clock Duty</b>		DDR50	45		55	%
CMD Input (referenced to clock rising edge)						
$T_{IS}$	Input setup time $C_{CARD} \leq 10$ pF (1 card)	DDR50	6			ns
$T_{IH}$	Input hold time $C_{CARD} \leq 10$ pF (1 card)	DDR50	0.8			ns
<b>CMD Output (referenced to clock rising edge)</b>						
$T_{ODLY}$	Output delay time during data transfer mode $C_L \leq 30$ pF (1 card)	DDR50			13.7	ns
$T_{OHLd}$	Output hold time $C_L \geq 15$ pF (1 card)	DDR50	1.5			ns
<b>DAT[3:0] Input (referenced to clock rising and falling edges)</b>						
$T_{IS2x}$	Input setup time $C_{CARD} \leq 10$ pF (1 card)	DDR50	3			ns
$T_{IH2x}$	Input hold time $C_{CARD} \leq 10$ pF (1 card)	DDR50	0.8			ns
<b>DAT[3:0] Output (referenced to clock rising and falling edges)</b>						
$T_{ODLY2x(max)}$	Output delay time during data transfer mode $C_L \leq 25$ pF (1 card)	DDR50			7.0	ns
$T_{ODLY2x(min)}$	Output hold time $C_L \geq 15$ pF (1 card)	DDR50	1.5			ns

Table 7: SDIO timing data – DDR50 mode (50 MHz)

## 2.3 High Speed UART interface

The EMMY-W1 series modules support a high speed Universal Asynchronous Receiver/Transmitter (UART) interface in compliance with the industry standard 16550 specification. The main features of the UART interface are:

- FIFO mode permanently selected for transmit and receive operations
- 2 pins for transmit and receive operations
- 2 flow control pins
- Interrupt triggers for low-power, high throughput operation
- High throughput (4 Mbps)

The UART interface operation includes:

- Uploading the firmware to the module
- Supporting data input/output operation for peripheral devices connected through a standard UART interface

Baud Rate				
1200	38400	460800	1500000	3000000
2400	57600	500000	1843200	3250000
4800	76800	921600	2000000	3692300
9600	115200	1000000	2100000	4000000
19200	230400	1382400	2764800	

**Table 8: Supported UART Baud rates**

## 2.4 PCM interface

The EMMY-W1 series modules support a Pulse Code Modulation (PCM) interface that provides:

- Master or slave mode
- PCM bit width size of 8 bits or 16 bits
- Up to 4 slots with configurable bit width and start positions
- Short frame and long frame synchronization

### 2.4.1 PCM interface specifications

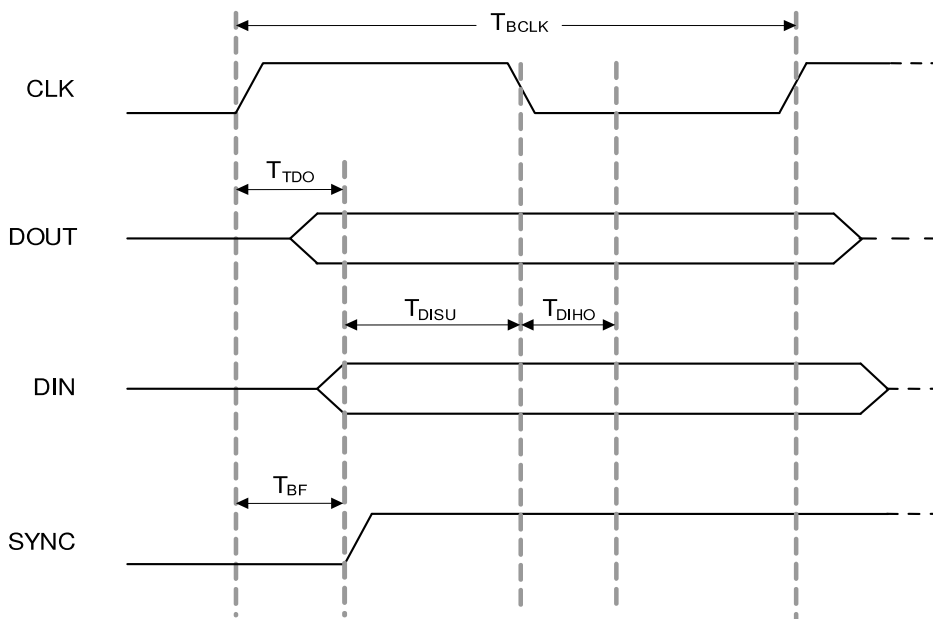
**Figure 9: PCM timing specification – Master mode**

Symbol	Parameter	Condition	Min.	Typ	Max.	Units
$F_{BCLK}$	-	-	-	2/2.048	-	MHz
Duty Cycle $_{BCLK}$	-	-	0.4	0.5	0.6	-
$T_{BCLK\ rise/fall}$	-	-	-	3	-	Ns
$T_{DO}$	-	-	-	-	15	ns
$T_{DISU}$	-	-	20	-	-	ns
$T_{DIHO}$	-	-	15	-	-	ns
$T_{BF}$	-	-	-	-	15	ns

**Table 9: PCM timing specification – Master mode**

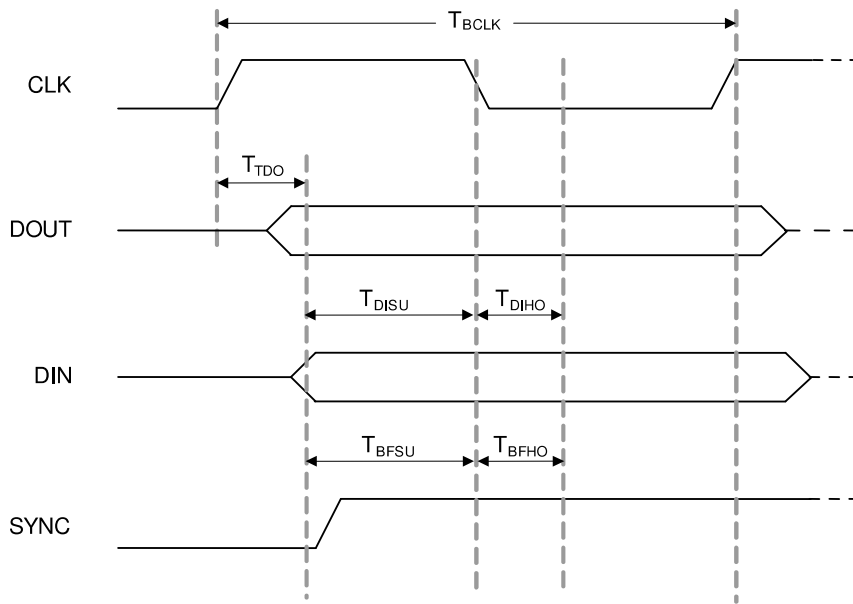
**Figure 10: PCM timing specification – Slave mode**

Symbol	Parameter	Condition	Min.	Typ	Max.	Units
$F_{BCLK}$	-	-	-	2/2.048	-	MHz
Duty Cycle <sub>BCLK</sub>	-	-	0.4	0.5	0.6	-
$T_{BCLK\ rise/fall}$	-	-	-	3	-	ns
$T_{DO}$	-	-	-	-	30	ns
$T_{DISU}$	-	-	15	-	-	ns
$T_{DIHO}$	-	-	10	-	-	ns
$T_{BFSU}$	-	-	15	-	-	ns
$T_{BFHO}$	-	-	10	-	-	ns

**Table 10: PCM timing specification – Slave mode**

## 2.5 GPIO interface

The General-Purpose I/O (GPIO) interface is used to implement user defined input and output signals to and from the 88W8887 chip such as external interrupts and other user-defined I/Os. Main features of the GPIO interface include:

- User-defined GPIO (each I/O configured to either input or output)
- Each GPIO independently controlled
- Each I/O configurable to output bit from GPIO\_OUT

The general functions associated with each GPIO pin is shown in Table 11:

GPIO Function	GPIO Pin																
	0	1	2	3	4	5	6	7	8	9	10	11	14	15	16	17	
<i>General</i>																	
Input	X	X	X	X	X	X	X	X	X	X	X	X	X	X	X	X	X
Output	X	X	X	X	X	X	X	X	X	X	X	X	X	X	X	X	X
<i>Interrupts</i>																	
Input	X	X	X	X	X	X	X	X	X	X	X	X	X	X	X	X	X

**Table 11: GPIO Functions – GPIO [17:14], [11:0]**

**⚠** GPIO\_12 and GPIO\_13 are not available.

## 2.6 JTAG interface

The Test interface pins are powered from the VIO2 voltage domain.

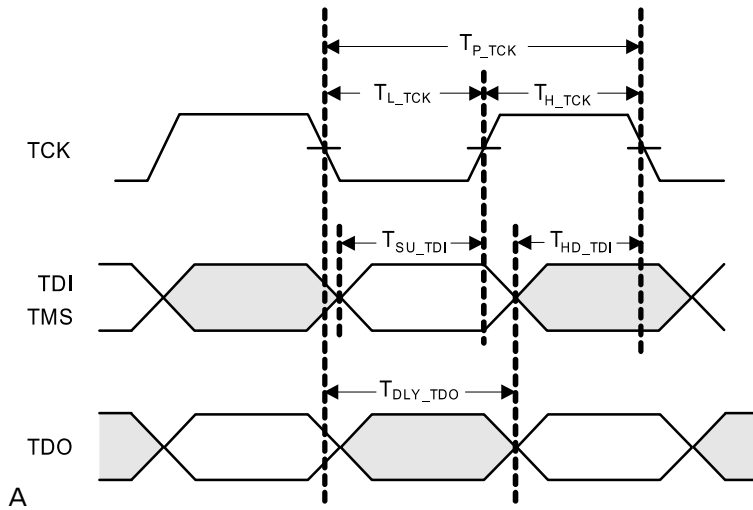

**Figure 11: JTAG Timing Diagram**

Symbol	Parameter	Condition	Min.	Typ	Max.	Units
$T_{P\_TCK}$	TCK period	-	40	-	-	ns
$T_{H\_TCK}$	TCK high	-	12	-	-	ns
$T_{L\_TCK}$	TCK low	-	12	-	-	ns
$T_{SU\_TDI}$	TDI, TMS to TCK setup time	-	10	-	-	ns
$T_{HD\_TDI}$	TDI, TMS to TCK hold time	-	10	-	-	ns
$T_{DLY\_TDO}$	TCK to TDO delay	-	0	-	15	ns

**Table 12: JTAG interface Timing Data**

## 3 Pin definition

### 3.1 Pin description

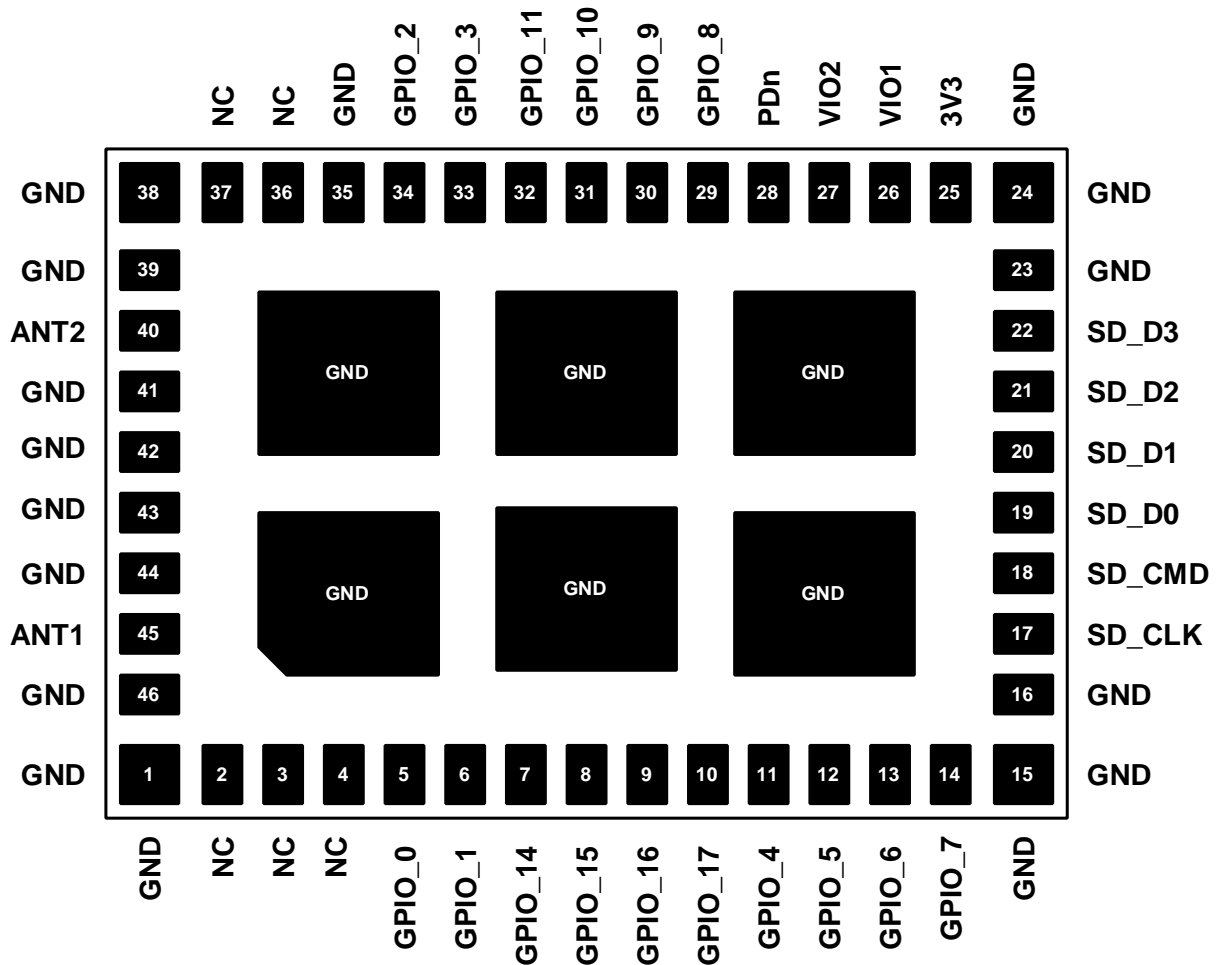

Figure 12: EMMY-W1 series pin assignment (top view)

No	Pin name	Pin type	Supply domain	Description
1	GND	Ground	-	Ground
2	NC	-	-	Reserved, do not connect
3	NC	-	-	Reserved, do not connect
4	NC	-	-	Reserved, do not connect
5	GPIO_0	I/O	VIO2	BT2HOST_WAKEUP (Output)
6	GPIO_1	I/O	VIO2	WL2HOST_WAKEUP (Output), Configuration pin (see section 3.3)
7	GPIO_14	I/O	VIO2	HOST2WL_WAKEUP / JTAG_TCK test clock (Input)
8	GPIO_15	I/O	VIO2	HOST2BT_WAKEUP / JTAG_TMS controller select (Input)
9	GPIO_16	I/O	VIO2	UART_LTE_SIN / JTAG_TDI test data input (Input)
10	GPIO_17	I/O	VIO2	UART_LTE_SOUT / JTAG_TDO test data output (Output)
11	GPIO_4	I/O	VIO2	PCM_DIN (Input)
12	GPIO_5	I/O	VIO2	PCM_DOUT (Output)
13	GPIO_6	I/O	VIO2	PCM_CLK (Input if slave, Output if master)

No	Pin name	Pin type	Supply domain	Description
14	GPIO_7	I/O	VIO2	PCM_SYNC (Input if slave, Output if master)
15	GND	Ground	-	Ground
16	GND	Ground	-	Ground
17	SD_CLK	I	VIO1	SDIO Clock input
18	SD_CMD	I/O	VIO1	SDIO Command line
19	SD_D0	I/O	VIO1	SDIO Data line bit [0]
20	SD_D1	I/O	VIO1	SDIO Data line bit [1]
21	SD_D2	I/O	VIO1	SDIO Data line bit [2]
22	SD_D3	I/O	VIO1	SDIO Data line bit [3]
23	GND	Ground	-	Ground
24	GND	Ground	-	Ground
25	3V3	Power	3.3V	3.3V Power supply (2.97 V - 3.63 V)
26	VIO1	Power	VIO1	VIO1 Power supply (1.62V - 1.98 V, 2.97 V - 3.63 V)
27	VIO2	Power	VIO2	VIO2 Power supply (1.62V - 1.98 V, 2.97 V - 3.63 V)
28	PDn	Input	-	Full power down(active low) <sup>6</sup>
29	GPIO_8	I/O	VIO2	UART_SOUT (Output), Configuration pin (se section 3.3)
30	GPIO_9	I/O	VIO2	UART_SIN (Input)
31	GPIO_10	I/O	VIO2	UART_CTSn (Input)
32	GPIO_11	I/O	VIO2	UART_RTSn (Output)
33	GPIO_3	I/O	3.3V	Configuration pin(see section 3.3), PCM_MCLK (output if master, input if slave)
34	GPIO_2	I/O	3.3V	Configuration pin (see section 3.3)
35	GND	Ground	-	Ground
36	NC		-	Reserved, do not connect
37	NC		-	Reserved, do not connect
38	GND	Ground	-	Ground
39	GND	Ground	-	Ground
40	ANT2	I/O, RF	-	Bluetooth antenna only in case of EMMY-W163 module. Not connected in case of EMMY-W161 or EMMY-W165 module <sup>7</sup>
41	GND	Ground	-	Ground
42	GND	Ground	-	Ground
43	GND	Ground	-	Ground
44	GND	Ground	-	Ground
45	ANT1	I/O, RF	-	Wi-Fi + Bluetooth antenna in case of single-antenna module. Wi-Fi antenna only in case of dual-antenna module <sup>7</sup>
46	GND	Ground	-	Ground
-	Exposed pin	Ground	-	Six Ground/Thermal exposed pins, connect to the ground

**Table 13: EMMY-W1 series pin description**

<sup>6</sup> High input impedance pin for minimizing shutdown current consumption. The pin shall be driven by the host controller or/and connected via 51 k $\Omega$  (or less) pull-up resistor to the 3.3 V supply rail.

<sup>7</sup> Pin protected from the static electricity by internal DC feed to the ground.

## 3.2 Reset configuration

The EMMY-W1 is reset to its default operating state under the following conditions:

- Power-on reset (POR) – Module receives power 3V3 supplies rise (triggers internal POR circuit)
- Software/Firmware reset
- External pin assertion (PDn) will generate POR.

## 3.3 Configuration pins

EMMY-W1 series modules are equipped with configuration pins. The configuration pins are characterized with special meaning during boot up, before the firmware is downloaded. The configuration pins are listed in Table 14. See Table 13 for a complete list of EMMY-W1 modules pins and their description.

Function	Pin Name	Pin Number	Power	Type	Signal Name	Remarks
<b>Digital</b>						
	<b>GPIO_8</b>	29	VIO2	O/ I (boot)	UART TX   Configuration pin	From the EMMY-W1 series module it must be read as high during boot up
	<b>GPIO_1</b>	6	VIO2	O/ I (boot)	WL2HOST wakeup   configuration pin	From the EMMY-W1 series module it must be read as high during boot up
	<b>GPIO_3</b>	33	3V3	I/O	Configuration pin   PCM_MCLK	To configure host interface and firmware download mechanism (see section 2.1)
	<b>GPIO_2</b>	34	3V3	ID	Configuration pin	To configure host interface and firmware download mechanism (see section 2.1)

**Table 14 Configuration pins for EMMY-W1 series modules**

## 4 Electrical specification

Stressing the device above one or more of the ratings listed in the Absolute Maximum Rating section may cause permanent damage. These are stress ratings only. Operating the module at these or at any conditions other than those specified in the Operating conditions section (section 4.2) of the specification should be avoided. Exposure to Absolute Maximum Rating conditions for extended periods may affect device reliability.

Operating condition ranges define those limits within which the functionality of the device is guaranteed. Where application information is given, it is advisory only and does not form part of the specification.

### 4.1 Absolute maximum ratings

Symbol	Description	Min.	Typ	Max.	Units
3V3	Power supply voltage 3.3 V	-	3.3	4.0	V
VIO1	I/O supply voltage 1.8 V		1.8	2.2	V
	I/O supply voltage 3.3 V		3.3	4.0	V
VIO2	I/O supply voltage 1.8 V	-	1.8	2.2	V
	I/O supply voltage 3.3 V		3.3	4.0	V
T <sub>STORAGE</sub>	Storage temperature	-40		+85	°C
C <sub>total</sub>	Total capacitance	-	58.6	-	µF

**Table 15: Absolute maximum ratings**

The product is not protected against overvoltage or reversed voltages. If necessary, voltage spikes exceeding the power supply voltage specification given in table above must be limited to values within the specified boundaries by using appropriate protection devices.

### 4.2 Operating conditions

Symbol	Parameter	Min.	Typ	Max.	Units
3V3	Power supply voltage 3.3 V	2.97	3.3	3.63	V
VIO1	I/O supply voltage 1.8V/3.3 V	1.62	1.8	1.98	V
		2.97	3.3	3.63	V
VIO2	I/O supply voltage 1.8V/3.3 V	1.62	1.8	1.98	V
		2.97	3.3	3.63	V
T <sub>A</sub>	Ambient operating temperature	-40	-	+85	°C
Ripple Noise	Peak-to-peak voltage ripple on 3V3, VIO1 or VIO2 supply line. The values have been determined in a frequency range from 10 KHz to > 2 MHz [3].	20	-		mV

**Table 16: Operating conditions**

Parameter	Min.	Typ	Max.	Units
Storage temperature	-40		+85	°C
Operation temperature	-40		+85	°C

**Table 17: Temperature range**

## 4.3 Digital pin ratings

Symbol	Parameter	Min.	Max.	Units
$V_{IH}$	Input high voltage	0.7*VIO	VIO+0.4	V
$V_{IL}$	Input low voltage	-0.4	0.3*VIO	V
$V_{HYS}$	Input hysteresis	100	-	mV
$V_{OH}$	Output high voltage	VIO-0.4	-	V
$V_{OL}$	Output low voltage	-	0.4	V
$I_{max}$	Maximum current consumption on each VIO domain	-	<5	mA

**Table 18: Digital pin ratings for VIO1 and VIO2 supply domains**

## 4.4 Wi-Fi power consumption

Operation mode: 2.4 GHz Wi-Fi TX/RX with BT in Deep Sleep mode	Average current, mA <sup>8</sup>
RX 11 Mbps	108
TX 11 Mbps (18 dBm)	320
TX 11 Mbps (8 dBm)	240
RX 54 Mbps	86
TX 54 Mbps (15 dBm)	263
TX 54 Mbps (8 dBm)	229
RX MCS7(HT40)	93
TX MCS7 (HT40, 15 dBm)	268
TX MCS7 (HT40, 8 dBm)	235

**Table 19: Wi-Fi current consumption during frame transmission for 2.4 GHz on channel 6**

Operation mode: 5 GHz Wi-Fi TX/RX with BT in Deep Sleep mode	Average current, mA <sup>8</sup>
RX 54 Mbps	77
TX 54 Mbps (16 dBm)	324
TX 54 Mbps (8 dBm)	238
RX MCS7 (HT20)	87
TX MCS7 (HT20, 16 dBm)	336
TX MCS7 (HT20, 8 dBm)	242
RX MCS7 (HT40)	106
TX MCS7 (HT40, 11 dBm)	268
TX MCS7 (HT40, 8 dBm)	248
RX MCS8 (VHT20)	91
TX MCS8 (VHT20, 11 dBm)	260
RX MCS9 (VHT40)	108
TX MCS9 (VHT40, 10 dBm)	267
RX MCS9 (VHT80)	148
TX MCS9 (VHT80, 8 dBm)	372

**Table 20: Wi-Fi current consumption during frame transmission for 5 GHz on channel 36**

<sup>8</sup> Supply 3.3 V. Current measurements during frame transmission. Numbers obtained with IPERF3 UDP traffic data pump.

Operation mode: Power save modes	Average current, mA
Power Down	0.03
WiFi and BT both in Deepsleep	0.17
WiFi DTIM 1 and BT Deepsleep	1.14
WiFi DTIM 3 and BT Deepsleep	0.47
WiFi DTIM 5 and BT Deepsleep	0.34

**Table 21: Wi-Fi power consumption**

## 4.5 Bluetooth power consumption

Bluetooth mode with Wi-Fi in deep sleep mode TX @ 0dBm	Average current, mA <sup>9</sup>
Deep Sleep Mode	0.17
BT idle	4.23
SCO HV3 Peak TX	18.75
SCO HV3 Peak RX	16.50
HV3 SCO mode ACL sniff 0x800	7.57
eSCO link, Master (2-EV3), ACL sniff 0x800	6.57
eSCO link, Master (EV3), ACL sniff 0x800	7.69
ACL (data pump) DH1	11.60
ACL (data pump) DH3	14.60
ACL (data pump) DH5	16.40
ACL Link, master sniff mode, interval=1.28s (800)	0.186
ACL Link, master sniff mode, interval=500ms (320)	0.278
SCO HV3 Average TX @ 4 dBm (external antenna)	7.83
SCO HV3 Peak TX @ 4 dBm (external antenna)	22.00
Interlaced scan (= P&I scan)	0.372
Page & Inquiry scan	0.667
Page Scan	0.293
Inquiry Scan	0.293
LE Advertise @ 1.28s interval	0.196
Peak LE TX	15.40
Peak LE RX	12.30
LE Link (interval=400=1.28s)	0.204
LE Link (interval=320=1.00s)	0.206
LE Scan (interval=800=1.28s)	0.281
LE Scan (interval=640=1.00s)	0.311

**Table 22: Bluetooth power consumption**

<sup>9</sup> Supply 3.3V, Average consumption current if not specified otherwise.

## 4.6 Radio specifications

**⚠** The values provided in this section might not comply with specific regulatory requirements. Further detailed information is provided in the EMMY-W1 series System Integration Manual [3].

### 4.6.1 Wi-Fi

The EMMY-W1 series modules support Wi-Fi standards IEEE 802.11a/b/g/n/ac in 2.4 GHz and 5 GHz radio bands. In the 2.4 GHz band, the EMMY-W1 supports 802.11b/g/n while in 5 GHz band, it supports 802.11a/n/ac.

Parameter	Operation Mode		Specification		
RF Frequency range	802.11b/g/n		2.400 – 2.500 GHz		
	802.11a/n/ac		5.150 – 5.850 GHz		
Modulation	802.11b		CCK and DSSS		
	802.11a/g/n/ac		OFDM		
Supported data rates	802.11b		1, 2, 5.5, 11 Mbps		
	802.11a/g		6, 9, 12, 18, 24, 36, 48, 54 Mbps		
	802.11n		MCS0 – MCS7 (150 Mbps)		
	802.11ac		MCS0 – MCS9 (433 Mbps)		
Supported channel bandwidth	802.11ac		20, 40, 80 MHz		
Supported guard interval (GI)	802.11n		400, 800 ms		
	802.11ac		Short guard interval supported		
Maximum transmit power	802.11b		18 dBm ± 1.5 dB		
	802.11a/g/n/ac		16 dBm ± 1.5 dB		
Minimum configurable transmit power	802.11b/a/g/n/ac		5 dBm (± 1.5 dB)		
Receiver sensitivity	2.4 GHz	802.11b	1 Mbps	-98 dBm ± 1 dB	
			11 Mbps	-89 dBm ± 1 dB	
		802.11g	6 Mbps	-91 dBm ± 1 dB	
			54 Mbps	-74 dBm ± 1 dB	
		802.11n	20 MHz	MCS0	-91 dBm ± 1 dB
				MCS7	-73 dBm ± 1 dB
	40 MHz		MCS0	-89 dBm ± 1 dB	
			MCS7	-71 dBm ± 1 dB	
	5 GHz	802.11a	6 Mbps	-91 dBm ± 1 dB	
			54 Mbps	-74 dBm ± 1 dB	
		802.11n	20 MHz	MCS0	-90 dBm ± 1 dB
				MCS7	-72 dBm ± 1 dB
			40 MHz	MCS0	-88 dBm ± 1 dB
				MCS9	-63 dBm ± 1 dB
802.11ac		80 MHz	MCS0	-85 dBm ± 1 dB	
			MCS9	-60 dBm ± 1 dB	

**Table 23: Wi-Fi radio specifications**

Channel	Frequency, GHz	Channel	Frequency, GHz	Channel	Frequency, GHz
1	2.412	6	2.437	11	2.462
2	2.417	7	2.442	12	2.467
3	2.422	8	2.447	13	2.472
4	2.427	9	2.452		
5	2.432	10	2.457		

**Table 24: 2.4 GHz Band Supported Channels, 20 MHz bandwidth**

Channel	Frequency, GHz	Channel	Frequency, GHz	Channel	Frequency, GHz
1 - 5	2.422	4 - 8	2.437	7 - 11	2.452
2 - 6	2.427	5 - 9	2.442		
3 - 7	2.432	6 - 10	2.447		

**Table 25: 2.4 GHz band supported channels, 40 MHz bandwidth**

Channel	Frequency, GHz	Channel	Frequency, GHz	Channel	Frequency, GHz
36	5.180	100	5.500	132	5.660
40	5.200	104	5.520	136	5.680
44	5.220	108	5.540	140	5.700
48	5.240	112	5.560	149	5.745
52	5.260	116	5.580	153	5.765
56	5.280	120	5.600	157	5.785
60	5.300	124	5.620	161	5.805
64	5.320	128	5.640	165	5.825

**Table 26: 5 GHz band supported channels, 20 MHz bandwidth**

Channel	Frequency, GHz	Channel	Frequency, GHz	Channel	Frequency, GHz
36 - 40	5.190	100 - 104	5.510	132 - 136	5.670
44 - 48	5.230	108 - 112	5.550	149 - 153	5.755
52 - 56	5.270	116 - 120	5.590	157 - 161	5.795
60 - 64	5.310	124 - 128	5.630		

**Table 27: 5 GHz band supported channels, 40 MHz bandwidth**

Channel	Frequency, GHz	Channel	Frequency, GHz	Channel	Frequency, GHz
42	5.210	106	5.530	138	5.690
58	5.290	122	5.610	155	5.775

**Table 28: 5 GHz band supported channels, 80 MHz bandwidth**

## 4.6.2 Bluetooth

Parameter	Specifications
RF Frequency Range	2.400 – 2.4835 GHz
Supported Modes	Bluetooth v4.2 (including Bluetooth Low Energy and Classic Bluetooth with BR and EDR)
Number of channels	79
Modulation	1 Mbps: GFSK (BR) 2 Mbps: $\pi/4$ DQPSK (EDR) 3 Mbps: 8DQPSK (EDR)
Transmit Power classic Bluetooth	Class 2, Class 1, BR: 10 dBm $\pm$ 2 dB, EDR: 8 dBm $\pm$ 2 dB <sup>10</sup>
Transmit Power BLE <sup>11</sup>	EMMY-W161: 7.8 dBm $\pm$ 2 dB EMMY-W165: 7.9 dBm $\pm$ 2 dB EMMY-W163: 9.3 dBm $\pm$ 2 dB
Receiver Sensitivity	EMMY-W161 (-97.5 dBm) $\pm$ 2 dB EMMY-W163 (-96.4 dBm) $\pm$ 2 dB EMMY-W165 (-97.9 dBm) $\pm$ 2 dB

**Table 29: Bluetooth radio specifications**

## 4.6.3 LTE co-existence

Specific influence of BAW filters on the following RF parameters:

- Wi-Fi output power
- Wi-Fi sensitivity
- Bluetooth output power
- Bluetooth sensitivity

Characterization of LTE co-existence:

- Maximum tolerated input power from LTE interferer
- Rejection in LTE bands
- Wi-Fi and Bluetooth desensitization in presence of LTE transmission in adjacent bands for given antenna isolation
- BAW decrease influence to LTE as well



The BAW-Filter is included only in the EMMY-W161 module variant.

<sup>10</sup> For regulatory reasons, only class 2 operations are permitted in Europe.

<sup>11</sup> Specified values are valid for the module pin configured with a target of 10 dBm.

## 5 Host drivers and firmware

### 5.1 General principle

The EMMY-W1 series modules does not contain any persistent software. A firmware binary will be downloaded by the host operating system driver on system start-up.

### 5.2 Supported operating systems

#### 5.2.1 Linux

Linux device drivers are available from u-blox. Once you sign the Limited Use License Agreement (LULA) with u-blox, a driver package will be available. This package includes:

- Dedicated Kernel driver, to bind the Wi-Fi and Bluetooth block to the kernel. The sources of those drivers will be provided.
- A dedicated firmware image, which will be uploaded during initialization.
- Various configuration tools
- Laboratory and manufacturing tools

For a detailed description of the driver packages, refer to EMMY-W1 series System Integration Manual [\[3\]](#).

#### 5.2.2 QNX

Support for the EMMY-W1 series modules is integrated with QNX in version 6.6 and 7.0. The driver package can be delivered via a customer project or a dedicated board support package (BSP). For further details, contact u-blox support for your area as listed in the Contact section on page 51.

## 6 Mechanical specifications

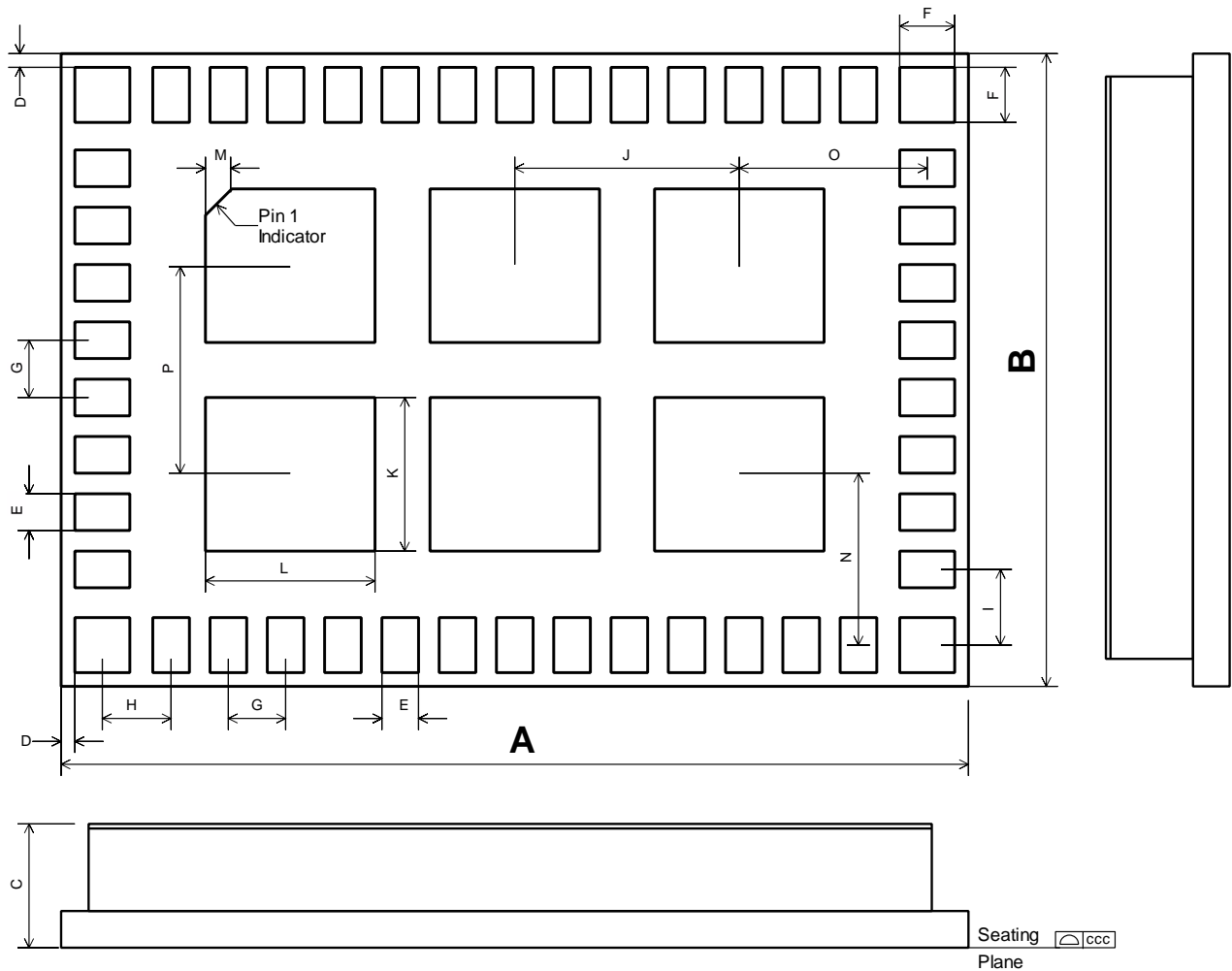

Figure 13: EMMY-W1 series dimensions (bottom view)

Parameter	Description	Typical		Tolerance	
A	Module Length [mm]	19.8	(779.5 mil)	+0.35/-0.1	(+13.8/-3.9 mil)
B	Module Width [mm]	13.8	(543.3 mil)	+0.1/-0.1	(+3.9/-3.9 mil)
C	Module Thickness [mm]	2.5	(98.4 mil)	+0.2/-0.2	(+7.9/-7.9 mil)
ccc	Seating Plane Coplanarity [mm]	0.1	(3.94 mil)		
D	PCB Edge to Pin Edge [mm]	0.3	(11.8 mil)	+0.20/-0.20	(+7.9/-7.9 mil)
E	Pin Width [mm]	0.8	(31.5 mil)	+0.05/-0.05	(+2.0/-2.0 mil)
F	Pin Length [mm]	1.2	(47.2 mil)	+0.05/-0.05	(+2.0/-2.0 mil)
G	Pin to Pin Pitch [mm]	1.25	(49.2 mil)	+0.02/-0.02	(+0.8/-0.8 mil)
H	Horizontal Corner Pin to Pin Pitch [mm]	1.5	(59.1 mil)	+0.02/-0.02	(+0.8/-0.8 mil)
I	Lateral Corner Pin to Pin Pitch [mm]	1.65	(65.0 mil)	+0.02/-0.02	(+0.8/-0.8 mil)
J	Horizontal Thermal Pads Pitch [mm]	4.9	(192.9 mil)	+0.02/-0.02	(+0.8/-0.8 mil)
K	Thermal Pad Height [mm]	3.35	(131.9 mil)	+0.1/-0.1	(+3.9/-3.9 mil)
L	Thermal Pad Length [mm]	3.7	(145.7 mil)	+0.1/-0.1	(+3.9/-3.9 mil)
M	Thermal Pad Pin 1 Mark Chamfer [mm]	0.6 x 45°	(23.6 mil x 45°)	+0.1/-0.1	(+3.9/-3.9 mil)

Parameter	Description	Typical		Tolerance	
N	Horizontal Pin to Thermal Pad Pitch [mm]	3.725	(146.7 mil)	+0.05/-0.05	(+2.0/-2.0 mil)
O	Lateral Pin to Thermal Pad Distance [mm]	4.1	(161.4 mil)	+0.05/-0.05	(+2.0/-2.0 mil)
P	Lateral Thermal Pads Pitch [mm]	4.55	(179.1 mil)	+0.02/-0.02	(+0.8/-0.8 mil)

## 7 Qualification and approvals

### 7.1 Country Approvals

Table 30 provides an overview of the available radio type approvals for each EMMY-W1 product variant.

Country/Region	EMMY-W161	EMMY-W161-A	EMMY-W163	EMMY-W163-A	EMMY-W165	EMMY-W165-A
EU (ETSI)	Yes	Yes	Yes	Yes	Yes	Yes
USA (FCC)	Yes	Yes	Yes	Yes	Yes	Yes
Canada (IC)	Yes	Yes	Yes	Yes	Yes	Yes
Australia (ACMA)	Yes	Yes	No	No	No	No
Korea (KCC)	No	No	Yes	Yes	No	No
Japan (Giteki)	Yes	Yes	Yes	Yes	No	No
Taiwan (NCC)	Yes	Yes	No	No	Yes	Yes
China (SRRC)	Yes	No	No	No	No	No

**Table 30: Overview of certifications for EMMY-W1 module series**

#### 7.1.1 European Union regulatory compliance

Information about regulatory compliance of the European Union for EMMY-W1 modules is available in the EMMY-W1 Declaration of Conformity [4].

##### 7.1.1.1 Compliance with the RoHS directive

EMMY-W1 series modules are RoHS compliant (Directive of the European Parliament and the Council on the Restriction of Use of certain Hazardous Substances in Electrical and Electronic Equipment). See the EMMY-W1 Declaration of Conformity [4] document for further details.

##### 7.1.1.2 Equipment classes

A multi-radio module is classified as class-1 or class-2 radio equipment depending on the frequency band in which it can operate. This equipment class is inherited by the end-product that integrates the module.

**Class-1** radio equipment can be placed on the market and put into service without restrictions. (Article 1 of Commission Decision 2000/299/EC of April 6 2000)

This multi-radio module is defined as class-1 radio equipment when it is restricted to operate in the following frequency bands:

- Bluetooth, ISM band 2400 – 2483.5 MHz
- WLAN, ISM band 2400 – 2483.5 MHz
- WLAN, U-NII bands 5470 – 5725 MHz and 5725 – 5825 MHz, excludes 5600 – 5650 MHz

**Class-2** radio equipment includes restrictions applied by Member States as indicated in Article 1(2) of the Commission Decision 2000/299/EC of April 6 2000. The class identifier as “information sign” or “alert sign”, required by the R&TTED, is not required by the RED and instead the manufacturer is required to provide information in accordance with Article 10.10 of the RED when restrictions on putting into service or of requirements for authorization of use exist in one or more Member States.

If an end product allows the multiradio module to operate in the 5150-5350 MHz band (WLAN channel: 36-64), it is defined as class-2 radio equipment.

 The usage of the EMMY-W1 series modules in a vehicular environment cannot be considered as “indoor” usage. The channels of the bands U-NII 1 and U-NII 2 are therefore not applicable.

A definition of subclasses of Class 2 equipment can be found in the Radio Equipment Directive (RED) [15].

The table below shows the restrictions when operating Wi-Fi at different bands within the European countries:

Band	Channel number	Channel frequency [MHz]	Indoor use allowed	Outdoor use allowed	Radio Equipment Class	Max. EIRP
ISM	1 – 11	2412 – 2462	Yes	Yes	1	100 mW / 20 dBm
U-NII 1	36 – 48	5180 – 5240	Yes	No	2	200 mW / 23 dBm
U-NII 2	52 – 64	5260 – 5320	Yes	No	2	200 mW / 23 dBm
U-NII 2e	100 – 140	5500 – 5700	Yes	Yes	1	1 W / 30 dBm
U-NII 3	149 – 165	5750 – 5825	Yes	Yes	1	25 mW / 14 dBm

**Table 31: Operating restrictions and radio equipment classification of EMMY-W1 series**

Guidance on how the end product is marked in accordance with the Radio Equipment Directive can be found in the Radio Equipment Directive (RED) [15].

**IMPORTANT:** The "CE" marking must be affixed on a visible location on the OEM product in which this module is installed and has to be labeled in accordance to Radio Equipment Directive 2014/53/EU.

### 7.1.1.3 Receiver Category

The EMMY-W1 series module complies with the EN 300 440 receiver category 2 (medium reliable short-range device communication media).

## 7.1.2 FCC compliance

The EMMY-W1 series module complies with Part 15 of the FCC Rules. Operation is subject to the following two conditions:

1. This device may not cause harmful interference, and
2. This device must accept any interference received, including interference that may cause undesired operation.

Non-authorized modification could void authority to use this equipment. The internal / external antenna(s) used for this module must provide a separation distance of at least 20 cm from all persons and must not be co-located or operating in conjunction with any other antenna or transmitter.

In accordance with 47 CFR § 15.19, the end product into which this module is integrated shall bear the following statement in a conspicuous location on the device:

This device complies with Part 15 of the FCC Rules. Operation is subject to the following two conditions:

1. This device may not cause harmful interference, and
2. This device must accept any interference received, including interference that may cause undesired operation.

When the end-product is so small or for such use that it is not practical to place the above statement on it, the information shall be placed in a prominent location in the instruction manual or pamphlet supplied to the user or on the container in which the device is marketed. However, the FCC ID label must be displayed on the device.

If the end-product will be installed in locations where the end-user is not able to see the FCC ID and/or this statement, the FCC ID and the statement shall also be included in the end-product manual.

The outside of final products containing the EMMY-W1 module must display in a user accessible area a label referring to the enclosed module. This exterior label can use wording such as the following: "Contains Transmitter Module FCC ID: (XYZ)(UPN)" or "Contains FCC ID:

(XYZ)(UPN)", where (XYZ) represents the FCC "Grantee Code" and (UPN) is the Unique Product Number decided by the grant owner<sup>12</sup>.

### 7.1.2.1 US FCC IDs

Product name	FCC ID
EMMY-W161	XPYEMMYW161
EMMY-W161-A	XPYEMMYW161
EMMY-W163	XPYEMMYW163
EMMY-W163-A	XPYEMMYW163
EMMY-W165	XPYEMMYW165
EMMY-W165-A	XPYEMMYW165

**Table 32: FCC IDs for different variants of EMMY-W1 series**

### 7.1.3 IC compliance

The EMMY-W1 series module complies with Industry Canada license-exempt RSSs. Operation is subject to the following two conditions:

1. This device may not cause interference, and
2. This device must accept any interference, including interference that may cause undesired operation of the device.

 Any notification to the end user of installation or removal instructions about the integrated radio module is NOT allowed. Unauthorized modification could void authority to use this equipment.

This equipment complies with IC RSS-102 radiation exposure limits set forth for an uncontrolled environment. This equipment should be installed and operated with minimum distance 20 cm between the radiator and your body.

This radio transmitter IC: 8595A-EMMYW161, IC: 8595A-EMMYW163 and IC: 8595A-EMMYW165 has been approved by Industry Canada to operate with the antenna types listed below with the maximum permissible gain indicated. Antenna types not included in this list, having a gain greater than the maximum gain indicated for that type, are strictly prohibited for use with this device.

 Operation in the band 5150–5250 MHz is only for indoor use to reduce the potential for harmful interference to co-channel mobile satellite systems;

 Operation in the 5600-5650 MHz band is not allowed in Canada. High-power radars are allocated as primary users (i.e. priority users) of the bands 5250-5350 MHz and 5650-5850 MHz and that these radars could cause interference and/or damage to LE-LAN devices.

The Industry Canada certification label of a module shall be clearly visible at all times when installed in the host device; otherwise, the host device must be labeled to display the Industry Canada certification number for the module, preceded by the words "Contains transmitter module", or the word "Contains", or similar wording expressing the same meaning, as follows: "Contains transmitter module IC: (CN)-(UPN)", where (CN) is the Company Number registered at Industry Canada and (UPN) is the Unique Product Number decided by the grant owner.



Le présent appareil est conforme aux CNR d'Industrie Canada applicables aux appareils radio exempts de licence. L'exploitation est autorisée aux deux conditions suivantes:

- (1) l'appareil ne doit pas produire de brouillage, et
- (2) l'utilisateur de l'appareil doit accepter tout brouillage radioélectrique subi, même si le brouillage est susceptible d'en compromettre le fonctionnement.

<sup>12</sup> The FCC and IC IDs for the EMMY-W1 series module variants are shown in Table 32 and Table 33. Select the applicable ID.

Cet équipement est conforme aux limites d'exposition de rayonnement d'IC RSS-102 déterminées pour un environnement non contrôlé. Cet équipement devrait être installé et actionné avec la distance minimum 20 cm entre le radiateur et votre corps.

Cet émetteur radio, IC: 8595A-EMMYW161, IC: 8595A-EMMYW163 et IC: 8595A-EMMYW165 été approuvé par Industry Canada pour fonctionner avec les types d'antenne énumérés ci-dessous avec le gain maximum autorisé et l'impédance nécessaire pour chaque type d'antenne indiqué. Les types d'antenne ne figurant pas dans cette liste et ayant un gain supérieur au gain maximum indiqué pour ce type-là sont strictement interdits d'utilisation avec cet appareil.

-  Le dispositif de fonctionnement dans la bande 5150-5250 MHz est réservé à une utilisation en intérieur pour réduire le risque d'interférences nuisibles à la co-canal systèmes mobiles par satellite
-  Opération dans la bande 5600-5650 MHz n'est pas autorisée au Canada. Haute puissance radars sont désignés comme utilisateurs principaux (c.-à. utilisateurs prioritaires) des bandes 5250-5350 MHz et 5650-5850 MHz et que ces radars pourraient causer des interférences et / ou des dommages à dispositifs LAN-EL.

L'étiquette d'homologation d'Industrie Canada d'un module donné doit être posée sur l'appareil hôte à un endroit bien en vue en tout temps. En l'absence d'étiquette, l'appareil hôte doit porter une étiquette sur laquelle figure le numéro d'homologation du module d'Industrie Canada, précédé des mots « Contient un module d'émission », ou du mot « Contient », ou d'une formulation similaire allant dans le même sens et qui va comme suit : « Contient le module d'émission IC: (CN)-(UPN) », où (CN) représente le numéro de compagnie, attribué par Industrie Canada et (UPN) représente le numéro de produit unique attribué par le requérant.

The internal / external antenna(s) used for this module must provide a separation distance of at least 20 cm from all persons and must not be co-located or operating in conjunction with any other antenna or transmitter. See Table 37 for list of approved antennas.

-  The approval type for all the EMMY-W1 series variants is a modular approval. Due to Industry Canada Modular Approval Requirements (Source: RSP-100 Issue 10), any application which includes the module must be approved by the module manufacturer (u-blox). The application manufacturer must provide design data for the review procedure.

### 7.1.3.1 Canada IC IDs

Product name	IC ID
EMMY-W161	8595A-EMMYW161
EMMY-W161-A	8595A-EMMYW161
EMMY-W163	8595A-EMMYW163
EMMY-W163-A	8595A-EMMYW163
EMMY-W165	8595A-EMMYW165
EMMY-W165-A	8595A-EMMYW165

Table 33: IC IDs for different variants of EMMY-W1 series

### 7.1.4 Australia and New Zealand regulatory compliance



The EMMY-W1 series modules are compliant with the standards made by the Australian Communications and Media Authority (ACMA). For detailed information about the obligations for end products market in Australia or New Zealand, refer to the EMMY-W1 series System Integration Manual [3].

## 7.1.5 Korean KCC compliance



MSIP-CRM-ULX-EMMY-W163

The EMMY-W1 series modules are certified by the Korea Communications Commission (KCC).

### 7.1.5.1 Korea KCC IDs

Product name	KCC ID
EMMY-W161	-
EMMY-W161-A	-
EMMY-W163	MSIP-CRM-ULX-EMMY-W163
EMMY-W163-A	MSIP-CRM-ULX-EMMY-W163
EMMY-W165	-
EMMY-W165-A	-

Table 34: KCC certification IDs for different variants of EMMY-W1 series

## 7.1.6 Japan radio equipment compliance

The EMMY-W1 series module complies with the Japanese Technical Regulation Conformity Certification of Specified Radio Equipment (ordinance of MPT N°. 37, 1981), Article 2, Paragraph 1:

- Item 19 "2.4 GHz band wide band low power data communication system"
- Item 19-3 "Low power data communications system in the 5.2/5.3 GHz band"
- Item 19-3-2 "Low power data communications system in the 5.6 GHz band"

The EMMY-W1 series module is restricted on the Japanese market to be used indoors only if the product is operating in the 5.2/5.3 GHz band.



この製品は屋内においてのみ使用可能です

Figure 14: Giteki mark, and the EMMY-W163 MIC certification number. The "Indoor use only" information translated into Japanese below is mandatory if the product is operating in the 5.2/5.3 GHz band.



この製品は屋内においてのみ使用可能です

Figure 15: Giteki mark, and the EMMY-W161 MIC certification number. The "Indoor use only" information translated into Japanese below is mandatory if the product is operating in the 5.2/5.3 GHz band.

### 7.1.6.1 Japan Giteki IDs

Product name	GITEKI ID
EMMY-W161	MIC ID: <span style="border: 1px solid black; padding: 0 2px;">R</span> 207-991006
EMMY-W161-A	MIC ID: <span style="border: 1px solid black; padding: 0 2px;">R</span> 207-991006
EMMY-W163	MIC ID: <span style="border: 1px solid black; padding: 0 2px;">R</span> 207-16EMMY
EMMY-W163-A	MIC ID: <span style="border: 1px solid black; padding: 0 2px;">R</span> 207-16EMMY
EMMY-W165	-
EMMY-W165-A	-

**Table 35: Giteki certification IDs for different variants of the EMMY-W1 series**

## 7.1.7 Taiwan NCC compliance

The EMMY-W1 series module has the applicable regulatory approvals for Taiwan (NCC).



### 7.1.7.1 Taiwan NCC warning statement

- 經型式認證合格之低功率射頻電機，非經許可，公司、商號或使用者均不得擅自變更頻率、加大功率或變更原設計之特性及功能。
- 低功率射頻電機之使用不得影響飛航安全及干擾合法通信；經發現有干擾現象時，應立即停用，並改善至無干擾時方得繼續使用。前項合法通信，指依電信法規定作業之無線電通信。低功率射頻電機須忍受合法通信或工業、科學及醫療用電波輻射性電機設備之干擾。

Statement translation:

- Without permission granted by the NCC, any company, enterprise, or user is not allowed to change frequency, enhance transmitting power or alter original characteristic as well as performance to an approved low power radio-frequency devices.
- The low power radio-frequency devices shall not influence aircraft security and interfere legal communications; If found, the user shall cease operating immediately until no interference is achieved. The said legal communications means radio communications is operated in compliance with the Telecommunications Act. The low power radio-frequency devices must be susceptible with the interference from legal communications or ISM radio wave radiated devices.

### 7.1.7.2 Taiwan NCC IDs

Product name	NCC ID
EMMY-W161	 CCAI17LP1950T3
EMMY-W161-A	
EMMY-W163	-
EMMY-W163-A	-
EMMY-W165	 CCAI17LP195AT5
EMMY-W165-A	

**Table 36 Taiwan certification IDs for different variants of the EMMY-W1 series**

## 7.1.8 China SRRC Radio Transmission Equipment compliance

The EMMY-W1 series module complies with the provisions on the Radio Regulations of the People's Republic of China.

### 7.1.8.1 China SRRC IDs

Product name	CMIIT ID
EMMY-W161	CMIIT ID: 2018AJ2699
EMMY-W161-A	-
EMMY-W163	-
EMMY-W163-A	-
EMMY-W165	-
EMMY-W165-A	-

Figure 16 China certification IDs for different variants of the EMMY-W1 series

## 7.2 Approved antennas

### 7.2.1 Wi-Fi / Bluetooth Dual Band Antennas

For Bluetooth and Wi-Fi operation in the 2.4 GHz band and Wi-Fi operation in the 5 GHz band, the module has been tested and approved for use with the antennas listed in Table 37.

Manufacturer	Part Number	Antenna type	Peak gain [dBi]		Validated Regulatory Domain
			2.4 GHz band	5 GHz band	
Antenova	A10194	SMD chip antenna 10x10x0.9 [mm] [5]	1.8	4.1	FCC/IC, ETSI, Giteki, ACMA, NCC
Antenova	SR42W001	SMD chip antenna 11.3x5.0x0.8 [mm] [16]	2.0	3.0	FCC/IC, ETSI, Giteki <sup>13</sup> , KCC
Linx	ANT-DB1-RAF-RPS	Dual-band dipole antenna [6]	2.5	4.6	FCC/IC, ETSI, Giteki, ACMA
Taoglas	GW.40.2153	Dual-band dipole antenna [7]	3.74	2.5	FCC/IC, ETSI, Giteki, ACMA
Taoglas	GW.59.3153	Dual-band dipole antenna [8]	2.37	2.93	FCC/IC, ETSI, Giteki, ACMA
Walsin	RFDPA870900 SBLB8G1	Dual-band dipole antenna [9]	2	3	FCC/IC, ETSI, Giteki, ACMA
Delock	88395	Dual-band dipole antenna [11]	1.5	2.1	FCC/IC, ETSI, Giteki, ACMA
Taoglas	GW.71.5153	Dual-band dipole antenna [17]	3.8	5.5	KCC, Giteki <sup>13</sup>
Art Signal	ARTS-SHWM-081	Wi-Fi Dual-band Antenna [18]	2.35	1.74	KCC, Giteki <sup>13</sup>
Taoglas	MA245.LBIC.002	Wi-Fi Dual-band Antenna [20]	3.46	3.42	Giteki <sup>13</sup>
Antenova	SRF2W021	Wi-Fi Dual-band Antenna [21]	2.8	5.1	KCC
Sycom	SJ245158SW 0303-A (B & W)	Wi-Fi Dual-band Antenna [22]	3	3	KCC

Table 37: List of approved dual-band antennas

The module can be integrated with other antennas which the OEM installer must authorize with respective regulatory agencies and after approval of the module manufacturer.

Important: To be compliant to FCC §15.407(a) the EIRP is not allowed to exceed 125 mW (21 dBm) at any elevation angle above 30 degrees as measured from the horizon when operated as an outdoor access point in U-NII-1 band, 5.150-5.250 GHz.

<sup>13</sup> Giteki EMMY-W161 and EMMY-W161-A only

 If in doubt if the antenna installation fulfills this requirement at maximum output power, restrict the maximum output power setting for operation in the 5.150-5.250 GHz band to 16 dBm. For a description on how to configure output power settings, refer to EMMY-W1 series System Integration Manual [3].

## 7.2.2 Bluetooth antenna

The following antennas are designated for Bluetooth transmission on EMMY-W163:

Manufacturer	Part Number	Antenna type	Peak gain [dBi] 2.4 GHz band	Validated Regulatory Domain
Johanson Technology	2450AT45A100	SMD chip antenna 10x10x0.9 [mm] [12]	2.2	FCC/IC, ETSI, Giteki, ACMA, KCC
Taoglas	GW.26.0151	Single-band monopole antenna [13]	1.8	FCC/IC, ETSI, Giteki, ACMA
Linx	ANT-2.4-CW-RCT-RP	Single-band dipole antenna [10]	2.2	FCC/IC, ETSI, Giteki, ACMA, KCC
Art Signal	ARTS-SHBM-082	Single-band monopole antenna [19]	-1.05	KCC
Linx	ANT-2.4-CW-RH	Single-band monopole antenna [14]	-0.9	FCC/IC, ETSI, Giteki, ACMA

**Table 38: List of approved single-band antennas**

## 7.3 Bluetooth qualification

 The EMMY-W1 series module is Bluetooth qualified as "Controller Subsystem" and is listed with the qualified design ID, QD ID: 87047.

This means that there is no need to do any further qualification if the module is combined with a host stack that is Bluetooth qualified as "Host Subsystem".

### 7.3.1 Bluetooth host stack

Several Bluetooth host stacks are available in the market. These host stacks are suited for different tasks and environments. These host stacks could differ based on their system requirements, supported Bluetooth profiles, cost, Bluetooth qualification, support and so on.

## 8 Product handling

### 8.1 Packaging

The EMMY-W1 series modules are delivered as hermetically sealed tape and reels, to enable efficient production, production lot set-up and tear-down. For more information about packaging, see the u-blox Package Information Guide [\[1\]](#).

#### 8.1.1 Reels

The EMMY-W1 series modules are deliverable in quantities of 500 pieces on a reel. The EMMY-W1 series modules are shipped on reel type A as described in the u-blox Package Information Guide [\[1\]](#).

#### 8.1.2 Tapes

[Figure 14](#) shows the position and orientation of the EMMY-W1 modules as they are delivered on tape. The dimensions of the tapes are specified in [Figure 18](#).

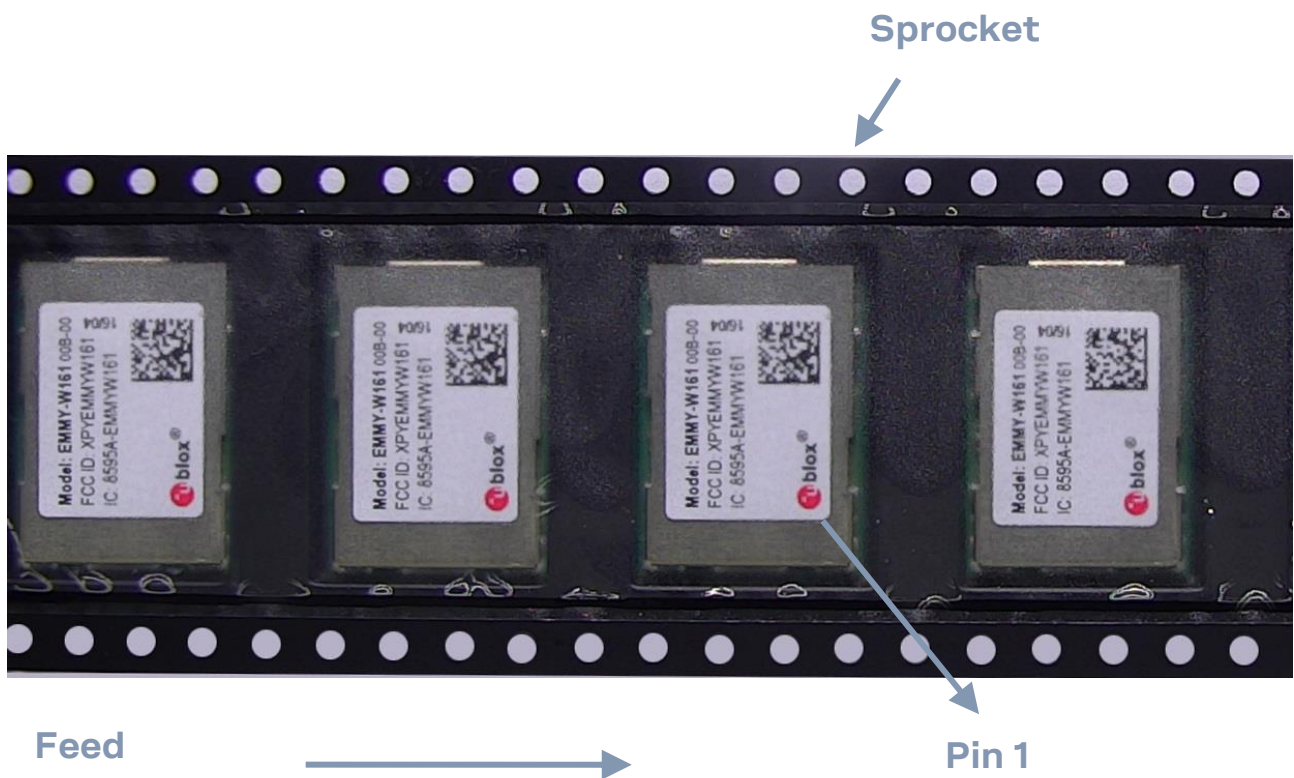
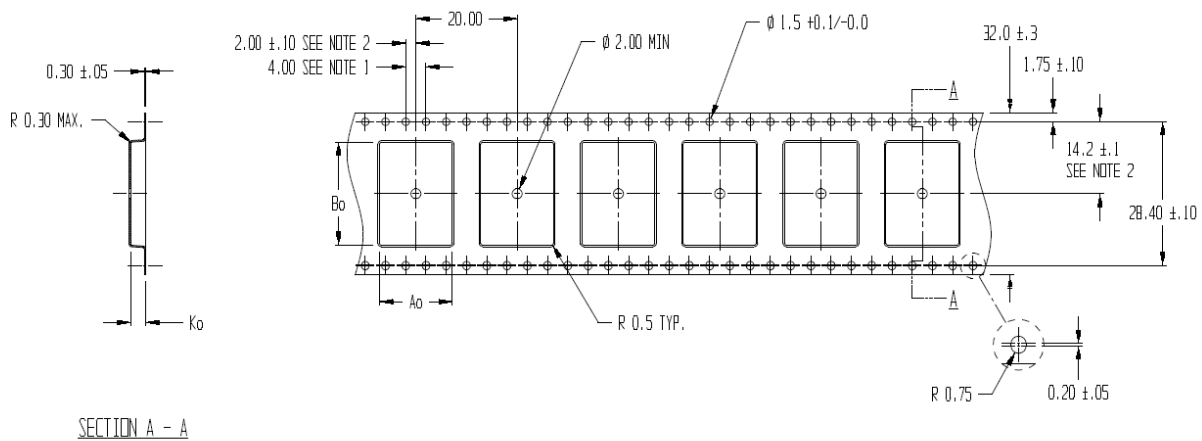

Figure 17: Orientation for EMMY-W1 modules on tape



$$\begin{aligned} A_0 &= 14.4 \\ B_0 &= 20.4 \\ K_0 &= 3.0 \end{aligned}$$

**NOTES:**

1. 10 SPROCKET HOLE PITCH CUMULATIVE TOLERANCE  $\pm 0.2$
2. POCKET POSITION RELATIVE TO SPROCKET HOLE MEASURED AS TRUE POSITION OF POCKET, NOT POCKET HOLE
3.  $A_0$  AND  $B_0$  ARE CALCULATED ON A PLANE AT A DISTANCE "R" ABOVE THE BOTTOM OF THE POCKET.

**Figure 18: EMMY-W1 Tape dimensions**

## 8.2 Shipment, storage and handling

For more information regarding shipment, storage and handling, see the u-blox Package Information Guide [1].

### 8.2.1 Moisture sensitivity levels

The EMMY-W1 series modules are rated at moisture sensitivity level 3. See moisture sensitive warning label on each shipping bag for detailed information. After opening the dry pack, modules must be mounted within 168 hours in factory conditions of maximum 30°C/60%RH or must be stored at less than 10%RH. Modules require baking if the humidity indicator card shows more than 10% when read at  $+23 \pm 5^\circ\text{C}$  or if the conditions mentioned above are not met. Please refer to J-STD-033B standard for bake procedure.

### 8.2.2 Mounting process and soldering recommendations

The EMMY-W1 series module is a surface mount module supplied on a 4-layer FR4-type PCB with gold plated connection pins and produced in a lead-free process with a lead-free soldering paste. The wrap page of the PCB is max. 0.75% according to IPC-A-610E. The thickness of solder resist on the host PCB top side and the EMMY-W1 bottom side must be considered for the soldering process.

This module is compatible with industrial reflow profile for RoHS/Pb-free solders, Sn96.5/Ag3.0/Cu0.5 solder is a right choice. Use of "No Clean" soldering paste is strongly recommended, cleaning the populated modules is strongly discouraged - residuals under the module cannot be easily removed with any cleaning process. Cleaning with water can lead to capillary effects where water is absorbed into the gap between the host board and module. The combination of soldering flux residuals and encapsulated water could lead to short circuits between neighboring pins.

Only a single reflow soldering process is permitted for host boards with the EMMY-W1 series modules.

The reflow profile used is dependent on the thermal mass of the entire populated PCB, heat transfer efficiency of the oven and particular type of solder paste used. Since the profile used is process and layout dependent, the optimum profile should be studied case by case. Recommendations below

should be taken as a starting point guide. In case of basic information necessity, refer to the J-STD-020C standard. }

Profile feature	Sn-Pb eutectic (Sn63/Pb37)	RoHS/Pb-free (Sn96.5/Ag3.0/Cu0.5)
Ramp up rate ( $T_{SMAX}$ to $T_P$ )	3 °C/sec max	3 °C/sec max
Minimum soak temperature ( $T_{SMIN}$ )	100 °C	150 °C
Maximum soak temperature ( $T_{SMAX}$ )	150 °C	200 °C
Soak time ( $t_s$ )	60 - 120 sec	60 - 180 sec
Liquidus temperature ( $T_L$ )	183 °C	217 °C
Time above $T_L$ ( $t_L$ )	60 - 150 sec	60 - 150 sec
Peak temperature ( $T_P$ )	215 – 225 °C	235 – 245 °C
Time within +0 / -5°C of actual TP ( $t_p$ )	10 - 30 sec	20 - 40 sec
Ramp down rate	6 °C/sec max	6 °C/sec max
Time from +25 °C to $T_P$	6 min max	8 min max

**Table 39: Recommended reflow profile**

The lowest value of  $T_P$  and slower ramp down rate (2 – 3 °C/sec) is preferred.

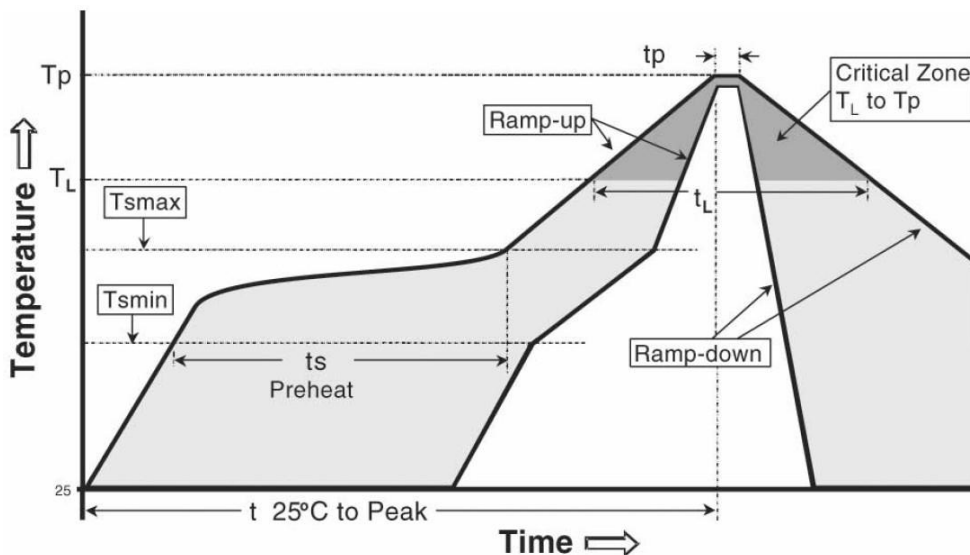

**Figure 19: Reflow profile**

### 8.2.3 ESD handling precautions

EMMY-W1 series modules are Electrostatic Sensitive Devices (ESD). Observe precautions for handling! Failure to observe these precautions can result in severe damage to the Wi-Fi receiver!

Wi-Fi transceivers are Electrostatic Sensitive Devices (ESD) and require special precautions when handling. Particular care must be exercised when handling patch antennas, due to the risk of electrostatic charges. In addition to standard ESD safety practices, the following measures should be taken into account whenever handling the receiver:

- Unless there is a galvanic coupling between the local GND (i.e. the work table) and the PCB GND, then the first point of contact when handling the PCB must always be between the local GND and PCB GND.
- Before mounting an antenna patch, connect ground of the device



- When handling the RF pin, do not come into contact with any charged capacitors and be careful when contacting materials that can develop charges (e.g. patch antenna ~10 pF, coax cable ~50-80 pF/m, soldering iron, ...)
- To prevent electrostatic discharge through the RF input, do not touch any exposed antenna area. If there is any risk that such exposed antenna area is touched in non ESD protected work area, implement proper ESD protection measures in the design.
- When soldering RF connectors and patch antennas to the receiver's RF pin, make sure to use an ESD safe soldering iron (tip).

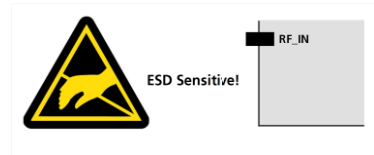

## 9 Labeling and ordering information

### 9.1 Product labeling

The labels of EMMY-W1 series include important product information as described in this section. The data matrix code for automotive and professional grade variants of EMMY-W1 series includes a serial number.

#### 9.1.1 EMMY-W161

Figure 20 illustrates a sample label of the automotive grade (professional grade is similar and differs with respect to the product version 1 as mentioned in Table 41) of the EMMY-W161 module and includes the following - the u-blox logo, product name (model), type number, FCC and IC certification number, NCC mark and ID, Gitaki mark and ID and the date of unit production encoded YY/WW (year/week).

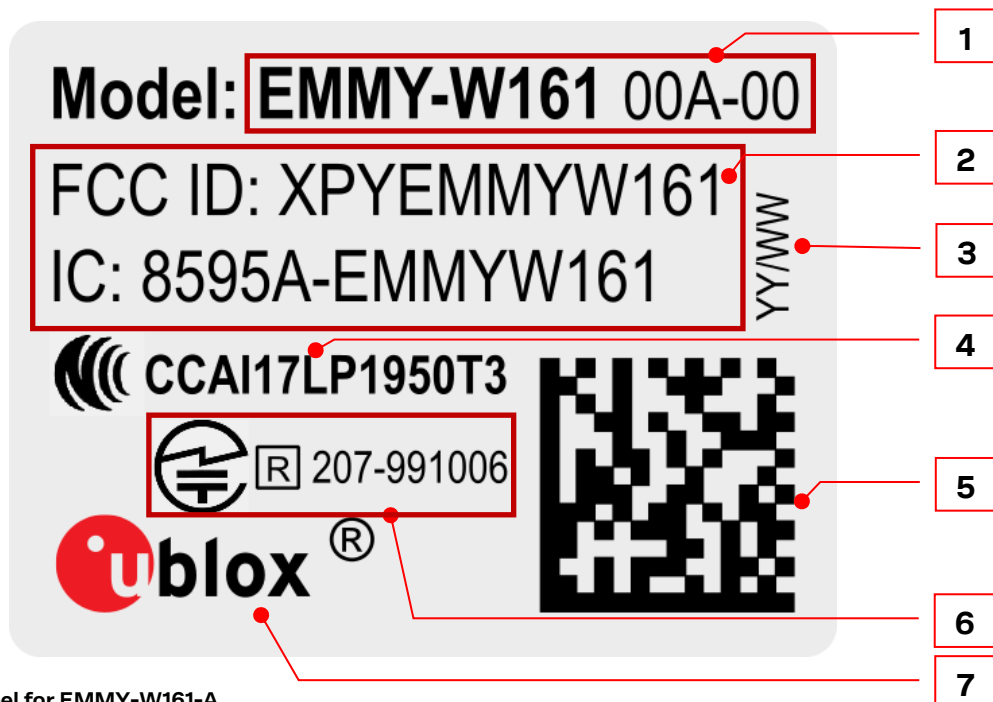

Figure 20: Sample label for EMMY-W161-A

Reference	Description
1	Text "MODEL:" followed by product type number, excluding the second dash and smaller font used for the product version identifier (For example, "xxB-yy" for professional and "xxA-yy" for automotive grade).
2	Certification IDs (FCC/IC) with which the module has been listed with
3	Date of production encoded YY/WW (year/week)
4	NCC mark and ID
5	Data Matrix with unique serial number of 19 alphanumeric symbols. The 3 first symbols represent the unique module type no: 631: EMMY-W161-00A-00 701: EMMY-W161-00B-00 The next 12 symbols represent the unique hexadecimal Bluetooth MAC address (see section 1.7 for more information about MAC addresses) of the module AABBCCDDEEFF, and the last 4 symbols represent the hardware and firmware version encoded HHFF.
6	GITEKI mark and ID
7	u-blox logo, the red dot in the logo is also marking pin no 1

Table 40 Label description for EMMY-W161

### 9.1.2 EMMY-W163

Figure 21 illustrates a sample label of the automotive grade (professional grade is similar and differs with respect to product version 1 as mentioned in Table 41) of the EMMY-W1 series and includes the following - the u-blox logo, product name (model), type number, FCC and IC certification number, KCC and GITEKI mark and ID, and the date of unit production encoded YY/WW (year/week).

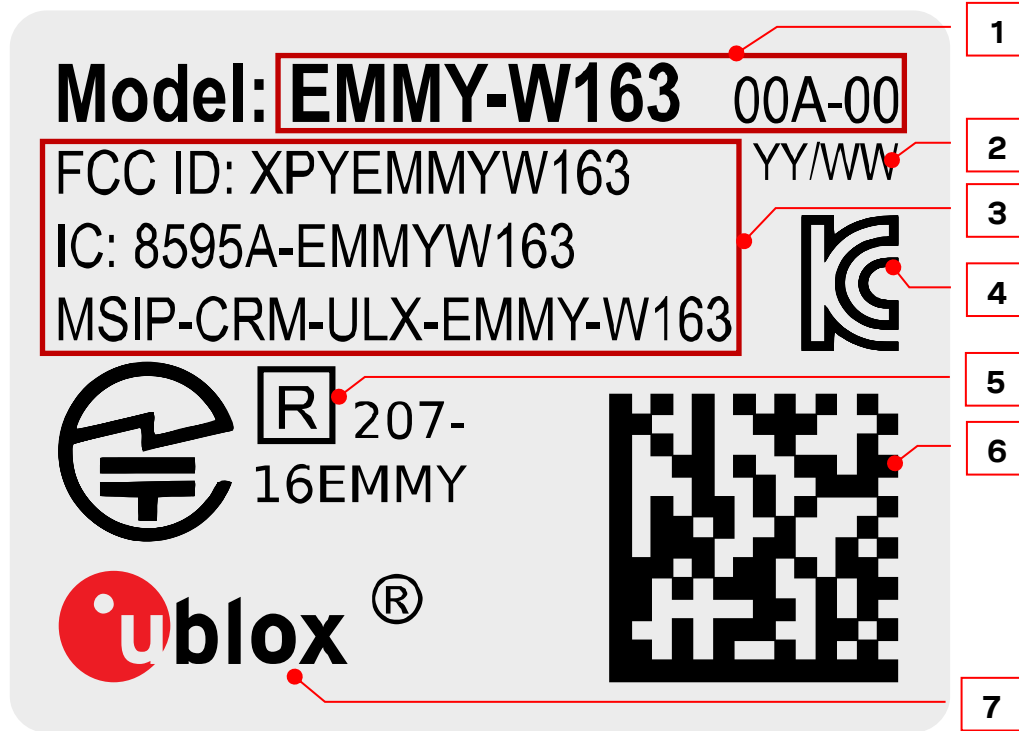

Figure 21: Sample label for EMMY-W163-A

A detailed description of the label components are listed in Table 41. The first three digits of the serial number represent the Bluetooth MAC address.

Reference	Description
1	Text "MODEL:" followed by product type number, excluding the second dash and smaller font used for the product version identifier (For example, "xxB-yy" for professional and "xxA-yy" for automotive grade).
2	Date of production encoded YY/WW (year/week)
3	Certification IDs (FCC/IC, KCC) with which the module has been listed with
4	KC mark for Korea KCC certification
5	GITEKI mark and ID
6	Data Matrix with unique serial number of 19 alphanumeric symbols. The 3 first symbols represent the unique module type no: 632: EMMY-W163-00A-00 700: EMMY-W163-00B-00 The next 12 symbols represent the unique hexadecimal Bluetooth MAC address (see section 1.7 for more information about MAC addresses) of the module AABBCDDDEEFF, and the last 4 symbols represent the hardware and firmware version encoded HFFF.
7	u-blox logo, the red dot in the logo is also marking pin no 1

Table 41 Label description for EMMY-W163

### 9.1.3 EMMY-W165

Figure 22 illustrates a sample label of the automotive grade (professional grade is similar and differs with respect to the product version 1 as mentioned in Table 41) of the EMMY-W165 module and includes the following - the u-blox logo, product name (model), type number, FCC and IC certification number, NCC mark and ID and the date of unit production encoded YY/WW (year/week).



Figure 22: Sample label for EMMY-W165-A

Reference	Description
1	Text "MODEL:" followed by product type number, excluding the second dash and smaller font used for the product version identifier (For example, "xxB-yy" for professional and "xxA-yy" for automotive grade).
2	Certification IDs (FCC/IC) with which the module has been listed with
3	Date of production encoded YY/WW (year/week)
4	NCC mark and ID
5	Data Matrix with unique serial number of 19 alphanumeric symbols. The 3 first symbols represent the unique module type no: 756: EMMY-W165-00A-00 841: EMMY-W165-00B-00 The next 12 symbols represent the unique hexadecimal Bluetooth MAC address (see section 1.7 for more information about MAC addresses) of the module AABBCCDDEEFF, and the last 4 symbols represent the hardware and firmware version encoded HHFF.
6	u-blox logo, the red dot in the logo is also marking pin no 1

Table 42 Label description for EMMY-W165

## 9.2 Explanation of codes

Two different product code formats are used. The **Product Name** is used in documentation such as this data sheet and identifies all u-blox products, independent of packaging and quality grade. The **Ordering Code** includes options and quality, while the **Type Number** includes the hardware and firmware versions. Table 43 below details these three different formats:

Format	Structure
Product Name	PPPP-TGVV
Ordering Code	PPPP-TGVV-TTQ
Type Number	PPPP-TGVV-TTQ-XX

**Table 43: Product code formats**

[Table 44](#) explains the parts of the product code.

Code	Meaning	Example
PPPP	Form factor	EMMY
TG	Platform T – Dominant technology, For example, W: Wi-Fi, B: Bluetooth G - Generation	W1
VV	Variant based on the same platform; range [00...99]	61
TT	Major Product Version	00
Q	Quality grade A: Automotive B: Professional C: Standard	A
XX	Minor product version (not relevant for certification)	00

**Table 44: Part identification code**

## 9.3 Ordering codes

Ordering Code	Product name	Product
EMMY-W161-00B	EMMY-W161	EMMY-W161 professional grade module
EMMY-W161-00A	EMMY-W161-A	EMMY-W161 automotive grade module
EMMY-W163-00B	EMMY-W163	EMMY-W163 professional grade module
EMMY-W163-00A	EMMY-W163-A	EMMY-W163 automotive grade module
EMMY-W165-00B	EMMY-W165	EMMY-W165 professional grade module
EMMY-W165-00A	EMMY-W165-A	EMMY-W165 automotive grade module
EVK-EMMY-W161-A	EVK-EMMY-W161	Evaluation kit for EMMY-W161 and EMMY-W161-A as well as EMMY-W165 and EMMY-W165-A when not co-located with LTE
EVK-EMMY-W163-A	EVK-EMMY-W163	Evaluation kit for EMMY-W163 and EMMY-W163-A

**Table 45: Product ordering codes**

Product changes affecting form, fit or function are documented by u-blox. For a list of Product Change Notifications (PCNs), see our website.

# Appendix

## A Glossary

Abbreviation	Definition
AES	Advanced Encryption Standard
ARM	Arm (Advanced RISC Machines) Holdings
ACMA	Australia Communications and Media Authority
AEC	Automotive Electronics Council
BPF	Band-Pass Filter
BBR	Battery Backed RAM
BER	Bit Error Rate
BLE	Bluetooth Low Energy
BSP	Board Support Package
BAW	Bulk Acoustic Wave
CPU	Central Processing Unit
CE	Certification Mark for EHS compliance in the European Economic Area
CLK	Clock
UTC	Coordinated Universal Time
DCE	Data Circuit-terminating Equipment* / Data Communication Equipment*
DTE	Data Terminal Equipment
DC	Direct Current
DSSS	Direct Sequence Spread Spectrum
DRX	Discontinuous Reception
DDC	Display Data Channel* / Digital Down Converter?*
DL	Down Link (Reception)
EIRP	Effective Isotropic Radiated Power
ESD	Electrostatic Discharge* / Electrostatic Sensitive Device*
ETSI	European Telecommunications Standards Institute
EU	European Union
EVK	Evaluation Kit
FCC	Federal Communications Commission
FIFO	First In First Out
GPIO	General Purpose Input/Output
GND	Ground
I/O	Input/Output
IPC	Institute for Interconnecting and Packaging Electronic Circuits
IEEE	Institute of Electrical and Electronics Engineers
IC	Integrated Circuit
ISO	International Organization for Standardization
JTAG	Joint Test Action Group
LGA	Land Grid Array

Abbreviation	Definition
LED	Light Emitting Diode
LTE	Long-Term Evolution
M2M	Machine to Machine
MAC	Media Access Control
NFC	Near Field Communication
OTP	One-Time Programmable (memory)
OEM	Original Equipment Manufacturer
POR	Power-On Reset
PCB	Printed Circuit Board
PCN	Product Change Notification
PCM	Pulse Code Modulation
QNX	Quantum Software Systems real-time operating system
RED	Radio Equipment Directive (EU)
RF	Radio Frequency
RSS	Radio Standards Specifications (Canada)
RAM	Random Access Memory
RX	Receive Signal
SDIO	Secure Digital Input Output
SMD	Solder Mask Defined
SMA	SubMiniature version A connector
TP	Test Point
TDI	Time Delay and Integration?
TA	Timing Advance
TIS	Total Isotropic Sensitivity
TX	Transmit Signal
UBX	u-blox proprietary messaging protocol
UART	Universal Asynchronous Receiver/Transmitter
WLAN	Wireless Local Area Network (IEEE 802.11 short range radio technology)

**Table 46: Explanation of the abbreviations and terms used**

## Related documents

- [1] u-blox Package information guide, doc. no. [UBX-14001652](#)
- [2] Driver software application note for ELLA-W1 series and EMMY-W1 series, doc. no. [UBX-15012542](#)
- [3] EMMY-W1 series system integration manual, doc. no. [UBX-15024929](#)
- [4] EMMY-W1 declaration of conformity, doc. no. [UBX-16007139](#)
- [5] Mixtus A10194 Product Specification, Antenova-M2M, [www.antenova-m2m.com/documents/download/40c67cf2e7a4c7b8cd0f7faed7f6d2ca4fe1886d597d5](http://www.antenova-m2m.com/documents/download/40c67cf2e7a4c7b8cd0f7faed7f6d2ca4fe1886d597d5), October 2015
- [6] [ANT-DB1-RAF-xxx Data Sheet, Linx, www.linxtechnologies.com/resources/data-guides/ant-db1-raf-xxx.pdf](#), October 2015
- [7] Specification. Part No.: GW.40.2153, taoglas, [fccid.io/pdf.php?id=2415249](http://fccid.io/pdf.php?id=2415249), December 2015
- [8] Specification. Part No.: GW.59.3153, taoglas, [www.taoglas.com/images/product\\_images/original\\_images/GW.59.3153-2.4GHz-5.8GHzBandMountDipoleAntenna080910.pdf](http://www.taoglas.com/images/product_images/original_images/GW.59.3153-2.4GHz-5.8GHzBandMountDipoleAntenna080910.pdf), October 2015
- [9] 2015 RF Devices and High Frequency Inductors Product catalog, [www.passivecomponent.com/document/HF\\_Devices/2013RF\\_Catalogue.pdf](http://www.passivecomponent.com/document/HF_Devices/2013RF_Catalogue.pdf), December 2015
- [10] ANT-2.4-CW-RCT-xx Data Sheet, Linx, [www.linxtechnologies.com/resources/data-guides/ant-2.4-cw-rct-xx.pdf](http://www.linxtechnologies.com/resources/data-guides/ant-2.4-cw-rct-xx.pdf), October 2015
- [11] Delock WLAN 802.11 ac/a/b/g/n Antenna RP-SMA 2 dBi Omnidirectional Joint, 2015-11-26 [www.delock.com/produkt/88395/pdf.html?sprache=en](http://www.delock.com/produkt/88395/pdf.html?sprache=en), November 2015
- [12] 2.45 GHz High Gain SMD Chip Antenna P/N 2450AT45A100, Johanson Technology, [www.johansontechnology.com/datasheets/antennas/2450AT45A100.pdf](http://www.johansontechnology.com/datasheets/antennas/2450AT45A100.pdf), October 2015
- [13] 2.4 GHz Miniature Screw mount Monopole Antenna, Taoglas, [www.taoglas.com/images/product\\_images/original\\_images/GW.26.01122.4GHzBandMonopoleSMA%28M%29RA.pdf](http://www.taoglas.com/images/product_images/original_images/GW.26.01122.4GHzBandMonopoleSMA%28M%29RA.pdf), December 2015
- [14] ANT-2.4-CW-RH Data Sheet, Linx, [www.linxtechnologies.com/resources/data-guides/ant-2.4-cw-rh-xxx.pdf](http://www.linxtechnologies.com/resources/data-guides/ant-2.4-cw-rh-xxx.pdf), December 2015
- [15] The Radio Equipment Directive RED; [http://ec.europa.eu/growth/sectors/electrical-engineering/red-directive\\_en](http://ec.europa.eu/growth/sectors/electrical-engineering/red-directive_en); July 2017
- [16] ULTRA COMPACT DUAL-BAND WI-FI: MUTICA SMD ANTENNA; [www.antenova-m2m.com/product/mutica-ultra-compact-dual-band-wi-fi-antenna-pn-sr42w001/](http://www.antenova-m2m.com/product/mutica-ultra-compact-dual-band-wi-fi-antenna-pn-sr42w001/); July 2017
- [17] GW.71.5153 - 2.4GHz/5.8GHz Dipole Antenna for ISM Band and WLAN; [www.taoglas.com/wp-content/uploads/2015/04/GW.71.5153.pdf](http://www.taoglas.com/wp-content/uploads/2015/04/GW.71.5153.pdf); December 2017
- [18] H532B – Wi-Fi Dual Antenna Product Specification, ARTS-SHWM-081; Art Signal; Re. 1.0 2017-01-06
- [19] H532B – Bluetooth 2.4GHz Antenna Product Specification, ARTS-SHWM-082; Art Signal; Re. 1.0 2017-01-06
- [20] MA245.LBIC.002 - Genesis 4in1 GNSS, 2\*LTE & WiFi Low Profile Adhesive Mount Antenna, SPE-18-8-061/A/AW, Taoglas
- [21] SRF2W021 – Amoris Dual-band Wi-Fi Antenna, SRF2W021-PS-1.4, Antenova
- [22] SJ245158SW0303-A (B) -Black-, SJ245158SW0303-A (W) -White-, 2400-2483/5158-5850 MHz 3/3 dBi Rubber Duck Antenna, Sycom



For regular updates to u-blox documentation and to receive product change notifications, register on our homepage ([www.u-blox.com](http://www.u-blox.com)).

# Revision history

Revision	Date	Name	Comments
R01	16-Mar-2015	lalb	Initial draft release.
R02	16-Oct-2015	shoe, ishe, kfra, ovik, ddie, kgom	Professional grade variants added. Minor updates in section 1.6. Modified figures 2, 11 and 12. Included subsections 2.2, 2.4 and 4.6. Included Table 7 in section 2.3, Table 9 in section 2.4.1 and Table 10 in Section 2.5. Updated Tables 2, 10, 11, 18, and 23. Renamed section 2.5 as GPIO interface. Added information for the sections 2.3, 2.4 and 2.5. Removed section 4.4 - Current consumption from R01. Added section 3.2 – Reset configuration, section 4.4 - Wi-Fi power consumption, section 4.5 - Bluetooth power consumption and section 4.6 - NFC power consumption. Removed VIO1/2 from PDn description. Added maximum ratings for NFC_ANT_N/P pins. Added note with respect to availability of BAW in EMMY-W161 variant only. Updated features to include compliance with Bluetooth 4.2. Included sample labels for professional and automotive grade variants in section 9.1. Modified Wi-Fi standards support in section 4.7.1. Included NFC specifications and packaging information in section 4.7.4 and 8.1 respectively. Minor change in section 7.1.3 – IC compliance. Modified the top view drawing in Figure 12. Added info about upcoming country approvals for Japan, South Korea, China, Taiwan and Australia. Added section 7.2 – Approved antennas. Provided reference to EMMY-W1 series System Integration Manual for information about driver packages in section 5.2.1. Updated planned FCC and IC IDs in Table 34 and on the label (Figure 21 and 17). Included Receiver Sensitivity information in Table 29.
R03	9-Dec-2015	shoe, ishe, kgom	Modified section 1.6.1. In section 1.6.1, included footnote that IEEE 802.11k and v is not supported by the firmware currently in the first bullet. Removed "applies only to automotive grade variants" from the last bullet in section 1.6.3 as ISO 16750 will apply for both the variants. Added section 1.7. In sections 4.6.1 and 4.6.2, modified the specifications for maximum transmit power and receiver sensitivity. Updated Table 30 in section 7.1.3.1. Updated section 7.1.3.1. Modified the Note in section 7.1.1.3 - "FCC Compliance". Modified the last note in section 7.1.2.1.
R04	19-Jul-2016	shoe, kgom	Early Production Information document status. Specified the final FCC and IC IDs (Table 34). Added measured ripple noise values. Updated label description with matrix code information (section 9.1). Included information about EMMY-W165 product variant. Added information about the restrictions for U-NII band 3 in Table 31.
R05	15-Dec-2016	shoe, lalb, kgom	Corrected the description of the data matrix code on the module label (Table 41) and added EMMY-W165-00B to the table. Removed the note that states "FCC, ETSI and IC certifications are in progress" as they are completed now. Updated power consumption values for Wi-Fi, Bluetooth and Bluetooth low energy (sections 4.4 and 4.5). Added BT QDID (section 7.3). Added maximum current consumption for VIO related PINS (section 4.3). Updated Bluetooth sensitivity value (section 4.6.2). Added PCM_MCLK as optional function for GPIO3 (section 3.1). Updated tolerance for mechanical specifications (section 6). Added footnote to explain exclusion of frequencies 5600-5650 for ETSI in section 7.1.1. Added KCC IDs and compliance notes (section 7.1.5 and 7.4). Added Australia and New Zealand compliance notes (section 7.1.3.1). Added Japan GITEKI compliance notes (section 7.5 and 7.1.5.1). Added tape orientation information (section 8.1.2). Moved the Declaration of Conformity information to a separate EMMY-W1 Declaration of Conformity document (section 7.1.1). Replaced Document status with Disclosure restriction.
R06	29-Mar-2017	ddie, shoe, kgom	Updates due to specification changes by the radio chip supplier (PCN reference UBX-17005747): Removed NFC functionality. Reduced maximum clock to 150 MHz for SDIO 3.0 interface. Updated product status to Mass Production for the professional grade modules. Added requirement for outdoor use as a Wi-Fi access point in the 5.15-5.25 GHz band (section 7.1.6.1). Removed LED functionality description as this is not supported by the driver. Added QNX driver support information.
R07	14-Sep-2017	shoe	Updated section 7.1.1 and included reference to the new Radio Equipment Directive RED. Added DualBand chip antenna antenova SR42W001 to the list of approved dual-band antennas in Table 37. In Related documents section, provided reference to RED in related documents [15]. Added obligation comment for vehicular environments and remove alert sign obligation information in section

Revision	Date	Name	Comments
			7.1.1. Added BLE output power values to section 4.6.2. Added JTAG pin description to section 3. Added JTAG timing description with section 2.6.
R08	14-Aug-2018	shoe, kgom	Updated product status to Mass Production for the automotive grade modules. Added total capacitance in Table 15. Added NCC compliance (sections 7.1.6.1 and 7.6). Added NCC ID to the module label for variants EMMY-W161 and EMMY-W165 (section 9.1). Added "Validated Regulatory Domain" information for the approved antennas in Table 37 and Table 38. Updated Bluetooth sensitivity values (section 4.6.2). Added information for the receiver category 2 (section 7.1.1.3). Updated QNX support (section 5.2.2). Added section 3.3 to clarify the usage of Configuration pins. Added SRRC compliance information (section 7.1.7.2 and section 7.7).
R09	18-Sep-2018	lalb	Removed "planned" from the last bullet item in section 1.6.3 (as the automotive qualification test has been completed).
R10	02-Oct-2018	shoe	<del>Updated SDR104 timing diagram in section 2.2.3 (<math>T_{OP,max}</math> and <math>T_{ODW,min}</math> changed to be relative to <math>T_{CLK}</math>).</del> NOTE: Revision R10 changes are reverted in revision R11 as they were incorrect.
R11	27-Aug-2019	mzes, lalb	Added Giteki (Japan) compliance for EMMY-W161 (section 7.1.6). Updated label for EMMY-W161 to include Giteki ID (section 9.1.1). Restructured section 7. Added Antenova SRF2W021 and Sycom SJ245158SW0303-A to the list of approved dual-band antennas in Table 37. Updated Table 1. Reverted revision R10 changes (related to SDR104 timing $T_{OP}$ and $T_{ODW}$ ) which were incorrect.

# Contact

For complete contact information, visit us at [www.u-blox.com](http://www.u-blox.com).

## u-blox Offices

### North, Central and South America

#### u-blox America, Inc.

Phone: +1 703 483 3180  
E-mail: [info\\_us@u-blox.com](mailto:info_us@u-blox.com)

#### Regional Office West Coast:

Phone: +1 408 573 3640  
E-mail: [info\\_us@u-blox.com](mailto:info_us@u-blox.com)

#### Technical Support:

Phone: +1 703 483 3185  
E-mail: [support@u-blox.com](mailto:support@u-blox.com)

### Headquarters

#### Europe, Middle East, Africa

#### u-blox AG

Phone: +41 44 722 74 44  
E-mail: [info@u-blox.com](mailto:info@u-blox.com)  
Support: [support@u-blox.com](mailto:support@u-blox.com)

### Asia, Australia, Pacific

#### u-blox Singapore Pte. Ltd.

Phone: +65 6734 3811  
E-mail: [info\\_ap@u-blox.com](mailto:info_ap@u-blox.com)  
Support: [support\\_ap@u-blox.com](mailto:support_ap@u-blox.com)

#### Regional Office Australia:

Phone: +61 2 8448 2016  
E-mail: [info\\_au@u-blox.com](mailto:info_au@u-blox.com)  
Support: [support\\_ap@u-blox.com](mailto:support_ap@u-blox.com)

#### Regional Office China (Beijing):

Phone: +86 10 68 133 545  
E-mail: [info\\_cn@u-blox.com](mailto:info_cn@u-blox.com)  
Support: [support\\_cn@u-blox.com](mailto:support_cn@u-blox.com)

#### Regional Office China (Chongqing):

Phone: +86 23 6815 1588  
E-mail: [info\\_cn@u-blox.com](mailto:info_cn@u-blox.com)  
Support: [support\\_cn@u-blox.com](mailto:support_cn@u-blox.com)

#### Regional Office China (Shanghai):

Phone: +86 21 6090 4832  
E-mail: [info\\_cn@u-blox.com](mailto:info_cn@u-blox.com)  
Support: [support\\_cn@u-blox.com](mailto:support_cn@u-blox.com)

#### Regional Office China (Shenzhen):

Phone: +86 755 8627 1083  
E-mail: [info\\_cn@u-blox.com](mailto:info_cn@u-blox.com)  
Support: [support\\_cn@u-blox.com](mailto:support_cn@u-blox.com)

#### Regional Office India:

Phone: +91 80 405 092 00  
E-mail: [info\\_in@u-blox.com](mailto:info_in@u-blox.com)  
Support: [support\\_in@u-blox.com](mailto:support_in@u-blox.com)

#### Regional Office Japan (Osaka):

Phone: +81 6 6941 3660  
E-mail: [info\\_jp@u-blox.com](mailto:info_jp@u-blox.com)  
Support: [support\\_jp@u-blox.com](mailto:support_jp@u-blox.com)

#### Regional Office Japan (Tokyo):

Phone: +81 3 5775 3850  
E-mail: [info\\_jp@u-blox.com](mailto:info_jp@u-blox.com)  
Support: [support\\_jp@u-blox.com](mailto:support_jp@u-blox.com)

#### Regional Office Korea:



Phone: +82 2 542 0861  
E-mail: [info\\_kr@u-blox.com](mailto:info_kr@u-blox.com)  
Support: [support\\_kr@u-blox.com](mailto:support_kr@u-blox.com)

#### Regional Office Taiwan:







Phone: +886 2 2657 1090  
E-mail: [info\\_tw@u-blox.com](mailto:info_tw@u-blox.com)  
Support: [support\\_tw@u-blox.com](mailto:support_tw@u-blox.com)

## Looking for pricing, stock, or lifecycle information?

Click below to explore more details on WIN SOURCE:

-  [View EMMY-W161-00B on WIN SOURCE](#)
-  [U-blox Information](#)

## Optimize Your Supply Chain with WIN SOURCE Solutions

-  Global Sourcing Solution
-  Obsolete Management
-  Cost Control Management
-  Shortage Management
-  Alternative Solution
-  Excess Inventory Management