

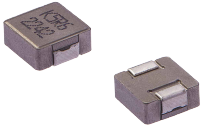

**THE DATASHEET OF
MDA7030-2R2**



MDA Series
SMD Low Profile High Current Molded Inductor
Size 7030



FEATURES

- Shielded construction
- Capable of corresponding high frequency .
- Low loss realized with low DCR.
- High performance (Isat) realized by metal dust core.
- Ultra low buzz noise, due to composite construction.
- 100% Lead(Pb)-Free and RoHS compliant.
- AEC-Q200 qualified
- Operating temperature: -55 to +155 °C (including self-temperature rise)
- Quantity: 1000PCS

APPLICATION

- Headlamps, tail lamps and interior lighting
- HVAC
- Doors, window lift and seat control
- Audio subsystem
- Digital instrument cluster
- In-Vehicle Infotainment and navigation

Dimensions: [mm]

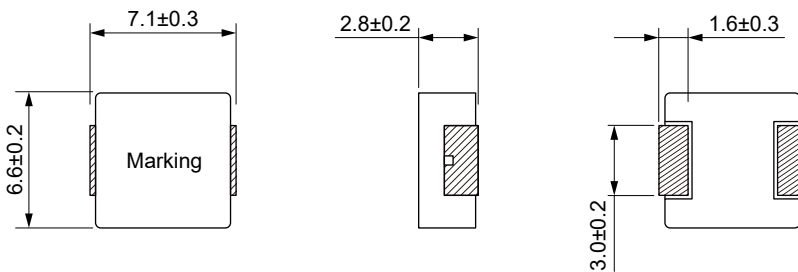

Land Pattern: [mm]

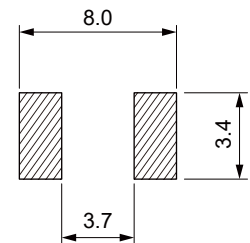

Electrical Properties:

| Part No | Inductance @ 100KHz/1V (μH) | Tolerance | Temperature Rise Current Typ. (A) | Temperature Rise Current Max. (A) | Saturation Current Typ. (A) | Saturation Current Max. (A) | DC Resistance Typ. (mΩ) | DC Resistance Max. (mΩ) |
|--------------|-----------------------------|-----------|-----------------------------------|-----------------------------------|-----------------------------|-----------------------------|-------------------------|-------------------------|
| MDA7030-R15N | 0.15 | ±30% | 30.0 | 25.0 | 40.0 | 36.0 | 1.70 | 2.10 |
| MDA7030-R22M | 0.22 | ±20% | 23.0 | 21.0 | 34.0 | 32.0 | 2.00 | 2.50 |
| MDA7030-R33M | 0.33 | ±20% | 21.0 | 20.0 | 25.0 | 22.0 | 2.80 | 3.40 |
| MDA7030-R36M | 0.36 | ±20% | 20.0 | 18.0 | 24.0 | 21.0 | 3.30 | 3.90 |
| MDA7030-R47M | 0.47 | ±20% | 18.0 | 16.0 | 20.0 | 18.0 | 3.40 | 4.00 |
| MDA7030-R56M | 0.56 | ±20% | 16.5 | 15.0 | 18.0 | 16.0 | 3.90 | 4.50 |
| MDA7030-R68M | 0.68 | ±20% | 16.0 | 14.5 | 17.0 | 15.0 | 4.70 | 5.30 |
| MDA7030-R82M | 0.82 | ±20% | 14.0 | 13.0 | 16.0 | 14.0 | 5.40 | 6.00 |
| MDA7030-1R0M | 1.00 | ±20% | 12.0 | 11.0 | 15.0 | 13.5 | 6.70 | 7.40 |
| MDA7030-1R2M | 1.20 | ±20% | 10.0 | 9.5 | 14.0 | 12.5 | 7.70 | 9.50 |

| Part No | Inductance @ 100KHz/1V (μH) | Tolerance | Temperature Rise Current Typ. (A) | Temperature Rise Current Max. (A) | Saturation Current Typ. (A) | Saturation Current Max. (A) | DC Resistance Typ. (mΩ) | DC Resistance Max. (mΩ) |
|--------------|-----------------------------|-----------|-----------------------------------|-----------------------------------|-----------------------------|-----------------------------|-------------------------|-------------------------|
| MDA7030-1R5M | 1.50 | ±20% | 10.0 | 9.0 | 14.0 | 12.0 | 10.2 | 12.1 |
| MDA7030-2R2M | 2.20 | ±20% | 8.0 | 7.5 | 10.0 | 9.0 | 13.5 | 15.0 |
| MDA7030-3R3M | 3.30 | ±20% | 6.5 | 6.0 | 9.5 | 8.5 | 19.0 | 22.0 |
| MDA7030-4R7M | 4.70 | ±20% | 5.5 | 5.0 | 6.5 | 5.5 | 28.0 | 33.0 |
| MDA7030-5R6M | 5.60 | ±20% | 5.5 | 5.0 | 6.0 | 5.2 | 39.0 | 42.0 |
| MDA7030-6R8M | 6.80 | ±20% | 4.5 | 4.2 | 6.0 | 5.0 | 43.0 | 50.0 |
| MDA7030-8R2M | 8.20 | ±20% | 4.5 | 4.0 | 6.0 | 4.7 | 54.0 | 60.0 |
| MDA7030-100M | 10.0 | ±20% | 4.0 | 3.5 | 5.5 | 4.5 | 62.0 | 68.0 |
| MDA7030-150M | 15.0 | ±20% | 3.0 | 2.5 | 4.5 | 4.0 | 110 | 140 |
| MDA7030-220M | 22.0 | ±20% | 2.5 | 2.0 | 3.0 | 2.5 | 150 | 190 |
| MDA7030-330M | 33.0 | ±20% | 2.1 | 1.8 | 2.5 | 2.0 | 215 | 258 |
| MDA7030-470M | 47.0 | ±20% | 1.5 | 1.2 | 2.0 | 1.6 | 318 | 385 |

Saturation Current will cause L to drop approximately 30%

Temperature Rise Current: The actual value of DC current when the temperature rise is $\Delta T=40^{\circ}\text{C}$

Typical Electrical Characteristics:

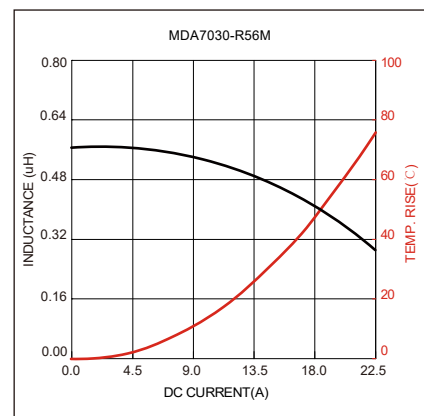
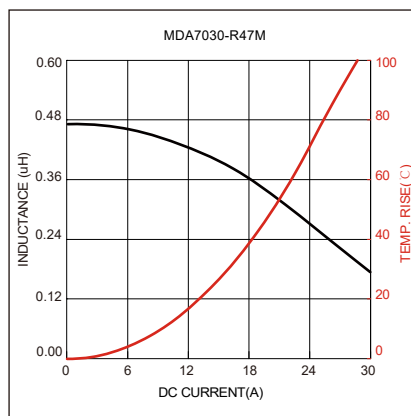
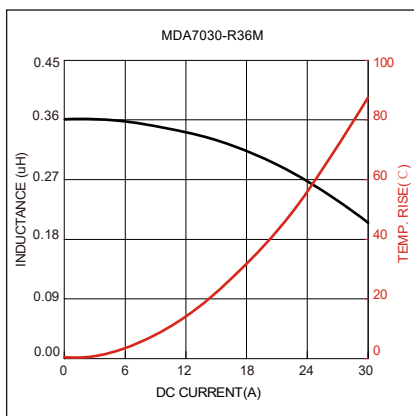
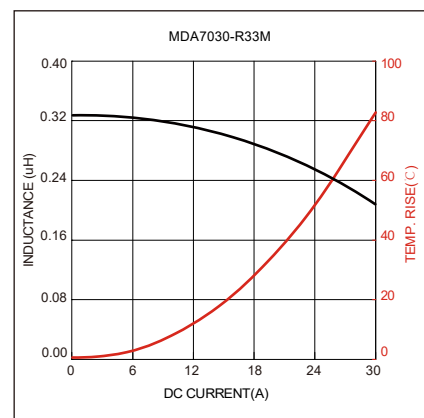
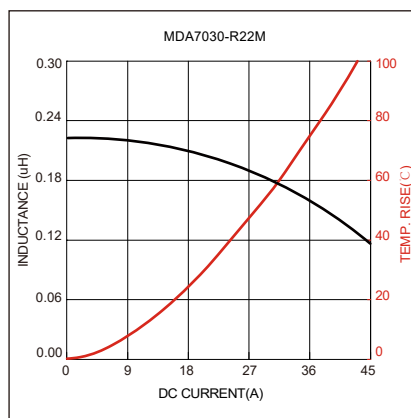
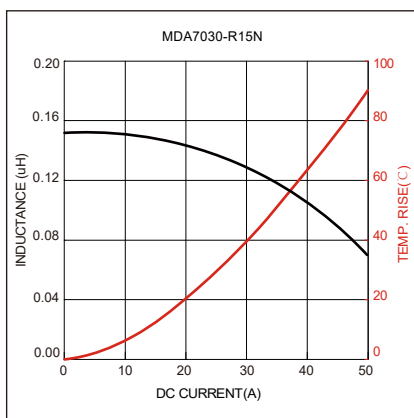

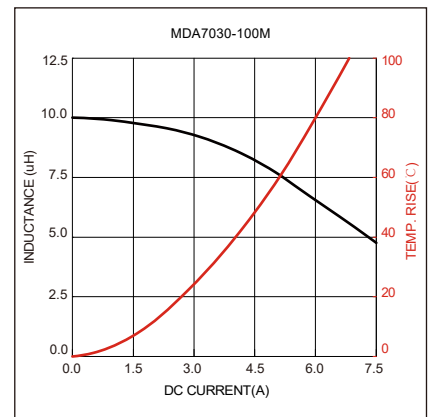
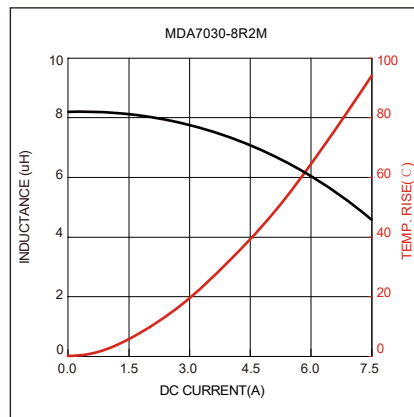
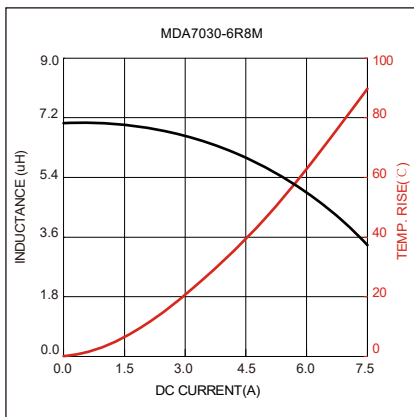
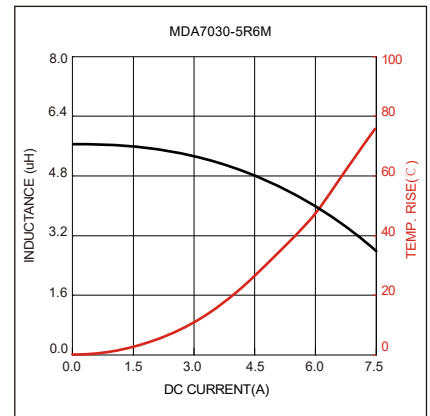
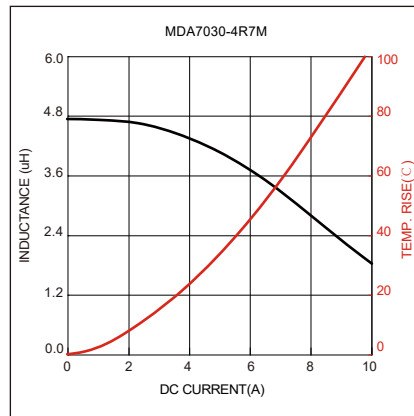
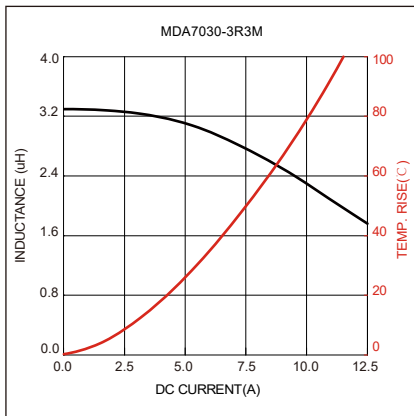
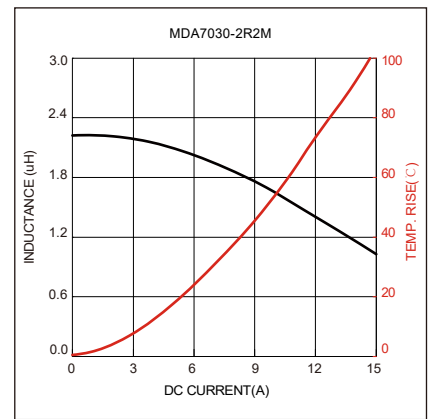
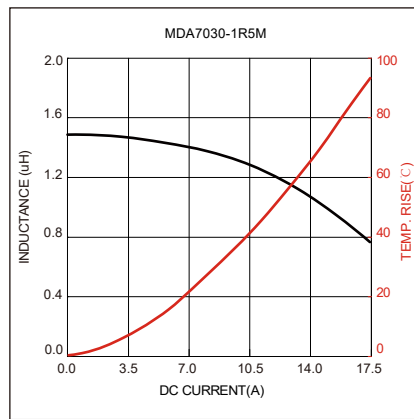
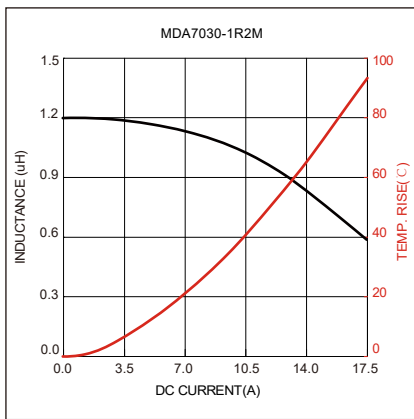
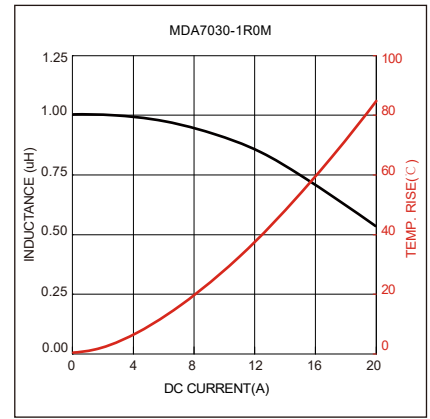
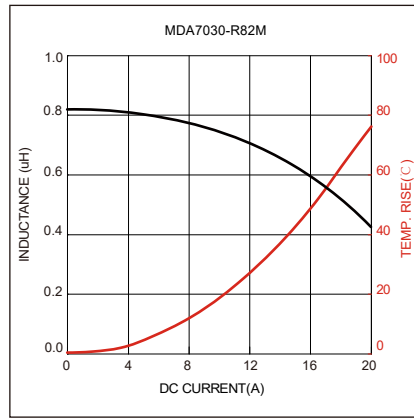
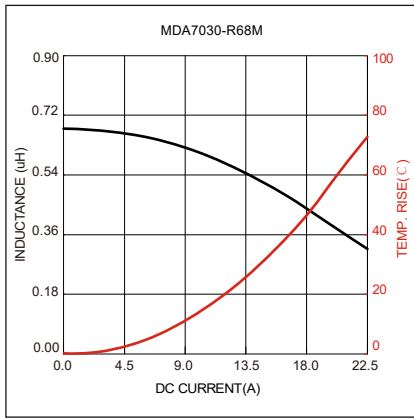

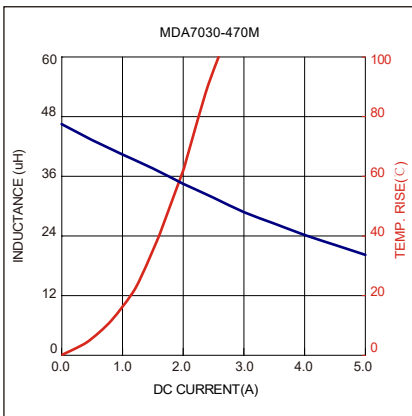
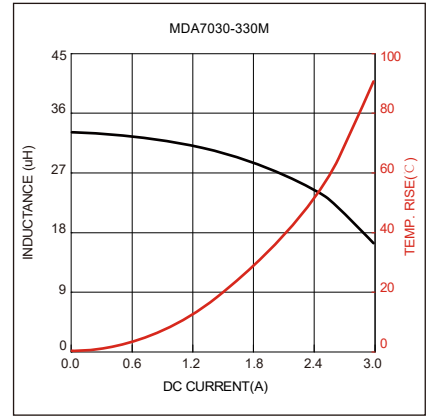
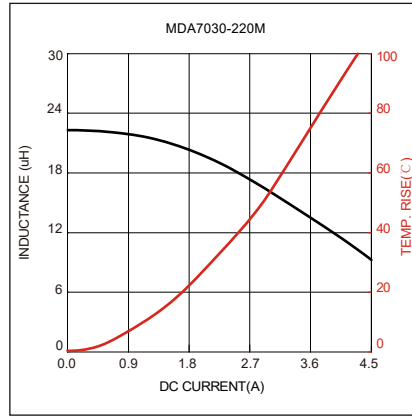
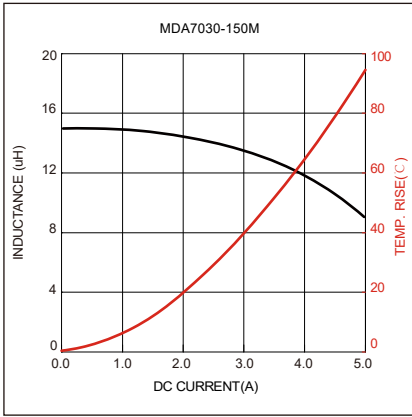

Soldering Reflow:

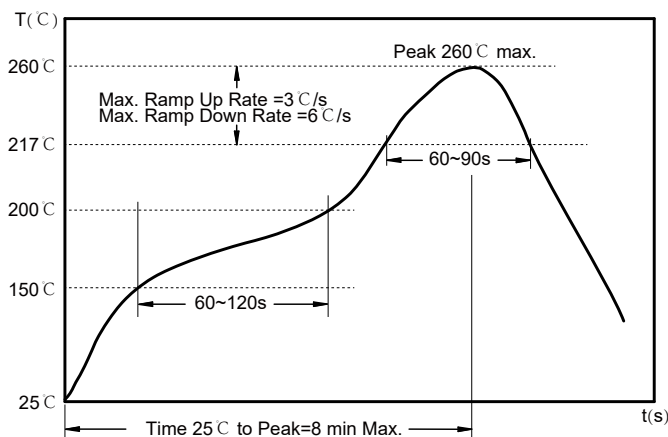

Preheat condition: 150 ~200°C / 60~120 sec.
 Allowed time above 217°C : 60~90 sec.
 Max temperature: 260°C .
 Max time at max temperature: 10 sec.
 Allowed Reflow time: 2x max.

Packaging Information:

Tape Dimension :

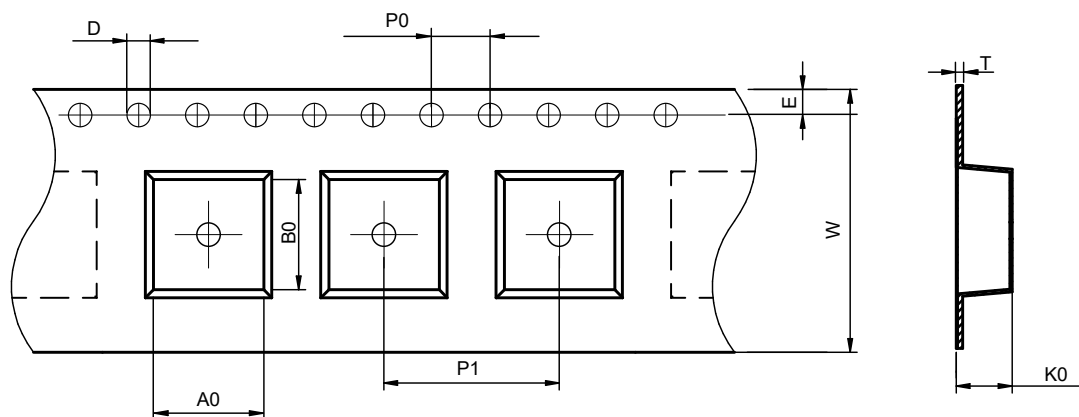

| Series | A0 (mm) | B0 (mm) | D (mm) | P0 (mm) | P1 (mm) | W (mm) | K0 (mm) | E (mm) | T (mm) |
|---------|---------|---------|---------|---------|----------|----------|---------|----------|-----------|
| MDA7030 | 7.0±0.1 | 7.7±0.1 | 1.5±0.1 | 4.0±0.1 | 12.0±0.1 | 16.0±0.3 | 3.4±0.1 | 1.75±0.1 | 0.35±0.05 |

Peel force of top cover tape:

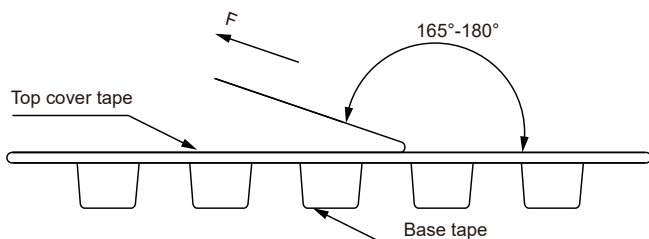

The peel force of top cover tape shall be between 0.1 to 1.3 N

Product Marking:

| | |
|---------|--------------------------------|
| Marking | K+Printing (Inductance+period) |
|---------|--------------------------------|

Reel Dimension: [mm]

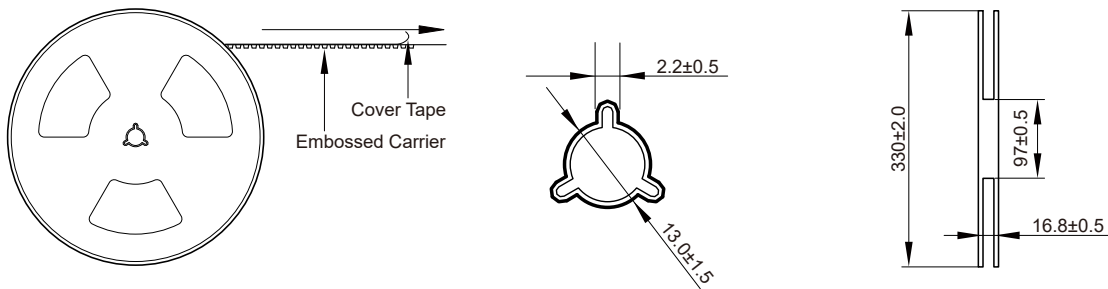

Packaging Quantity:

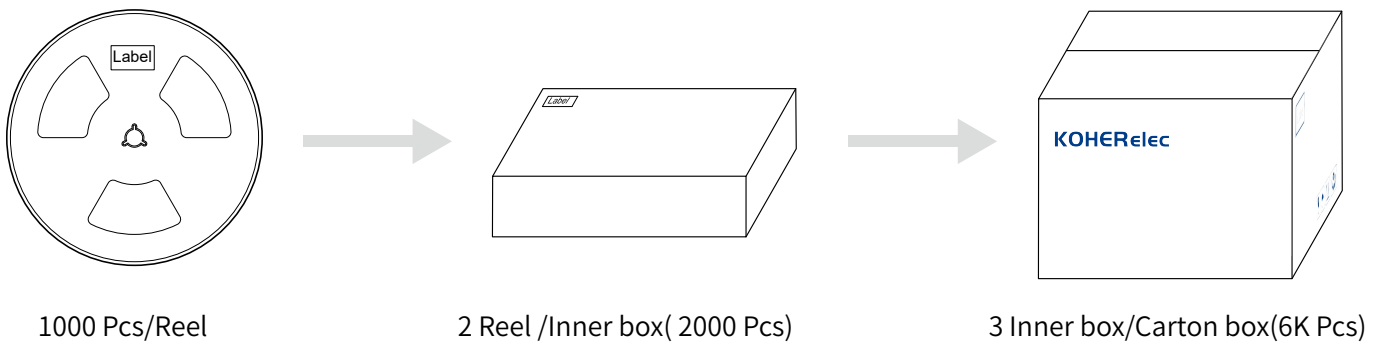

Cautions and Warnings:

Storage Conditions :

- The storage period is within 12 months after the completion of production. Be sure to follow the storage conditions (temperature: -5 to 35°C, humidity: 75% RH Max).If the storage period elapses, the soldering of the terminal electrodes may deteriorate.The warranty period is one year.
- Product should not be exposed to environment with high temperature, high humidity, dust, corrosive gas and etc.
- Products should be handled with care to avoid damage or contamination from perspiration and skin oils.
- Please always handle products carefully to prevent any damage caused by dropping down or inappropriate removing.

Operation Instructions:

- Self heating (temperature increase) occurs when the power is turned ON, so the tolerance should be sufficient for the set thermal design.
- Before soldering, be sure to preheat components.The preheating temperature should be set so that the temperature difference between the solder temperature and chip temperature does not exceed 150°C.
- Soldering corrections after mounting should be within the range of the conditions determined in the specifications.If overheated, a short circuit, performance deterioration, or lifespan shortening may occur.
- Generally, Koher might not be familiar with either customer's specific application or actual requests as customer does.As a result customer shall be responsible for checking and confirming whether Koher product with the performance described in the product specification is suitable for using in customer's particular application or not.

Looking for pricing, stock, or lifecycle information?

Click below to explore more details on WIN SOURCE:

- ⊖ [View MDA7030-2R2M on WIN SOURCE](#)
- ⊖ [KOHERShanghaiElectronics Co.,Ltd Information](#)

Optimize Your Supply Chain with WIN SOURCE Solutions

- ✓ Global Sourcing Solution
- ✓ Obsolete Management
- ✓ Cost Control Management
- ✓ Shortage Management
- ✓ Alternative Solution
- ✓ Excess Inventory Management