



**THE DATASHEET OF  
BCMA9070-152Y**



# BCMA Series

## Common Mode Filters For Automotive Power Line

### Size 9070



#### FEATURES

- Exclusive square type closed magnetic core designed as an exclusive core is used, so it can be small while maintaining the same features.
- Low profile design makes it optimal for surface mounting.
- Excellent impedance characteristics, making it great for suppressing common mode noise.
- Operating temperature range: -40 to +125°C
- AEC-Q200 qualified
- Quantity: 800pcs

#### APPLICATIONS

- Measures against common mode noise in power lines for various DC power lines, multimedia devices, and various electronic devices

#### Dimensions: [mm]

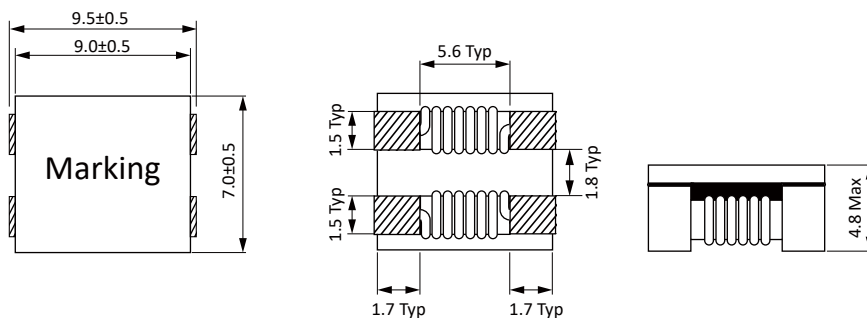

#### Land Pattern: [mm]

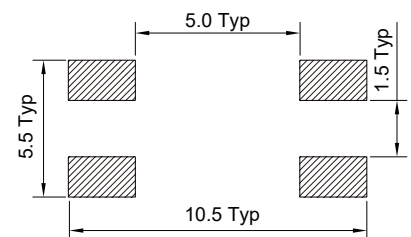

#### Electrical Properties:

Part No	Impedance Min. (Ω)	Impedance Typ. (Ω)	Test Frequency @0.1V	I <sub>R</sub> Max. (A)	R <sub>DC</sub> Max. (mΩ)	V <sub>DC</sub> Max. (Volts)	IR Min. (MΩ)
BCMA9070-301Y	225	300	100MHz	6.0	6	80	10
BCMA9070-501Y	450	500	100MHz	5.5	8	80	10
BCMA9070-701Y	500	700	100MHz	5.0	10	80	10
BCMA9070-102Y	750	1000	100MHz	4.0	13	80	10
BCMA9070-152Y	1000	1500	100MHz	4.5	15	80	10
BCMA9070-222Y	1700	2200	20~50MHz	3.0	50	80	10
BCMA9070-272Y	2000	2700	20~50MHz	3.5	32	80	10
BCMA9070-302Y	2500	3000	20~50MHz	1.9	85	80	10
BCMA9070-402Y	3300	4000	20~50MHz	1.8	100	80	10

Temperature Rise Current: The actual value of DC current when the temperature rise is  $\Delta T=40^{\circ}\text{C}$

Typical Electrical Characteristics:

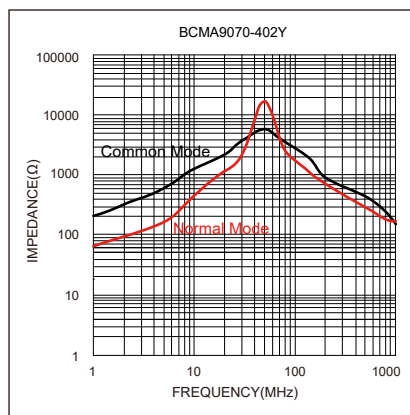
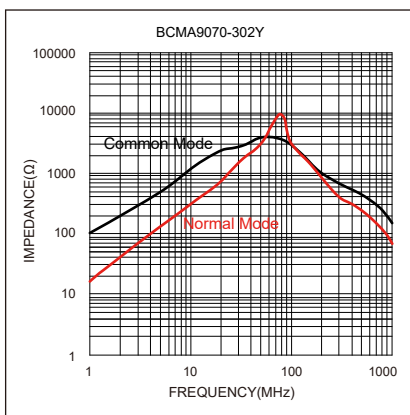
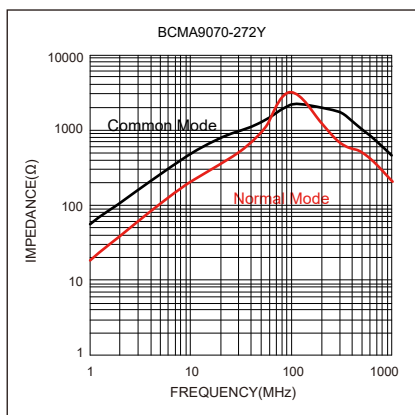
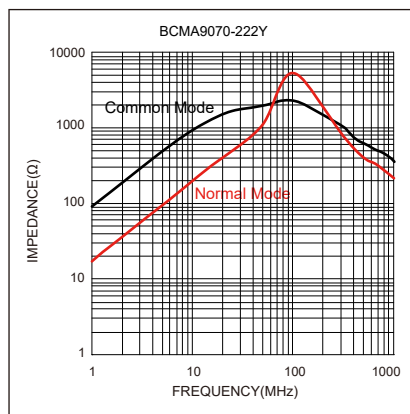
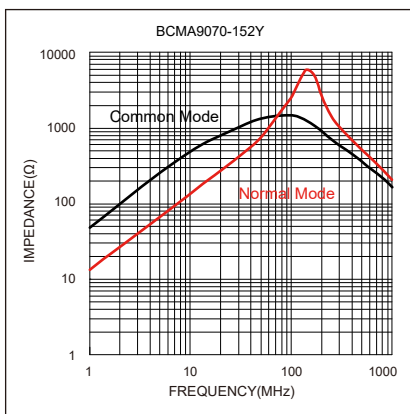
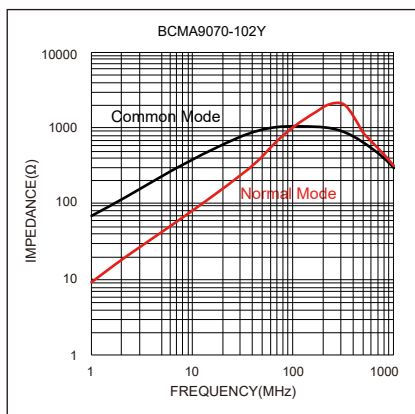
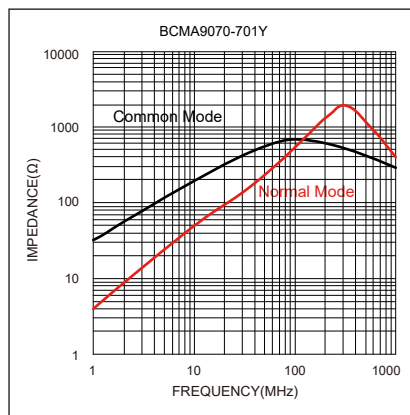
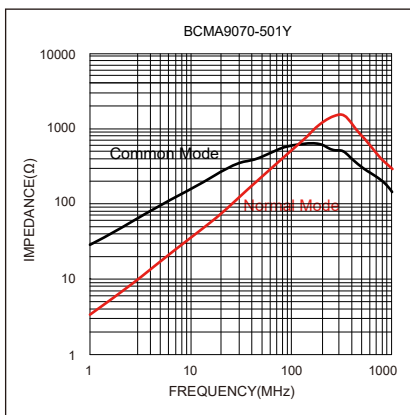
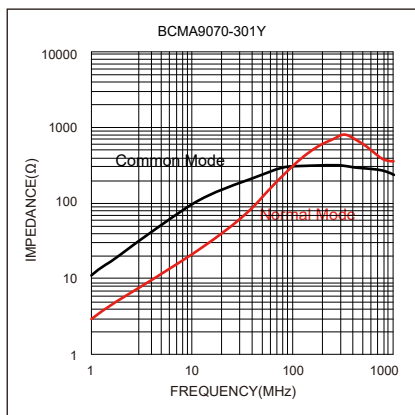

Soldering Reflow:

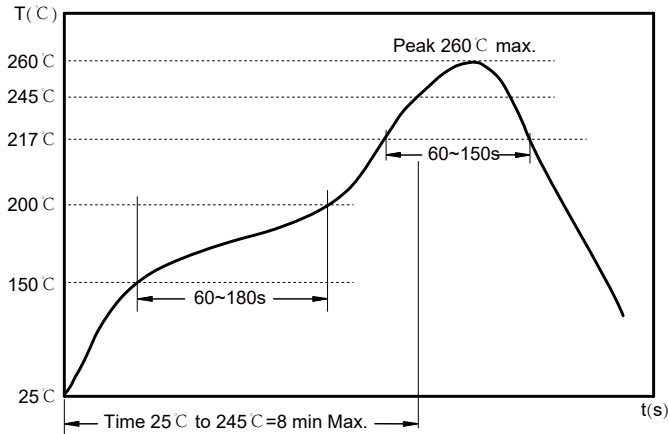

Preheat condition: 150 ~200 C / 60~180 sec.  
 Allowed time above 217 C: 60~150 sec.  
 Max temperature: 260 C.  
 Max time at max temperature: 10 sec.  
 Allowed Reflow time: 3x max.

Packaging Information:

Tape Dimension:

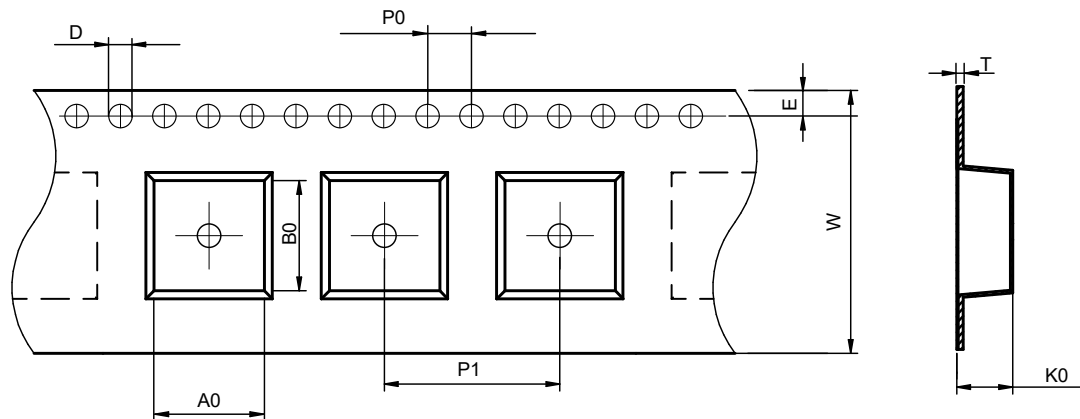

Series	A0 (mm)	B0 (mm)	D (mm)	P0 (mm)	P1 (mm)	W (mm)	K0 (mm)	E (mm)	T (mm)
BCMA9070	7.6±0.1	9.60±0.1	1.5±0.1	4.0±0.1	16.0±0.1	24.0±0.3	5.10±0.1	1.75±0.1	0.35±0.05

Product Marking:

Marking	Printing (Impedance)
---------	----------------------

Peel force of top cover tape:

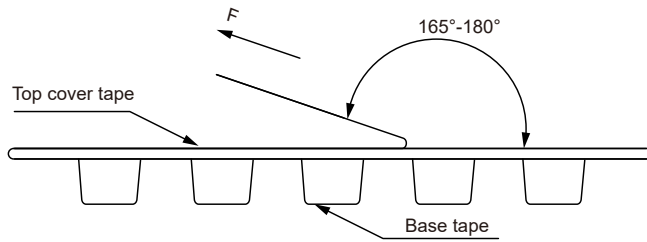

The peel force of top cover tape shall be between 0.10 to 1.17 N

Reel Dimension: [mm]

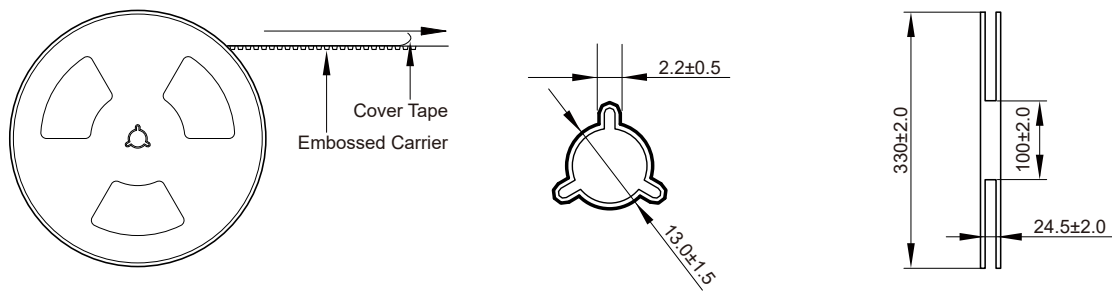

Packaging Quantity:

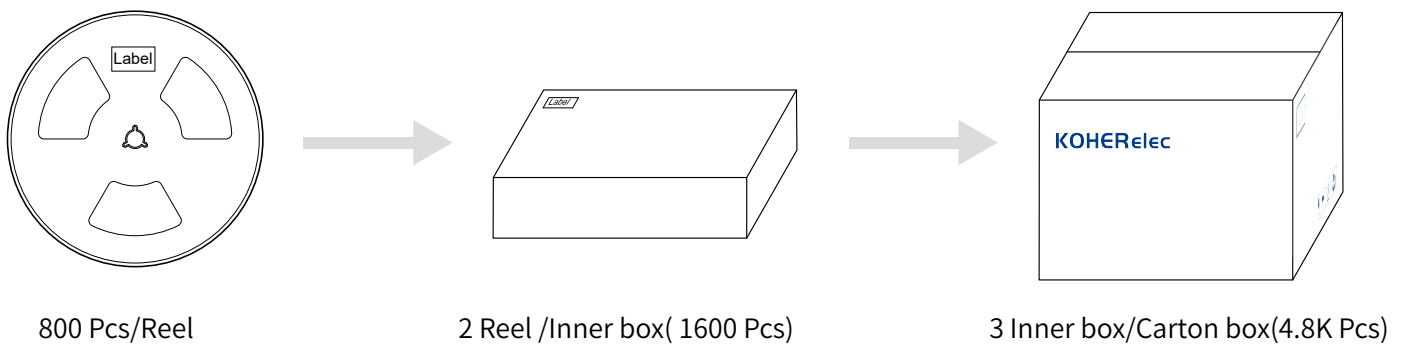

## Cautions and Warnings:

### Storage Conditions:

- The storage period is within 12 months after the completion of production. Be sure to follow the storage conditions (temperature: -5 to 35°C, humidity: 75% RH Max). If the storage period elapses, the soldering of the terminal electrodes may deteriorate. The warranty period is one year.
- Product should not be exposed to environment with high temperature, high humidity, dust, corrosive gas and etc.
- Products should be handled with care to avoid damage or contamination from perspiration and skin oils.
- Please always handle products carefully to prevent any damage caused by dropping down or inappropriate removing.

### Operation Instructions:

- Self heating (temperature increase) occurs when the power is turned ON, so the tolerance should be sufficient for the set thermal design.
- Before soldering, be sure to preheat components. The preheating temperature should be set so that the temperature difference between the solder temperature and chip temperature does not exceed 150°C.
- Soldering corrections after mounting should be within the range of the conditions determined in the specifications. If overheated, a short circuit, performance deterioration, or lifespan shortening may occur.
- Generally, Koher might not be familiar with either customer's specific application or actual requests as customer does. As a result customer shall be responsible for checking and confirming whether Koher product with the performance described in the product specification is suitable for using in customer's particular application or not.

### Conformal coating:

- The inductance value may change due to the high cure stress of the resin used for coating or molding.
- An open circuit may occur due to mechanical stress from the resin, its amount, cured shape, or operating conditions.
- Please exercise careful attention when selecting a resin for the coating or molding process.
- Prior to using the coating resin, please verify that no reliability issues are observed.
- When applying conformal coating for product protection, materials with a high shrinkage rate should be avoided. If such materials must be used, it is recommended to apply silicone around the inductor core in a closed loop to prevent the conformal coating from flowing into or penetrating the windings, thereby avoiding open-circuit failures caused by the coating's thermal stress.

## Looking for pricing, stock, or lifecycle information?

Click below to explore more details on WIN SOURCE:

- ⊖ [View BCMA9070-152Y on WIN SOURCE](#)
- ⊖ [KOHERShanghaiElectronics Co.,Ltd Information](#)

## Optimize Your Supply Chain with WIN SOURCE Solutions

- ✓ Global Sourcing Solution
- ✓ Obsolete Management
- ✓ Cost Control Management
- ✓ Shortage Management
- ✓ Alternative Solution
- ✓ Excess Inventory Management