



**THE DATASHEET OF
BCMA9070-301Y**



BCMA Series

Common Mode Filters For Automotive Power Line

Size 9070



FEATURES

- Exclusive square type closed magnetic core designed as an exclusive core is used, so it can be small while maintaining the same features.
- Low profile design makes it optimal for surface mounting.
- Excellent impedance characteristics, making it great for suppressing common mode noise.
- Operating temperature range: -40 to $+125^{\circ}\text{C}$
- AEC-Q200 qualified
- Quantity: 800pcs

APPLICATIONS

- Measures against common mode noise in power lines for various DC power lines, multimedia devices, and various electronic devices

Dimensions: [mm]

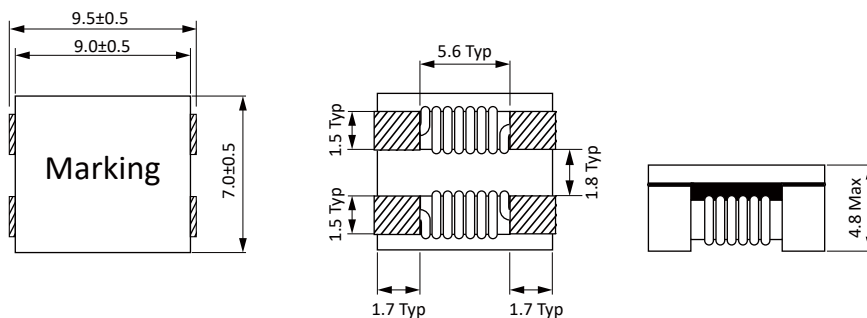

Land Pattern: [mm]

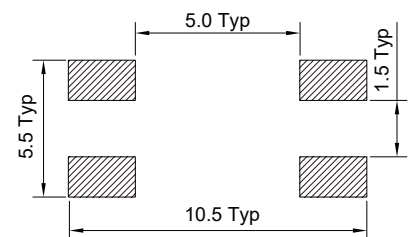

Electrical Properties:

Part No	Impedance Min. (Ω)	Impedance Typ. (Ω)	Test Frequency @0.1V	I_R Max. (A)	R_{DC} Max. (m Ω)	V_{DC} Max. (Volts)	IR Min. (M Ω)
BCMA9070-301Y	225	300	100MHz	6.0	6	80	10
BCMA9070-501Y	450	500	100MHz	5.5	8	80	10
BCMA9070-701Y	500	700	100MHz	5.0	10	80	10
BCMA9070-102Y	750	1000	100MHz	4.0	13	80	10
BCMA9070-152Y	1000	1500	100MHz	4.5	15	80	10
BCMA9070-222Y	1700	2200	20~50MHz	3.0	50	80	10
BCMA9070-272Y	2000	2700	20~50MHz	3.5	32	80	10
BCMA9070-302Y	2500	3000	20~50MHz	1.9	85	80	10
BCMA9070-402Y	3300	4000	20~50MHz	1.8	100	80	10

Temperature Rise Current: The actual value of DC current when the temperature rise is $\Delta T=40^{\circ}\text{C}$

Typical Electrical Characteristics:

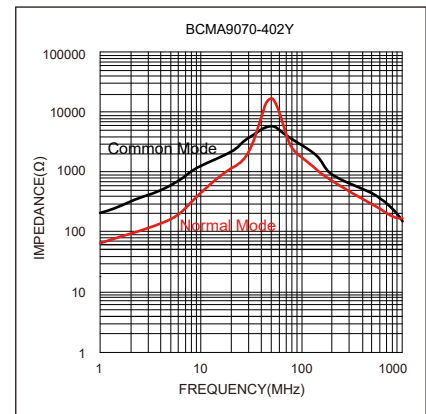
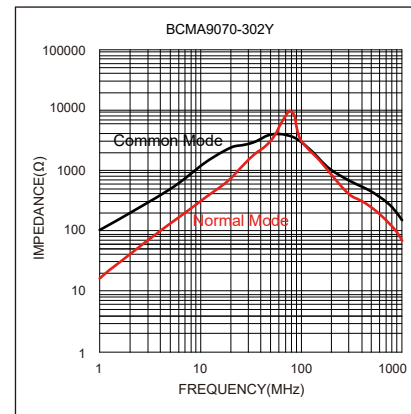
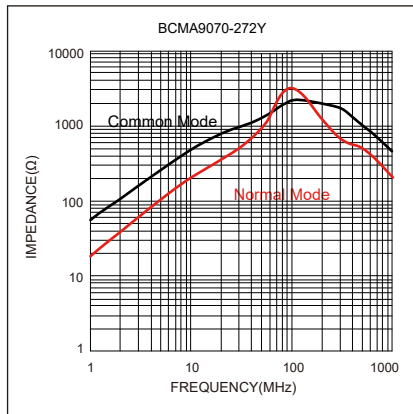
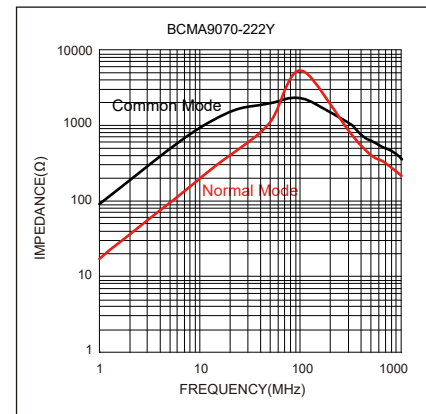
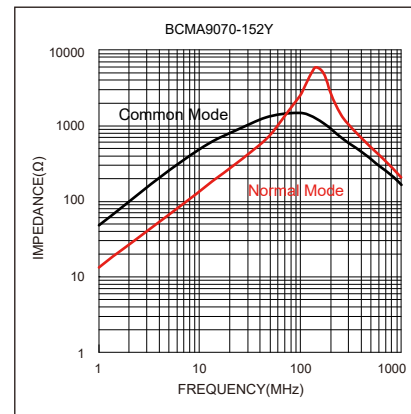
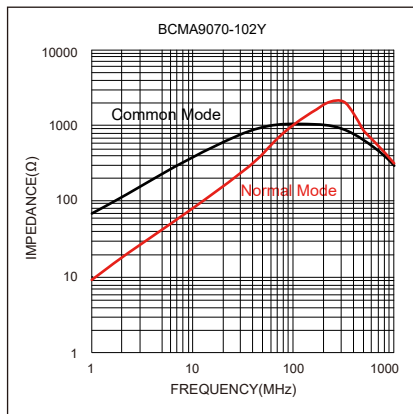
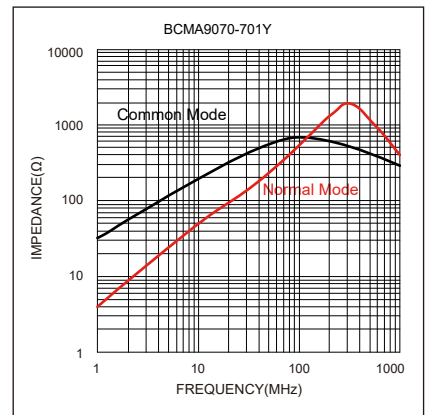
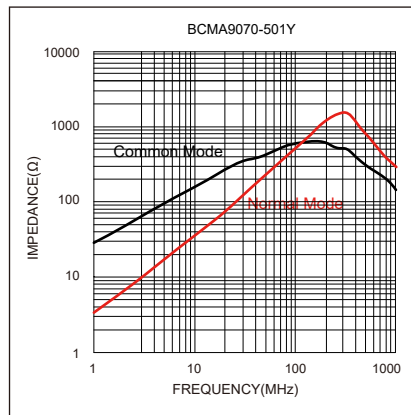
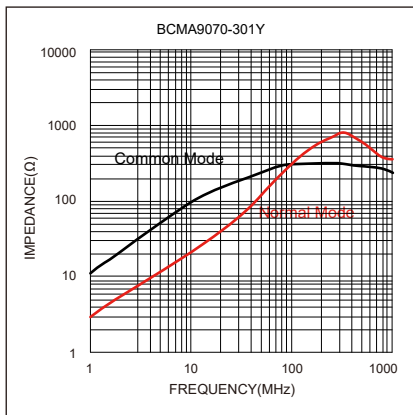

Soldering Reflow:

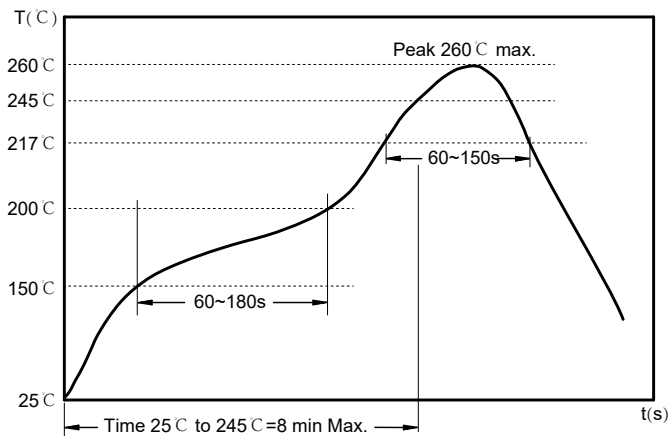

Preheat condition: 150 ~200 °C / 60~180 sec.
 Allowed time above 217 °C: 60~150 sec.
 Max temperature: 260 °C .
 Max time at max temperature: 10 sec.
 Allowed Reflow time: 3x max.

Packaging Information:

Tape Dimension :

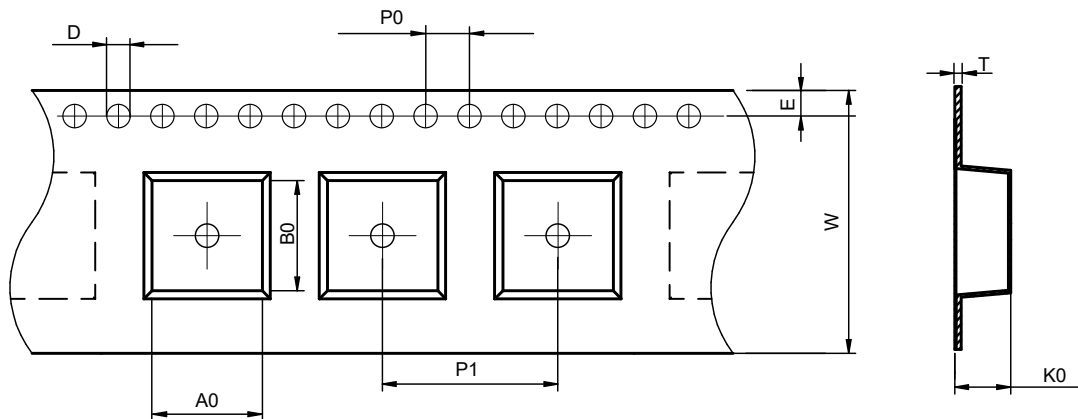

Series	A0 (mm)	B0 (mm)	D (mm)	P0 (mm)	P1 (mm)	W (mm)	K0 (mm)	E (mm)	T (mm)
BCMA9070	7.6±0.1	9.60±0.1	1.5±0.1	4.0±0.1	16.0±0.1	24.0±0.3	5.10±0.1	1.75±0.1	0.35±0.05

Peel force of top cover tape:

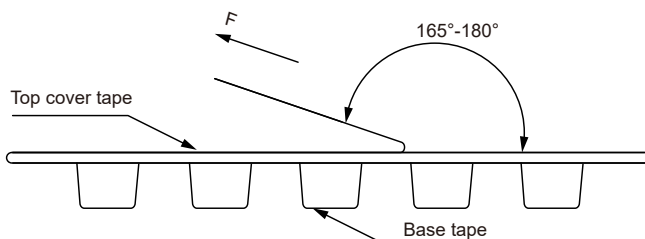

The peel force of top cover tape shall be between 0.10 to 1.17 N

Product Marking:

Marking	Printing (Impedance)
---------	----------------------

Reel Dimension: [mm]

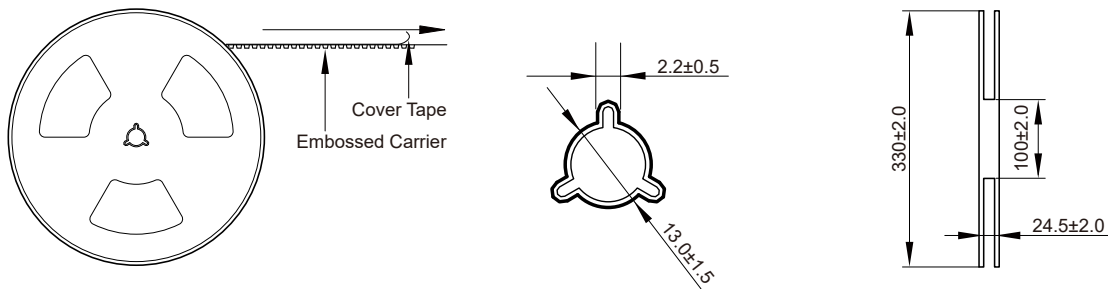

Packaging Quantity:

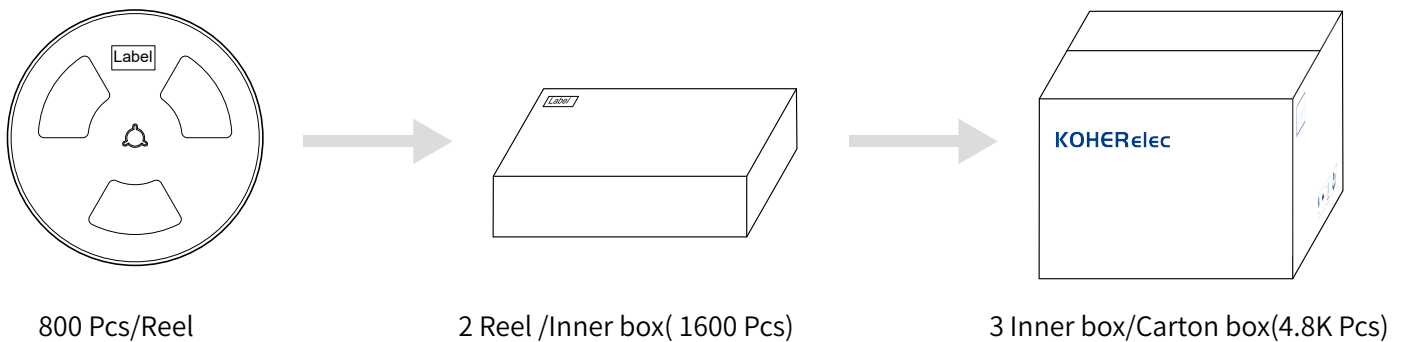

Cautions and Warnings:

Storage Conditions:

- The storage period is within 12 months after the completion of production. Be sure to follow the storage conditions (temperature: -5 to 35°C, humidity: 75% RH Max).If the storage period elapses, the soldering of the terminal electrodes may deteriorate.The warranty period is one year.
- Product should not be exposed to environment with high temperature, high humidity, dust, corrosive gas and etc.
- Products should be handled with care to avoid damage or contamination from perspiration and skin oils.
- Please always handle products carefully to prevent any damage caused by dropping down or inappropriate removing.

Operation Instructions:

- Self heating (temperature increase) occurs when the power is turned ON, so the tolerance should be sufficient for the set thermal design.
- Before soldering, be sure to preheat components.The preheating temperature should be set so that the temperature difference between the solder temperature and chip temperature does not exceed 150°C.
- Soldering corrections after mounting should be within the range of the conditions determined in the specifications.If overheated, a short circuit, performance deterioration, or lifespan shortening may occur.
- Generally, Koher might not be familiar with either customer's specific application or actual requests as customer does.As a result customer shall be responsible for checking and confirming whether Koher product with the performance described in the product specification is suitable for using in customer's particular application or not.

Looking for pricing, stock, or lifecycle information?

Click below to explore more details on WIN SOURCE:

- ⊖ [View BCMA9070-301Y on WIN SOURCE](#)
- ⊖ [KOHERShanghaiElectronics Co.,Ltd Information](#)

Optimize Your Supply Chain with WIN SOURCE Solutions

- ✓ Global Sourcing Solution
- ✓ Obsolete Management
- ✓ Cost Control Management
- ✓ Shortage Management
- ✓ Alternative Solution
- ✓ Excess Inventory Management