



**THE DATASHEET OF  
HSMP-3892-TR1G**



# HSMP-389x Series, HSMP-489x Series

## Surface Mount RF PIN Switch Diodes



## Data Sheet



### Description/Applications

The HSMP-389x series is optimized for switching applications where low resistance at low current and low capacitance are required. The HSMP-489x series products feature ultra low parasitic inductance. These products are specifically designed for use at frequencies which are much higher than the upper limit for conventional PIN diodes.

### Pin Connections and Package Marking

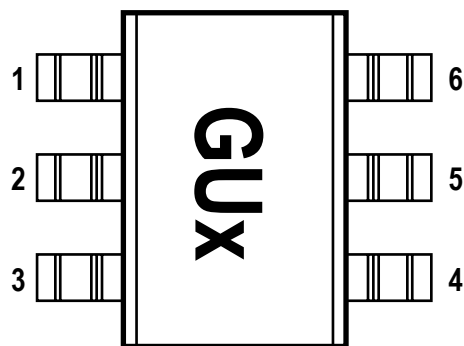

#### Notes:

1. Package marking provides orientation, identification, and date code.
2. See "Electrical Specifications" for appropriate package marking.

### Features

- Unique Configurations in Surface Mount Packages
  - Add Flexibility
  - Save Board Space
  - Reduce Cost
- Switching
  - Low Capacitance
  - Low Resistance at Low Current
- Low Failure in Time (FIT) Rate<sup>[1]</sup>
- Matched Diodes for Consistent Performance
- Better Thermal Conductivity for Higher Power Dissipation
- Lead-free

#### Note:

1. For more information see the Surface Mount PIN Reliability Data Sheet.

**Package Lead Code Identification,  
SOT-23/143  
(Top View)**

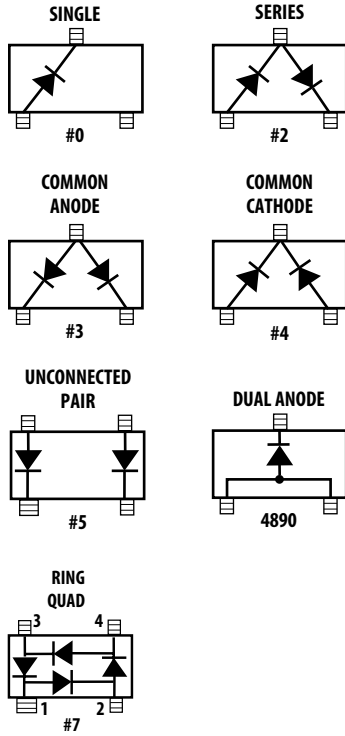

UNDER DEVELOPMENT

**Package Lead Code Identification,  
SOT-323  
(Top View)**

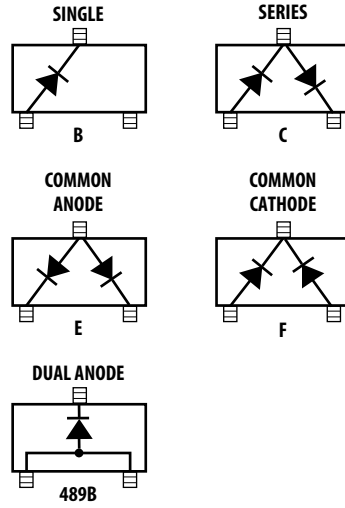

**Package Lead Code Identification,  
SOT-363  
(Top View)**



**Absolute Maximum Ratings<sup>[1]</sup> T<sub>c</sub> = +25°C**

Symbol	Parameter	Unit	SOT-23/143	SOT-323/363
I <sub>f</sub>	Forward Current (1 μs Pulse)	Amp	1	1
P <sub>IV</sub>	Peak Inverse Voltage	V	100	100
T <sub>j</sub>	Junction Temperature	°C	150	150
T <sub>stg</sub>	Storage Temperature	°C	-65 to 150	-65 to 150
θ <sub>jc</sub>	Thermal Resistance <sup>[2]</sup>	°C/W	500	150

**Notes:**

1. Operation in excess of any one of these conditions may result in permanent damage to the device.
2. T<sub>c</sub> = +25°C, where T<sub>c</sub> is defined to be the temperature at the package pins where contact is made to the circuit board.

**ESD WARNING:**

**Handling Precautions Should Be Taken To Avoid Static Discharge.**

## Electrical Specifications, $T_c = 25^\circ\text{C}$ , each diode

Part Number HSMP-	Package Marking Code	Lead Code	Configuration	Minimum Breakdown Voltage $V_{BR}$ (V)	Maximum Series Resistance $R_s$ ( $\Omega$ )	Maximum Total Capacitance $C_T$ (pF)
3890	G0 <sup>[1]</sup>	0	Single	100	2.5	0.30
3892	G2 <sup>[1]</sup>	2	Series			
3893	G3 <sup>[1]</sup>	3	Common Anode			
3894	G4 <sup>[1]</sup>	4	Common Cathode			
3895	G5 <sup>[1]</sup>	5	Unconnected Pair			
389B	G0 <sup>[2]</sup>	B	Single			
389C	G2 <sup>[2]</sup>	C	Series			
389E	G3 <sup>[2]</sup>	E	Common Anode			
389F	G4 <sup>[2]</sup>	F	Common Cathode			
389L	GL <sup>[2]</sup>	L	Unconnected Trio			
389R	S <sup>[2]</sup>	R	Dual Switch Mode			
389T	Z <sup>[2]</sup>	T	Low Inductance Single			
389U	GU <sup>[2]</sup>	U	Series-Shunt Pair			
389V	GV <sup>[2]</sup>	V	High Frequency Series Pair			
Test Conditions				$V_R = V_{BR}$ Measure $I_R = 10 \mu\text{A}$	$I_F = 5 \text{ mA}$ $f = 100 \text{ MHz}$	$V_R = 5 \text{ V}$ $f = 1 \text{ MHz}$

### Notes:

- Package marking code is white.
- Package is laser marked.

## High Frequency (Low Inductance, 500 MHz – 3 GHz) PIN Diodes

Part Number HSMP-	Package Marking Code <sup>[1]</sup>	Configuration	Minimum Breakdown Voltage $V_{BR}$ (V)	Maximum Series Resistance $R_s$ ( $\Omega$ )	Typical Total Capacitance $C_T$ (pF)	Maximum Total Capacitance $C_T$ (pF)	Typical Total Inductance $L_T$ (nH)
489x	GA	Dual Anode	100	2.5	0.33	0.375	1.0
Test Conditions			$V_R = V_{BR}$ Measure $I_R = 10 \mu\text{A}$	$I_F = 5 \text{ mA}$	$f = 1 \text{ MHz}$ $V_R = 5 \text{ V}$	$V_R = 5 \text{ V}$ $f = 1 \text{ MHz}$	$f = 500 \text{ MHz} - 3 \text{ GHz}$

### Note:

- SOT-23 package marking code is white; SOT-323 is laser marked.

## Typical Parameters at $T_c = 25^\circ\text{C}$

Part Number HSMP-	Series Resistance $R_s$ ( $\Omega$ )	Carrier Lifetime $\tau$ (ns)	Total Capacitance $C_T$ (pF)
389x	3.8	200	0.20 @ 5V
Test Conditions	$I_F = 1 \text{ mA}$ $f = 100 \text{ MHz}$	$I_F = 10 \text{ mA}$ $I_R = 6 \text{ mA}$	

HSMF-389x Series Typical Performance,  $T_c = 25^\circ\text{C}$ , each diode



Figure 1. Total RF Resistance at 25 C vs. Forward Bias Current.



Figure 2. Capacitance vs. Reverse Voltage.



Figure 3. 2nd Harmonic Input Intercept Point vs. Forward Bias Current.



Figure 4. Typical Reverse Recovery Time vs. Reverse Voltage.



Figure 5. Forward Current vs. Forward Voltage.

Typical Applications for Multiple Diode Products



Figure 6. HSMF-389L used in a SP3T Switch.



Figure 7. HSMF-389L Unconnected Trio used in a Dual Voltage, High Isolation Switch.

Typical Applications for Multiple Diode Products (continued)



Figure 8. HSMP-389L Unconnected Trio used in a Positive Voltage, High Isolation Switch.



Figure 9. HSMP-389T used in a Low Inductance Shunt Mounted Switch.

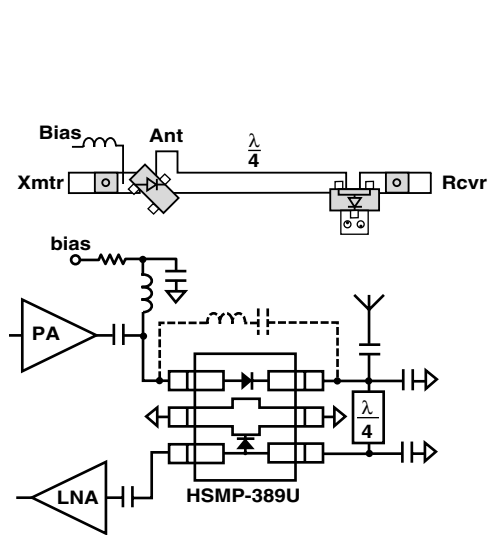

Figure 10. HSMP-389U Series/Shunt Pair used in a 900 MHz Transmit/Receive Switch.

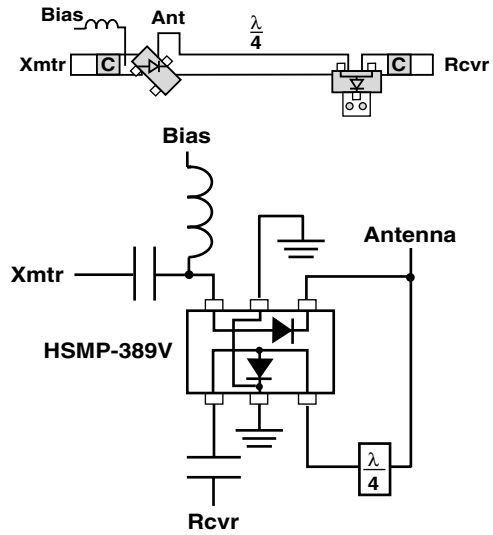

Figure 11. HSMP-389V Series/Shunt Pair used in a 1.8 GHz Transmit/Receive Switch.

Typical Applications for Multiple Diode Products (continued)



Figure 12. Simple SPDT Switch, Using Only Positive Current.



Figure 13. High Isolation SPDT Switch, Dual Bias.



Figure 14. Switch Using Both Positive and Negative Bias Current.



Figure 15. Very High Isolation SPDT Switch, Dual Bias.

## Typical Applications for HSMP-489x Low Inductance Series

### Microstrip Series Connection for HSMP-489x Series

In order to take full advantage of the low inductance of the HSMP-489x series when using them in series applications, both lead 1 and lead 2 should be connected together, as shown in Figure 17.

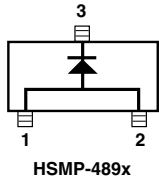

Figure 16. Internal Connections.



Figure 17. Circuit Layout.

### Microstrip Shunt Connections for HSMP-489x Series

In Figure 18, the center conductor of the microstrip line is interrupted and leads 1 and 2 of the HSMP-489x diode are placed across the resulting gap. This forces the 1.5 nH lead inductance of leads 1 and 2 to appear as part of a low pass filter, reducing the shunt parasitic inductance and increasing the maximum available attenuation. The 0.3 nH of shunt inductance external to the diode is created by the via holes, and is a good estimate for 0.032" thick material.



Figure 18. Circuit Layout.



Figure 19. Equivalent Circuit.

## Equivalent Circuit Model

### HSMP-389x Chip\*

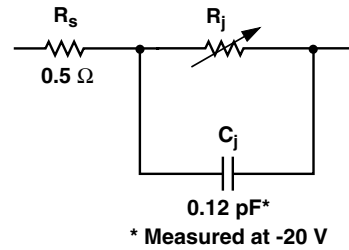

$$R_T = 0.5 + R_j$$

$$C_T = C_P + C_j$$

$$R_j = \frac{20}{I^{0.9}} \Omega$$

I = Forward Bias Current in mA

\* See AN1124 for package models

### Co-Planar Waveguide Shunt Connection for HSMP-489x Series

Co-Planar waveguide, with ground on the top side of the printed circuit board, is shown in Figure 20. Since it eliminates the need for via holes to ground, it offers lower shunt parasitic inductance and higher maximum attenuation when compared to a microstrip circuit.

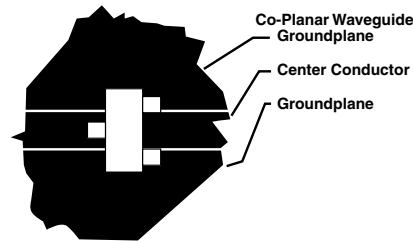

Figure 20. Circuit Layout.



Figure 21. Equivalent Circuit.

A SPICE model is not available for PIN diodes as SPICE does not provide for a key PIN diode characteristic, carrier lifetime.

## Assembly Information



Figure 22. PCB Pad Layout, SOT-363.  
(dimensions in inches).



Figure 23. PCB Pad Layout, SOT-323.  
(dimensions in inches).



Figure 24. PCB Pad Layout, SOT-23.



Figure 25. PCB Pad Layout, SOT-143.

## SMT Assembly

Reliable assembly of surface mount components is a complex process that involves many material, process, and equipment factors, including: method of heating (e.g., IR or vapor phase reflow, wave soldering, etc.) circuit board material, conductor thickness and pattern, type of solder alloy, and the thermal conductivity and thermal mass of components. Components with a low mass, such as the SOT package, will reach solder reflow temperatures faster than those with a greater mass.

Avago Technologies' diodes have been qualified to the time-temperature profile shown in Figure 26. This profile is representative of an IR reflow type of surface mount assembly process.

After ramping up from room temperature, the circuit board with components attached to it (held in place with solder paste) passes through one or more preheat

zones. The preheat zones increase the temperature of the board and components to prevent thermal shock and begin evaporating solvents from the solder paste. The reflow zone briefly elevates the temperature sufficiently to produce a reflow of the solder.

The rates of change of temperature for the ramp-up and cool-down zones are chosen to be low enough to not cause deformation of the board or damage to components due to thermal shock. The maximum temperature in the reflow zone ( $T_{MAX}$ ) should not exceed 260°C.

These parameters are typical for a surface mount assembly process for Avago Technologies diodes. As a general guideline, the circuit board and components should be exposed only to the minimum temperatures and times necessary to achieve a uniform reflow of solder.



Figure 26. Surface Mount Assembly Profile.

### Lead-Free Reflow Profile Recommendation (IPC/JEDEC J-STD-020C)

Reflow Parameter	Lead-Free Assembly	
Average ramp-up rate (Liquidus Temperature ( $T_{S(max)}$ ) to Peak)	3°C/ second max	
Preheat	Temperature Min ( $T_{S(min)}$ )	150°C
	Temperature Max ( $T_{S(max)}$ )	200°C
	Time (min to max) ( $t_s$ )	60-180 seconds
Ts(max) to TL Ramp-up Rate	3°C/second max	
Time maintained above:	Temperature ( $T_L$ )	217°C
	Time ( $t_L$ )	60-150 seconds
Peak Temperature ( $T_p$ )	260 +0/-5°C	
Time within 5 °C of actual Peak temperature ( $t_p$ )	20-40 seconds	
Ramp-down Rate	6°C/second max	
Time 25 °C to Peak Temperature	8 minutes max	

Note 1: All temperatures refer to topside of the package, measured on the package body surface

# Package Dimensions

## Outline 23 (SOT-23)

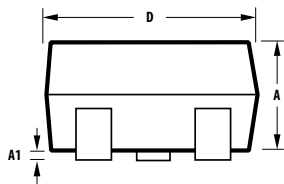
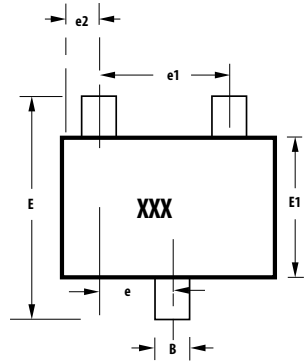

Notes:  
XXX-package marking  
Drawings are not to scale

SYMBOL	DIMENSIONS (mm)	
	MIN.	MAX.
A	0.79	1.20
A1	0.000	0.100
B	0.30	0.54
C	0.08	0.20
D	2.73	3.13
E	1.15	1.50
e	0.89	1.02
e1	1.78	2.04
e2	0.45	0.60
E	2.10	2.70
L	0.45	0.69

## Outline SOT-323 (SC-70 3 Lead)

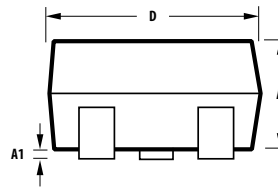
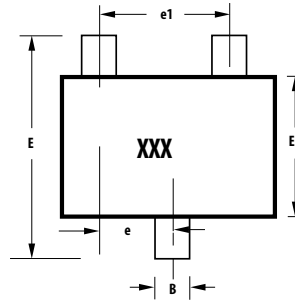

Notes:  
XXX-package marking  
Drawings are not to scale

SYMBOL	DIMENSIONS (mm)	
	MIN.	MAX.
A	0.80	1.00
A1	0.00	0.10
B	0.15	0.40
C	0.08	0.25
D	1.80	2.25
E	1.10	1.40
e	0.65 typical	
e1	1.30 typical	
E	1.80	2.40
L	0.26	0.46

## Outline 143 (SOT-143)

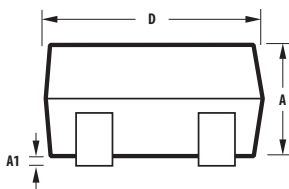
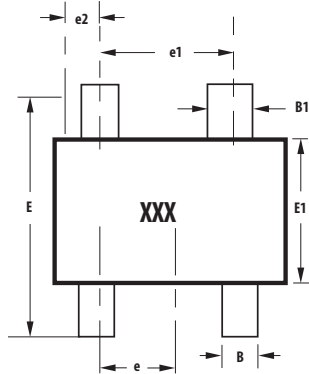

Notes:  
XXX-package marking  
Drawings are not to scale

SYMBOL	DIMENSIONS (mm)	
	MIN.	MAX.
A	0.79	1.097
A1	0.013	0.10
B	0.36	0.54
B1	0.76	0.92
C	0.086	0.152
D	2.80	3.06
E	1.20	1.40
e	0.89	1.02
e1	1.78	2.04
e2	0.45	0.60
E	2.10	2.65
L	0.45	0.69

## Outline SOT-363 (SC-70 6 Lead)

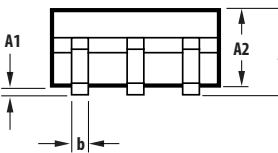
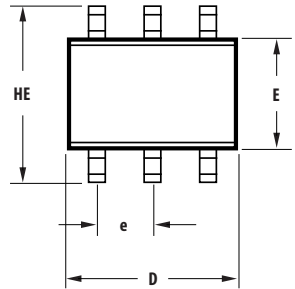

SYMBOL	DIMENSIONS (mm)	
	MIN.	MAX.
E	1.15	1.35
D	1.80	2.25
HE	1.80	2.40
A	0.80	1.10
A2	0.80	1.00
A1	0.00	0.10
e	0.650 BCS	
b	0.15	0.30
c	0.08	0.25
L	0.10	0.46

## Package Characteristics

Lead Material \_\_\_\_\_ Copper (SOT-323/363); Alloy 42 (SOT-23/143)  
 Lead Finish \_\_\_\_\_ Tin 100%  
 Maximum Soldering Temperature \_\_\_\_\_ 260°C for 5 seconds  
 Minimum Lead Strength \_\_\_\_\_ 2 pounds pull  
 Typical Package Inductance \_\_\_\_\_ 2 nH  
 Typical Package Capacitance \_\_\_\_\_ 0.08 pF (opposite leads)

## Ordering Information

Specify part number followed by option. For example:



## Option Descriptions

- BLKG = Bulk, 100 pcs. per antistatic bag
- TR1G = Tape and Reel, 3000 devices per 7" reel
- TR2G = Tape and Reel, 10,000 devices per 13" reel

Tape and Reeling conforms to Electronic Industries RS-481, "Taping of Surface Mounted Components for Automated Placement."

## Device Orientation

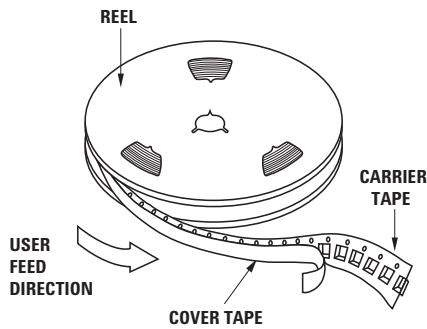

For Outlines SOT-23, -323

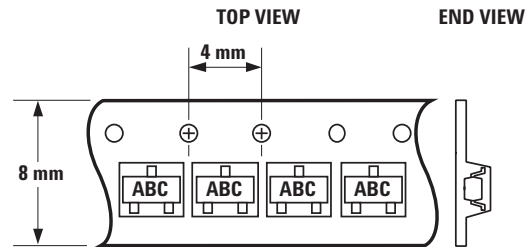

Note: "AB" represents package marking code.  
 "C" represents date code.

For Outline SOT-143



Note: "AB" represents package marking code.  
 "C" represents date code.

For Outline SOT-363

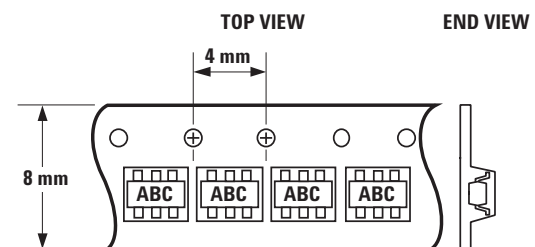

Note: "AB" represents package marking code.  
 "C" represents date code.

# Tape Dimensions and Product Orientation

## For Outline SOT-23



DESCRIPTION		SYMBOL	SIZE (mm)	SIZE (INCHES)
CAVITY	LENGTH	A <sub>0</sub>	3.15 ± 0.10	0.124 ± 0.004
	WIDTH	B <sub>0</sub>	2.77 ± 0.10	0.109 ± 0.004
	DEPTH	K <sub>0</sub>	1.22 ± 0.10	0.048 ± 0.004
	PITCH	P	4.00 ± 0.10	0.157 ± 0.004
	BOTTOM HOLE DIAMETER	D <sub>1</sub>	1.00 + 0.05	0.039 ± 0.002
PERFORATION	DIAMETER	D	1.50 + 0.10	0.059 + 0.004
	PITCH	P <sub>0</sub>	4.00 ± 0.10	0.157 ± 0.004
	POSITION	E	1.75 ± 0.10	0.069 ± 0.004
CARRIER TAPE	WIDTH	W	8.00 + 0.30 - 0.10	0.315 + 0.012 - 0.004
	THICKNESS	t <sub>1</sub>	0.229 ± 0.013	0.009 0.0005
DISTANCE BETWEEN CENTERLINE	CAVITY TO PERFORATION (WIDTH DIRECTION)	F	3.50 ± 0.05	0.138 ± 0.002
	CAVITY TO PERFORATION (LENGTH DIRECTION)	P <sub>2</sub>	2.00 ± 0.05	0.079 ± 0.002

## For Outline SOT-143

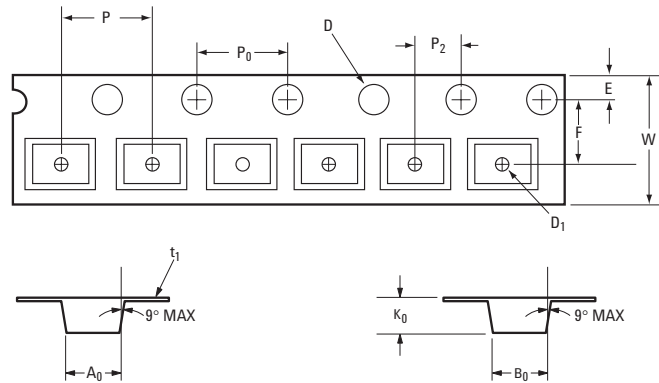

DESCRIPTION		SYMBOL	SIZE (mm)	SIZE (INCHES)
CAVITY	LENGTH	A <sub>0</sub>	3.19 ± 0.10	0.126 ± 0.004
	WIDTH	B <sub>0</sub>	2.80 ± 0.10	0.110 ± 0.004
	DEPTH	K <sub>0</sub>	1.31 ± 0.10	0.052 ± 0.004
	PITCH	P	4.00 ± 0.10	0.157 ± 0.004
	BOTTOM HOLE DIAMETER	D <sub>1</sub>	1.00 + 0.25	0.039 + 0.010
PERFORATION	DIAMETER	D	1.50 + 0.10	0.059 + 0.004
	PITCH	P <sub>0</sub>	4.00 ± 0.10	0.157 ± 0.004
	POSITION	E	1.75 ± 0.10	0.069 ± 0.004
CARRIER TAPE	WIDTH	W	8.00 + 0.30 - 0.10	0.315 + 0.012 - 0.004
	THICKNESS	t <sub>1</sub>	0.254 ± 0.013	0.0100 0.0005
DISTANCE	CAVITY TO PERFORATION (WIDTH DIRECTION)	F	3.50 ± 0.05	0.138 ± 0.002
	CAVITY TO PERFORATION (LENGTH DIRECTION)	P <sub>2</sub>	2.00 ± 0.05	0.079 ± 0.002

# Tape Dimensions and Product Orientation

## For Outlines SOT-323, -363

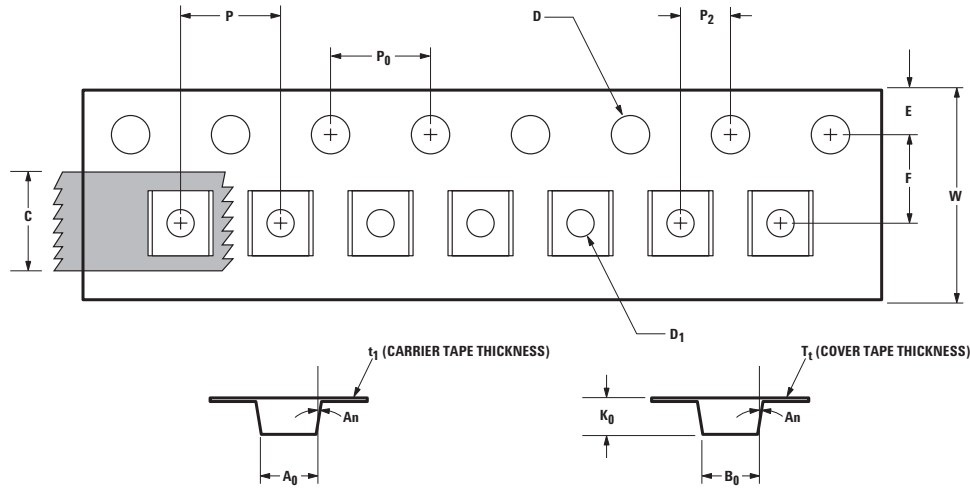

DESCRIPTION		SYMBOL	SIZE (mm)	SIZE (INCHES)
CAVITY	LENGTH	$A_0$	$2.40 \pm 0.10$	$0.094 \pm 0.004$
	WIDTH	$B_0$	$2.40 \pm 0.10$	$0.094 \pm 0.004$
	DEPTH	$K_0$	$1.20 \pm 0.10$	$0.047 \pm 0.004$
	PITCH	$P$	$4.00 \pm 0.10$	$0.157 \pm 0.004$
	BOTTOM HOLE DIAMETER	$D_1$	$1.00 \pm 0.25$	$0.039 \pm 0.010$
PERFORATION	DIAMETER	$D$	$1.55 \pm 0.05$	$0.061 \pm 0.002$
	PITCH	$P_0$	$4.00 \pm 0.10$	$0.157 \pm 0.004$
	POSITION	$E$	$1.75 \pm 0.10$	$0.069 \pm 0.004$
CARRIER TAPE	WIDTH	$W$	$8.00 \pm 0.30$	$0.315 \pm 0.012$
	THICKNESS	$t_1$	$0.254 \pm 0.02$	$0.0100 \pm 0.0008$
COVER TAPE	WIDTH	$C$	$5.4 \pm 0.10$	$0.205 \pm 0.004$
	TAPE THICKNESS	$T_t$	$0.062 \pm 0.001$	$0.0025 \pm 0.00004$
DISTANCE	CAVITY TO PERFORATION (WIDTH DIRECTION)	$F$	$3.50 \pm 0.05$	$0.138 \pm 0.002$
	CAVITY TO PERFORATION (LENGTH DIRECTION)	$P_2$	$2.00 \pm 0.05$	$0.079 \pm 0.002$
ANGLE	FOR SOT-323 (SC70-3 LEAD)	$A_n$	8°C MAX	
	FOR SOT-363 (SC70-6 LEAD)		10°C MAX	

For product information and a complete list of distributors, please go to our web site: [www.avagotech.com](http://www.avagotech.com)

Avago, Avago Technologies, and the A logo are trademarks of Avago Technologies in the United States and other countries. Data subject to change. Copyright © 2005-2009 Avago Technologies. All rights reserved. Obsoletes 5989-0486EN AV02-0813EN - June 2, 2009



## Looking for pricing, stock, or lifecycle information?

Click below to explore more details on WIN SOURCE:

 [View HSMP-3892-TR1G on WIN SOURCE](#)

 [Broadcom Limited](#) Information

## Optimize Your Supply Chain with WIN SOURCE Solutions

-  Global Sourcing Solution
-  Obsolete Management
-  Cost Control Management
-  Shortage Management
-  Alternative Solution
-  Excess Inventory Management