



**THE DATASHEET OF
HPL0603-1N8**



1. Scope

This specification applies to 0.60×0.30mm, fixed thin film chip inductor, rectangular type.

2. Type Designation

HPL 0603 - ※※※
 (1) (2) (3)

(1) Product Type

HPL : fixed thin film chip inductor

(2) Size

0603 : 0.60×0.30mm

(3) The nominal inductance value

Refer to paragraph 4.1 (1).

Refer to paragraph 4.1 (1).

E-12 series Three digits of number

Example 1.0nH=1N0

10nH=10N

(4) A direction mark shall be applied to the protection coating.

3. Physical Dimensions

See Fig.1.

4. Ratings

4.1. Nominal Inductance Value and Tolerance

(1) Nominal Inductance Value : 1nH ~ 6.8nH E-12 series

(2) Tolerance : Refer to Table. 1

4.2. Rated Temperature

(1) Operating Temperature Range : -40 ~ +125 °C

(2) Storage Temperature Range : -40 ~ +125 °C

		/ /			APPD <i>H. Mori</i>	SUSUMU CO.,LTD
		/ /			<i>24 Aug 2002</i>	TITLE: HPL0603-※※※
		/ /			CHKD <i>G. Cho</i>	TEMPORARY SPECIFICATION
		/ /			<i>22 / Aug 2002</i>	
		/ /			DRAWN <i>I. Nakajima</i>	SPEC.NO:
		/ /			22/Aug/2002	HL09-4004-E0
0	First edition.	/ /				
REV	CHANG.NO	NOTE.	DATE	DRAWN	APPD	

Table. 1: Electric Characteristics

Inductance (nH)	Tolerance	Q min.	L, Qmeas Frequency (MHz)	Self Resonance Frequency (MHz)min.	DC (Ω)max.	Rated Current (mA)
1.0	± 0.2 nH	15	300	10000	0.24	510
1.2	± 0.2 nH	15	300	10000	0.30	460
1.5	± 0.2 nH	15	300	10000	0.26	490
1.8	± 0.2 nH	15	300	10000	0.36	420
2.2	± 0.2 nH	15	300	10000	0.50	350
2.7	± 0.2 nH	13	300	10000	0.54	340
3.3	± 0.2 nH	13	300	7000	0.66	310
3.9	± 0.2 nH	13	300	7000	0.80	280
4.7	± 0.2 nH	13	300	7000	1.00	250
5.6	± 0.2 nH	10	300	6000	1.60	200

※) Conditions:

Measuring Temperature $24 \pm 2^\circ\text{C}$

Measuring Equipment Impedance Analyzer (HP4191A)

TITLE: HPL0603-※※※ SPECIFICATION	SUSUMU CO.,LTD	SPEC.NO: HL09-4004-E0	Rev. No. 0
			

Fig.1 Dimensions

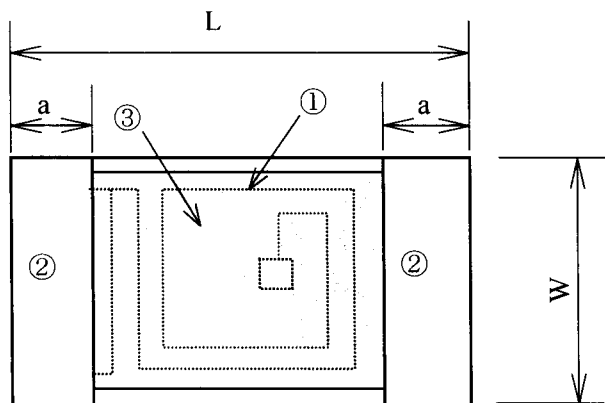

Unit : mm

Code letter	Dimensions
L	0.61±0.05
W	0.31±0.05
t	0.28±0.05
a	0.07±0.05
b	0.12±0.05
u1	0.03 max
u2	0.03 max

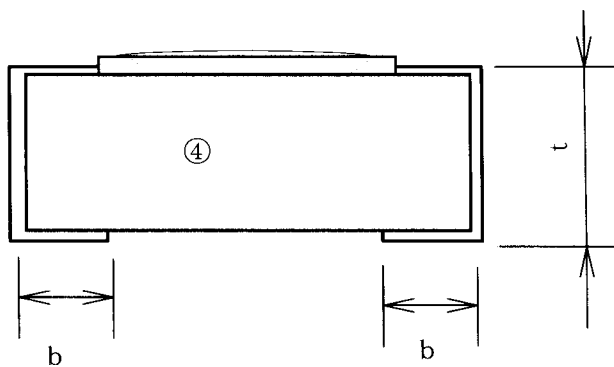

- ①Coil : Cu
- ②Electrode : plating
Sn 100% (Lead-Free)
- ③Protective coat : Epoxy Resin coating
- ④Substrate : Alumina ceramic

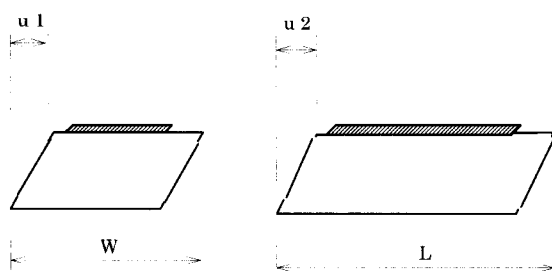

Weight : 0.2mg
(REF.)

TITLE: HPL0603-*** SPECIFICATION	SUSUMU CO.,LTD	SPEC.NO: HL09-4004-E0	Rev. No. 0
	SSM		

5. Performance

5.1. Electrical

Unless otherwise specified, measurements shall be performed under the condition below.
Standard atmospheric conditions.

Temperature: $24 \pm 5^{\circ}\text{C}$ 、Relative humidity: 45 to 85%RH、Atmospheric pressure: 86 to 106 kPa
If there is any doubt about results, the measurement shall be made with the following limits.

Temperature: $24 \pm 2^{\circ}\text{C}$ 、Relative humidity: 60 to 70%RH、Atmospheric pressure: 86 to 106 kPa

Electrical characteristic after testing is established by ΔL and ΔQ .

ΔL	1 ~ 5.6nH	$\pm 5\%$
ΔQ	1 ~ 5.6nH	$\pm 20\%$

Table. 2 Performance

No	Item	Conditions	Specifications
1	Inductance	Measurement shall be performed by Impedance Analyzer 4191A with the frequency specified in Table. 1.	Refer to Table.1.
2	Q	Measurement shall be performed by Impedance Analyzer 4191A with the frequency specified in Table. 1.	Refer to Table.1.
3	DC Resistance	Refer to IEC 60115-1, Sub-clause 4.5.	DC Resistance shall be within specification. (Table. 1)
4	Self Resonance Frequency	Measurement shall be performed by Network Analyzer 8510.	Self resonance frequency shall be within the specified frequency . (Table. 1)
5	Temperature Coefficient	Measurement shall be performed at RT and $+100^{\circ}\text{C}$, and the calculation shall be performed with the measured value .	TCL $0 \sim +125\text{ppm}/^{\circ}\text{C}$ TCQ $-0.25 \sim 0\%/^{\circ}\text{C}$ TCR $0 \sim +0.45\%/^{\circ}\text{C}$
6	Rated Current	Rated current shall be the current with which the temperature raise of the inductor becomes 20°C . (Rated Power) = (Rated Current) ² × (Maximum DC Resistance) Rated ambient temperature : 70°C	Refer to Table.1.

Derating curve

Ambient temperature (°C)	Derating of Rated Power (%)
-40	100
70	100
125	0

TITLE:

HPL0603-※※※※
SPECIFICATION

SUSUMU
CO.,LTD



SPEC.NO:

HL09-4004-E0

Rev. No.

0

Table. 2 Performance (Continued)

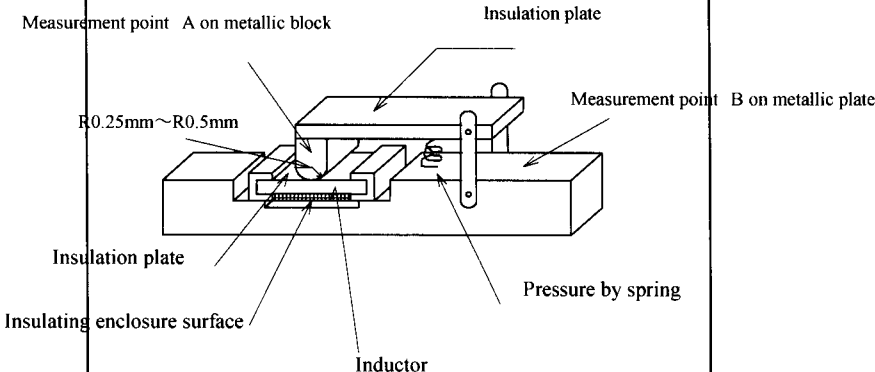
No	Item	Conditions	Specifications
7	Overload	Test current : 2 times of the maximum current Duration : 5 min.	No smoke, fire nor Significant damage Shall be observed.
8	Insulation Resistance	<p>Place the specimen on the groove of metal plate so that the edge of metal block positions almost center of both electrodes, with the surface of insulation enclosure located downward or upward and pressurize the block by a force of 1.0 ± 0.2 N.</p> <p>The test voltage shall be 100 ± 15 V.D.C., and maintain this voltage for about 1 min. The insulation resistance shall then be measured while applying the voltage.</p>  <p>Measurement point A on metallic block</p> <p>Insulation plate</p> <p>R0.25mm~R0.5mm</p> <p>Measurement point B on metallic plate</p> <p>Insulation plate</p> <p>Insulating enclosure surface</p> <p>Inductor</p> <p>Pressure by spring</p> <p>Refer to refer to IEC 60115-1, Sub-clause 4.6.</p>	<p>(1)Between electrodes and insulating enclosure 100MΩ or over.</p> <p>(2)Between electrodes and base material 1000MΩ or over.</p>
9	Voltage Proof (1)Between electrodes and insulating enclosure (2)Between electrodes and base material	<p>The specimen shall be tested as shown in Table. 2.8 Test voltage : 100V (a.c. r.m.s.) for 60 ± 5 sec.</p> <p>Refer to IEC 60115-1, Sub-clause 4.7.</p>	<p>No mechanical damage shall be observed. Electric characteristics shall be within specification.</p>

TITLE:

HPL0603-***
SPECIFICATIONSUSUMU
CO.,LTD



SPEC.NO:

HL09-4004-E0

Rev. No.

0

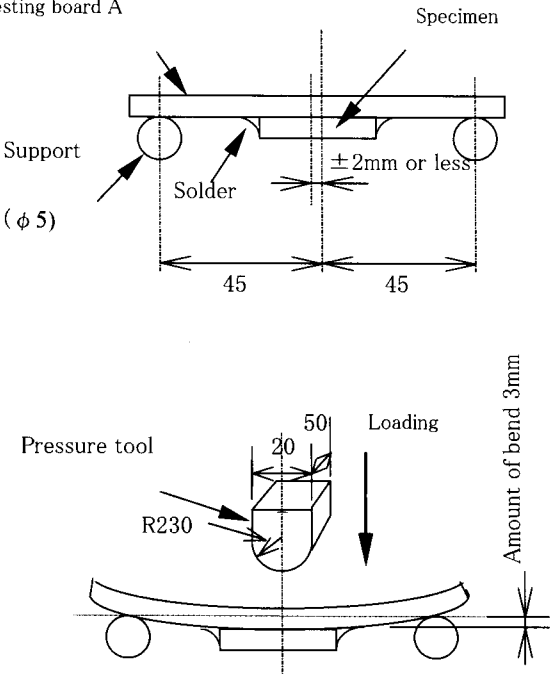
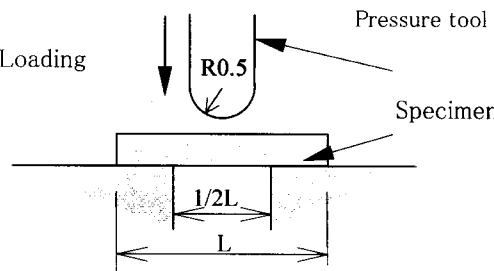
Table. 2 Performance (Continued)

No	Item	Conditions	Specifications
10	Substrate bending test (Bond strength of the face plating)	<p>Apply pressure in the direction of the arrow at a rate of about 1mm/s until bent width reaches 3 mm and hold for 30s. Use for Testing board A.</p> <p>Testing board A</p>  <p>Support (φ 5)</p> <p>Solder</p> <p>± 2mm or less</p> <p>45</p> <p>45</p> <p>Pressure tool</p> <p>50</p> <p>20</p> <p>R230</p> <p>Loading</p> <p>Amount of bend 3mm</p> <p>Refer to IEC 60115-1, Sub-clause 4.33.</p>	<p>No mechanical damage such as breaks.</p> <p>DC Resistance Characteristics shall be within specification.</p>
11	Body strength	<p>A load of 10 N {1.02kgf} using a R0.5 pressure rod shall be applied to the center in the direction of arrow and held for 10 ± 1s.</p>  <p>Loading</p> <p>Pressure tool</p> <p>R0.5</p> <p>Specimen</p> <p>1/2L</p> <p>L</p>	<p>No mechanical damage shall be observed.</p> <p>Electric characteristics shall be within specification.</p>

TITLE:

HPL0603-***
SPECIFICATIONSUSUMU
CO.,LTD

SSM

SPEC.NO:

HL09-4004-E0

Rev. No.

0

Table. 2 Performance (Continued)

No	Item	Conditions	Specifications
12	Resistance to soldering heat	<p>(1) Solder bath method Pre-heat : 100 to 110°C 30 sec. Temperature : 270±5°C 10±1 sec.</p> <p>(2) Reflow soldering method Peak temperature : 260±5°C 10 sec. or less Temperature : 220±5°C 60 sec. max. 2 cycles or less The temperature shall be board surface temperature.</p> <p>(3) Soldering iron method Bit Temperature : 350±5°C Time 時間 : 3+1/0sec</p> <p>The specimen shall be stored at standard atmospheric conditions for 1 hr after which the measurements shall be made.</p> <p>Refer to IEC 60115-1, Sub-clause 4.18.</p>	<p>No mechanical damage shall be observed. Electric characteristics shall be within specification.</p>
13	Solderability	<p>Solder temperature : 235±5°C Duration of immersion : 2±0.5sec Sn-Pb solder</p> <p>Refer to IEC 60115-1, Sub-clause 4.17.</p> <hr/> <p>Solder temperature : 245±5°C Duration of immersion : 2±0.5sec Sn-3Ag-0.5Cu solder</p> <p>Refer to IEC 60115-1, Sub-clause 4.17.</p>	<p>A new uniform coating of solder shall cover a minimum of 95% of the surface being immersed.</p>
14	Solvent Resistance	<p>Immersion cleaning At normal temperature, 5min Isopropyl alcohol</p> <p>Refer to IEC 60115-1, Sub-clause 4.29.</p>	<p>Without distinct damage in appearance.</p>

TITLE:

HPL0603-***
SPECIFICATION

SUSUMU
CO.,LTD



SPEC.NO:

HL09-4004-E0

Rev. No.

0

Table. 2 Performance (Continued)

No	Item	Conditions	Specifications		
15	Rapid change of temperature	The inductor shall be subjected to 5 continuous cycles, each as shown in the figure below.	No mechanical damage shall be observed. Electric characteristics shall be within specification.		
				Temperature	Time
		1		$-40 \pm 3^{\circ}\text{C}$	30min
		2		R.T	2~3 min
		3		$+125 \pm 2^{\circ}\text{C}$	30min
4	R.T	2~3min			
		Use for Testing board B. R.T. =Room Temperature Refer to IEC 60115-1, Sub-clause 4.19.			
16	Endurance (Damp heat with load)	$60 \pm 2^{\circ}\text{C}$ with relative humidity of 90 to 95% D.C. rated current for 90 min on 30 min off 1000+48/0 h. Use for Testing board B.	No mechanical damage shall be observed. Electric characteristics shall be within specification.		
17	Endurance (rated load)	$70 \pm 2^{\circ}\text{C}$ D.C. rated current for 90 min on 30 min off 1000 +48/0 h. Use for Testing board B. Refer to IEC 60115-1, Sub-clause 4.25.	No mechanical damage shall be observed. Electric characteristics shall be within specification.		

TITLE:	HPL0603-*** SPECIFICATION	SUSUMU CO.,LTD 	SPEC.NO: HL09-4004-E0	Rev. No. 0
--------	------------------------------	--	--------------------------	---------------

Fig.3 Test Board B (For another test)

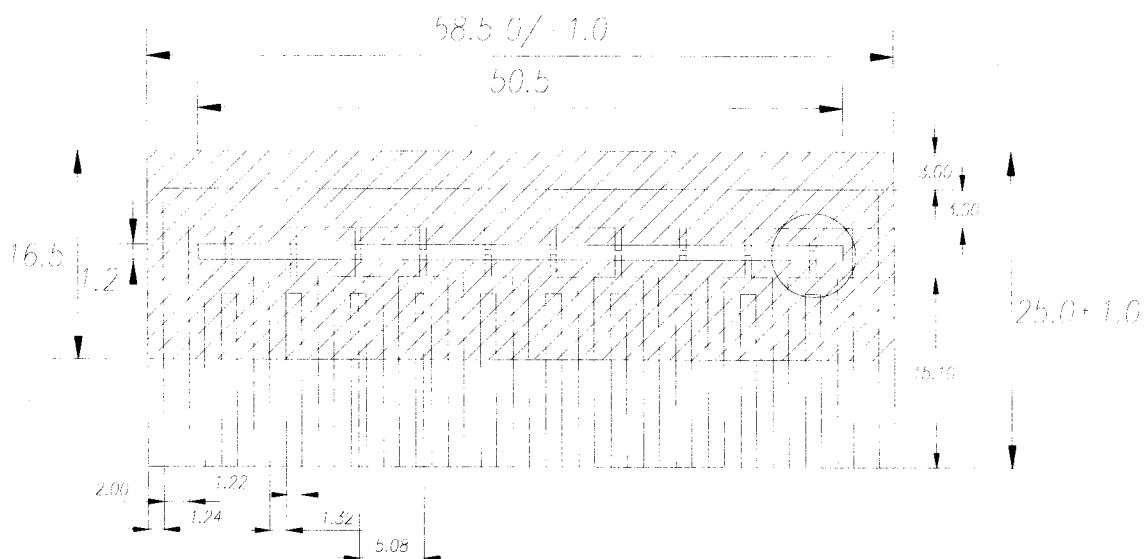

Unit : mm

 = Solder resist

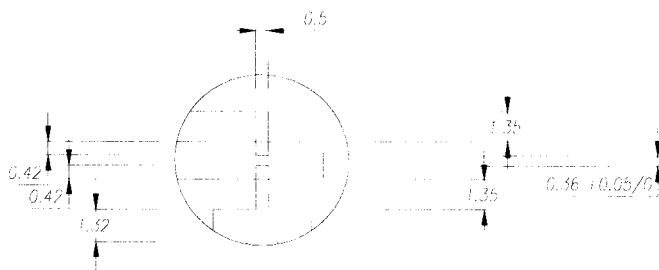

6. Packaging

The inductors shall be in Taping.

6.1. Dimensions

- (1) Tape packaging dimensions : See Fig.4
- (2) Reel dimensions : See Fig.5
- (3) For other dimensions, refer to EIAJ ET-7200A.

TITLE:	HPL0603-***	SUSUMU CO.,LTD	SPEC.NO:	Rev. No.
	SPECIFICATION		HL09-4004-E0	0

6.2. Materials

- (1) Tape : Paper
- (2) Reel : Plastic

6.3. Specification of taping

Refer to paragraph 6.1 and JIS C 0806.

6.4. Pieces per reel

5,000 piece / reel

6.5. Marking

The label indicated following items shall be marked on single side of the reel.

- ① Type designation
- ② Quantity
- ③ Manufacturing date code
(Month and year are marked. Refer to JIS C 5201-1 Annex 1 Table5.)
- ④ Manufacturer's name
- ⑤ The country of origin
- ⑥ Shipping number
- ⑦ Identification showing lead-free products.

【Label Example】

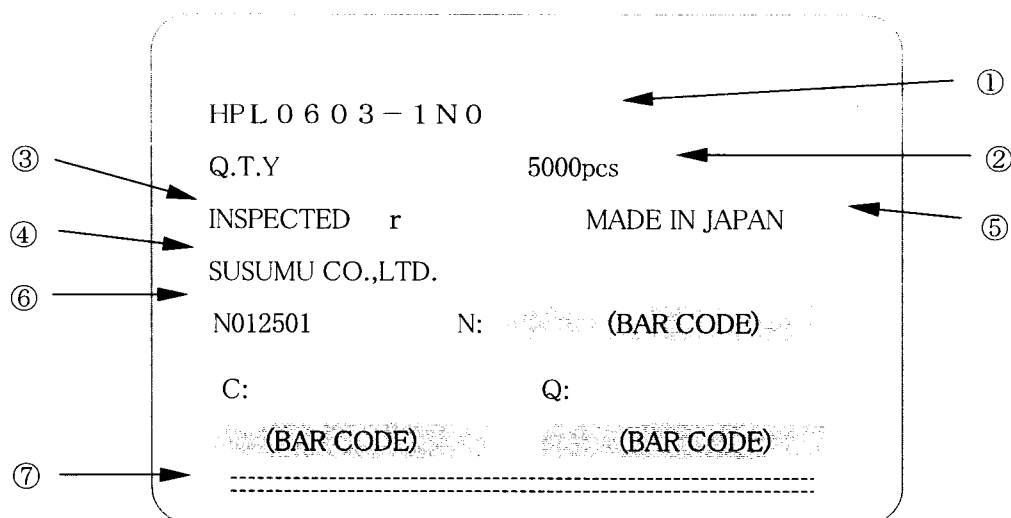

TITLE:	HPL0603-***	SUSUMU CO.,LTD	SPEC.NO:	Rev. No.
	SPECIFICATION	SSM	HL09-4004-E0	0

Fig.4 Dimensions of taping

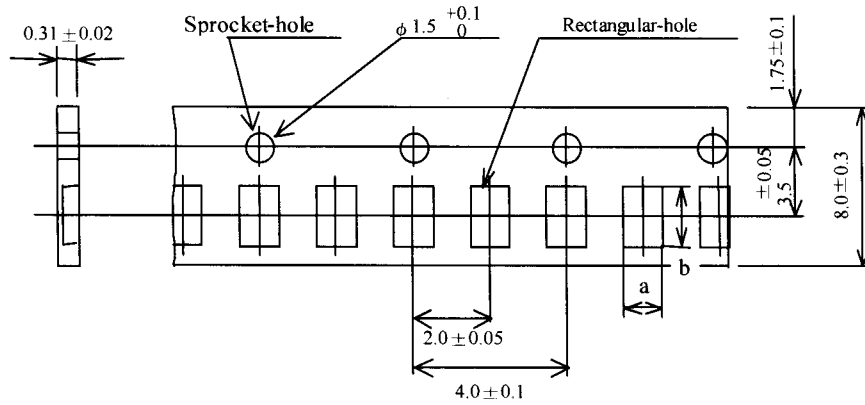

※ “Bottom less type” of tape is used.

※Pre-empted holes : 150 holes(or 30 cm) or more.

Code letter	a	b
Dimension	0.38 ± 0.03	0.68 ± 0.03

Unit : mm

Fig.5 Dimensions of reel

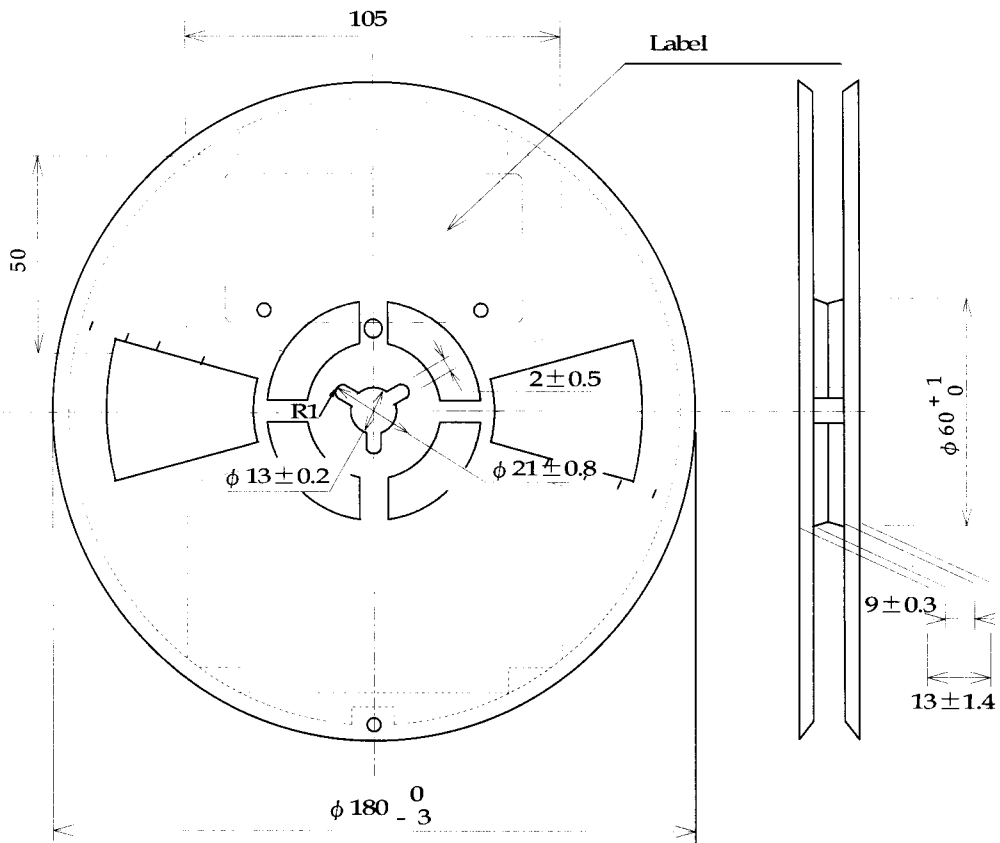

Plastic Reel Thickness : 0.5mm.
 Plastic Reel : Correspond with EIAJ RRV08B

Unit : mm

TITLE: HPL0603-※※※ SPECIFICATION	SUSUMU CO.,LTD	SPEC.NO:	Rev. No.
	SSM	HL09-4004-E0	0

7. Precautions in use

7.1 Storage

- (1) The product shall be stored in a room where temperature and humidity must be controlled.
(temperature 5 to 35 °C, humidity 45 to 85 % RH)
However, humidity keeps it low, as it is possible.
- (2) The product shall be stored as direct sunshine doesn't hit on it.
- (3) The product shall be stored with no moisture, dust, a material that will make solderability inferior, and a harmful gas (hydrogen chloride, sulfurous acid gas, and hydrogen sulfide).
- (4) The product shall be stored as tape packaging condition.

7.2 Term for use

- (1) The term for use is within one year from the shipping day of the product.
- (2) If the product has been left unused for more than one year after delivered, check solderability before use.

7.3 Chip mounting

- (1) When chip are mounted on the PC board, the protective coat of the product must not be scratched. If it will be scratched, it will make characteristic inferior.
- (2) In case that product will be soldered by soldering iron, heating shall be done on the land, and soldering iron must not hit on the product itself.
- (3) In case that resin coating or resin seal will be made for a PC board after chip mounting, do washing and drying it enough before coating or sealing. If ion bear or moisture will be sealed in resin coating, it will make characteristic inferior.
- (4) For resinous use, it is necessary to set up enough the curing conditions. As it gets improper for the condition, changes of a resistance value are large and are a case.
- (5) According to shape, material, and pressure of clamping in chip mounting machine, there is the case that crack will be appeared on the product.
Control a shock energy for clamping the product under 7×10^{-4} J.
With a shock energy around clamping that says here, it is suited to a potential energy, in case that iron block of 25g is dropped naturally to the product placed on iron plate for the height of 2.8mm.
- (6) The glue to fix the product on the PC board around chip mounting, it is needed high insulation resistance and great performance or moisture. And it is needed that these characteristics are not inferior in using temperature range and a hot spot temperature to be acting.



7.4 Using and Handling

- (1) It is necessary to investigate the performance and reliability enough when using under harsh environment.
- (2) It is necessary to protect the edge and protective coat of the product from mechanical stress.
- (3) Handle with care when PC board is divided or fixed on support body, because bending of PC board after chip mounting will make mechanical stress for the product.
- (4) The product shall be used within rated range shown in specification.
Especially, if current more than specified value will be loaded to the product, there is a case it will make damage for machine because of temperature rise depending on generation of heat, and characteristic inferior.
- (5) In case that product is loaded a rated current, it is necessary to confirm temperature of the product and to reduce a load current according to load reduction curve, because a temperature rise of the product depends on influence of heat from mounting density and neighboring element.
- (6) If there is a possibility that a large voltage (pulse voltage, shock voltage) charge to the product, it is necessary that operating condition shall be set up before use, because performance of the product is affected by a large shock voltage.
- (7) The items listed in the specifications assure the product quality as the product alone.
Evaluation and confirmation of the product quality after mounting, in accordance with the operation condition, is required for actual use.







TITLE:	HPL0603-***	SUSUMU CO.,LTD	SPEC.NO:	Rev. No.
	SPECIFICATION		HL09-4004-E0	0

Looking for pricing, stock, or lifecycle information?

Click below to explore more details on WIN SOURCE:

-  [View HPL0603-1N8 on WIN SOURCE](#)
-  [Susumu Information](#)

Optimize Your Supply Chain with WIN SOURCE Solutions

-  Global Sourcing Solution
-  Obsolete Management
-  Cost Control Management
-  Shortage Management
-  Alternative Solution
-  Excess Inventory Management