



THE DATASHEET OF HMC990LP4ETR





BROADBAND HIGH IP3 DUAL CHANNEL DOWNCONVERTER, 0.7 - 3.5 GHz

Typical Applications

The HMC990LP4E is Ideal for:

- Multiband/Multi-standard Cellular BTS Diversity Receivers
- GSM & 3G & LTE/WIMAX/4G
- MIMO Infrastructure Receivers
- Wideband Radio Receivers
- Multiband Basestations & Repeaters

Features

- Broadband Operation with no external matching
- Industry's Most Compact Solution, 4x4 mm² QFN Package
- High-side and Low-side LO injection Operation
- Wide IF Frequency Range
- High Input IP3 of +25.6dBm @ 2200 MHz
- Power Conversion Gain of 7.9 dB
- Input P1dB of 12 dBm
- SSB Noise Figure of 9 dB
- 55 dBc Channel-to-Channel Isolation
- Dedicated Enable Pins for IF & LO amplifiers
- Single-ended RF & LO input ports

Functional Diagram

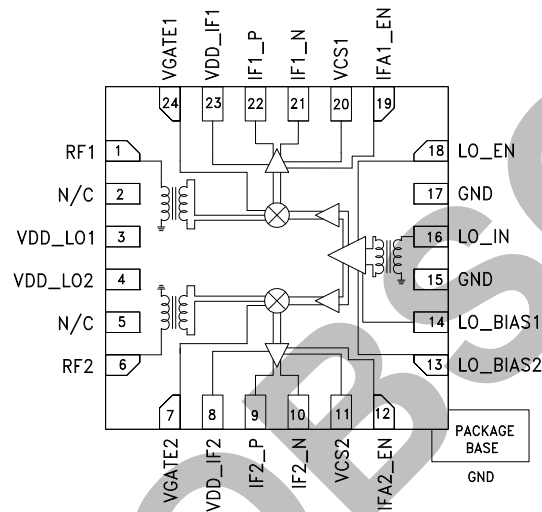

General Description

The HMC990LP4E is a high linearity, dual channel down-converting mixer optimized for multi-standard diversity receiver applications that require low power consumption and small size. The HMC990LP4E features new wideband limiting LO amplifiers to achieve an unprecedented RF bandwidth of 700 MHz to 3500 MHz. Unlike conventional narrow-band downconverter RFICs, the HMC990LP4E supports both high-side and low-side LO injection over the entire RF frequency band. The RF and LO input ports are internally matched to 50Ω.

The HMC990LP4E integrates LO and IF amplifiers with enable functions, LO and RF baluns and high linearity passive mixer cores with bias control interface. The balanced passive mixer combined with high-linearity IF amplifier architecture of HMC990LP4E provides excellent LO-to-RF, LO-to-IF, and RF-to-IF isolations. The HMC990LP4E provides a very low noise figure of 9dB, and high IIP3 of +25.6dBm allowing device to be used in demanding wideband applications. The HMC990LP4E's input IP3 can be further improved by external matching for narrow-band applications. The HMC990LP4E has typical less than 1.5W power consumption which can be optimized through external bias control pins. The HMC990LP4E also features a very fast enable control interface for to be used for power saving in Time Division Duplex (TDD) applications. The HMC990LP4E is housed in a RoHS compliant 4x4 mm² leadless QFN package.

All plots are for Low Side LO injection unless otherwise noted. Balun losses at IF output ports are de-embedded.

Information furnished by Analog Devices is believed to be accurate and reliable. However, no responsibility is assumed by Analog Devices for its use, nor for any infringements of patents or other rights of third parties that may result from its use. Specifications subject to change without notice. No license is granted by implication or otherwise under any patent or patent rights of Analog Devices. Trademarks and registered trademarks are the property of their respective owners.

For price, delivery, and to place orders: Analog Devices, Inc., One Technology Way, P.O. Box 9106, Norwood, MA 02062-9106
 Phone: 781-329-4700 • Order online at www.analog.com
 Application Support: Phone: 1-800-ANALOG-D



BROADBAND HIGH IP3 DUAL CHANNEL DOWNCONVERTER, 0.7 - 3.5 GHz

Electrical Specifications, $T_A = +25\text{ }^\circ\text{C}$, IF Frequency = 150 MHz, LO Power = 0 dBm, RF Input Power = -5dBm (-5 dBm / Tone for 2-Tone IP3 Tests, $\Delta f = 1\text{ MHz}$), VDD_LO1,2 = 3.3V, VDD_IF^[3], VDD_IF1,2 = 5V

Parameter	Typical				Units
RF Input Frequency Range	700 - 3500				MHz
LO Input Frequency Range	600 - 3800				MHz
IF Output Frequency Range ^[10]	10 - 470				MHz
	RF=900 MHz ^[1]	RF=1900 MHz ^{[2] [9]}	RF=2200 MHz ^[2]	RF=2700 MHz ^[2]	
Parameter	Typ.	Typ.	Typ.	Typ.	Units
Conversion Gain ^[8]	8.7	7.9	7.3	6.9	dB
IP3 (Input)	25.1	25.0	25.6	24.3	dBm
Noise Figure (SSB)	8.9	9.3	10.0	10.3	dB
1 dB Compression (Input)	11.2	12.0	12.0	12.3	dBm
LO leakage @ RF port	-53	-52	-51	-60	dBm
RF to IF Isolation	45	41	42	42	dB
LO Input Return Loss	-12	-13	-12	-11	dB
RF Input Return Loss	-11	-13	-15	-17	dB
IF Input Return Loss	-12	-12	-12	-12	dB
Channel to Channel Isolation	62	53	52	52	dBc
+2RF-2LO Response	69	68	71	69	dBc
+3RF-3LO Response	70	70	72	78	dBc
LO Input Drive Level	-6 to +3	-6 to +3	-6 to +3	-6 to +3	dBm
LO to IF Isolation ^[11]	-38	-38	-38	-38	dBc

Typical RF Narrow Band Matching Performance

See Application Section for Further Details

Parameter	Typ.	Units
Frequency Range	1850 - 2050	MHz
Conversion Gain	7.9	dB
IIP3	25	dBm
NF (SSB)	9.3	dB
IP1dB	12	dBm
RF to IF Isolation	41	dB
Channel to Channel Isolation	53	dBc
LO Input Drive Level	-6 to +3	dBm

All plots are for Low Side LO injection unless otherwise noted. Balun losses at IF output ports are de-embedded.

Information furnished by Analog Devices is believed to be accurate and reliable. However, no responsibility is assumed by Analog Devices for its use, nor for any infringements of patents or other rights of third parties that may result from its use. Specifications subject to change without notice. No license is granted by implication or otherwise under any patent or patent rights of Analog Devices. Trademarks and registered trademarks are the property of their respective owners.

For price, delivery, and to place orders: Analog Devices, Inc., One Technology Way, P.O. Box 9106, Norwood, MA 02062-9106
Phone: 781-329-4700 • Order online at www.analog.com
Application Support: Phone: 1-800-ANALOG-D

**BROADBAND HIGH IP3 DUAL CHANNEL DOWNCONVERTER,
0.7 - 3.5 GHz**
DC Power Supply Specifications,

Parameter	Conditions	Min.	Typ.	Max.	Units.
IF Supply Voltage (VDD_IF ^[3] , VDD_IF1,2 ^[4])		+4.75	+5	+5.25	V
LO Supply Voltage (VDD_LO1,2)		+3.15	+3.3	+3.45	V
IF Amplifier Supply Current when enabled	VDD_IF ^[3]		148		mA
	VDD_IF1 ^[4] + VDD_IF2 ^[4]		24		mA
	VCS1 ^[5] + VCS2 ^[5]		3		mA
IF Amplifier Supply Current when disabled	VDD_IF ^[3]		0		mA
	VDD_IF1 ^[4] + VDD_IF2 ^[4]		3		mA
	VCS1 ^[5] + VCS2 ^[5]		4		mA
LO Amplifier Supply Current when enabled	VDD_LO1,2		170		mA
	LO_BIAS1 ^[6] + LO_BIAS2 ^[6]		4.6		mA
LO Amplifier Supply Current when disabled	VDD_LO1,2		4		mA
	LO_BIAS1 ^[6] + LO_BIAS2 ^[6]		5.4		mA
Vgate Bias when enabled	VGATE1 + VGATE2		3.6		mA
Vgate Bias when disabled	VGATE1 + VGATE2		2		mA

All plots are for Low Side LO injection unless otherwise noted. Balun losses at IF output ports are de-embedded.

Information furnished by Analog Devices is believed to be accurate and reliable. However, no responsibility is assumed by Analog Devices for its use, nor for any infringements of patents or other rights of third parties that may result from its use. Specifications subject to change without notice. No license is granted by implication or otherwise under any patent or patent rights of Analog Devices. Trademarks and registered trademarks are the property of their respective owners.

For price, delivery, and to place orders: Analog Devices, Inc.,
One Technology Way, P.O. Box 9106, Norwood, MA 02062-9106
Phone: 781-329-4700 • Order online at www.analog.com
Application Support: Phone: 1-800-ANALOG-D

BROADBAND HIGH IP3 DUAL CHANNEL DOWNCONVERTER, 0.7 - 3.5 GHz



LO/IF, Enable/Disable Interface Specifications,

Parameter	Conditions	Min.	Typ.	Max.	Units.
LO_EN High Level	LO Amplifier Disabled	+3	+5		V
LO_EN Low Level	LO Amplifier Enabled	0	0	+1	V
IFA1_EN / IFA2_EN High Level	Channel1/2 IF Amplifier Disabled	+3	+5	5	V
IFA1_EN / IFA2_EN Low Level	Channel1/2 IF Amplifier Enabled	0	0	+1	V
Enable Settling Time ^[7]			30		ns
Disable Settling Time ^[7]			130		ns

- [1] High side LO injection, VGATE1,2 = 5.0V [2] Low side LO injection, VGATE1,2 = 4.8V
 [3] Supply voltage for IF amplifiers through choke inductors. See application circuit.
 [4] Supply voltage for bias circuit of IF amplifiers. See application circuit.
 [5] Bias Control pins for IF amplifiers. See application circuit.
 [6] Bias Control pins for LO amplifier. See application circuit.
 [7] Remove bypass capacitors on LO_EN and IFA1,2_EN pins for given settling times. See application circuit.
 [8] Balun losses at IF output port are de-embedded.
 [9] 1900 MHz matching band covers 1850 - 2050 MHz
 [10] The part is characterized with IF = 150 MHz. External matching maybe needed for different IF frequencies.
 [11] LO Power is 0 dBm, RF Power is -5 dBm.

OBSOLETE

All plots are for Low Side LO injection unless otherwise noted. Balun losses at IF output ports are de-embedded.

Information furnished by Analog Devices is believed to be accurate and reliable. However, no responsibility is assumed by Analog Devices for its use, nor for any infringements of patents or other rights of third parties that may result from its use. Specifications subject to change without notice. No license is granted by implication or otherwise under any patent or patent rights of Analog Devices. Trademarks and registered trademarks are the property of their respective owners.

For price, delivery, and to place orders: Analog Devices, Inc.,
 One Technology Way, P.O. Box 9106, Norwood, MA 02062-9106
 Phone: 781-329-4700 • Order online at www.analog.com
 Application Support: Phone: 1-800-ANALOG-D



**BROADBAND HIGH IP3 DUAL CHANNEL DOWNCONVERTER,
0.7 - 3.5 GHz**

MIXERS - SMT

Conversion Gain vs. VGATE^[1]

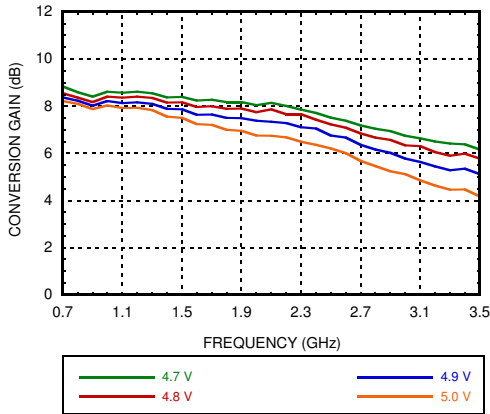

Input IP3 vs. VGATE^[1]

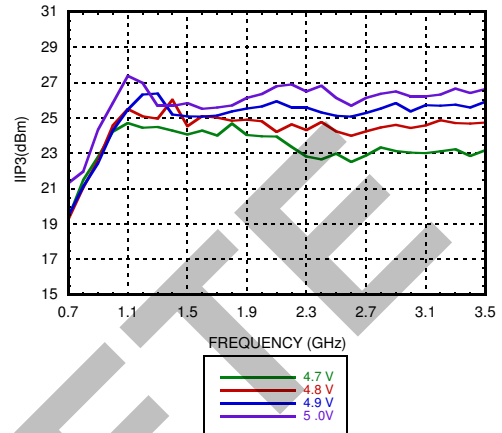

+2RF -2LO Response vs. VGATE^[1]

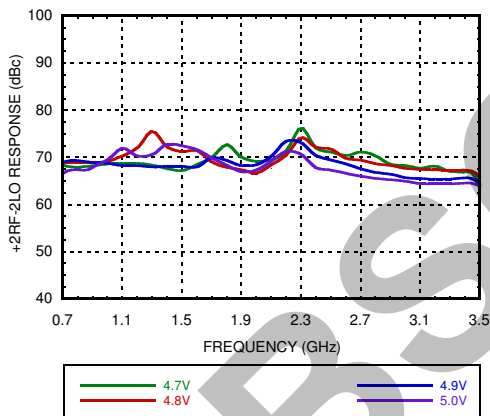

+3RF -3LO Response vs. VGATE^[1]

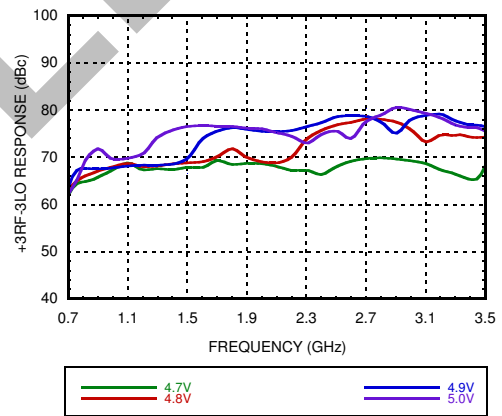

Noise Figure vs. VGATE^[1]

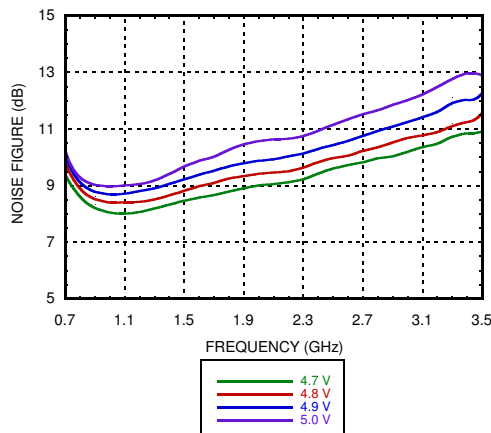

[1] VGATE is bias voltage for passive mixer cores (VGATE1 and VGATE2 pins). Refer to pin description table. All plots are for Low Side LO injection unless otherwise noted. Balun losses at IF output ports are de-embedded.

Information furnished by Analog Devices is believed to be accurate and reliable. However, no responsibility is assumed by Analog Devices for its use, nor for any infringements of patents or other rights of third parties that may result from its use. Specifications subject to change without notice. No license is granted by implication or otherwise under any patent or patent rights of Analog Devices. Trademarks and registered trademarks are the property of their respective owners.

For price, delivery, and to place orders: Analog Devices, Inc., One Technology Way, P.O. Box 9106, Norwood, MA 02062-9106 Phone: 781-329-4700 • Order online at www.analog.com Application Support: Phone: 1-800-ANALOG-D



BROADBAND HIGH IP3 DUAL CHANNEL DOWNCONVERTER, 0.7 - 3.5 GHz

Conversion Gain vs. High Side LO & Low Side LO @ VGATE=4.8V

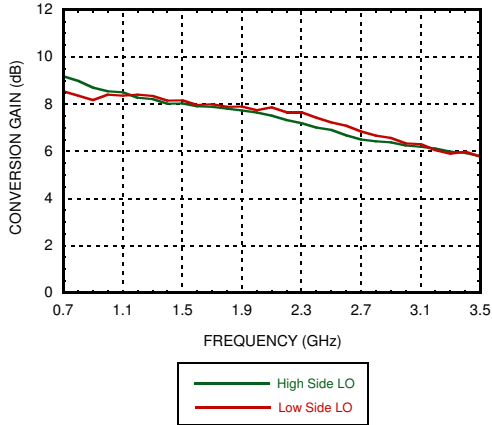

Input IP3 vs. High Side LO & Low Side LO @ VGATE=4.8V

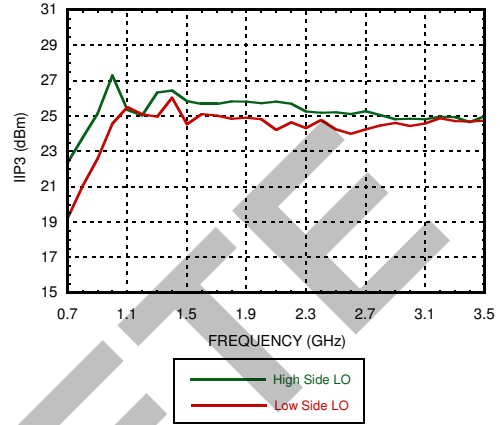

RF/IF Isolation vs. Temperature @ VGATE=4.8V

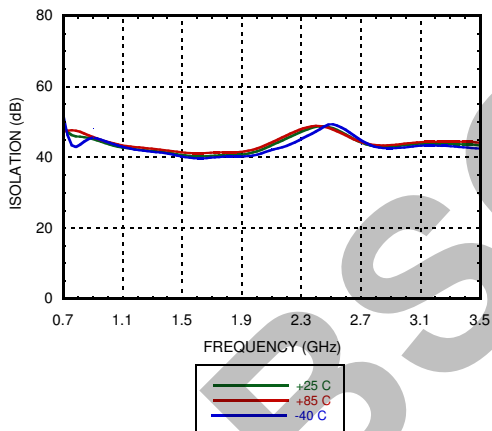

LO Leakage @ VGATE=4.8V

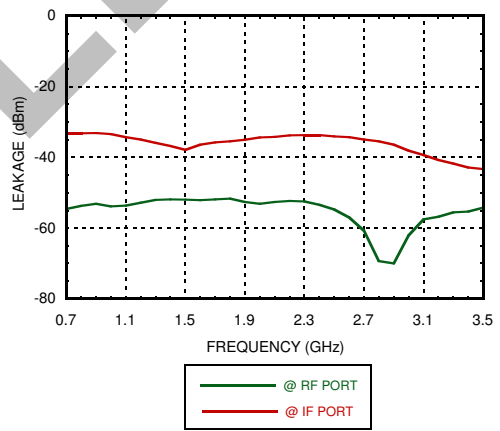

Conversion Gain vs. LO Drive @ VGATE=4.8V

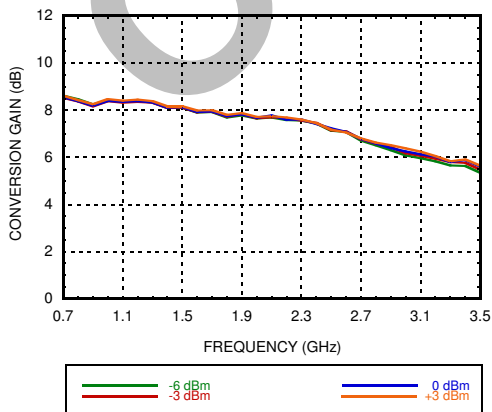

Input IP3 vs. LO Drive @ VGATE=4.8V

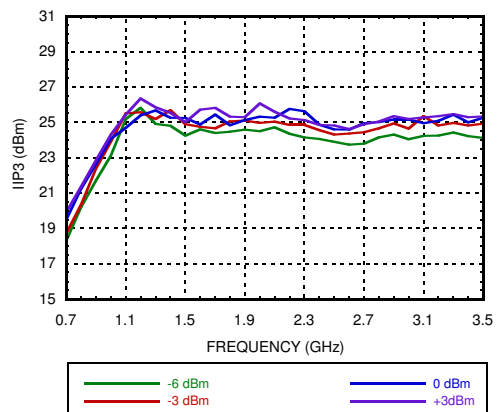

All plots are for Low Side LO injection unless otherwise noted. Balun losses at IF output ports are de-embedded.

Information furnished by Analog Devices is believed to be accurate and reliable. However, no responsibility is assumed by Analog Devices for its use, nor for any infringements of patents or other rights of third parties that may result from its use. Specifications subject to change without notice. No license is granted by implication or otherwise under any patent or patent rights of Analog Devices. Trademarks and registered trademarks are the property of their respective owners.

For price, delivery, and to place orders: Analog Devices, Inc., One Technology Way, P.O. Box 9106, Norwood, MA 02062-9106 Phone: 781-329-4700 • Order online at www.analog.com Application Support: Phone: 1-800-ANALOG-D



**BROADBAND HIGH IP3 DUAL CHANNEL DOWNCONVERTER,
0.7 - 3.5 GHz**

MIXERS - SMT

**+2RF -2LO Response vs.
LO Drive @ VGATE=4.8V**

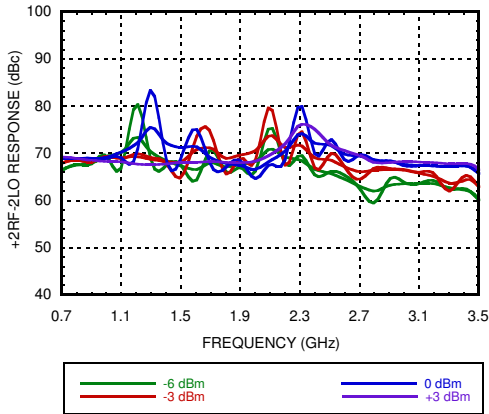

**+3RF -3LO Response vs.
LO Drive @ VGATE=4.8V**

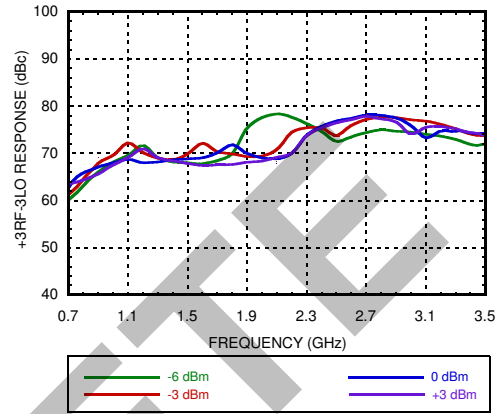

RF Input Return Loss @ VGATE=4.8V [1]

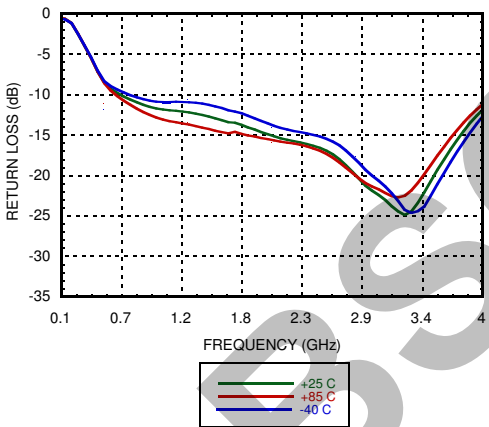

LO Input Return Loss @ VGATE=4.8V

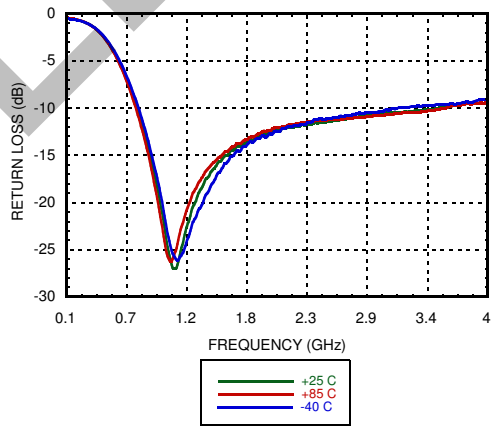

IF Output Return Loss @ VGATE=4.8V [1]

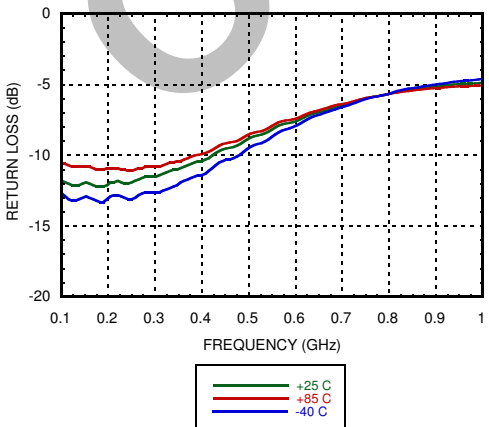

**Input P1dB vs.
Temperature @ VGATE=4.8V**

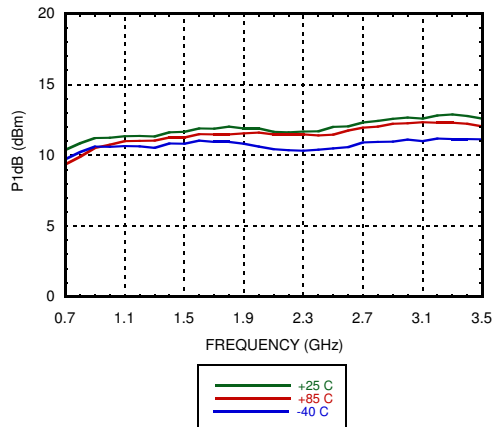

[1] LO input Frequency = 1500MHz, LO power = 0 dBm.
All plots are for Low Side LO injection unless otherwise noted. Balun losses at IF output ports are de-embedded.

Information furnished by Analog Devices is believed to be accurate and reliable. However, no responsibility is assumed by Analog Devices for its use, nor for any infringements of patents or other rights of third parties that may result from its use. Specifications subject to change without notice. No license is granted by implication or otherwise under any patent or patent rights of Analog Devices. Trademarks and registered trademarks are the property of their respective owners.

For price, delivery, and to place orders: Analog Devices, Inc., One Technology Way, P.O. Box 9106, Norwood, MA 02062-9106 Phone: 781-329-4700 • Order online at www.analog.com Application Support: Phone: 1-800-ANALOG-D



BROADBAND HIGH IP3 DUAL CHANNEL DOWNCONVERTER, 0.7 - 3.5 GHz

Conversion Gain vs. Temperature @ VGATE=5.0V

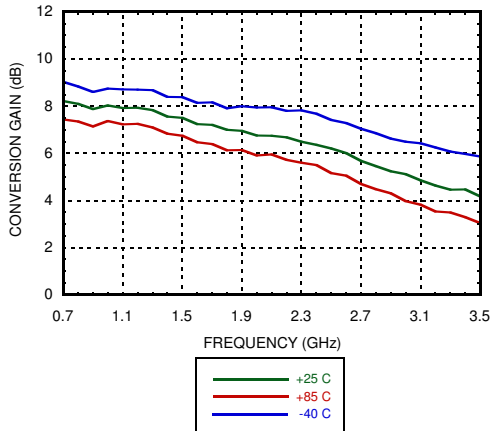

Input IP3 vs. Temperature @ VGATE=5.0V

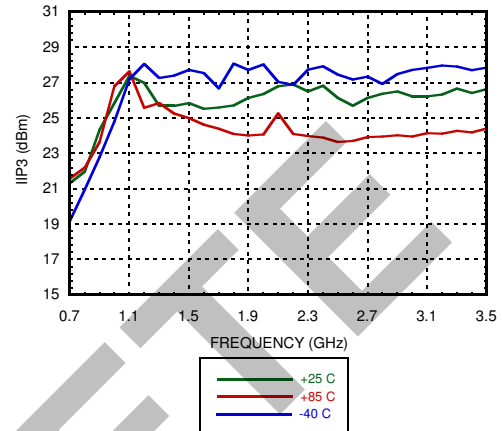

+2RF -2LO Response vs. Temperature @ VGATE=5.0V

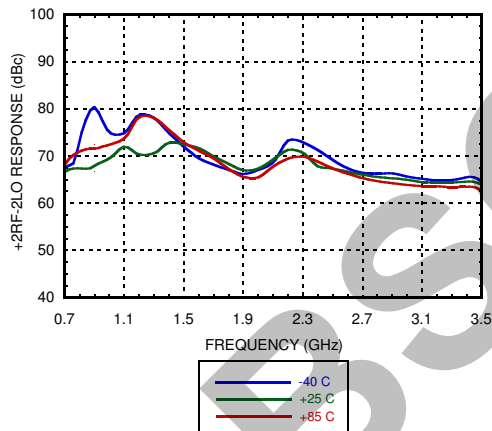

+3RF -3LO Response vs. Temperature @ VGATE=5.0V

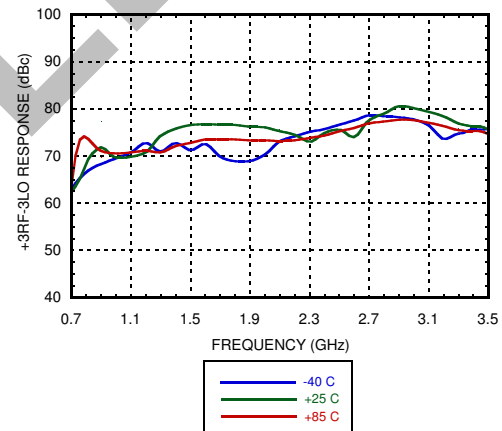

Noise Figure vs. Temperature @ VGATE=5.0V

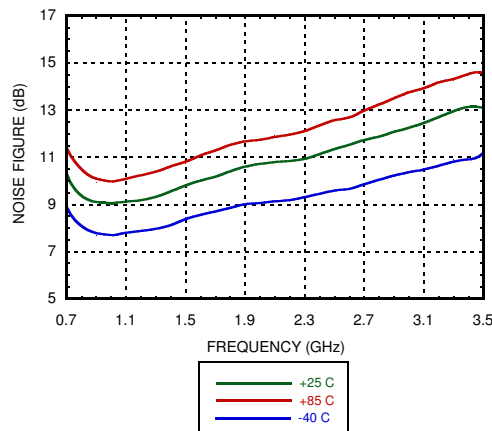

All plots are for Low Side LO injection unless otherwise noted. Balun losses at IF output ports are de-embedded.

Information furnished by Analog Devices is believed to be accurate and reliable. However, no responsibility is assumed by Analog Devices for its use, nor for any infringements of patents or other rights of third parties that may result from its use. Specifications subject to change without notice. No license is granted by implication or otherwise under any patent or patent rights of Analog Devices. Trademarks and registered trademarks are the property of their respective owners.

For price, delivery, and to place orders: Analog Devices, Inc., One Technology Way, P.O. Box 9106, Norwood, MA 02062-9106 Phone: 781-329-4700 • Order online at www.analog.com Application Support: Phone: 1-800-ANALOG-D



**BROADBAND HIGH IP3 DUAL CHANNEL DOWNCONVERTER,
0.7 - 3.5 GHz**

MIXERS - SMT

**Conversion Gain vs. Temperature
@ VGATE=4.9V**

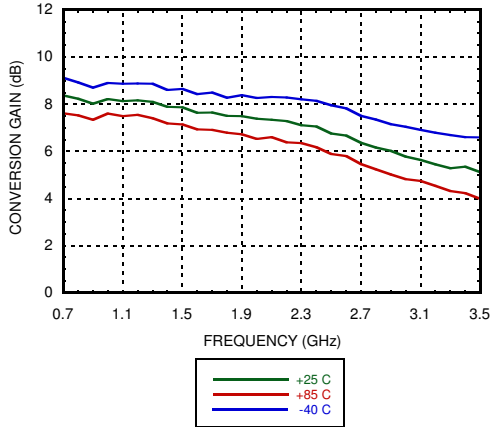

**Input IP3 vs. Temperature
@ VGATE=4.9V**

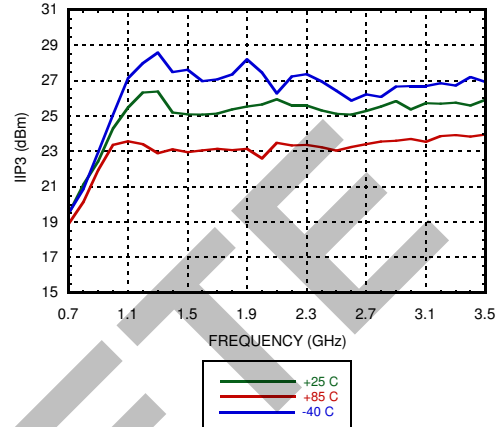

**+2RF -2LO Response vs. Temperature
@ VGATE=4.9V**

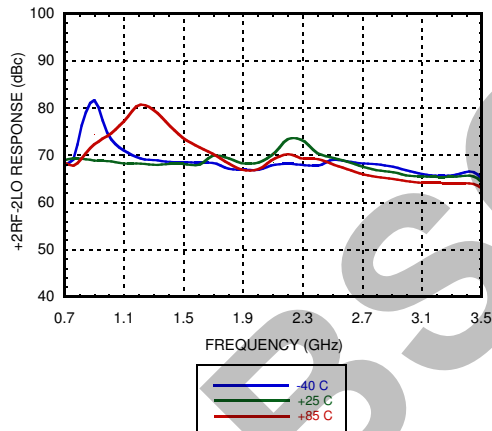

**+3RF -3LO Response vs. Temperature
@ VGATE=4.9V**

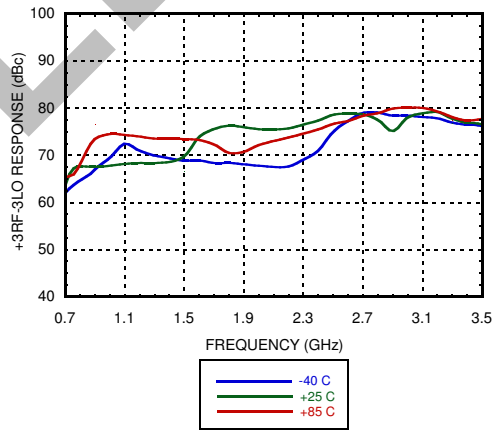

**Noise Figure vs. Temperature
@ VGATE=4.9V**

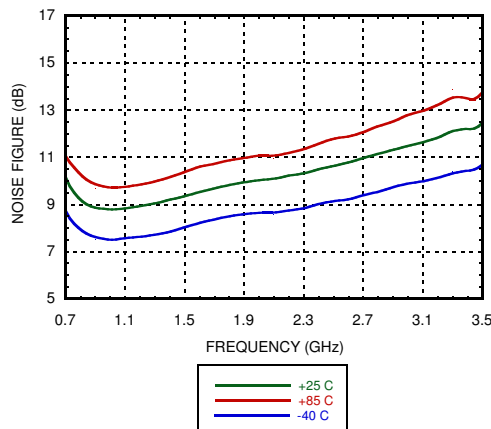

All plots are for Low Side LO injection unless otherwise noted. Balun losses at IF output ports are de-embedded.

Information furnished by Analog Devices is believed to be accurate and reliable. However, no responsibility is assumed by Analog Devices for its use, nor for any infringements of patents or other rights of third parties that may result from its use. Specifications subject to change without notice. No license is granted by implication or otherwise under any patent or patent rights of Analog Devices. Trademarks and registered trademarks are the property of their respective owners.

For price, delivery, and to place orders: Analog Devices, Inc., One Technology Way, P.O. Box 9106, Norwood, MA 02062-9106 Phone: 781-329-4700 • Order online at www.analog.com Application Support: Phone: 1-800-ANALOG-D



**BROADBAND HIGH IP3 DUAL CHANNEL DOWNCONVERTER,
0.7 - 3.5 GHz**

**Conversion Gain vs. Temperature
@ VGATE=4.8V**

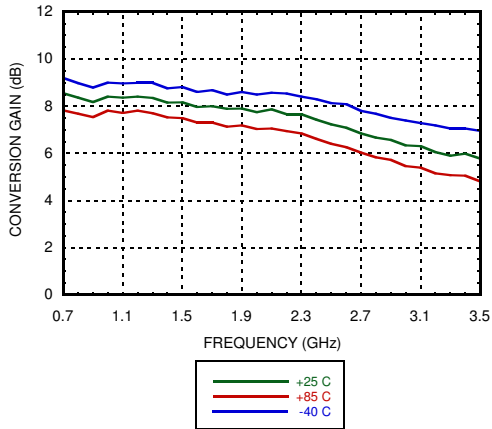

**Input IP3 vs. Temperature
@ VGATE=4.8V**

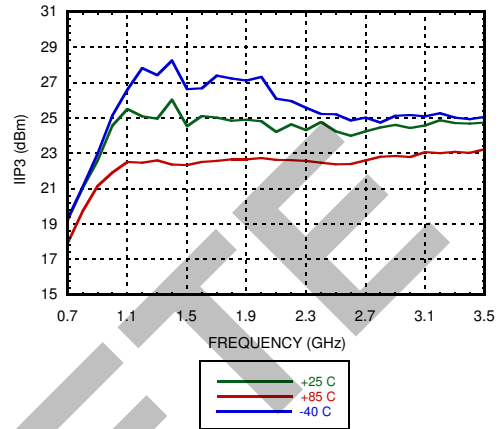

**+2RF -2LO Response vs. Temperature
@ VGATE=4.8V**

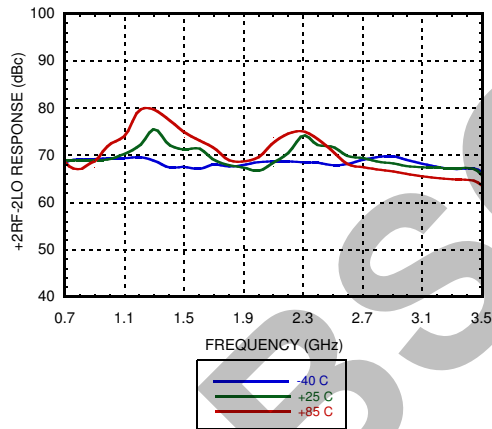

**+3RF -3LO Response vs. Temperature
@ VGATE=4.8V**

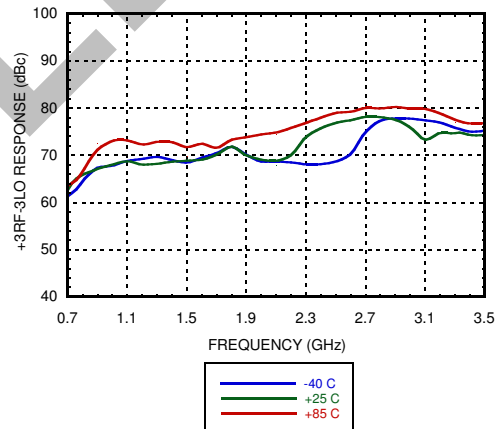

**Noise Figure vs. Temperature
@ VGATE=4.8V**

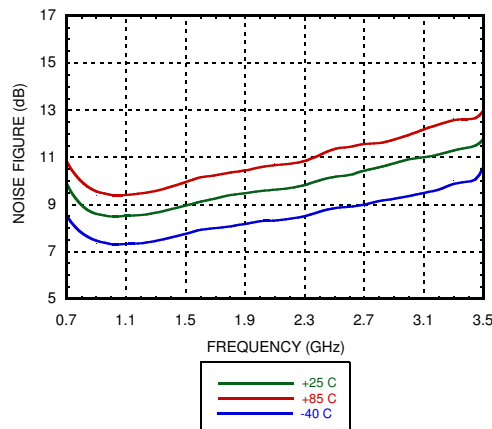

All plots are for Low Side LO injection unless otherwise noted. Balun losses at IF output ports are de-embedded.

Information furnished by Analog Devices is believed to be accurate and reliable. However, no responsibility is assumed by Analog Devices for its use, nor for any infringements of patents or other rights of third parties that may result from its use. Specifications subject to change without notice. No license is granted by implication or otherwise under any patent or patent rights of Analog Devices. Trademarks and registered trademarks are the property of their respective owners.

For price, delivery, and to place orders: Analog Devices, Inc., One Technology Way, P.O. Box 9106, Norwood, MA 02062-9106 Phone: 781-329-4700 • Order online at www.analog.com Application Support: Phone: 1-800-ANALOG-D



**BROADBAND HIGH IP3 DUAL CHANNEL DOWNCONVERTER,
0.7 - 3.5 GHz**

MIXERS - SMT

**Conversion Gain vs. Temperature
@ VGATE=4.7V**

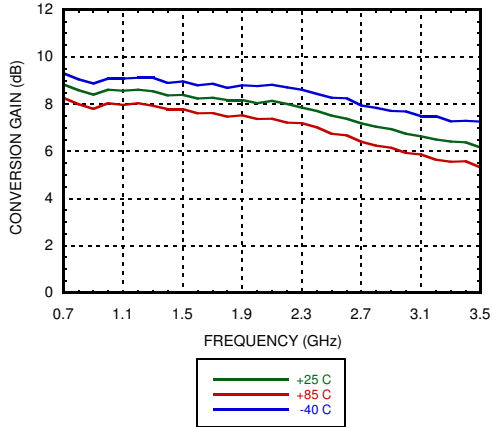

**Input IP3 vs. Temperature
@ VGATE=4.7V**

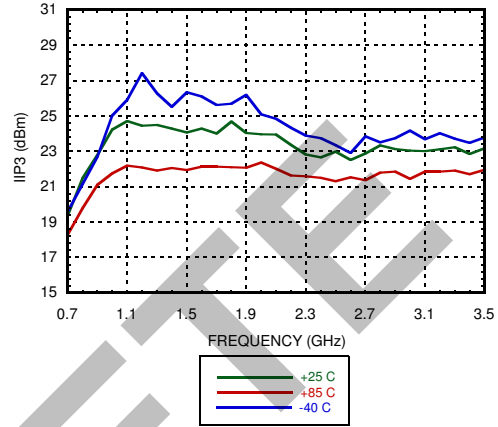

**+2RF -2LO Response vs. Temperature
@ VGATE=4.7V**

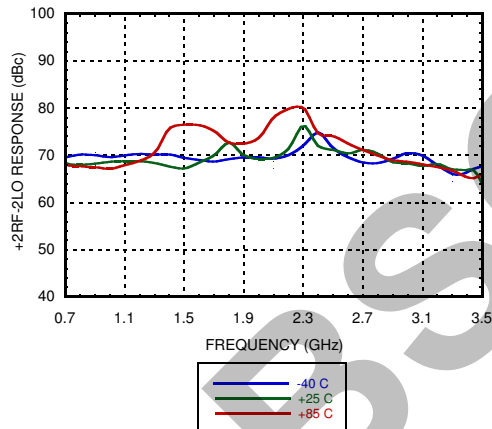

**+3RF -3LO Response vs. Temperature
@ VGATE=4.7V**

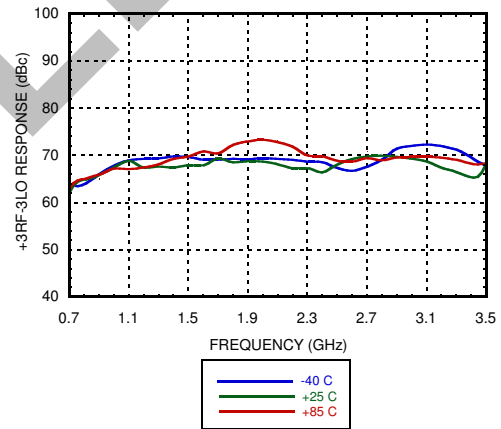

**Noise Figure vs. Temperature
@ VGATE=4.7V**

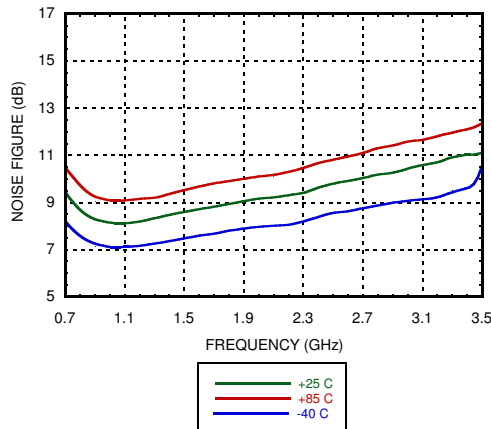

All plots are for Low Side LO injection unless otherwise noted. Balun losses at IF output ports are de-embedded.

Information furnished by Analog Devices is believed to be accurate and reliable. However, no responsibility is assumed by Analog Devices for its use, nor for any infringements of patents or other rights of third parties that may result from its use. Specifications subject to change without notice. No license is granted by implication or otherwise under any patent or patent rights of Analog Devices. Trademarks and registered trademarks are the property of their respective owners.

For price, delivery, and to place orders: Analog Devices, Inc., One Technology Way, P.O. Box 9106, Norwood, MA 02062-9106 Phone: 781-329-4700 • Order online at www.analog.com Application Support: Phone: 1-800-ANALOG-D



BROADBAND HIGH IP3 DUAL CHANNEL DOWNCONVERTER, 0.7 - 3.5 GHz

Channel to Channel Isolation vs. VGATE

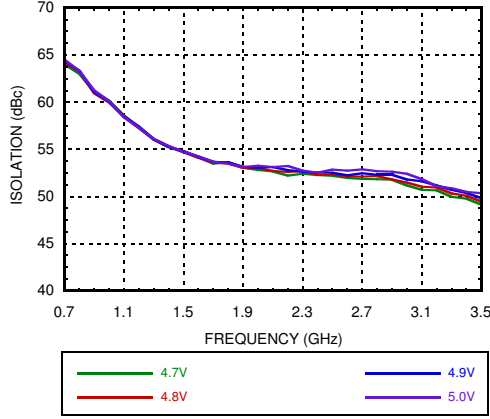

Channel to Channel Isolation vs. IF Frequency

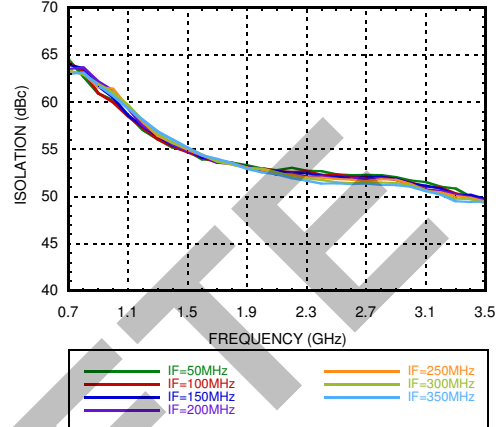

Conversion Gain, Channel Matching @ VGATE=4.8V

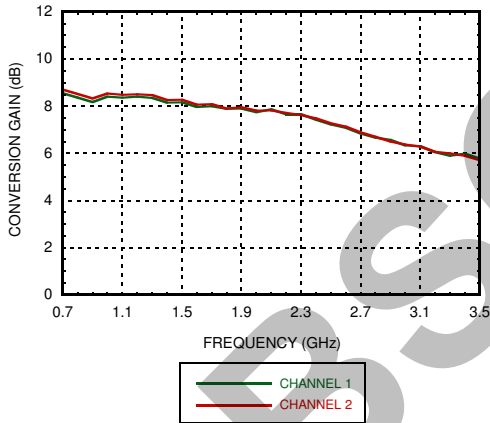

Input IP3, Channel Matching @ VGATE=4.8V

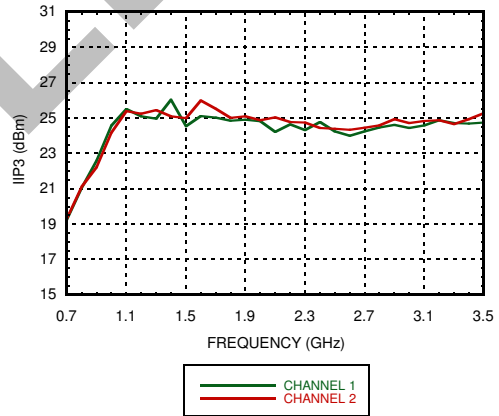

Conversion Gain vs. Vdd @ VGATE=4.8V

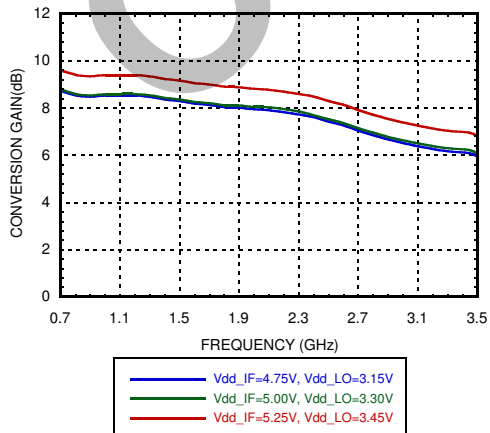

Input IP3 vs. Vdd @ VGATE=4.8V

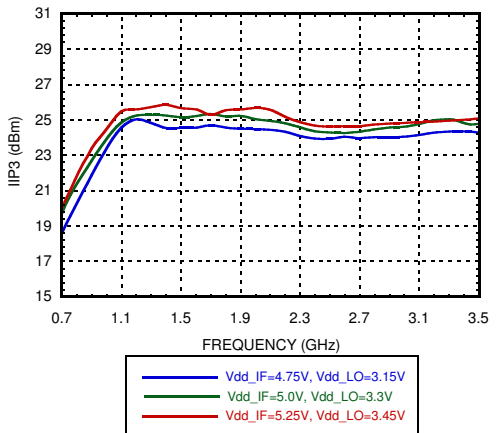

All plots are for Low Side LO injection unless otherwise noted. Balun losses at IF output ports are de-embedded.

Information furnished by Analog Devices is believed to be accurate and reliable. However, no responsibility is assumed by Analog Devices for its use, nor for any infringements of patents or other rights of third parties that may result from its use. Specifications subject to change without notice. No license is granted by implication or otherwise under any patent or patent rights of Analog Devices. Trademarks and registered trademarks are the property of their respective owners.

For price, delivery, and to place orders: Analog Devices, Inc., One Technology Way, P.O. Box 9106, Norwood, MA 02062-9106 Phone: 781-329-4700 • Order online at www.analog.com Application Support: Phone: 1-800-ANALOG-D



**BROADBAND HIGH IP3 DUAL CHANNEL DOWNCONVERTER,
0.7 - 3.5 GHz**

Conversion Gain vs. IF Frequency
@ LO=850 MHz, VGATE=4.8V

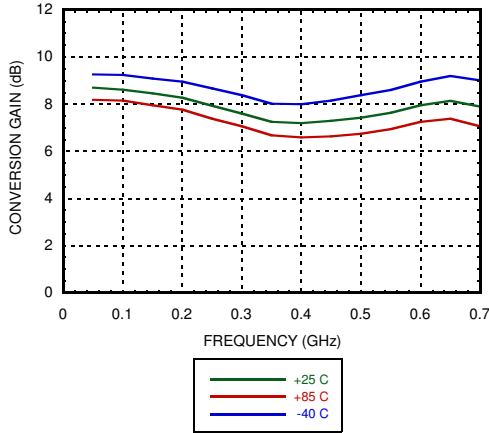

IIP3 vs. IF Frequency
@ LO=850 MHz, VGATE=4.8V

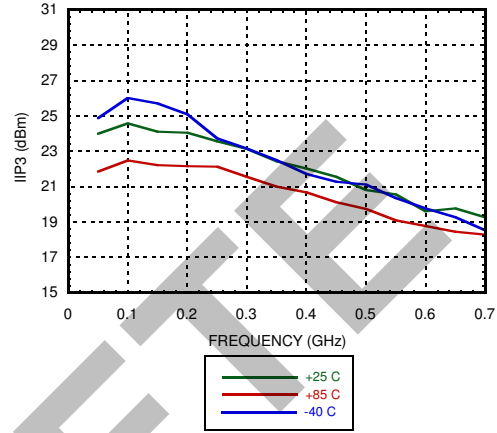

Conversion Gain vs. IF Frequency
@ LO=1800 MHz, VGATE=4.8V

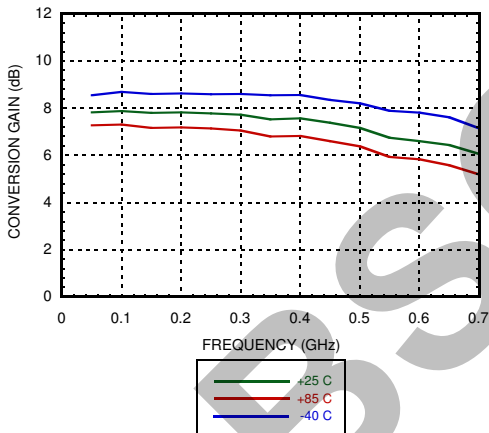

IIP3 vs. IF Frequency
@ LO=1800 MHz, VGATE=4.8V

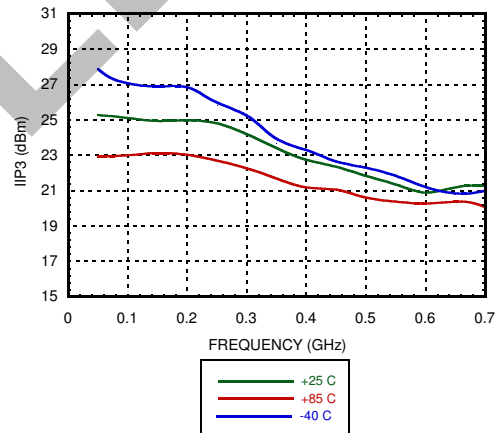

All plots are for Low Side LO injection unless otherwise noted. Balun losses at IF output ports are de-embedded.

Information furnished by Analog Devices is believed to be accurate and reliable. However, no responsibility is assumed by Analog Devices for its use, nor for any infringements of patents or other rights of third parties that may result from its use. Specifications subject to change without notice. No license is granted by implication or otherwise under any patent or patent rights of Analog Devices. Trademarks and registered trademarks are the property of their respective owners.

For price, delivery, and to place orders: Analog Devices, Inc., One Technology Way, P.O. Box 9106, Norwood, MA 02062-9106 Phone: 781-329-4700 • Order online at www.analog.com Application Support: Phone: 1-800-ANALOG-D



Harmonics of LO

LO Freq. (GHz)	nLO Spur @ RF Port			
	1	2	3	4
0.7	-55	-48	-65	-64
1.1	-53	-50	-65	-54
1.5	-53	-52	-66	-54
1.9	-53	-49	-70	-64
2.3	-54	-48	-68	-51
2.7	-72	-46	-59	-48
3.1	-54	-51	-73	-48
3.5	-59	-63	-59	-46

LO = 0dBm
All values in dBm measured at RF port.

BROADBAND HIGH IP3 DUAL CHANNEL DOWNCONVERTER, 0.7 - 3.5 GHz

MxN Spurious @ IF Port

mRF	nLO				
	0	1	2	3	4
0	xx	-39	-56	-50	-46
1	-44	0	-40	-19	-50
2	-66	-53	-60	-58	-76
3	-100	-59	-92	-66	-100
4	-113	-107	-112	-109	-110

RF Freq. = 0.9 GHz @ -5 dBm
LO Freq. = 0.8 GHz @ 0 dBm
All values in dBc below IF power level (1RF - 1LO).

MxN Spurious @ IF Port

mRF	nLO				
	0	1	2	3	4
0	xx	-38	-37	-60	-49
1	-50	0	-44	-35	-73
2	-70	-56	-66	-64	-84
3	-114	-75	-97	-66	-108
4	-123	-132	-125	-111	-117

RF Freq. = 1.9 GHz @ -5 dBm
LO Freq. = 1.8 GHz @ 0 dBm
All values in dBc below IF power level (1RF - 1LO).

MxN Spurious @ IF Port

mRF	nLO				
	0	1	2	3	4
0	xx	-38	-39	-63	-45
1	-54	0	-45	-45	-71
2	-70	-81	-68	-78	-94
3	-121	-87	-102	-69	-100
4	-123	-138	-123	-142	-117

RF Freq. = 2.5 GHz @ -5 dBm
LO Freq. = 2.4 GHz @ 0 dBm
All values in dBc below IF power level (1RF - 1LO).

Typical Supply Current vs. Vdd

VDD_IF VDD_IF1 VDD_IF2 (V)	I _{dd_IF} (mA)	VDD_LO1, VDD_LO2 (V)	I _{dd_LO} (mA)
4.75	162	3.15	177
5.00	180	3.30	170
5.25	198	3.45	181

Truth Table

IFA1_EN (V)	IFAMP1	IFA2_EN (V)	IFAMP2	LO_EN (V)	LO_STAGES
Low	ON	Low	ON	Low	ON
High	OFF	High	OFF	High	OFF



BROADBAND HIGH IP3 DUAL CHANNEL DOWNCONVERTER, 0.7 - 3.5 GHz

Absolute Maximum Ratings

RF Input Power (VDD_IF= +5V, VDD_LO1,2=3.3V)	+20 dBm
LO Input Power (VDD_IF= +5V, VDD_LO1,2=3.3V)	+20 dBm
VDD_IF, VDD_LO1,2	6V
VGATE1,2	5.5V
Max. Channel Temperature	175°C
Continuous P _{diss} (T = 85°C) (derate 77.63 mW/°C above 85°C)	5.05 W
Thermal Resistance (channel to ground paddle)	12.8 °C/W
Storage Temperature	-65 to 150°C
Operating Temperature	-40 to +85 °C
ESD Sensitivity (HBM)	Class 1B

Recommended Operating Conditions

Parameter	Min.	Typ.	Max.	Units
Temperature				
Junction Temperature			150	°C
Ambient Temperature	-40		85	°C



**ELECTROSTATIC SENSITIVE DEVICE
OBSERVE HANDLING PRECAUTIONS**

Outline Drawing

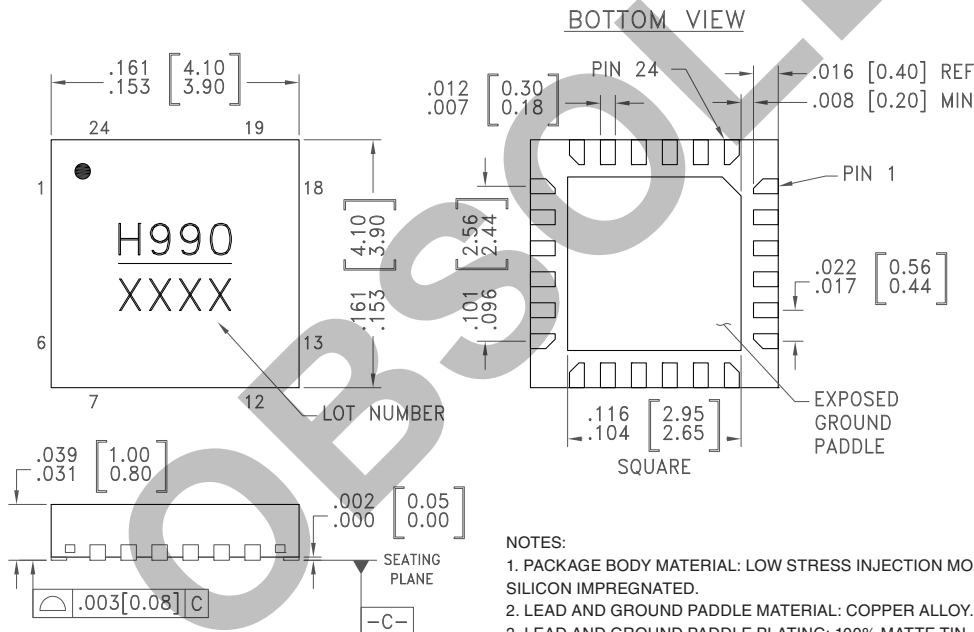

NOTES:

1. PACKAGE BODY MATERIAL: LOW STRESS INJECTION MOLDED PLASTIC SILICA AND SILICON IMPREGNATED.
2. LEAD AND GROUND PADDLE MATERIAL: COPPER ALLOY.
3. LEAD AND GROUND PADDLE PLATING: 100% MATTE TIN
4. DIMENSIONS ARE IN INCHES [MILLIMETERS].
5. LEAD SPACING TOLERANCE IS NON-CUMULATIVE.
6. CHARACTERS TO BE HELVETICA MEDIUM, .025 HIGH, WHITE INK, OR LASER MARK LOCATED APPROX. AS SHOWN.
7. PAD BURR LENGTH SHALL BE 0.15mm MAX. PAD BURR HEIGHT SHALL BE 0.05mm MAX.
8. PACKAGE WARP SHALL NOT EXCEED 0.05mm
9. ALL GROUND LEADS AND GROUND PADDLE MUST BE SOLDERED TO PCB RF GROUND.
10. REFER TO HITTITE APPLICATION NOTE FOR SUGGESTED PCB LAND PATTERN.

Package Information

Part Number	Package Body Material	Lead Finish	MSL Rating	Package Marking
HMC990LP4E	RoHS-compliant Low Stress Injection Molded Plastic	100% matte Sn	MSL1 ^[1]	H990 XXX

[1] Max peak reflow temperature of 260 °C

[2] 4-Digit lot number XXXX





BROADBAND HIGH IP3 DUAL CHANNEL DOWNCONVERTER, 0.7 - 3.5 GHz

Pin Descriptions

Pin Number	Function	Description	Interface Schematic
1, 6	RF1, RF2	RF input pins of the mixer, internally matched to 50 Ohms. RF input pins require off-chip DC blocking capacitors. See application circuit.	
2,5	N/C	Not connected internally.	
3,4	VDD_LO1, VDD_LO2	3.3V bias supply for LO Drive stages. Refer to application circuit for appropriate filtering.	
7	VGATE2	Bias pins for mixer cores. Set from 4.7V to 5.0V for operating frequency band.	
24	VGATE1		
8	VDD_IF2	Supply voltage pins for IF amplifiers' bias circuits. Connect to 5V supply through filtering.	
23	VDD_IF1		
9	IF2_P	Differential IF outputs. Connect to 5V supply through choke inductors. See application circuit.	
10	IF2_N		
21	IF1_N		
22	IF1_P		
11,20	VCS2,VCS1	Bias control pins for IF amplifiers. Connect to 5V supply through 130 Ohms resistors. Refer to application section for proper values of resistors to adjust IF amplifier current.	

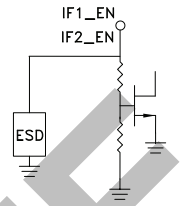
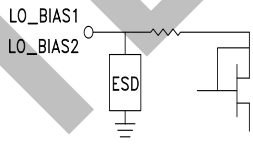

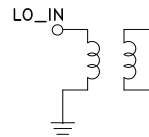
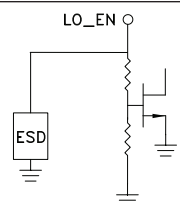
**BROADBAND HIGH IP3 DUAL CHANNEL DOWNCONVERTER,
0.7 - 3.5 GHz**
Pin Descriptions (continued)

Pin Number	Function	Description	Interface Schematic
12,19	IFA2_EN, IFA1_EN	Enable pins for IF Amplifiers. When connected to LOW or left unconnected, amplifiers are enabled. For disable mode connect to HIGH.	
13,14	LO_BIAS2, LO_BIAS1	Bias control pins for LO Amplifiers. Connect to 5V supply through 150 Ohms resistors. Refer to application section for proper values of resistors to adjust LO amplifier current.	
15,17	GND	Connect to RF and DC ground.	
16	LO_IN	LO input of the mixer. Internally matched to 50 Ohms. Requires off-chip DC blocking capacitor. See application circuit.	
18	LO_EN	Enable for LO Amplifiers. When connected to LOW or left unconnected, amplifiers are enabled. For disable mode connect to HIGH.	

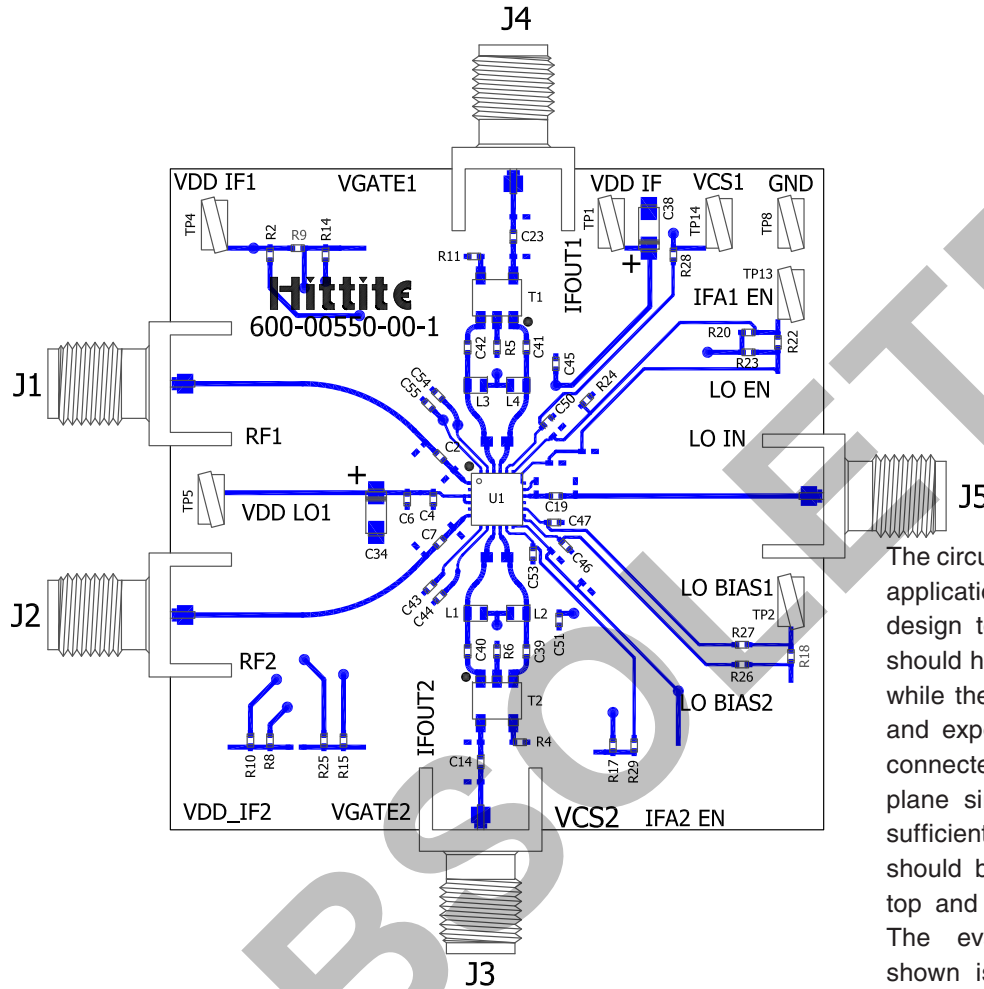

BROADBAND HIGH IP3 DUAL CHANNEL DOWNCONVERTER, 0.7 - 3.5 GHz

Evaluation PCB



The circuit board used in the final application should use RF circuit design techniques. Signal lines should have 50 Ohm impedance while the package ground leads and exposed paddle should be connected directly to the ground plane similar to that shown. A sufficient number of via holes should be used to connect the top and bottom ground planes. The evaluation circuit board shown is available from Hittite upon request.

List of Materials for Evaluation PCB EVAL01- HMC990LP4E [1]

Item	Description
J1 - J5	PCB Mount SMA Connector
TP1,TP2,TP4,TP5,TP8,TP13,TP14	Test Point
L1-L4	680 nH Inductor, 0603 Pkg.
C45-C47,C50-C51,C53-C55	0.01 µF Capacitor, 0603 Pkg
C34,C38	4.7 µF CaSE A, Tantalum
C4	100 pF Capacitor, 0402 Pkg.
C2,C7,C19	1 nF Capacitor, 0402 Pkg.
C6,C14,C23,C39-C44	10 nF Capacitor, 0402 Pkg.
R2,R4-R6,R8,R9-R11,R14-R15,R17-R18,R20,R22,R23,R25	0 ohm Resistor, 0402 Pkg.
R24	100 Kohm Resistor, 0402 Pkg.
R26-R27	150 ohm Resistor, 0402 Pkg.
R28-R29	130 ohm Resistor, 0402 Pkg.
T1-T2	1:4 Transformer - ETC4-1T-7TR.

[1] Reference this number when ordering complete evaluation PCB

Information furnished by Analog Devices is believed to be accurate and reliable. However, no responsibility is assumed by Analog Devices for its use, nor for any infringements of patents or other rights of third parties that may result from its use. Specifications subject to change without notice. No license is granted by implication or otherwise under any patent or patent rights of Analog Devices. Trademarks and registered trademarks are the property of their respective owners.

For price, delivery, and to place orders: Analog Devices, Inc., One Technology Way, P.O. Box 9106, Norwood, MA 02062-9106 Phone: 781-329-4700 • Order online at www.analog.com Application Support: Phone: 1-800-ANALOG-D



**BROADBAND HIGH IP3 DUAL CHANNEL DOWNCONVERTER,
0.7 - 3.5 GHz**

Application Circuit - Broadband

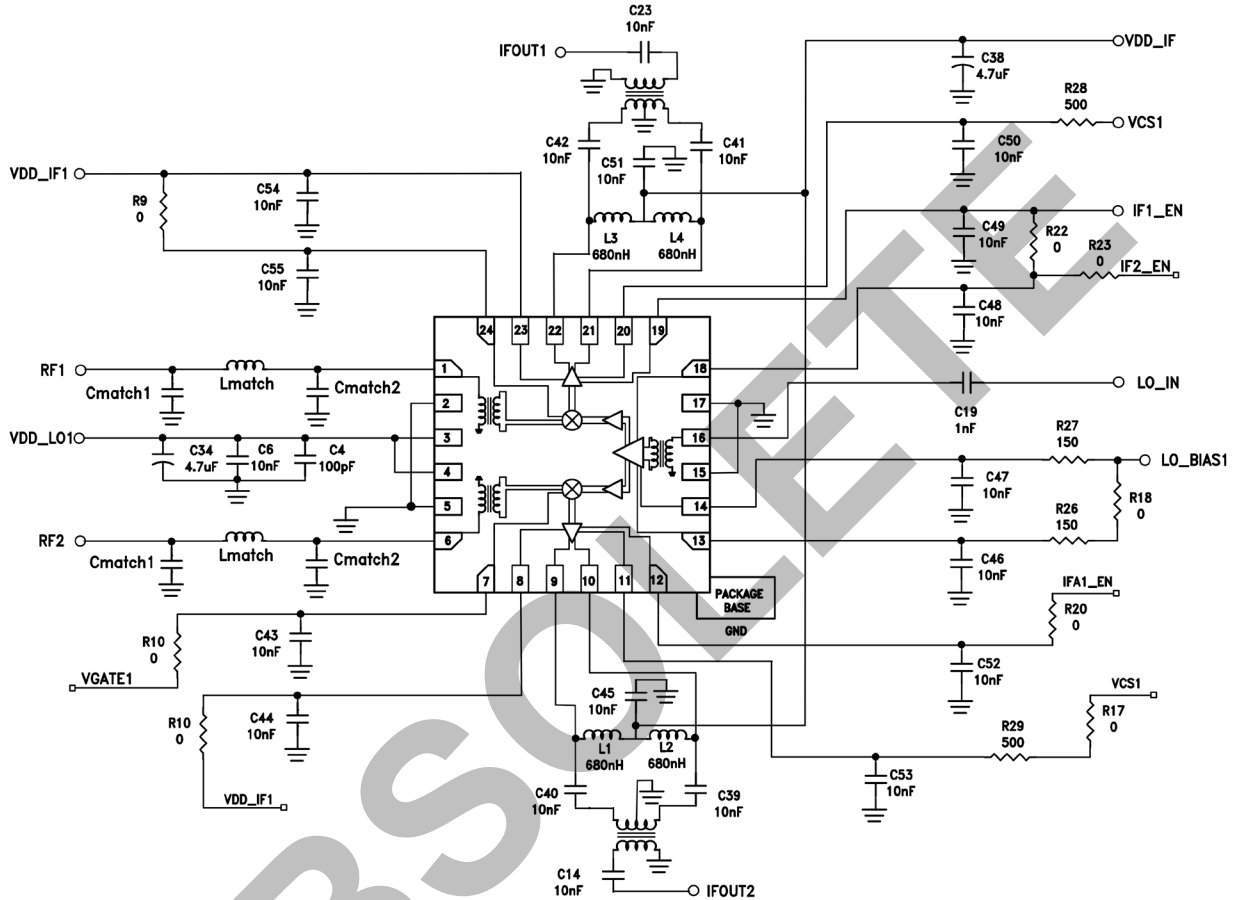

Notes:

- 1-Differential IF output transmission lines should be symmetrical
- 2-Refer to evaluation PCB for component placements and distances

**BROADBAND HIGH IP3 DUAL CHANNEL DOWNCONVERTER,
0.7 - 3.5 GHz****Application Information**

The HMC990LP4E is a broadband dual channel, high dynamic range, high gain, low noise, high-linearity downconverting mixer designed for covering RF frequencies from 700 MHz to 3.5 GHz. The HMC990LP4E's low noise and high linearity performance makes it suitable for a wide range of transmission standards, including LTE, CDMA, GSM, MC-GSM, W-CDMA, UMTS, TD-SCDMA, WiMAX applications.

The HMC990LP4E offers an easy-to-use and complete frequency conversion solution for diversity and MIMO receiver applications in a highly compact 4x4 mm² QFN package. The HMC990LP4E greatly simplifies the design of diversity and MIMO receiver applications by increasing the integration level and reducing the number of required circuit elements thereby reducing cost, area, and power consumption.

Principle of Operation

The HMC990LP4E has two identical, symmetrical double-balanced passive mixers. These mixers are driven from a common single-ended LO input that is broadband matched to 50 Ω and requires only a standard DC-blocking capacitor. The single-ended LO input is converted into differential through the on-chip integrated balun followed by a LO driver stage. The differential signal is divided into two differential paths and each mixer is driven by a separate LO amplifier.

The HMC990LP4E's single-ended RF inputs are converted into differential through the on-chip integrated baluns. The single-ended RF inputs are internally broadband matched to 50 Ω and require only standard DC-blocking capacitors. However, the HMC990LP4E's RF inputs can be externally matched for narrow band application frequency with a simple matching network including a series inductor and a shunt capacitor to further improve the performance. Please refer to the application circuit for narrowband RF input matching for the detailed information.

The HMC990LP4E's IF amplifiers are designed for differential 200 Ω output impedance. A few external components are required at these IF outputs for the broadband frequency response as recommended in the application circuit. Please refer to the IF output interface section for more information.

The HMC990LP4E requires 5V and 3.3V supply voltages and external bias voltages. Bias voltages generate reference currents for the IF and LO amplifiers. 3.3V supply voltage and the external bias voltages can be generated from 5V supply voltage to operate with a single supply. Please refer to the single supply operation section for more information.

The reference currents to the LO amplifiers and IF amplifiers can be disabled through LO_EN and IFA1_EN, IFA2_EN pins respectively. If the EN pins are connected to LOW or left unconnected, the part operates normally. If the EN pins are connected to HIGH, the LO amplifiers and IF amplifiers are disabled.

Single Supply Operation

The HMC990LP4E requires 5V and 3.3V supply voltages and the external bias voltages. The external bias voltages except VGATE1, VGATE2 pin voltages are already generated from 5V supply voltage on evaluation board (see application circuit). These bias voltages can be optimized by series resistances with appropriate values from the 5V supply to the bias pins (VCS1, VCS2, LO_BIAS1, LO_BIAS2). The resistor values on VCS1, VCS2 and LO_BIAS1, LO_BIAS2 traces on evaluation board are 130 Ohms and 150 Ohms respectively. Refer to the VCS Interface and LO_BIAS Interface section for more information.

The nominal VGATE1, VGATE2 pin voltages are 4.8V that is applied externally. However VGATE1, VGATE2 pin voltages can be tuned between 4.7V and 5V for optimization of Input IP3 and conversion gain performances. After VGATE1, VGATE2 pin voltages are optimized, these pin voltages can be generated from 5V supply by changing the values of series resistors, R14 and R15. Refer to the VGATE interface section for more information.



BROADBAND HIGH IP3 DUAL CHANNEL DOWNCONVERTER, 0.7 - 3.5 GHz

The 3.3V supply voltage for the LO amplifiers can be generated from 5V supply voltage by adding 20 Ohms resistors between VDD_LO1, VDD_LO2 pins and 5V supply voltage. VDD_LO1 and VDD_LO2 pins are shorted and connected to VDD_LO1 test point on evaluation board, hence a 10 Ohms resistor (Rvdd_lo) can be added in series with VDD_LO1 test point as shown in Figure 1. The resistor must have a power rating of 1/2W or more.

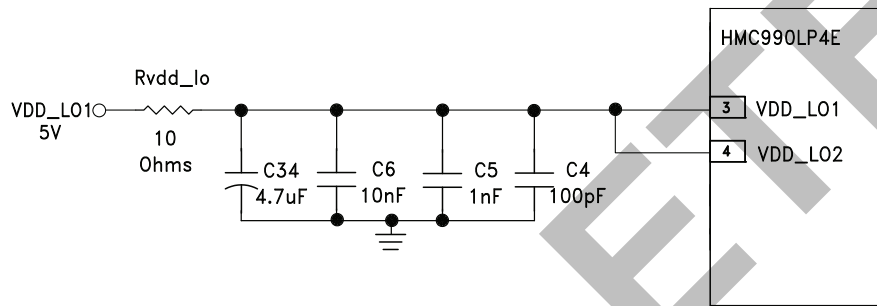

Figure 1. Interface to generate 3.3V for VDD_LO1 and VDD_LO2 pins from 5V Supply.

VGATE Interface

The VGATE1, VGATE2 pins are bias pins for mixer cores. The nominal VGATE1, VGATE2 pin voltages are 4.8V that is applied externally. However voltage can be tuned between 4.7V and 5V for optimizing input IP3 and conversion gain performances for desired frequency band. Higher IIP3 values can be obtained by increasing the VGATE1, VGATE2 pin voltages but this will reduce mixer's conversion gain. Figure-2 shows the measured conversion gain and IIP3 for four values of the VGATE1, VGATE2 pin voltages.

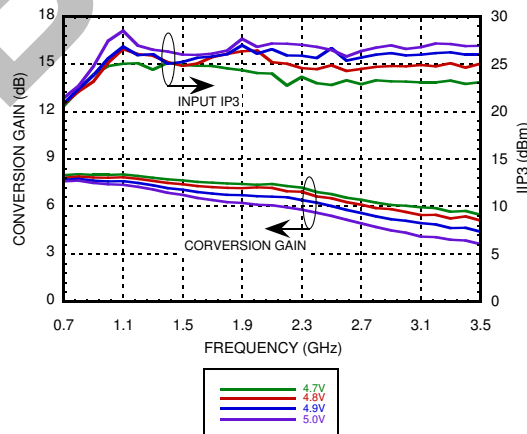

Figure-2. Conversion Gain & IIP3 vs. RF Frequency over VGATE Pin Voltage @25C, IF =100 MHz [1]

[1] Balun losses at IF output ports are de-embedded.

Information furnished by Analog Devices is believed to be accurate and reliable. However, no responsibility is assumed by Analog Devices for its use, nor for any infringements of patents or other rights of third parties that may result from its use. Specifications subject to change without notice. No license is granted by implication or otherwise under any patent or patent rights of Analog Devices. Trademarks and registered trademarks are the property of their respective owners.

For price, delivery, and to place orders: Analog Devices, Inc., One Technology Way, P.O. Box 9106, Norwood, MA 02062-9106 Phone: 781-329-4700 • Order online at www.analog.com Application Support: Phone: 1-800-ANALOG-D



BROADBAND HIGH IP3 DUAL CHANNEL DOWNCONVERTER, 0.7 - 3.5 GHz

After the VGATE voltage is tuned for optimized IIP3 and conversion gain performance, the VGATE pin voltage can be generated from 5V supply voltage by changing the value of series resistors, R14 and R15 from 0 Ohm to an appropriate value.

Table-1 shows the typical resistor values that need to be added in series with VGATE1, VGATE2 pins for different VGATE voltages. A fine tune for R14 and R15 resistors can be needed if a better fit is required.

Table-1: Resistor values for different VGATE pin voltages

Vgate1=Vgate2	R14=R15
4.7V	174 Ohm
4.8V	120 Ohm
4.9V	56 Ohm
5.0V	0 Ohm

VCS Interface and LO_BIAS Interface

The VCS1, VCS2 pins are bias pins for IF amplifiers on each channel and set the reference currents to these IF amplifiers. The VCS voltage is generated from the 5V supply by series resistances. Higher IIP3 values can be obtained by reducing the values of these series resistances R28 and R29, which will increase the total supply current of the IF amplifiers. Figure-3a shows the measured conversion gain and IIP3 vs. total supply current from the VDD_IF1, VDD_IF2 and VDD_IF test points at 1900MHz.

The LO_BIAS1, LO_BIAS2 pins are bias pins for LO amplifiers and set the reference currents to these LO amplifiers. The LO_BIAS voltage is generated from the 5V supply by series resistances R26 and R27. Figure-3b shows the measured conversion gain and IIP3 vs. total supply current from the VDD_LO1 test point at 1900MHz.

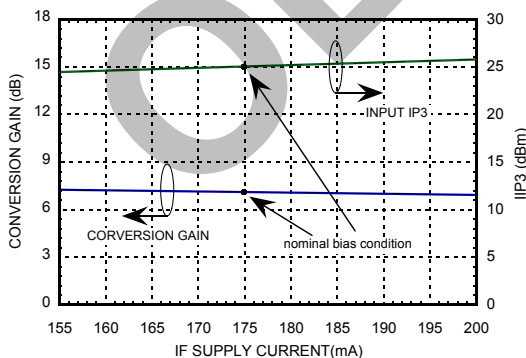

Figure 3a. IIP3 and conversion gain vs. IF stage's Total supply current
@25C, RF=1900MHz, IF= 100MHz , VGATE=4.8V [1]

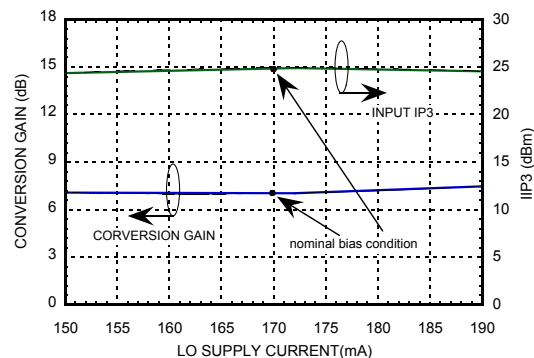

Figure 3b. IIP3 and conversion gain vs. LO stage's Total supply current
@25C, RF=1900MHz, IF= 100MHz , VGATE=4.8V [1]

[1] Balun losses at IF output ports are de-embedded.



BROADBAND HIGH IP3 DUAL CHANNEL DOWNCONVERTER, 0.7 - 3.5 GHz

Table-2 and Table-3 show the typical resistor values that are used in series with VCS1, VCS2 and LO_BIAS1, LO_BIAS2 pins for different total supply current values of IF and LO stages. A fine tune for these resistors can be needed if a better fit is required.

Table-2: Resistor values for total supply current of IF Amplifiers

IF Amplifiers Total Supply Current	R28=R29
155mA	820 Ohm
180mA	590 Ohm
200mA	390 Ohm

Table-3: Resistor values for total supply current of LO Amplifier

LO Amplifier Total Supply Current	R26=R27
150mA	620 Ohm
170mA	270 Ohm
190mA	0 Ohm

External RF Matching

The HMC990LP4E's RF inputs are internally broadband matched to 50Ω. RF inputs can be externally matched for a specific RF frequency band of interest to further improve Input IP3 (IIP3). Matching RF inputs to a specific RF frequency band can be easily accomplished by adding a series inductor and a shunt capacitor. See Table-4 for values of the external matching components for corresponding RF frequency bands. Figure-4 shows the application circuit with the external components on RF input pins.

LO_BIAS2 and VGATE1, VGATE2 pin voltages can be optimized for a specific RF frequency band by changing the resistor values in series with these pins. Table-1 shows the resistor values (R14, R15) for corresponding VGATE pin voltage. Table-4 shows the resistor value (R26) for recommended LO_BIAS2 pin voltage.

Figure-5 shows the measured conversion gain and IIP3 for 900MHz,1900MHz and 2500MHz RF frequency bands.

Table-4: Components for Selected Frequency Bands

Tune Option	Lmatch	Cmatch1,	Cmatch2	R26	Recommended VGATE1,2 Voltages
900 MHz	6.8nH	2.7pF	Open	150 Ohms	5.0V
1900 MHz	2.7nH	1pF	Open	270 Ohms	4.8V
2500MHz	1nH	Open	1pF	270 Ohms	4.8V

BROADBAND HIGH IP3 DUAL CHANNEL DOWNCONVERTER, 0.7 - 3.5 GHz

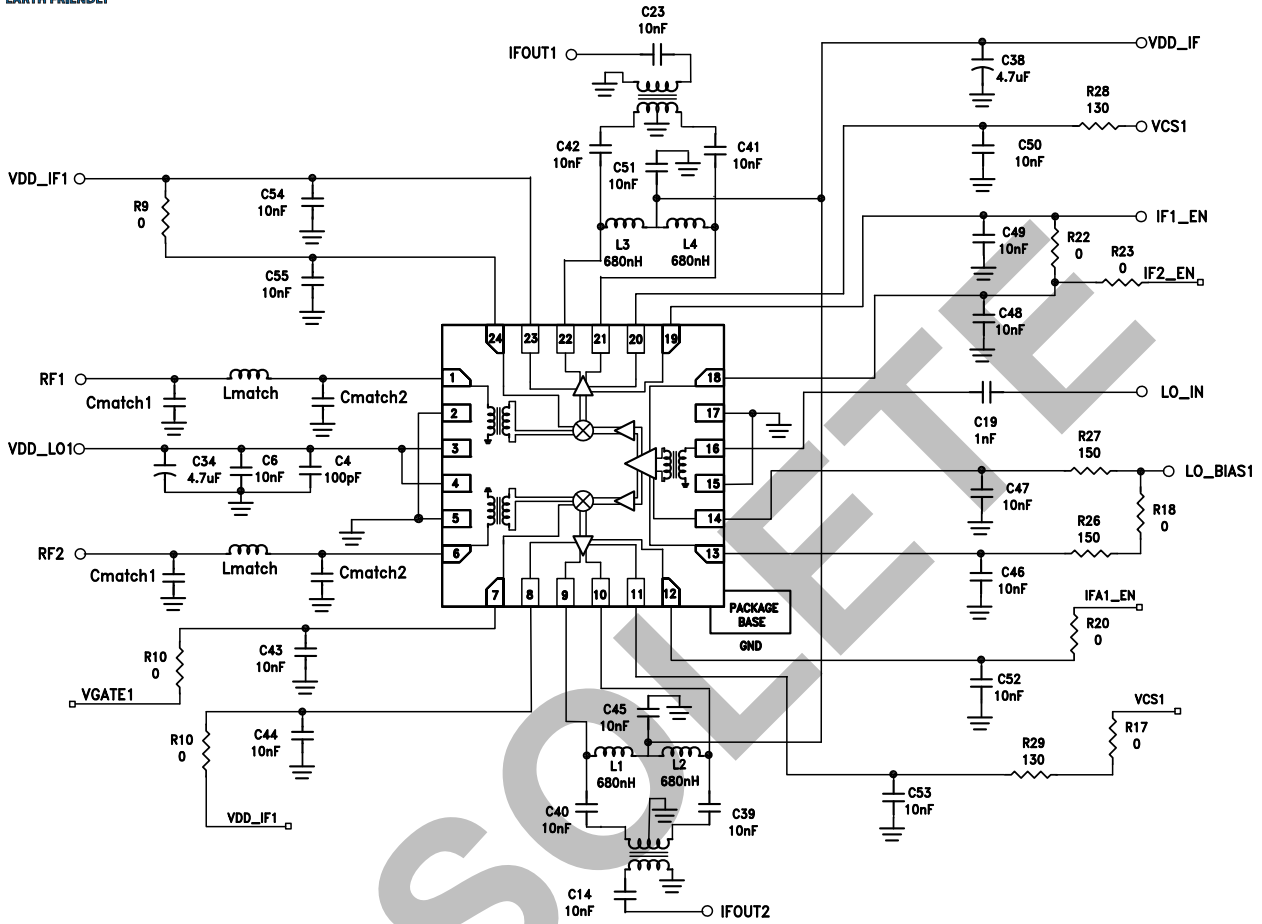

Figure-4. Application Circuit for Narrowband RF Input Matching

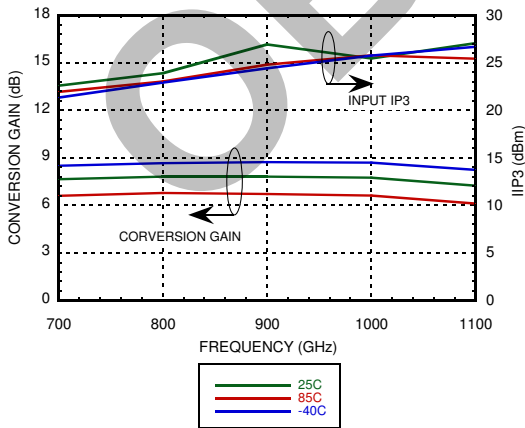

Figure-5a. IIP3 and Conversion Gain with matching for 900 MHz band

VGATE=5.0 V, IF=100 MHz [1]

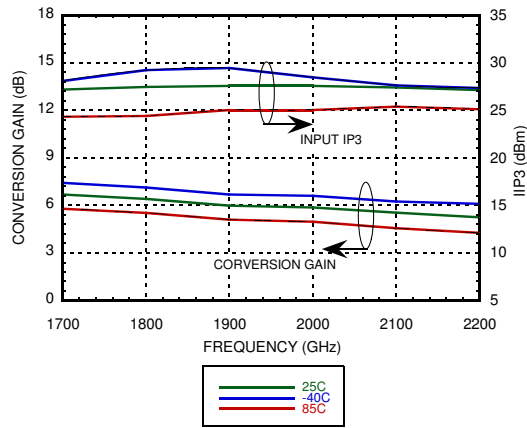

Figure-5b. IIP3 and Conversion Gain with matching for 1900 MHz band

VGATE=4.8 V, IF=100 MHz [1]

[1] Balun losses at IF output ports are de-embedded.



**BROADBAND HIGH IP3 DUAL CHANNEL DOWNCONVERTER,
0.7 - 3.5 GHz**

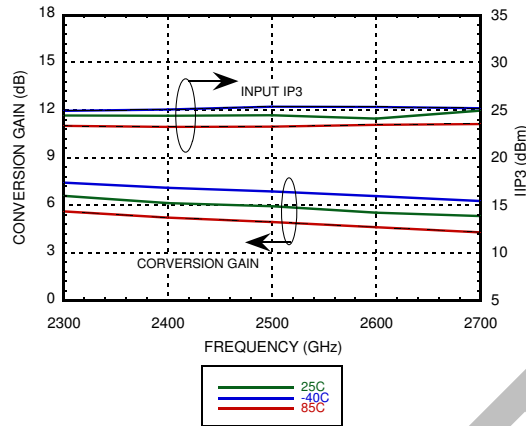

Figure-5c. IIP3 and Conversion Gain with matching for 2500 MHz band VGATE=4.8 V, IF=100 MHz ^[1]

It is recommended to use high side LO injection for RF frequencies below 1GHz for better IIP3. For instance, higher IIP3 can be obtained if LO input is driven with high side at RF=900 MHz. Please refer to Figure-6.

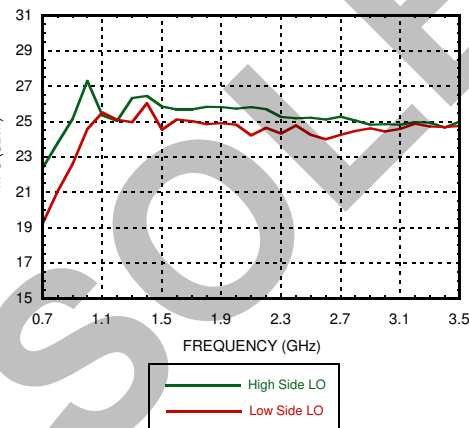

Figure-6. Input IP3 vs. High Side LO & Low Side LO @ VGATE=4.8V

Input IP3 Dependence on RF Input Power

The HMC990LP4E accepts a wide range of RF input power. Figure-7 shows the IIP3 vs. RF input power for 1900 MHz RF and 150 MHz IF.

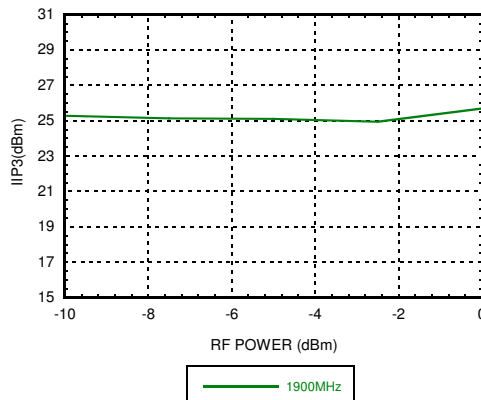

Figure-7. IIP3 vs. RF Input Power, RF=1900MHz, IF=150MHz, VGATE=4.8V

[1] Balun losses at IF output ports are de-embedded.



**BROADBAND HIGH IP3 DUAL CHANNEL DOWNCONVERTER,
0.7 - 3.5 GHz**

IF Output Interface

The HMC990LP4E's differential IF output pins are biased at the 5V supply voltage through choke inductors as shown in the application circuit. The default values of these choke inductors are 680nH. Figure-8 shows the measured conversion gain vs. IF frequency where 1-dB IF bandwidth is around 470MHz and 3-dB IF bandwidth is above 700MHz. Higher IF bandwidth values can be obtained by reducing the value of the choke inductors.

The baluns at the IF outputs are used to convert the 200 Ohms differential output impedance of HMC990LP4E to single-ended 50 Ohms for characterization.

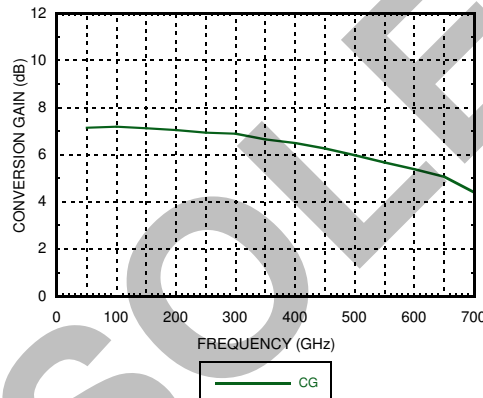

Figure-8. Conversion gain vs. IF Frequency @ LO=1.5GHz ^[1]

[1] Balun losses at IF output ports are de-embedded.

Looking for pricing, stock, or lifecycle information?

Click below to explore more details on WIN SOURCE:

 [View HMC990LP4ETR on WIN SOURCE](#)

 [Analog Devices Inc. Information](#)

Optimize Your Supply Chain with WIN SOURCE Solutions

-  Global Sourcing Solution
-  Obsolete Management
-  Cost Control Management
-  Shortage Management
-  Alternative Solution
-  Excess Inventory Management