



THE DATASHEET OF HMC915LP4ETR



Typical Applications

The HMC915LP4E is ideal for:

- PCS / 3G Infrastructure
- Base Stations & Repeaters
- WiMAX & WiBro
- ISM & Fixed Wireless

Features

- Input IP3: +28 dBm
- Low Input LO Drive: -2 to +4 dBm
- High LO to RF Isolation: 28 dB
- Low Conversion Loss: 8 dB
- Single Positive Supply: +5V @ 88 mA
- 24 Lead 4x4mm SMT Package: 16mm²

Functional Diagram

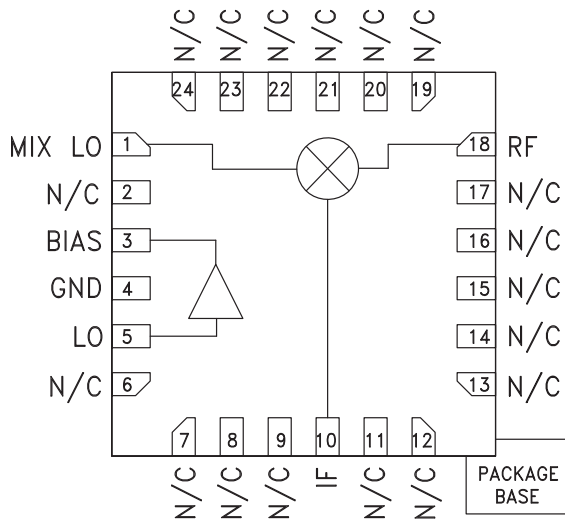

General Description

The HMC915LP4E is a high linearity, double-balanced converter that operates from 0.5 to 2.7 GHz and delivers a +28 dBm input IP3. The LO amplifier output and high dynamic range mixer input are positioned so that an external LO filter can be placed in series between them if necessary. The converter provides 28 dB of LO to RF isolation and is ideal for upconverter and downconverter applications. The IC operates from a single +5V supply consuming 88 mA and accepts LO drive levels of -2 to +4 dBm. The design requires no external baluns and supports IF frequencies between DC and 1 GHz. The HMC915LP4E is pin for pin compatible with the HMC552LP4E and the HMC215LP4E mixers with integrated LO amplifiers.

Electrical Specifications, $T_A = +25^\circ\text{C}$, LO = +2 dBm, Vcc = +5V, IF = 100 MHz*

Parameter	Min.	Typ.	Max.	Min.	Typ.	Max.	Units
Frequency Range, RF, LO	0.5 - 2.0			2.0 - 2.7			GHz
Frequency Range, IF	DC - 1.0			DC - 1.0			GHz
Conversion Loss		8	11		10	13	dB
Noise Figure (SSB)		8.5			10.5		dB
LO to RF Isolation	22	30		25	28		dB
LO to IF Isolation	10	16		12	18		dB
IP3 (Input)		28			28		dBm
1 dB Compression (Input)		18			20		dBm
LO Drive Input Level (Typical)	-2 to 4			+2 to 6			dBm
Supply Current (Icc)	78	88	110	78	88	110	mA

*Unless otherwise noted, all measurements performed as a downconverter, with low side LO and configured as shown in application circuit.



GaAs MMIC MIXER w/ INTEGRATED LO AMPLIFIER, 0.5 - 2.7 GHz

Conversion Gain vs. Temperature, IF = 100 MHz

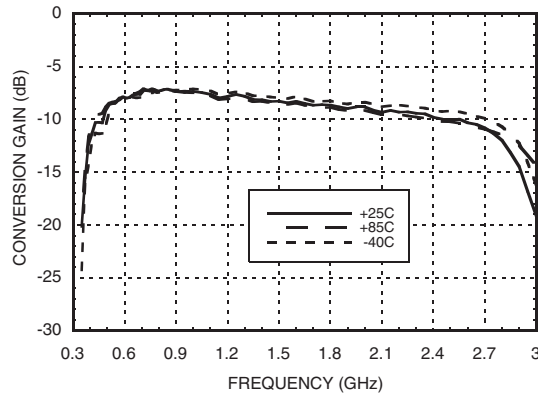

Conversion Gain vs. Temperature, IF = 1 GHz

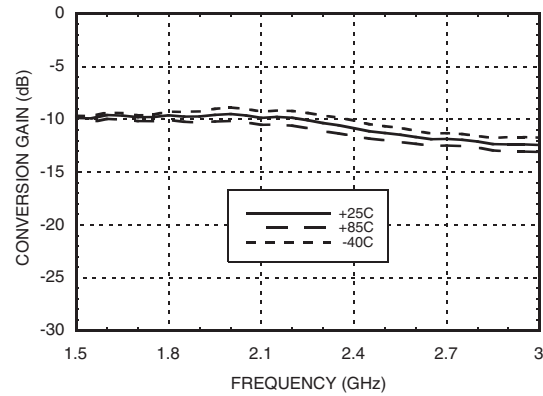

Isolation

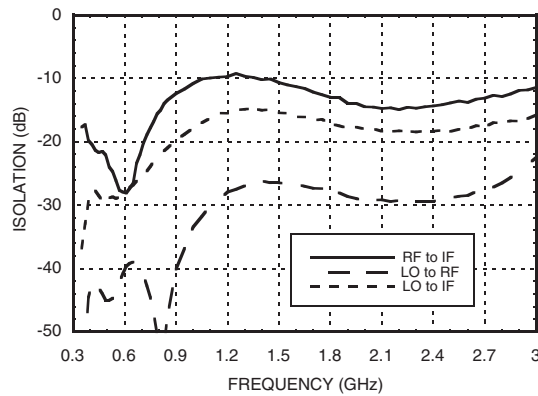

Conversion Gain vs. LO Drive

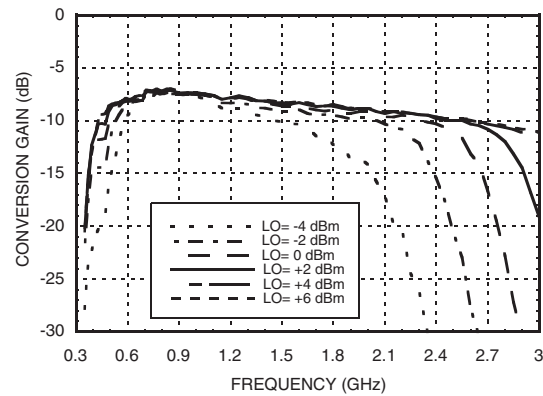

Return Loss

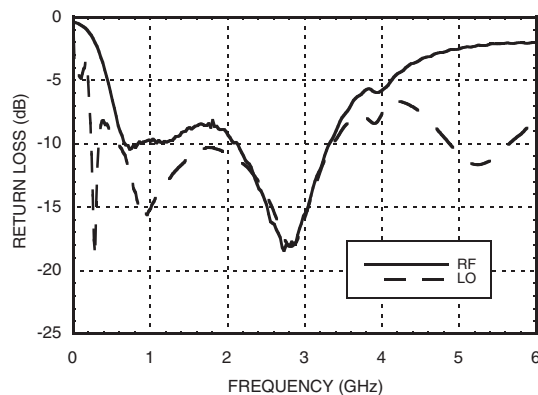

Upconverter Performance Input IP3 vs. LO Drive

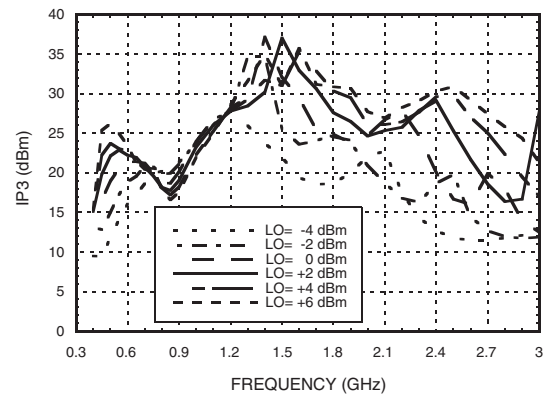

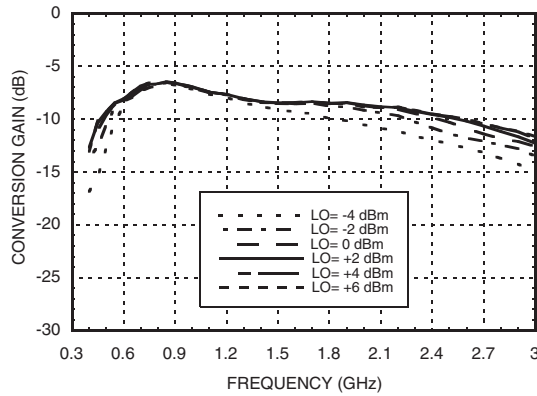
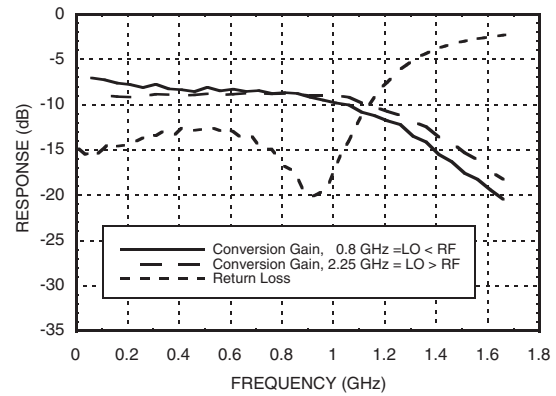
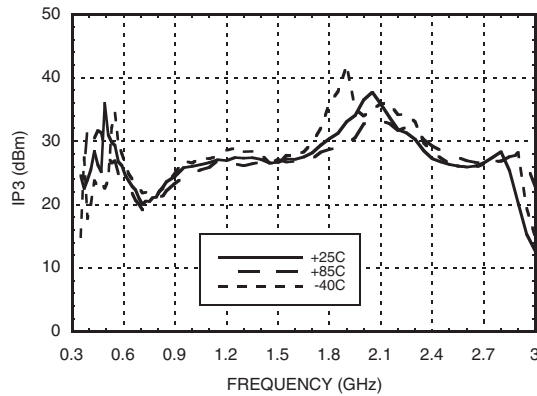
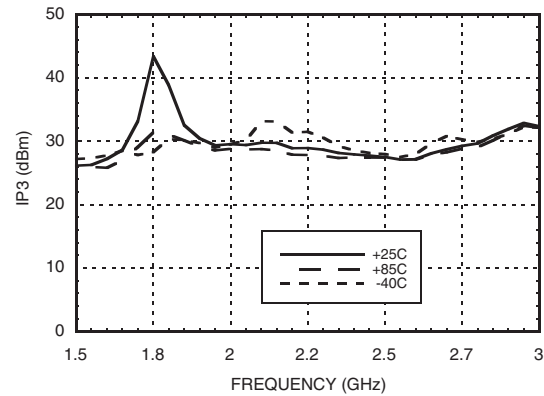
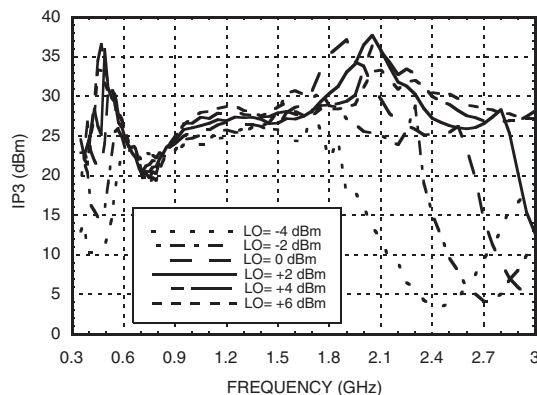
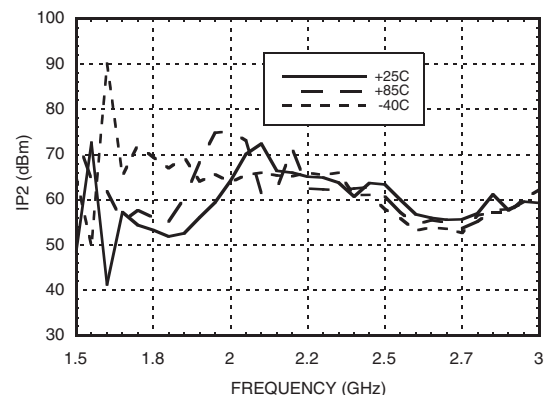
**GaAs MMIC MIXER w/ INTEGRATED
LO AMPLIFIER, 0.5 - 2.7 GHz**
**Upconverter Performance
Conversion Gain vs. LO Drive**

IF Bandwidth

Input IP3 vs. Temperature, IF = 100 MHz

Input IP3 vs. Temperature, IF = 1 GHz

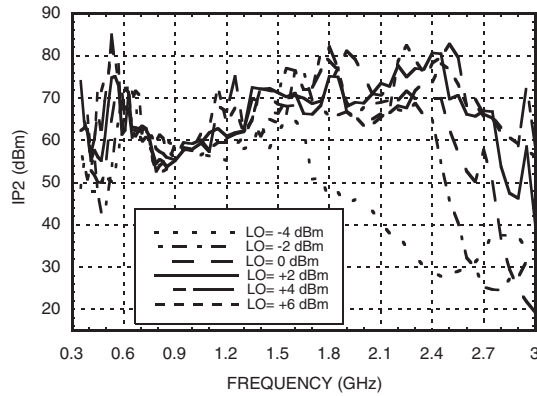
Input IP3 vs. LO Drive, IF = 100 MHz

Input IP2 vs. Temperature



GaAs MMIC MIXER w/ INTEGRATED LO AMPLIFIER, 0.5 - 2.7 GHz

Input IP2 vs. LO Drive



Input P1dB vs. Temperature

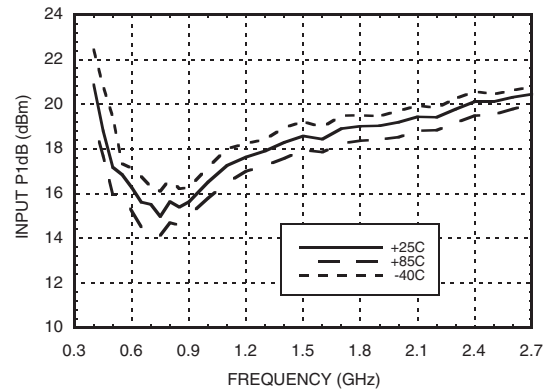

Absolute Maximum Ratings

Bias Voltage (Vdd)	5.5 Vdc
RF Power Input	+23 dBm
LO Power Input (Vcc = 5 Vdc)	+10 dBm up to 1 GHz +8 dBm from 1 - 4 GHz
Channel Temperature	150°C
Continuous P _{diss} (T = 85°C) (derate 8.4 mW/°C above 85°C)	0.546 W
Thermal Resistance (junction to ground paddle)	119 °C/W
Storage Temperature	-65 to +150°C
Operating Temperature	-55 to +85°C
ESD Sensitivity (HBM)	Class 1C

MxN Spurious @ IF Port

mRF	nLO			
	0	1	2	3
0	xx	-3.17	-23.34	-30.34
1	-4.67	0.00	-23.67	-52.17
2	-76.00	-71.34	-79.84	-71.84
3	xx	xx	xx	-74.67
4	xx	xx	xx	xx

RF Freq. = 1.9 GHz @ -5 dBm
LO Freq. = 1.8 GHz @ 0 dBm
All values in dBc below the IF output power level.

Typical Supply Current

Vcc	I _{cc} (mA)
4.5	67 mA
5.0	88 mA
5.5	117 mA



**ELECTROSTATIC SENSITIVE DEVICE
OBSERVE HANDLING PRECAUTIONS**

Harmonics of LO

LO Freq. (GHz)	nLO Spur @ RF Port			
	1	2	3	4
1.0	32	40	27	40
1.4	28	19	25	30
1.8	29	16	30	42
2.2	33	18	27	44
2.6	35	23	34	41
3.0	34	20	41	44

LO = 4 dBm
All values in dBc below input LO level measured at RF port.

Outline Drawing

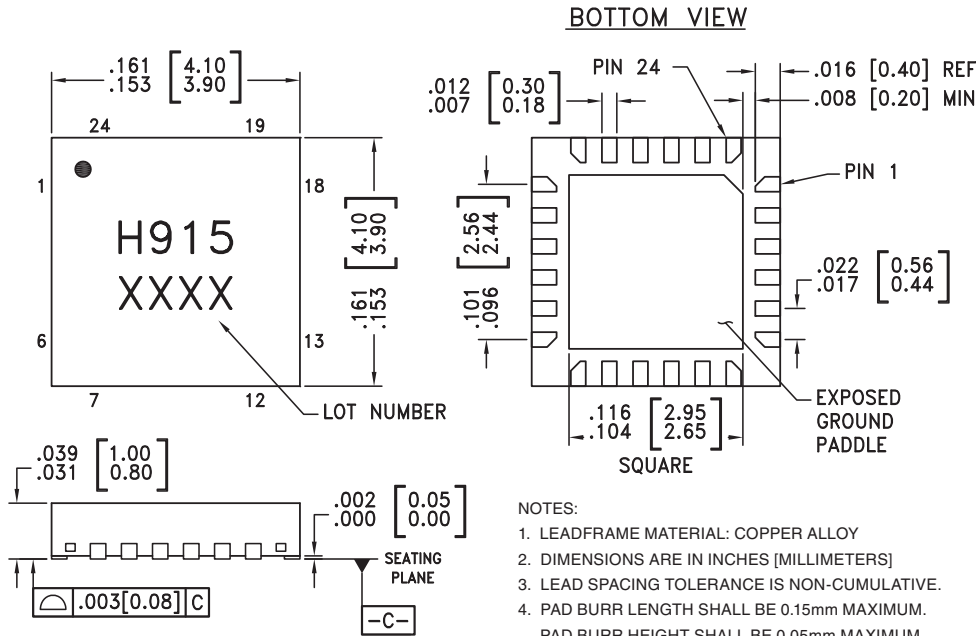

- NOTES:
1. LEADFRAME MATERIAL: COPPER ALLOY
 2. DIMENSIONS ARE IN INCHES [MILLIMETERS]
 3. LEAD SPACING TOLERANCE IS NON-CUMULATIVE.
 4. PAD BURR LENGTH SHALL BE 0.15mm MAXIMUM.
PAD BURR HEIGHT SHALL BE 0.05mm MAXIMUM.
 5. PACKAGE WARP SHALL NOT EXCEED 0.05mm.
 6. ALL GROUND LEADS AND GROUND PADDLE MUST BE SOLDERED TO PCB RF GROUND.
 7. REFER TO HITTITE APPLICATION NOTE FOR SUGGESTED LAND PATTERN.

Package Information



Part Number	Package Body Material	Lead Finish	MSL Rating	Package Marking ^[1]
HMC915LP4E	RoHS-compliant Low Stress Injection Molded Plastic	100% matte Sn	MSL1 ^[2]	H915 XXXX

[1] 4-Digit lot number XXXX

[2] Max peak reflow temperature of 260 °C

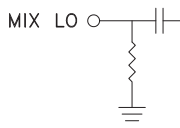
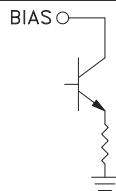

Pin Descriptions

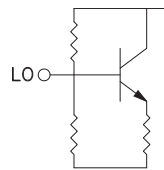
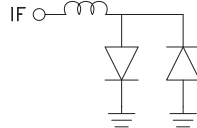
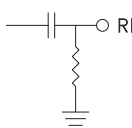
Pin Number	Function	Description	Interface Schematic
1	MIX LO	This pin is DC coupled and matched to 50 Ohms.	
2, 6 - 9, 11 - 17, 19 - 24	N/C	The pins are not connected internally; however, all data shown herein was measured with these pins connected to RF/DC ground externally.	
3	BIAS	Power supply and output for the LO amplifier. Three external bypass capacitors are recommended for optimum performance, as illustrated in the application circuit.	
4	GND	Backside of package has exposed metal ground paddle that must also be connected to ground.	
5	LO	This pin is DC coupled and matched to 50 Ohms. An off chip DC blocking capacitor is required.	
10	IF	This pin is DC coupled. For applications not requiring operation to DC, this port should be DC blocked externally using a series capacitor whose value has been chosen to pass the necessary IF frequency range. For operation to DC, this pin must not source/sink more than 18 mA of current or die non-function and possible die failure will result.	
18	RF	This pin is DC coupled and matched to 50 Ohms.	

Application Circuit

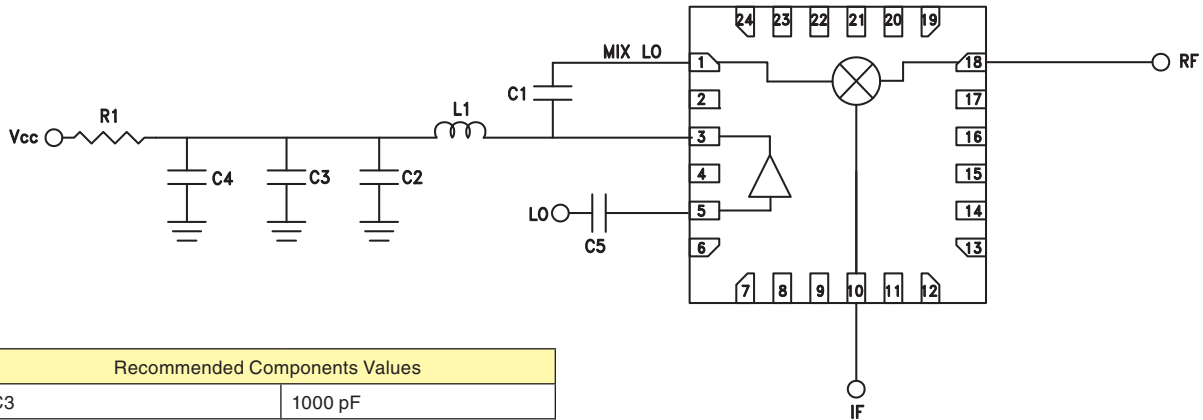

Recommended Components Values	
C3	1000 pF
C4	2.2 μ F
C1, C2, C5	100 pF
L1	24 nH
R1	1.8 Ohm

Evaluation PCB

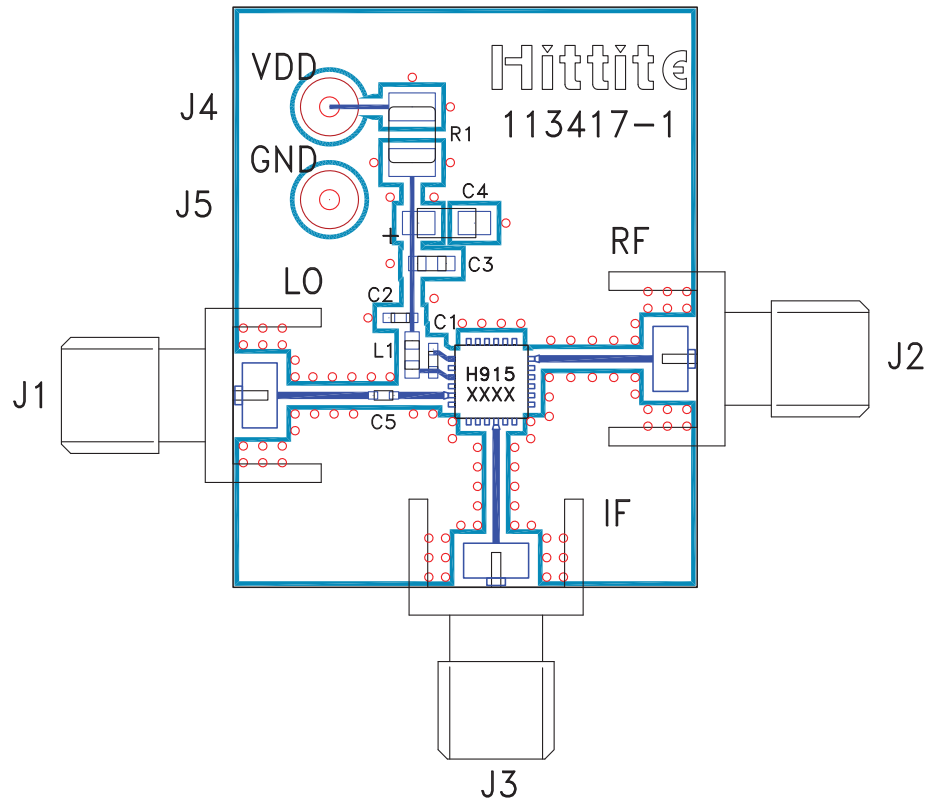

List of Materials for Evaluation PCB 115820 [1]

Item	Description
J1 - J3	PCB Mount SMA RF Connector
J4, J5	DC Pin
C1, C2, C5	100 pF Chip Capacitor, 0402 Pkg.
C3	1000 pF Chip Capacitor, 0603 Pkg.
C4	2.2 μ F Capacitor, Tantalum
L1	24 nH Chip Inductor, 0603 Pkg.
R1	1.8 Ohm Resistor, 1206 1/4 Watt Pkg.
U1	HMC915LP4E
PCB [2]	113417 Evaluation PCB

[1] Reference this number when ordering complete evaluation PCB

[2] Circuit Board Material: Rogers 4350 or Arlon 25FR

The circuit board used should use RF circuit design techniques. Signal lines should have 50 ohm impedance while the package ground leads and exposed paddle should be connected directly to the ground plane similar to that shown. A sufficient number of via holes should be used to connect the top and bottom ground planes. The evaluation circuit board shown is available from Hittite upon request.

Looking for pricing, stock, or lifecycle information?

Click below to explore more details on WIN SOURCE:

- ⊖ [View HMC915LP4ETR on WIN SOURCE](#)
- ⊖ [Analog Devices Inc. Information](#)

Optimize Your Supply Chain with WIN SOURCE Solutions

- ✓ Global Sourcing Solution
- ✓ Obsolete Management
- ✓ Cost Control Management
- ✓ Shortage Management
- ✓ Alternative Solution
- ✓ Excess Inventory Management