



THE DATASHEET OF HMC784MS8GETR



GaAs MMIC 10 WATT T/R SWITCH DC - 4 GHz



Typical Applications

The HMC784MS8GE is ideal for:

- Cellular / 4G Infrastructure
- WiMAX, WiBro & Fixed Wireless
- Automotive Telematics
- Mobile Radio
- Test Equipment

Features

- Input P1dB: +40 dBm @ Vdd = +8V
- High Third Order Intercept: +62 dBm
- Positive Control: +3 to +8 V
- Low Insertion Loss: 0.4 dB
- MSOP8G Package: 14.8 mm²

Functional Diagram

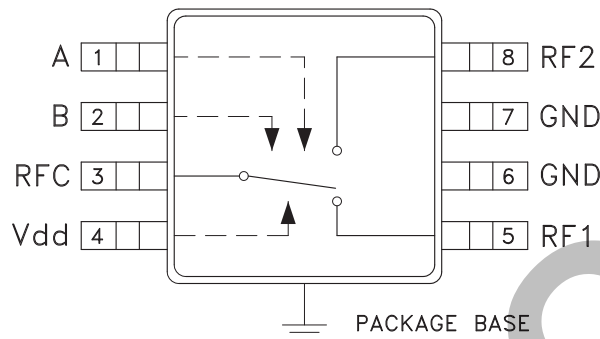

General Description

The HMC784MS8GE is a high power SPDT switch in an 8-lead MSOP8G package for use in transmit-receive applications which require very low distortion at high input signal power levels. The device can control signals from DC to 4 GHz. The design provides exceptional intermodulation performance; > +60 dBm third order intercept at +5V bias. RF1 and RF2 are reflective shorts when "OFF". On-chip circuitry allows single positive supply operation from +3 Vdc to +8 Vdc at very low DC current with control inputs compatible with CMOS and most TTL logic families.

Electrical Specifications,

$T_A = +25^\circ C$, $V_{ctl} = 0/V_{dd}$, $V_{dd} = +5V$ (Unless Otherwise Stated), 50 Ohm System

Parameter	Frequency	Min.	Typ.	Max.	Units
Insertion Loss	DC - 1.0 GHz		0.4	0.6	dB
	DC - 2.0 GHz		0.6	0.8	dB
	DC - 2.5 GHz		0.8	1.1	dB
	DC - 3.0 GHz		0.9	1.3	dB
	DC - 4.0 GHz		1.3	2.0	dB
Isolation	DC - 4.0 GHz	26	30		dB
Return Loss (On State)	DC - 1.0 GHz		35		dB
	DC - 2.0 GHz		30		dB
	DC - 3.0 GHz		20		dB
	DC - 4.0 GHz		10		dB
Input Power for 0.1dB Compression	Vdd = +3V		32		dBm
	Vdd = +5V	0.1 - 4.0 GHz	37		dBm
	Vdd = +8V		38		dBm
Input Power for 1dB Compression	Vdd = +3V		32	35	dBm
	Vdd = +5V	0.1 - 4.0 GHz	35	38	dBm
	Vdd = +8V		38	41	dBm
Input Third Order Intercept (Two-tone input power = +30 dBm each tone)	0.02 - 0.1 GHz		42		dBm
	0.1 - 2.0 GHz		62		dBm
	0.1 - 3.0 GHz		61		dBm
	0.1 - 4.0 GHz		60		dBm
Switching Characteristics	tRISE, tFALL (10/90% RF)		15		ns
	tON, tOFF (50% CTL to 10/90% RF)	DC - 4.0 GHz	40		ns

Information furnished by Analog Devices is believed to be accurate and reliable. However, no responsibility is assumed by Analog Devices for its use, nor for any infringements of patents or other rights of third parties that may result from its use. Specifications subject to change without notice. No license is granted by implication or otherwise under any patent or patent rights of Analog Devices. Trademarks and registered trademarks are the property of their respective owners.

For price, delivery, and to place orders: Analog Devices, Inc., One Technology Way, P.O. Box 9106, Norwood, MA 02062-9106
Phone: 781-329-4700 • Order online at www.analog.com
Application Support: Phone: 1-800-ANALOG-D



**GaAs MMIC 10 WATT T/R SWITCH
DC - 4 GHz**

Insertion Loss vs. Temperature

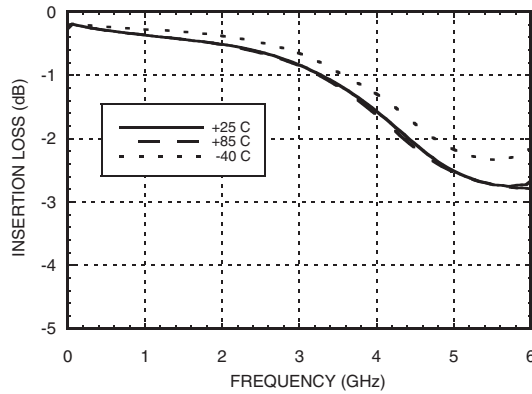

Isolation

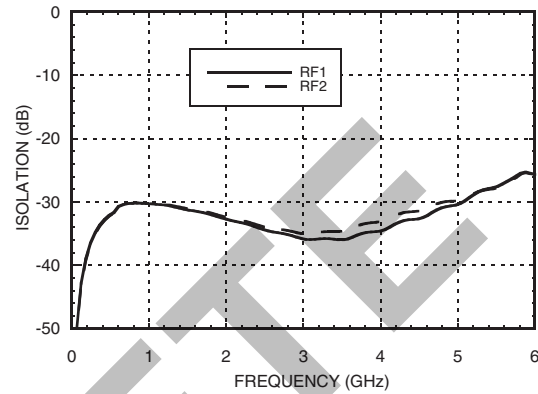

Insertion Loss vs. Vdd

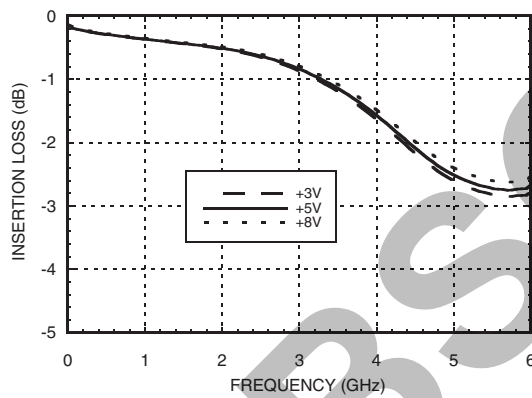

Isolation vs. Vdd

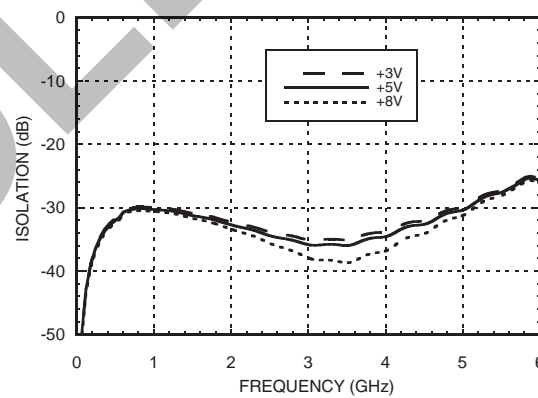

Return Loss

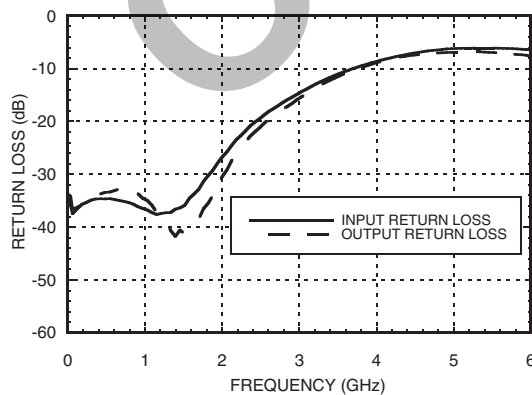

RF1 to RF2 Isolation

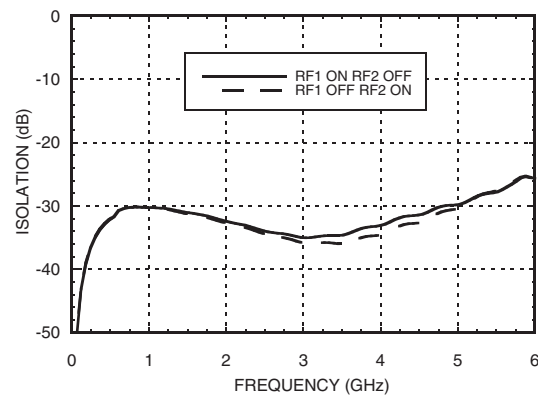

Information furnished by Analog Devices is believed to be accurate and reliable. However, no responsibility is assumed by Analog Devices for its use, nor for any infringements of patents or other rights of third parties that may result from its use. Specifications subject to change without notice. No license is granted by implication or otherwise under any patent or patent rights of Analog Devices. Trademarks and registered trademarks are the property of their respective owners.

For price, delivery, and to place orders: Analog Devices, Inc., One Technology Way, P.O. Box 9106, Norwood, MA 02062-9106 Phone: 781-329-4700 • Order online at www.analog.com Application Support: Phone: 1-800-ANALOG-D



**GaAs MMIC 10 WATT T/R SWITCH
DC - 4 GHz**

Input P1dB vs. Vdd

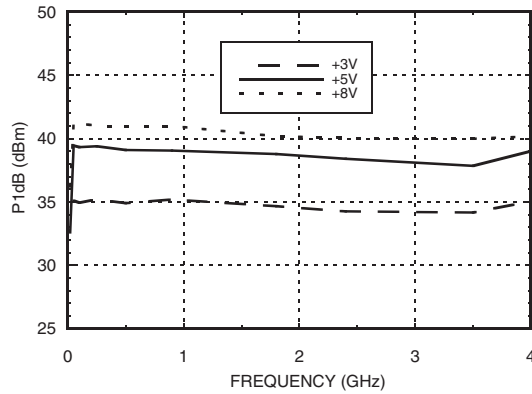

Input P0.1dB vs. Vdd

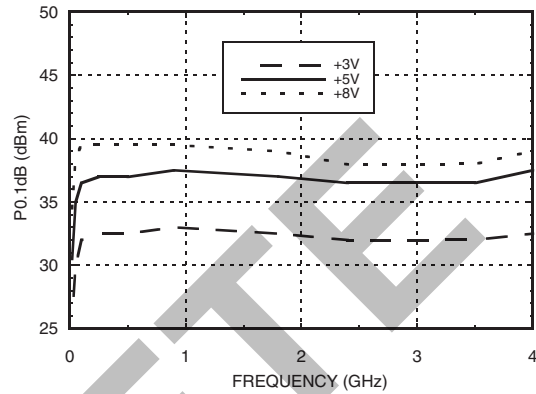

Input P1dB vs. Temperature @ Vdd = +5V

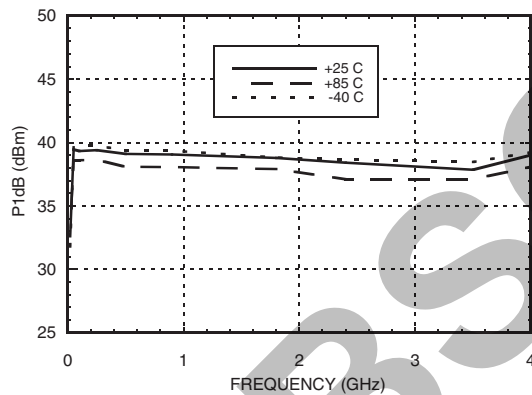

Input IP3 vs. Tone Power @ Vdd = +3V

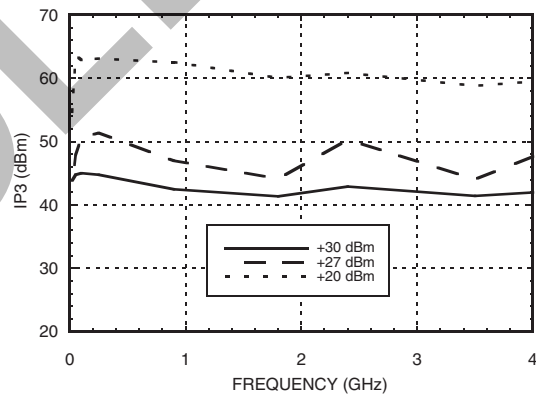

Input IP3 vs. Tone Power @ Vdd = +5V

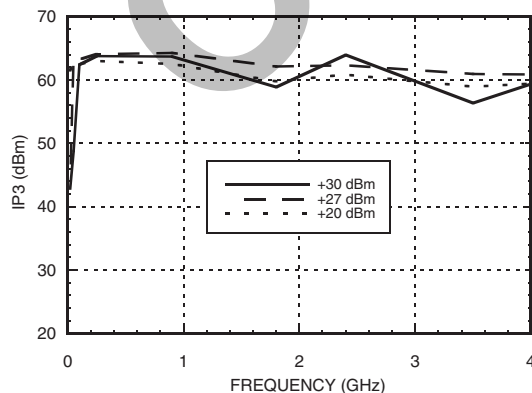

Input IP3 vs. Tone Power @ Vdd = +8V

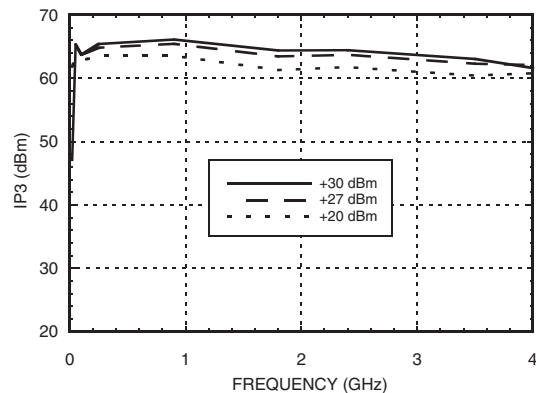

Information furnished by Analog Devices is believed to be accurate and reliable. However, no responsibility is assumed by Analog Devices for its use, nor for any infringements of patents or other rights of third parties that may result from its use. Specifications subject to change without notice. No license is granted by implication or otherwise under any patent or patent rights of Analog Devices. Trademarks and registered trademarks are the property of their respective owners.

For price, delivery, and to place orders: Analog Devices, Inc., One Technology Way, P.O. Box 9106, Norwood, MA 02062-9106 Phone: 781-329-4700 • Order online at www.analog.com Application Support: Phone: 1-800-ANALOG-D



**GaAs MMIC 10 WATT T/R SWITCH
DC - 4 GHz**

**Input IP3 vs. Temperature
27 dBm Tones, Vdd = +3V**

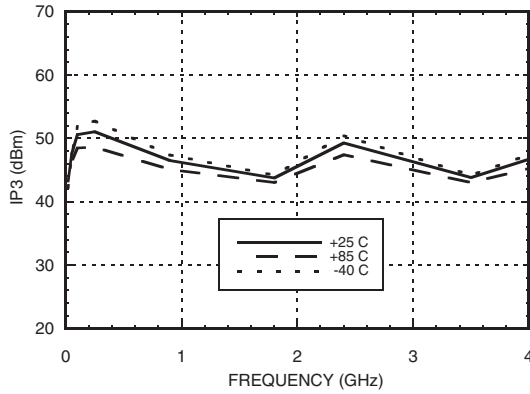

**Input IP3 vs. Temperature
27 dBm Tones, Vdd = +5V**

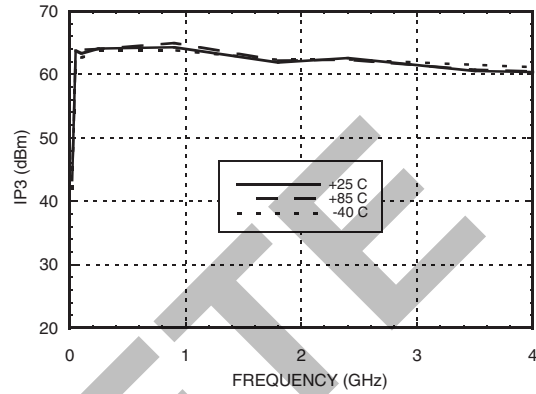

**Input IP3 vs. Temperature
27 dBm Tones, Vdd = +8V**

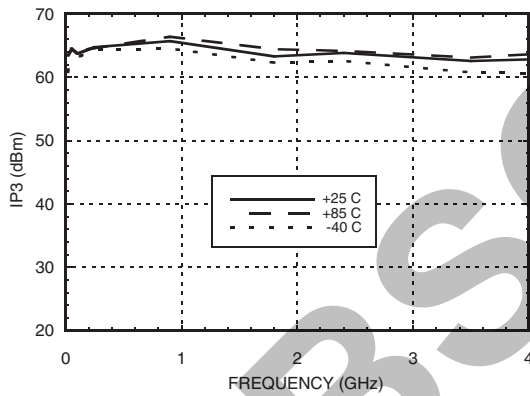

Input P1dB vs. Vdd

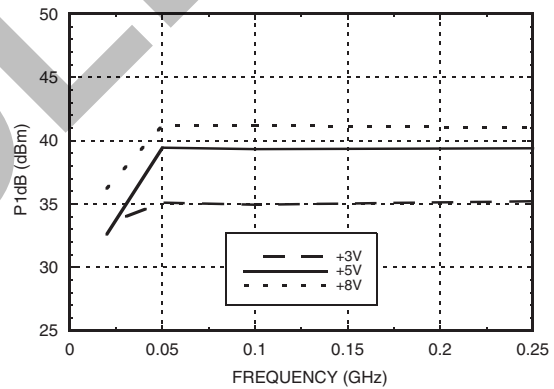

Input P0.1dB vs. Vdd

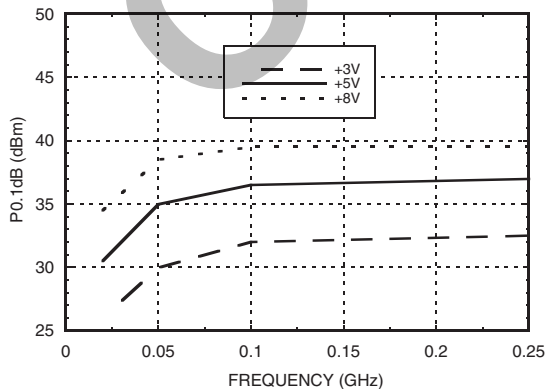

Input IP3 vs. Tone Power @ Vdd = +5V

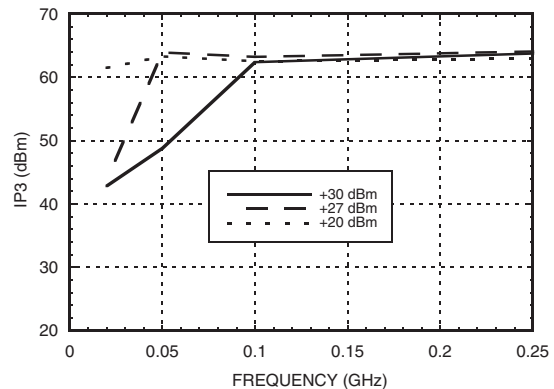

Information furnished by Analog Devices is believed to be accurate and reliable. However, no responsibility is assumed by Analog Devices for its use, nor for any infringements of patents or other rights of third parties that may result from its use. Specifications subject to change without notice. No license is granted by implication or otherwise under any patent or patent rights of Analog Devices. Trademarks and registered trademarks are the property of their respective owners.

For price, delivery, and to place orders: Analog Devices, Inc., One Technology Way, P.O. Box 9106, Norwood, MA 02062-9106 Phone: 781-329-4700 • Order online at www.analog.com Application Support: Phone: 1-800-ANALOG-D

**GaAs MMIC 10 WATT T/R SWITCH
DC - 4 GHz**
Bias Voltage & Current

Vdd (V)	Typical I _{dd} (μA)
+3	0.5
+5	2
+8	20

Control Voltages & Currents

State	Vdd = +3V (μA)	Vdd = +5V (μA)	Vdd = +8V (μA)
Low (0 to +0.2V)	0.5	2	20
High (Vdd ±0.2V)	0.1	0.1	0.1

Truth Table

Control Input (Vctl)		Signal Path State	
A	B	RFC to RF1	RFC to RF2
High	Low	Off	On
Low	High	On	Off

Absolute Maximum Ratings

RF Input Power (Vdd = +8V, 50 Ohm source & load impedances)	+39 dBm (T = +85 °C)
Supply Voltage Range (Vdd) (Vctl = 0V)	-0.2 to +9V
Control Voltage Range (A & B)	-0.2 to Vdd +0.5V
Channel Temperature	150 °C
Continuous Pdiss (T = 85 °C) (derate 25 mW/°C above 85 °C)	1.217 W
Thermal Resistance (Channel to ground paddle)	53.4 °C/W
Storage Temperature	-65 to +150 °C
Operating Temperature	-40 to +85 °C
ESD Rating	Class 1A HBM

Note: DC blocking capacitors are required at ports RFC, RF1 and RF2. Their value will determine the lowest transmission frequency.



**ELECTROSTATIC SENSITIVE DEVICE
OBSERVE HANDLING PRECAUTIONS**

GaAs MMIC 10 WATT T/R SWITCH DC - 4 GHz



Outline Drawing

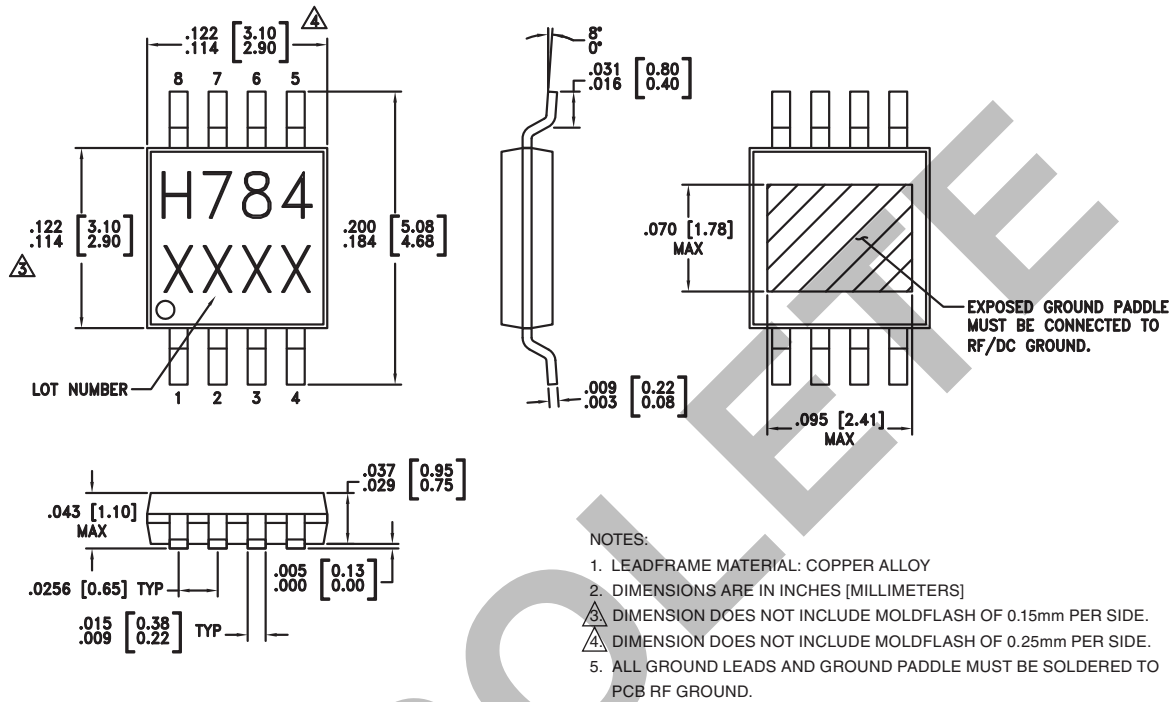



Package Information

Part Number	Package Body Material	Lead Finish	MSL Rating	Package Marking ^[1]
HMC784MS8GE	RoHS-compliant Low Stress Injection Molded Plastic	100% matte Sn	MSL1 ^[2]	H784 XXXX

[1] 4-Digit lot number XXXX

[2] Max peak reflow temperature of 260 °C

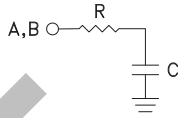
**GaAs MMIC 10 WATT T/R SWITCH
DC - 4 GHz**
Pin Descriptions

Pin Number	Function	Description	Interface Schematic
1	A	See truth table and control voltage table.	
2	B	See truth table and control voltage table.	
3, 5, 8	RFC, RF1, RF2	This pin is DC coupled and matched to 50 Ohms. Blocking capacitors are required.	
4	Vdd	Supply Voltage	
6, 7	GND	Package bottom must also be connected to PCB RF ground.	

11

SWITCHES - SPDT - SMT

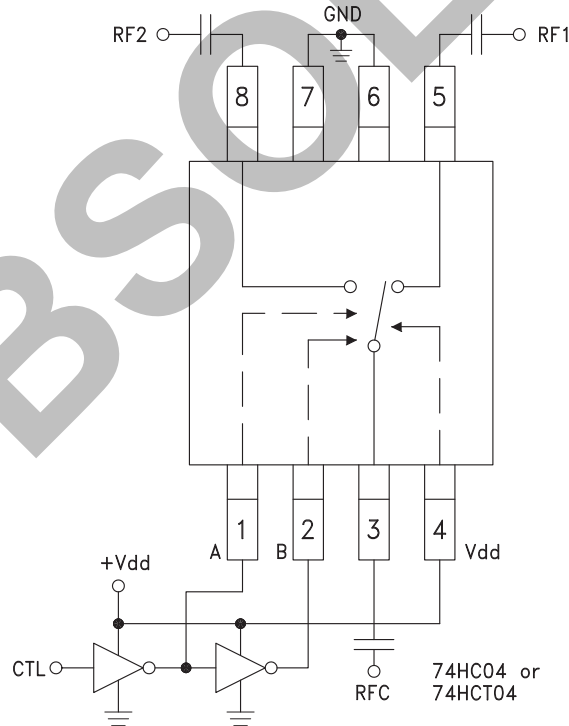
Typical Application Circuit

Notes:

1. Set logic gate and switch Vdd = +3V to +8V and use HCT series logic to provide a TTL driver interface.
2. Control inputs A/B can be driven directly with CMOS logic (HC) with Vdd of +3 to +8 Volts applied to the CMOS logic gates and to pin 4 of the RF switch.
3. DC Blocking capacitors are required for each RF port as shown. Capacitor value determines lowest frequency of operation.
4. Highest RF signal power capability is achieved with V set to +8V. The switch will operate properly (but at lower RF power capability) at bias voltages down to +3V.

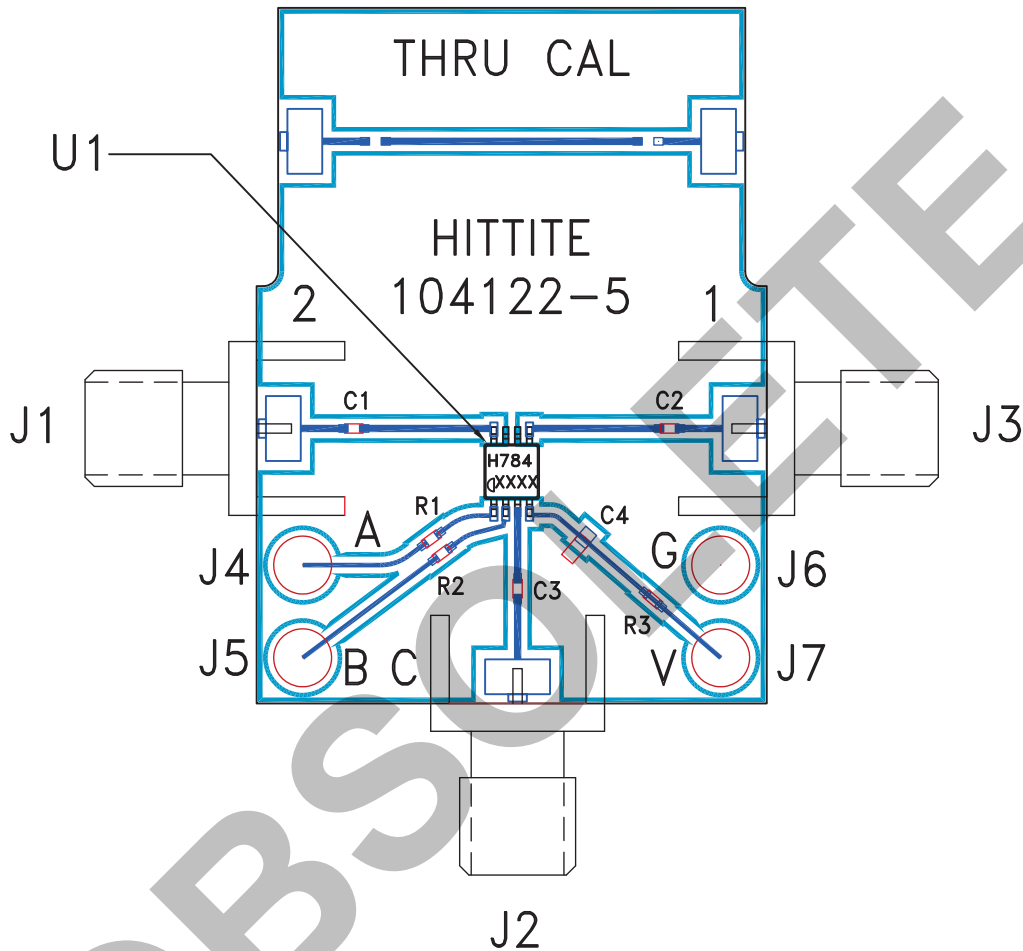

Evaluation Circuit Board



List of Materials for Evaluation PCB 104124 [1]

Item	Description
J1 - J3	PCB Mount SMA RF Connector
J4 - J7	DC Pin
C1 - C3	100 pF capacitor, 0402 Pkg.
C4	10 KpF capacitor, 0603 Pkg.
R1 - R3	100 Ohm Resistor, 0402 Pkg.
U1	HMC784MS8GE T/R Switch
PCB [2]	104122 Evaluation PCB



[1] Reference this number when ordering complete evaluation PCB

[2] Circuit Board Material: Rogers 4350

The circuit board used in the final application should be generated with proper RF circuit design techniques. Signal lines at the RF port should have 50 ohm impedance and the package ground leads and package bottom should be connected directly to the ground plane similar to that shown above. The evaluation circuit board shown above is available from Hittite Microwave Corporation upon request.

Looking for pricing, stock, or lifecycle information?

Click below to explore more details on WIN SOURCE:

-  [View HMC784MS8GETR on WIN SOURCE](#)
-  [Analog Devices Inc. Information](#)

Optimize Your Supply Chain with WIN SOURCE Solutions

-  Global Sourcing Solution
-  Obsolete Management
-  Cost Control Management
-  Shortage Management
-  Alternative Solution
-  Excess Inventory Management