



**THE DATASHEET OF
HMC636ST89ETR**



GaAs PHEMT HIGH LINEARITY Gain Block, 0.2 - 4.0 GHz



Typical Applications

The HMC636ST89(E) is ideal for:

- Cellular / PCS / 3G
- WiMAX, WiBro, & Fixed Wireless
- CATV & Cable Modem
- Microwave Radio

Features

- Low Noise Figure: 2.2 dB
- High P1dB Output Power: +22 dBm
- High Output IP3: +40 dBm
- Gain: 13 dB
- 50 Ohm I/O's - No External Matching
- Industry Standard SOT89 Package

Functional Diagram

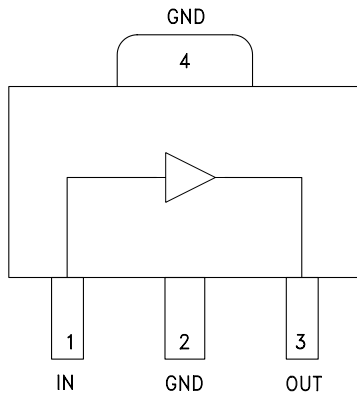

General Description

The HMC636ST89(E) is a GaAs pHEMT, High Linearity, Low Noise, Wideband Gain Block Amplifier covering 0.2 to 4.0 GHz. Packaged in an industry standard SOT89, the amplifier can be used as either a cascadable 50 Ohm gain stage, a PA Pre-Driver, a Low Noise Amplifier, or a Gain Block with up to +23 dBm output power. This versatile Gain Block Amplifier is powered from a single +5V supply and requires no external matching components. The internally matched topology makes this amplifier compatible with virtually any PCB material or thickness.

Electrical Specifications, $V_s = 5.0\text{ V}$, $T_A = +25^\circ\text{ C}$

Parameter	Min	Typ.	Max	Min.	Typ.	Max.	Units
Frequency Range	0.2 - 2.0			2.0 - 4.0			GHz
Gain	10	13		5	10		dB
Gain Variation Over Temperature		0.01	0.02		0.01	0.02	dB/ °C
Input Return Loss		10			10		dB
Output Return Loss		13			15		dB
Reverse Isolation		22			20		dB
Output Power for 1 dB Compression (P1dB)	19	22		20	23		dBm
Output Third Order Intercept (IP3)	36	39		36	39		dBm
Noise Figure		2.5			2		dB
Supply Current (Icq)		155			155	175	mA

Note: Data taken with broadband bias tee on device output.



**GaAs PHEMT HIGH LINEARITY
Gain Block, 0.2 - 4.0 GHz**

Broadband Gain & Return Loss

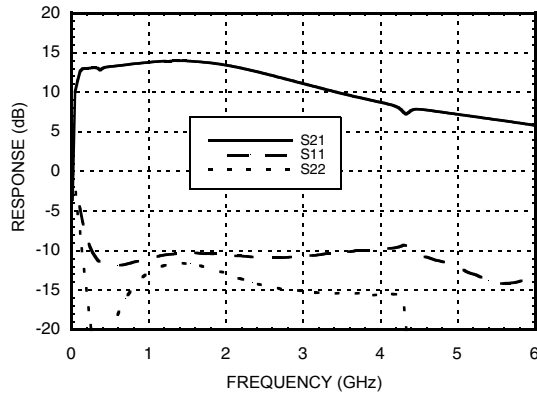

Gain vs. Temperature

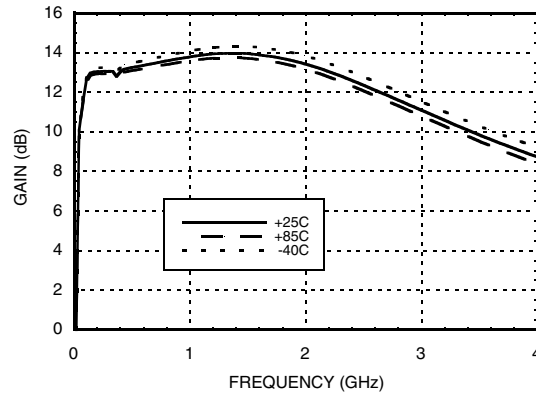

Input Return Loss vs. Temperature

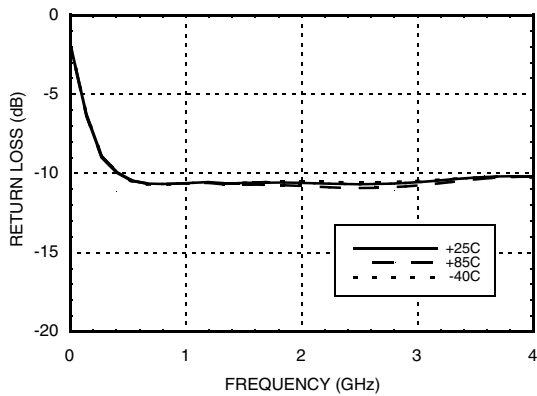

Output Return Loss vs. Temperature

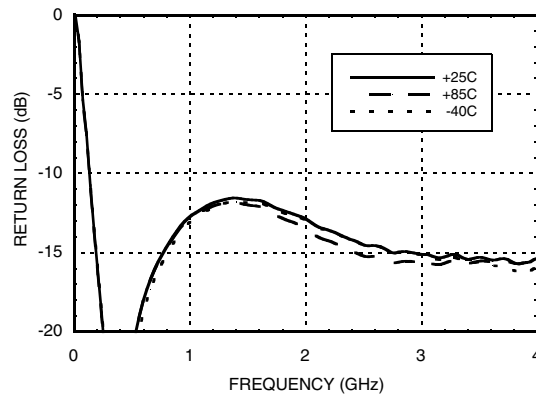

Reverse Isolation vs. Temperature

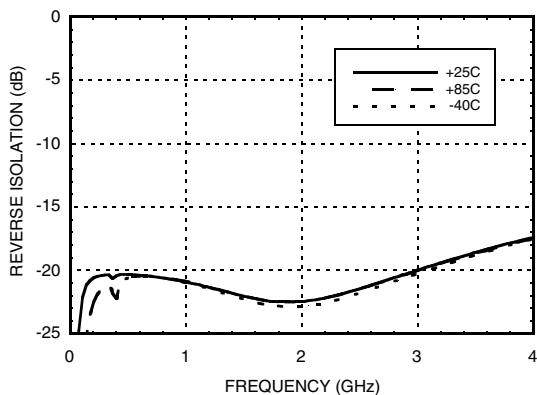

Noise Figure vs. Temperature

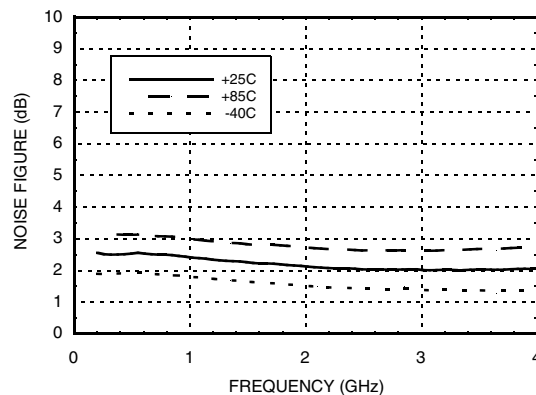

Information furnished by Analog Devices is believed to be accurate and reliable. However, no responsibility is assumed by Analog Devices for its use, nor for any infringements of patents or other rights of third parties that may result from its use. Specifications subject to change without notice. No license is granted by implication or otherwise under any patent or patent rights of Analog Devices. Trademarks and registered trademarks are the property of their respective owners.

For price, delivery, and to place orders: Analog Devices, Inc., One Technology Way, P.O. Box 9106, Norwood, MA 02062-9106 Phone: 781-329-4700 • Order online at www.analog.com Application Support: Phone: 1-800-ANALOG-D



**GaAs PHEMT HIGH LINEARITY
Gain Block, 0.2 - 4.0 GHz**

P1dB vs. Temperature

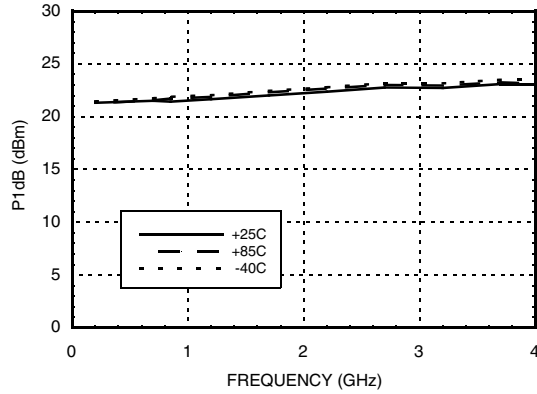

Psat vs. Temperature

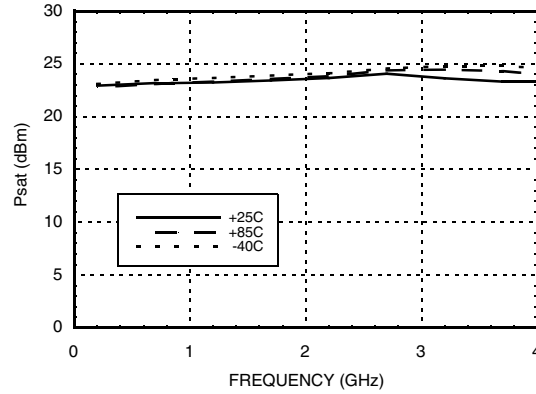

Power Compression @ 850 MHz

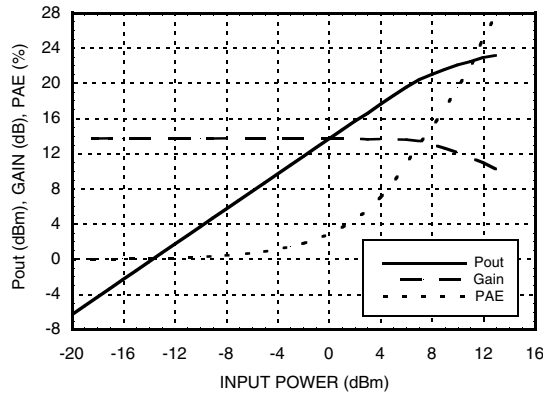

Power Compression @ 2200 MHz

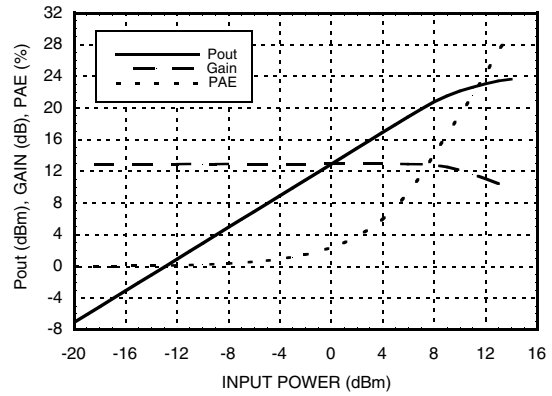

Output IP3 vs. Input Tone Power

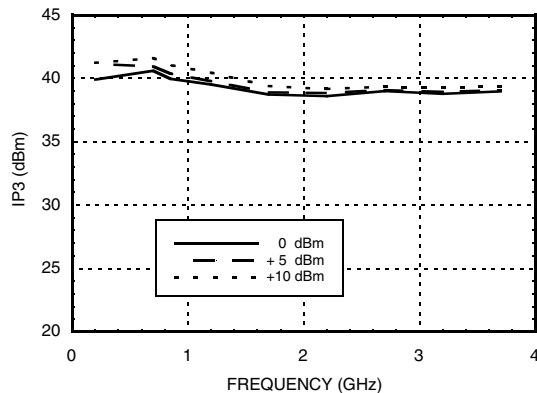

Gain, Power, Output IP3 & Supply Current vs. Supply Voltage @ 850 MHz

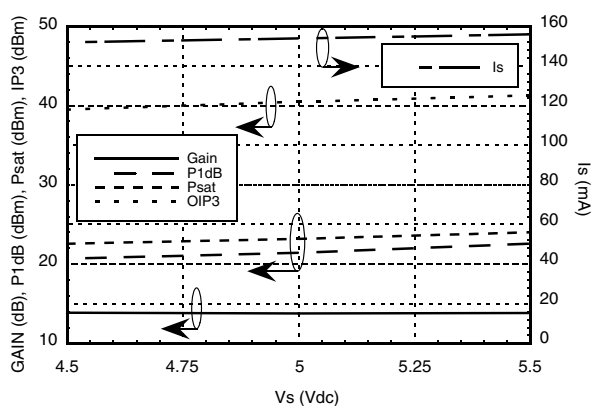

Information furnished by Analog Devices is believed to be accurate and reliable. However, no responsibility is assumed by Analog Devices for its use, nor for any infringements of patents or other rights of third parties that may result from its use. Specifications subject to change without notice. No license is granted by implication or otherwise under any patent or patent rights of Analog Devices. Trademarks and registered trademarks are the property of their respective owners.

For price, delivery, and to place orders: Analog Devices, Inc., One Technology Way, P.O. Box 9106, Norwood, MA 02062-9106 Phone: 781-329-4700 • Order online at www.analog.com Application Support: Phone: 1-800-ANALOG-D

GaAs PHEMT HIGH LINEARITY Gain Block, 0.2 - 4.0 GHz



Absolute Maximum Ratings

Collector Bias Voltage (Vcc)	+5.5 Volts
RF Input Power (RFIN)(Vcc = +5 Vdc)	+16 dBm
Channel Temperature	150 °C
Continuous Pdiss (T = 85 °C) (derate 13.3 mW/°C above 85 °C)	0.86 W
Thermal Resistance (Channel to lead)	75.6 °C/W
Storage Temperature	-65 to +150 °C
Operating Temperature	-40 to +85 °C
ESD Sensitivity (HBM)	Class 1A



ELECTROSTATIC SENSITIVE DEVICE
OBSERVE HANDLING PRECAUTIONS

9

Outline Drawing

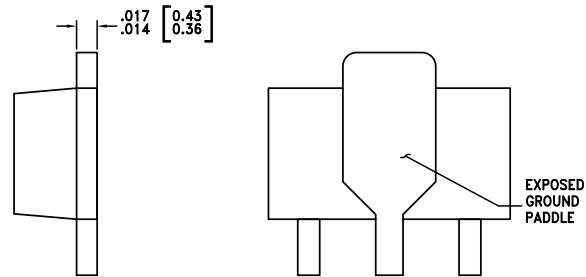
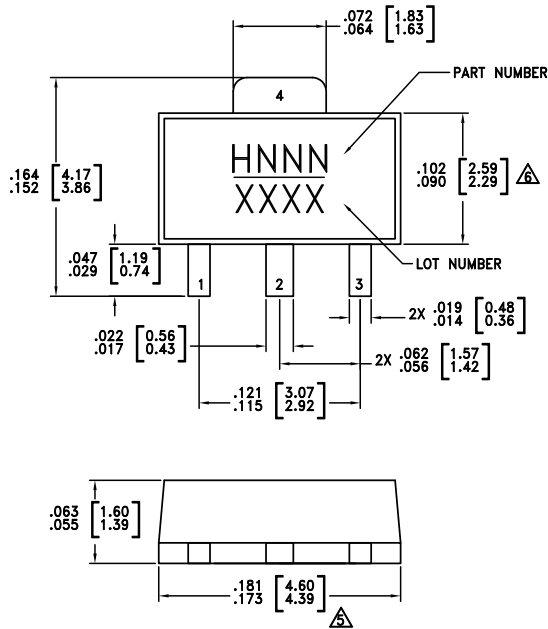

NOTES:

- PACKAGE BODY MATERIAL:
MOLDING COMPOUND MP-180S OR EQUIVALENT.
- LEAD MATERIAL: Cu w/ Ag SPOT PLATING.
- LEAD PLATING: 100% MATTE TIN.
- DIMENSIONS ARE IN INCHES [MILLIMETERS]
- Δ DIMENSION DOES NOT INCLUDE MOLDFLASH OF 0.15mm PER SIDE.
- Δ DIMENSION DOES NOT INCLUDE MOLDFLASH OF 0.25mm PER SIDE.
- ALL GROUND LEADS MUST BE SOLDERED TO PCB RF GROUND.

Package Information

Part Number	Package Body Material	Lead Finish	MSL Rating	Package Marking ^[3]
HMC636ST89	Low Stress Injection Molded Plastic	Sn/Pb Solder	MSL1 ^[1]	H636 XXXX
HMC636ST89E	RoHS-compliant Low Stress Injection Molded Plastic	100% matte Sn	MSL1 ^[2]	H636 XXXX

[1] Max peak reflow temperature of 235 °C

[2] Max peak reflow temperature of 260 °C



[3] 4-Digit lot number XXXX

Information furnished by Analog Devices is believed to be accurate and reliable. However, no responsibility is assumed by Analog Devices for its use, nor for any infringements of patents or other rights of third parties that may result from its use. Specifications subject to change without notice. No license is granted by implication or otherwise under any patent or patent rights of Analog Devices. Trademarks and registered trademarks are the property of their respective owners.

For price, delivery, and to place orders: Analog Devices, Inc.,
One Technology Way, P.O. Box 9106, Norwood, MA 02062-9106
Phone: 781-329-4700 • Order online at www.analog.com
Application Support: Phone: 1-800-ANALOG-D

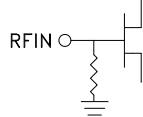
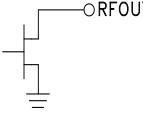

Pin Descriptions

Pin Number	Function	Description	Interface Schematic
1	RFIN	This pin is DC coupled. An off-chip DC blocking capacitor is required.	
3	RFOUT	RF Output and DC BIAS for the amplifier. See Application Circuit for off-chip components.	
2, 4	GND	These pins and package bottom must be connected to RF/DC ground.	

Application Circuit

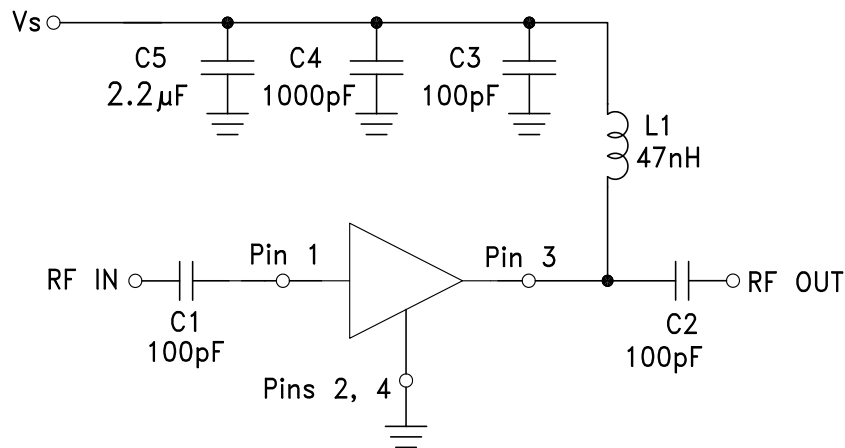

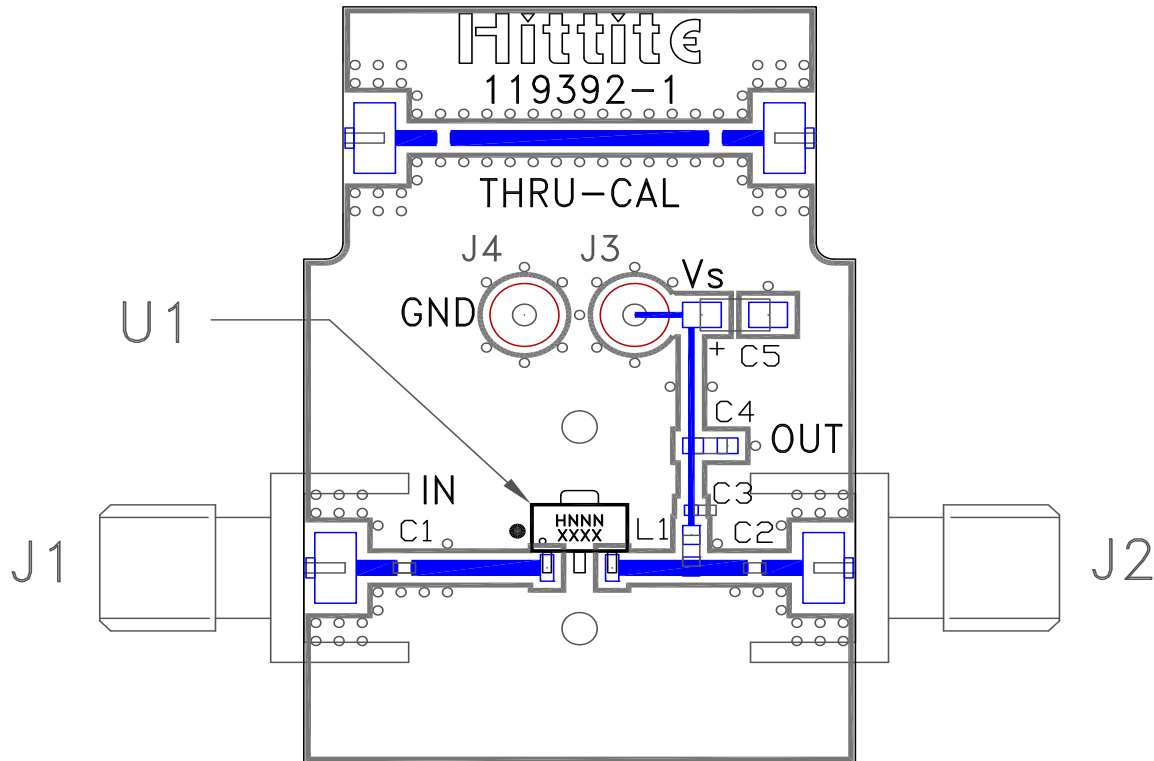
Evaluation PCB

List of Materials for Evaluation PCB 119394 [1]

Item	Description
J1 - J2	PCB Mount SMA Connector
J3 - J4	DC Pin
C1 - C3	100 pF Capacitor, 0402 Pkg.
C4	1000 pF Capacitor, 0603 Pkg.
C5	2.2 μ F Capacitor, Tantalum
L1	47 nH Inductor, 0603 Pkg.
U1	HMC636ST89(E)
PCB [2]	119392 Evaluation PCB



[1] Reference this number when ordering complete evaluation PCB

[2] Circuit Board Material: FR4

The circuit board used in the final application should use RF circuit design techniques. Signal lines should have 50 Ohm impedance while the package ground leads and package bottom should be connected directly to the ground plane similar to that shown. A sufficient number of via holes should be used to connect the top and bottom ground planes. The evaluation board should be mounted to an appropriate heat sink. The evaluation circuit board shown is available from Hittite upon request.

Looking for pricing, stock, or lifecycle information?

Click below to explore more details on WIN SOURCE:

-  [View HMC636ST89ETR on WIN SOURCE](#)
-  [Analog Devices Inc. Information](#)

Optimize Your Supply Chain with WIN SOURCE Solutions

-  Global Sourcing Solution
-  Obsolete Management
-  Cost Control Management
-  Shortage Management
-  Alternative Solution
-  Excess Inventory Management