



THE DATASHEET OF HMC580ST89E



Typical Applications

The HMC580ST89 / HMC580ST89E is ideal for:

- Cellular / PCS / 3G
- Fixed Wireless & WLAN
- CATV, Cable Modem & DBS
- Microwave Radio & Test Equipment
- IF & RF Applications

Features

- P1dB Output Power: +22 dBm
- Gain: 22 dB
- Output IP3: +37 dBm
- Cascadable 50 Ohm I/Os
- Single Supply: +5V
- Industry Standard SOT89 Package

Functional Diagram

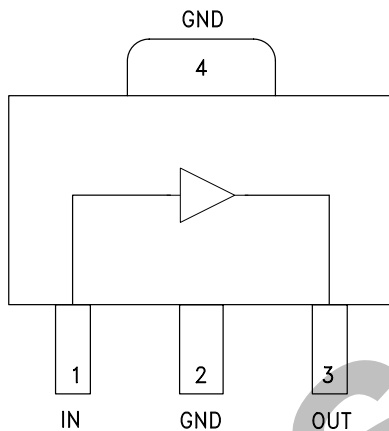

General Description

The HMC580ST89 & HMC580ST89E are InGaP Heterojunction Bipolar Transistor (HBT) Gain Block MMIC SMT amplifiers covering DC to 1 GHz. Packaged in an industry standard SOT89, the amplifier can be used as a cascadable 50 Ohm RF or IF gain stage as well as a PA or LO driver with up to +26 dBm output power. The HMC580ST89(E) offers 22 dB of gain with a +37 dBm output IP3 at 250 MHz, and can operate directly from a +5V supply. The HMC580ST89(E) exhibits excellent gain and output power stability over temperature, while requiring a minimal number of external bias components.

Electrical Specifications, $V_s = 5V$, $R_{bias} = 1.8 \text{ Ohm}$, $T_A = +25^\circ \text{ C}$

Parameter		Min.	Typ.	Max.	Units
Gain	DC - 0.25 GHz	19	22		dB
	0.25 - 0.50 GHz	18.5	21		dB
	0.50 - 1.00 GHz	15	17		dB
Gain Variation Over Temperature	DC - 1.0 GHz		0.005		dB/ °C
Input Return Loss	DC - 0.25 GHz		35		dB
	0.25 - 0.50 GHz		28		dB
	0.50 - 1.00 GHz		19		dB
Output Return Loss	DC - 0.50 GHz		12		dB
	0.50 - 1.00 GHz		11		dB
Reverse Isolation	DC - 1.0 GHz		23		dB
Output Power for 1 dB Compression (P1dB)	DC - 0.25 GHz	19	22		dBm
	0.25 - 0.50 GHz	17.5	20.5		dBm
	0.50 - 1.00 GHz	16	19		dBm
Output Third Order Intercept (IP3) ($P_{out} = 0 \text{ dBm}$ per tone, 1 MHz spacing)	DC - 0.25 GHz		37		dBm
	0.25 - 0.50 GHz		35		dBm
	0.50 - 1.00 GHz		33		dBm
Noise Figure	DC - 1.0 GHz		2.8		dB
Supply Current (I_{cc})			88	110	mA

Note: Data taken with broadband bias tee on device output.

For price, delivery and to place orders: Hittite Microwave Corporation, 20 Alpha Road, Chelmsford, MA 01824

Phone: 978-250-3343 Fax: 978-250-3373 Order On-line at www.hittite.com

Application Support: Phone: 978-250-3343 or apps@hittite.com

Broadband Gain & Return Loss

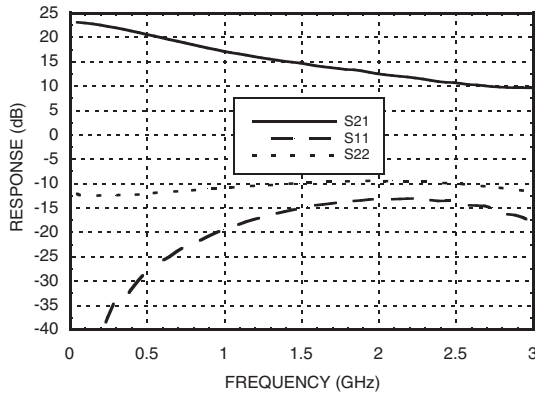

Gain vs. Temperature

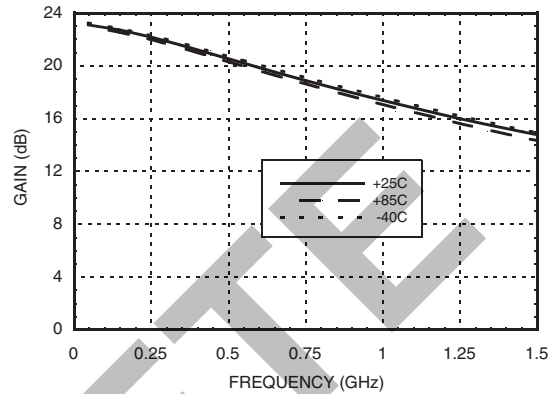

Input Return Loss vs. Temperature

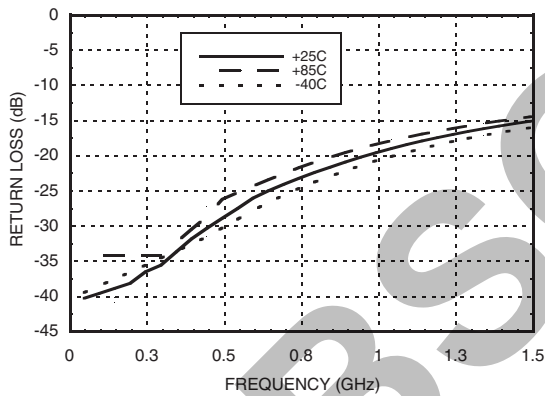

Output Return Loss vs. Temperature

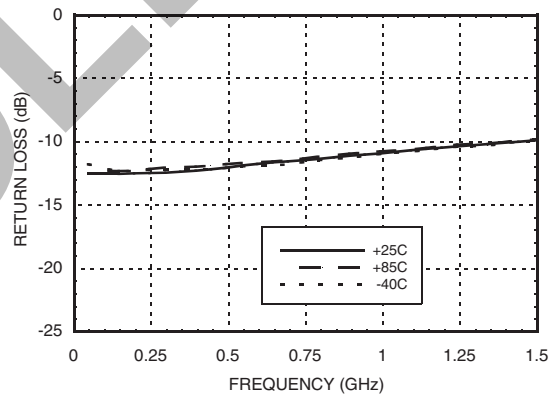

Reverse Isolation vs. Temperature

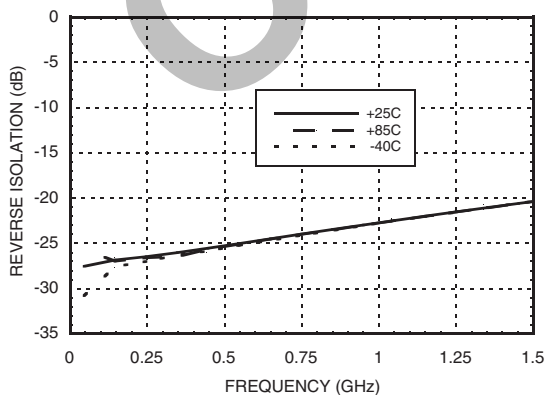

Noise Figure vs. Temperature

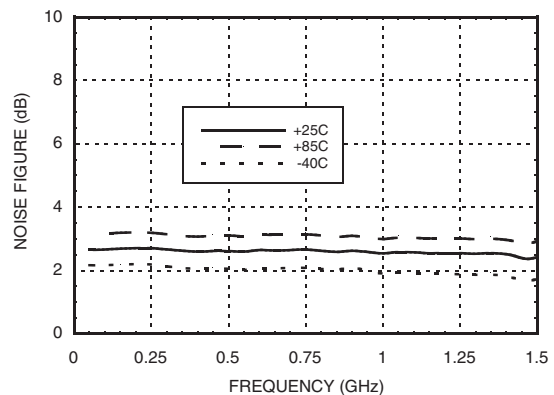

P1dB vs. Temperature

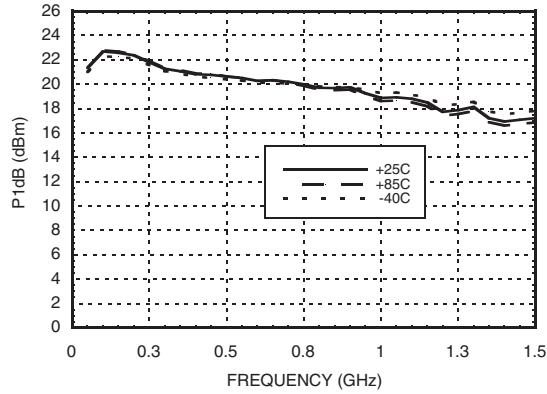

Psat vs. Temperature

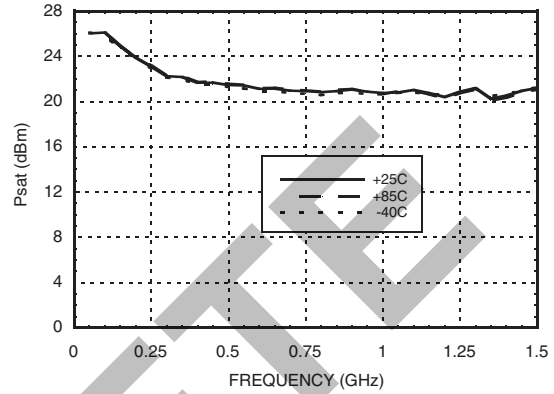

Output IP3 vs. Temperature

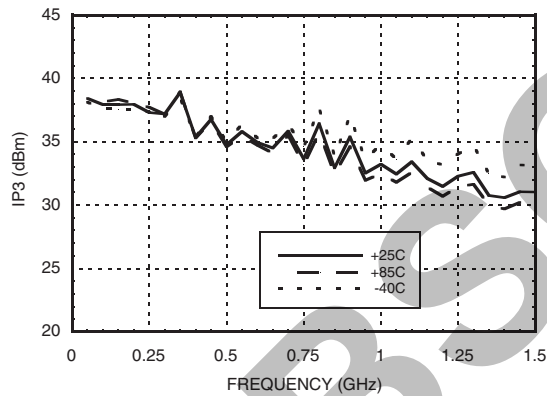

**Gain, Power & OIP3 vs. Supply Voltage
for Constant Icc = 88 mA @ 850 MHz**

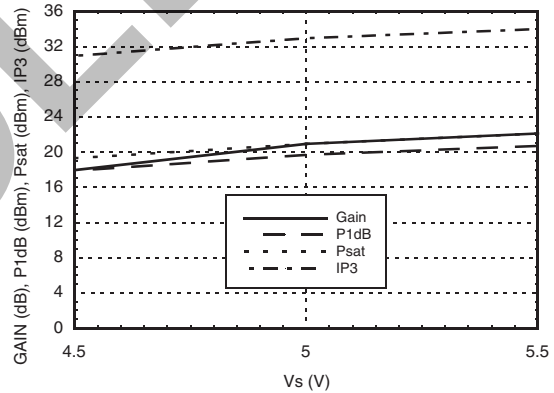

**Vcc vs. Icc Over Temperature for
Fixed Vs= 5V, RBIAS= 1.8 Ohms**

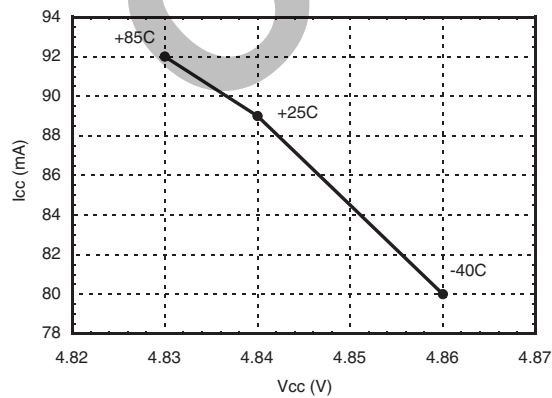

ACPR vs. Channel Output Power

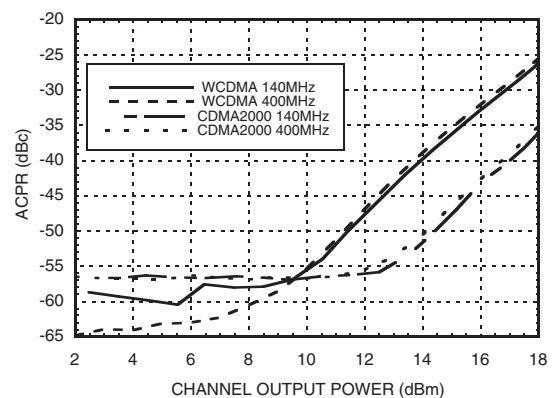

Absolute Maximum Ratings

Collector Bias Voltage (Vcc)	+5.5 Vdc
RF Input Power (RFIN)(Vcc = +4.2 Vdc)	+10 dBm
Junction Temperature	150 °C
Continuous Pdiss (T = 85 °C) (derate 9 mW/°C above 85 °C)	0.59 W
Thermal Resistance (junction to lead)	110 °C/W
Storage Temperature	-65 to +150 °C
Operating Temperature	-40 to +85 °C
ESD Sensitivity (HMB)	Class 1C



ELECTROSTATIC SENSITIVE DEVICE
OBSERVE HANDLING PRECAUTIONS

Outline Drawing

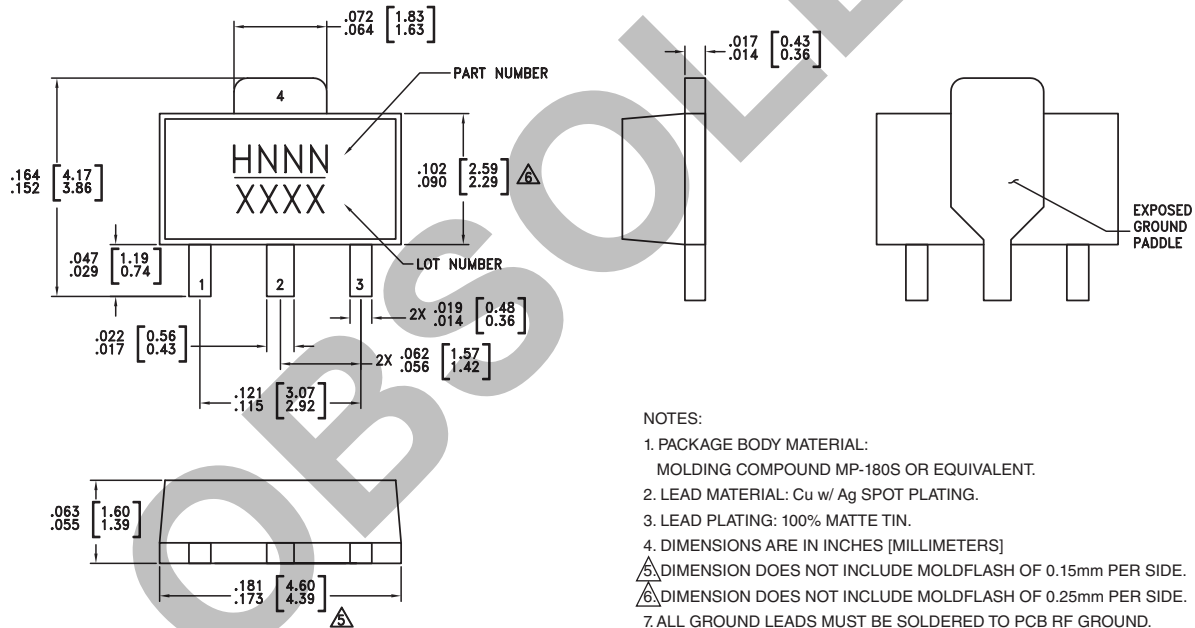

Package Information

Part Number	Package Body Material	Lead Finish	MSL Rating	Package Marking ^[3]
HMC580ST89	Low Stress Injection Molded Plastic	Sn/Pb Solder	MSL1 ^[1]	H580 XXXX
HMC580ST89E	RoHS-compliant Low Stress Injection Molded Plastic	100% matte Sn	MSL1 ^[2]	<u>H580</u> XXXX

[1] Max peak reflow temperature of 235 °C

[2] Max peak reflow temperature of 260 °C

[3] 4-Digit lot number XXXX

Pin Descriptions

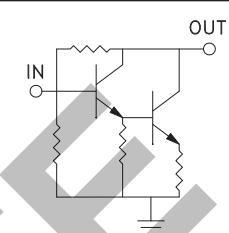
Pin Number	Function	Description	Interface Schematic
1	IN	This pin is DC coupled. An off chip DC blocking capacitor is required.	
3	OUT	RF output and DC Bias (Vcc) for the output stage.	
2, 4	GND	These pins and package bottom must be connected to RF/DC ground.	

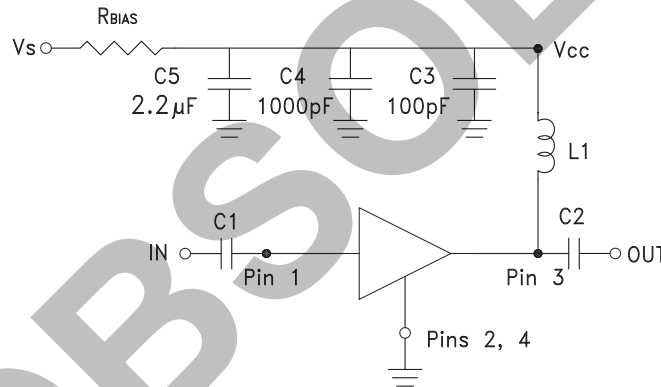
Application Circuit

Recommended Bias Resistor Values

 for $I_{cc} = 88 \text{ mA}$, $R_{bias} = (V_s - V_{cc}) / I_{cc}$, $V_s > +5V$

Supply Voltage (Vs)	6V	8V
R _{BIAS} VALUE	13 Ω	36 Ω
R _{BIAS} POWER RATING	¼ W	½ W

Note:

- External blocking capacitors are required on RFIN and RFOUT.
- R_{BIAS} provides DC bias stability over temperature.

Recommended Component Values for Key Application Frequencies with Vs = +5V

Component	Frequency (MHz)			
	50	250	400	900
L1	270 nH	110 nH	110 nH	56 nH
C1, C2	0.01 µF	820 pF	820 pF	100 pF
R _{bias}	0 Ohms	1.5 Ohms	1.5 Ohms	1.8 Ohms

For price, delivery and to place orders: Hittite Microwave Corporation, 20 Alpha Road, Chelmsford, MA 01824

 Phone: 978-250-3343 Fax: 978-250-3373 Order On-line at www.hittite.com

 Application Support: Phone: 978-250-3343 or apps@hittite.com

Evaluation PCB

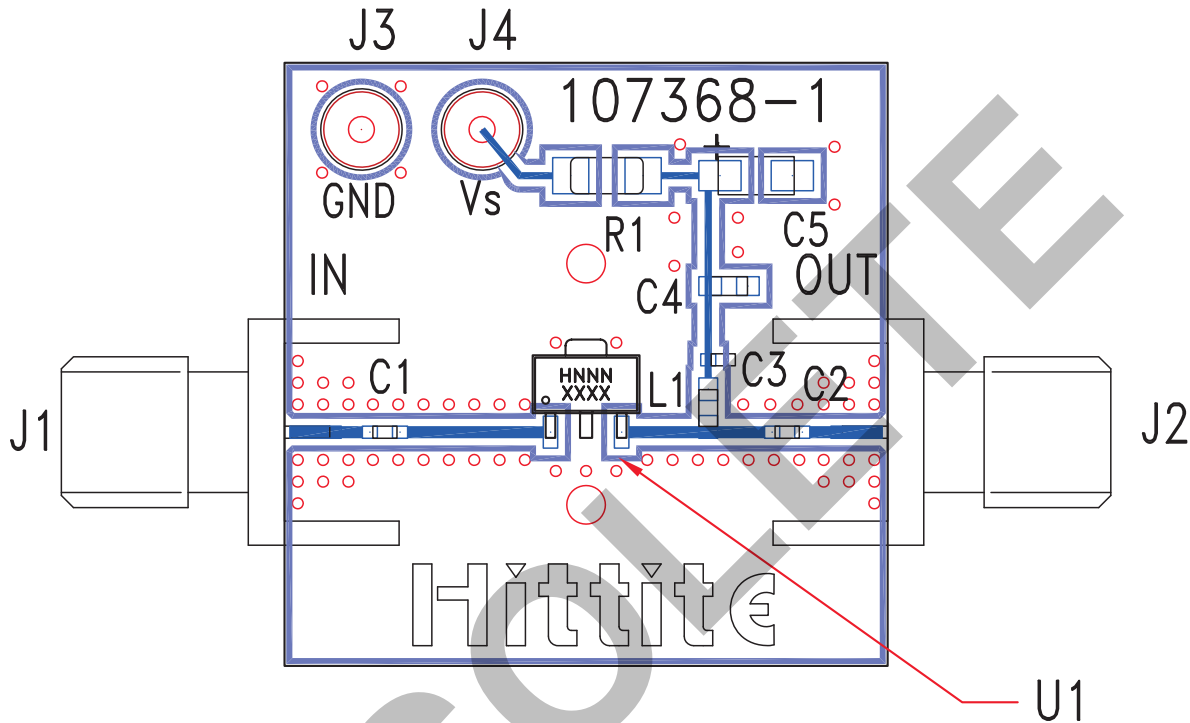

List of Materials for Evaluation PCB 116402 [1]

Item	Description
J1 - J2	PCB Mount SMA Connector
J3 - J4	DC Pin
C1, C2	Capacitor, 0402 Pkg.
C3	100 pF Capacitor, 0402 Pkg.
C4	1000 pF Capacitor, 0603 Pkg.
C5	2.2 μ F Capacitor, Tantalum
R1	Resistor, 1206 Pkg.
L1	Inductor, 0603 Pkg.
U1	HMC580ST89 / HMC580ST89E
PCB [2]	107368 Evaluation PCB

[1] Reference this number when ordering complete evaluation PCB

[2] Circuit Board Material: Rogers 4350

[3] Evaluation board tuned for 900 MHz operation

The circuit board used in the final application should use RF circuit design techniques. Signal lines should have 50 Ohm impedance while the package ground leads and package bottom should be connected directly to the ground plane similar to that shown. A sufficient number of via holes should be used to connect the top and bottom ground planes. The evaluation board should be mounted to an appropriate heat sink. The evaluation circuit board shown is available from Hittite upon request.

Looking for pricing, stock, or lifecycle information?

Click below to explore more details on WIN SOURCE:

 [View HMC580ST89E on WIN SOURCE](#)

 [Analog Devices Inc. Information](#)

Optimize Your Supply Chain with WIN SOURCE Solutions

-  Global Sourcing Solution
-  Obsolete Management
-  Cost Control Management
-  Shortage Management
-  Alternative Solution
-  Excess Inventory Management