



**THE DATASHEET OF
HMC497LP4E**





SiGe WIDEBAND DIRECT MODULATOR RFIC, 100 - 4000 MHz

Typical Applications

The HMC497LP4(E) is ideal for:

- UMTS, GSM or CDMA Basestations
- Fixed Wireless or WLL
- ISM Transceivers, 900 & 2400 MHz
- GMSK, QPSK, QAM, SSB Modulators

Features

- Very Low Noise Floor: -161 dBm/Hz
- Very High Linearity: +22 dBm OIP3
- High Output Power: +9 dBm Output P1dB
- High Modulation Accuracy
- DC - 700 MHz Baseband Input

Functional Diagram

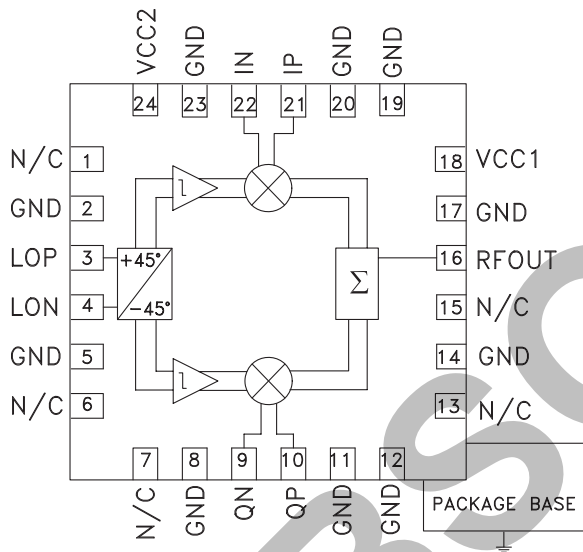

General Description

The HMC497LP4(E) is a low noise high linearity Direct Quadrature Modulator RFIC which is ideal for digital modulation applications from 100 - 4000 MHz including; Cellular/3G, Broadband Wireless Access & ISM circuits. Housed in a compact 4x4 mm (LP4) SMT QFN package, the RFIC requires minimal external components & provides a low cost alternative to more complicated double upconversion architectures. The RF output port is single-ended and matched to 50 Ohms with no external components. The LO requires -6 to +6 dBm and can be driven in either differential or single-ended mode while the baseband inputs will support modulation inputs from DC - 700 MHz typical. This device is optimized for a supply voltage of +4.5V to +5.5V and consumes 170 mA @ +5V supply.

Electrical Specifications, See Test Conditions on following page herein.

Parameter	Min.	Typ.	Max.	Min.	Typ.	Max.	Min.	Typ.	Max.	Min.	Typ.	Max.	Units
Frequency Range, RF		450 - 960		1700 - 2200			2200 - 2700			3400 - 4000			MHz
Output P1dB		+8		+8			+7			+6			dBm
Output Noise Floor		-161		-159			-157			-150			dBm/Hz
Output IP3		+22		+22			+20			+17			dBm
Output Power	+4	+6		+3	+5		+2	+5		0	+3		dBm
Carrier Feedthrough (uncalibrated)		-38		-36			-32			-30			dBm
Sideband Suppression (uncalibrated)		43		42			33			22			dBc
LO Port Return Loss		25		15			14			13			dB
RF Port Return Loss		11		20			17			11			dB

Information furnished by Analog Devices is believed to be accurate and reliable. However, no responsibility is assumed by Analog Devices for its use, nor for any infringements of patents or other rights of third parties that may result from its use. Specifications subject to change without notice. No license is granted by implication or otherwise under any patent or patent rights of Analog Devices. Trademarks and registered trademarks are the property of their respective owners.

For price, delivery, and to place orders: Analog Devices, Inc., One Technology Way, P.O. Box 9106, Norwood, MA 02062-9106 Phone: 781-329-4700 • Order online at www.analog.com Application Support: Phone: 1-800-ANALOG-D



SiGe WIDEBAND DIRECT MODULATOR RFIC, 100 - 4000 MHz

Electrical Specifications, (continued)

Parameter	Conditions	Min.	Typ.	Max.	Units
RF Output					
RF Frequency Range		100		4000	MHz
RF Return Loss			15		dB
LO Input					
LO Frequency Range		100		4000	MHz
LO Input Power		-6	0	+6	dBm
LO Port Return Loss			15		dB
Baseband Input Port					
Baseband Port Bandwidth	3 dB Bandwidth with 50Ω source.	DC		700	MHz
Baseband Input DC Voltage (Vbbdc)		+1.4	+1.5	+1.6	V
Baseband Input DC Bias Current (Ibbdc)	Single-ended.		90		μA
Single-ended Baseband Input Capacitance	De-embed to the lead of the device.		4.5		pF
DC Power Requirements See Test Conditions Below					
Supply Voltage (Vcc1, Vcc2)		+4.5	+5.0	+5.5	V
Supply Current (Icc1, Icc2)			168		mA

Test Conditions: Unless Otherwise Specified, the Following Test Conditions Were Used

Parameter	Condition
Temperature	+25 °C
Baseband Input Frequency	200 kHz
Baseband Input DC Voltage (Vbbdc)	+1.5V
Baseband Input AC Voltage (Peak to Peak Differential, I and Q)	1.6V
Baseband Input AC Voltage for OIP3 Measurement (Peak to Peak Differential, I and Q)	800 mV per tone @ 150 & 250 kHz
Frequency Offset for Output Noise Measurements	20 MHz
Supply (Vcc1, Vcc2)	+5.0V
LO Input Power	0 dBm
LO Input Mode	Single-Ended through LON
Mounting Configuration	Refer to HMC497LP4 Application Schematic Herein
Sideband & Carrier Feedthrough	Uncalibrated

Calibrated vs. Uncalibrated Test Results

During the Uncalibrated Sideband and Carrier Suppression tests, care is taken to ensure that the I/Q signal paths from the Vector Signal Generator (VSG) to the Device Under Test (DUT) are equal. The “Uncalibrated, +25 °C” Sideband and Carrier Suppression plots were measured at room temperature, while the “Uncalibrated, over Temperature” Sideband and Carrier Suppression plots represent the worst case uncalibrated suppression levels measured at T= -40 °C, +25 °C, and +85 °C.

The “Calibrated, + 25 °C” Sideband Suppression data was plotted after a manual adjustment of the I/Q amplitude balance and I/Q phase offset (skew) at +25 °C, and at each LO input power level. The +25 °C adjustment settings were held constant during tests over temperature. The “Calibrated, over Temperature” plots represent the worst case calibrated Sideband Suppression levels at T= -40 °C, +25 °C, and +85 °C.

The “Calibrated, +25 °C” Carrier Suppression data was plotted after a manual adjustment of the Ip/In & Qp/Qn DC offsets at +25 °C, and at each LO input power level. The +25 °C adjustment settings were held constant during tests over temperature. The “Calibrated, over Temperature” plots represent the worst case Carrier Suppression levels measured at T= -40 °C, +25 °C, and +85 °C.



SiGe WIDEBAND DIRECT MODULATOR RFIC, 100 - 4000 MHz

Output IP3, P1dB & Noise Floor @ 20 MHz Offset vs. Frequency

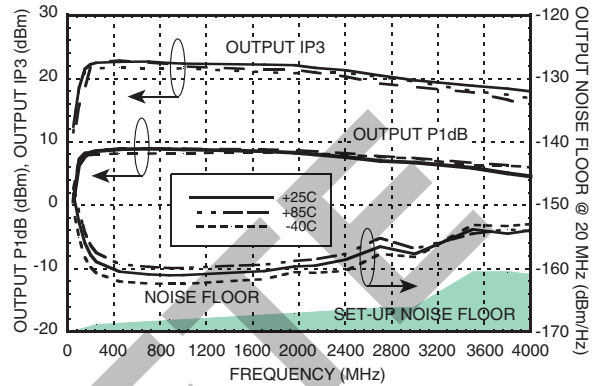

Wideband Performance vs. Frequency

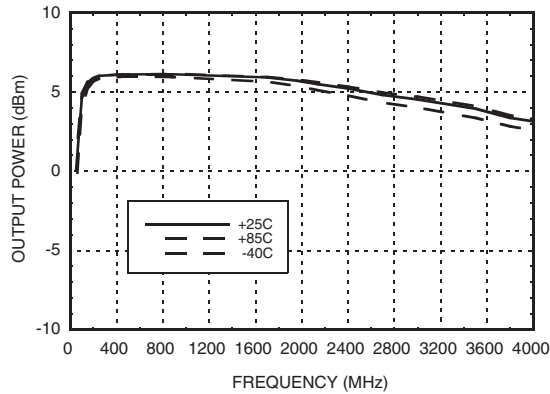

Uncalibrated Carrier Feedthrough vs. Frequency

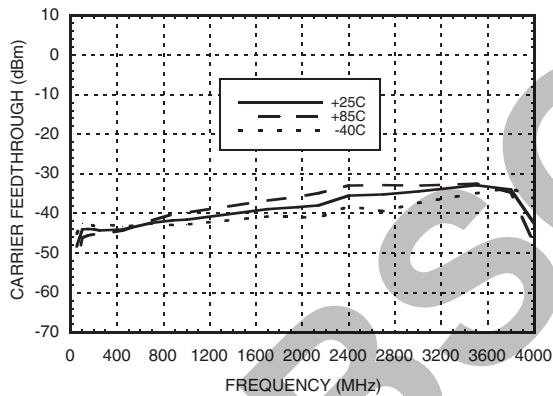

Calibrated Carrier Feedthrough vs. Frequency

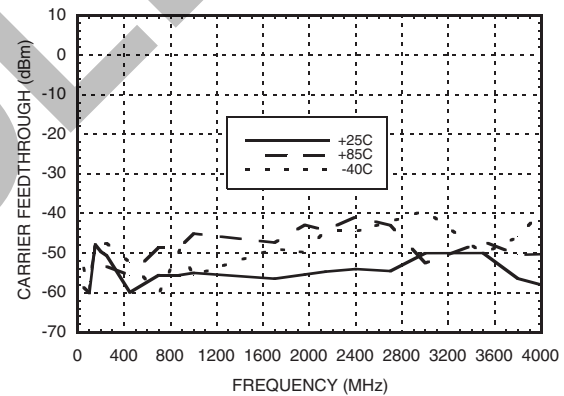

Sideband Suppression vs. Frequency

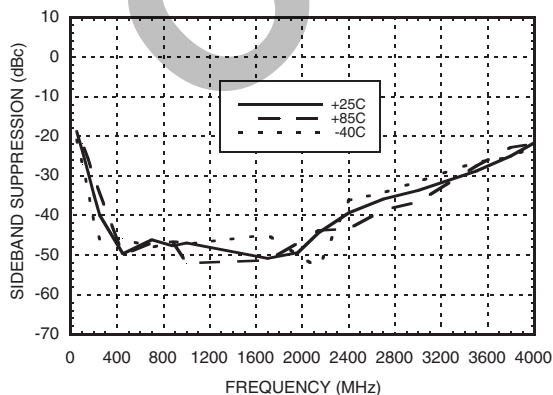

Return Loss vs. Frequency

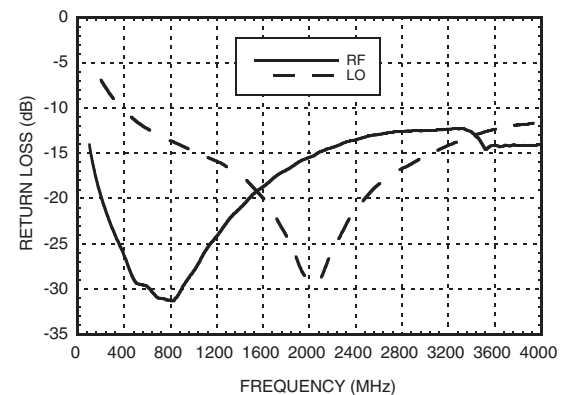

[1] See note titled "Calibrated vs. Uncalibrated test results" herein.



SiGe WIDEBAND DIRECT MODULATOR RFIC, 100 - 4000 MHz

Wideband Performance vs. Frequency Over LO Power [3]

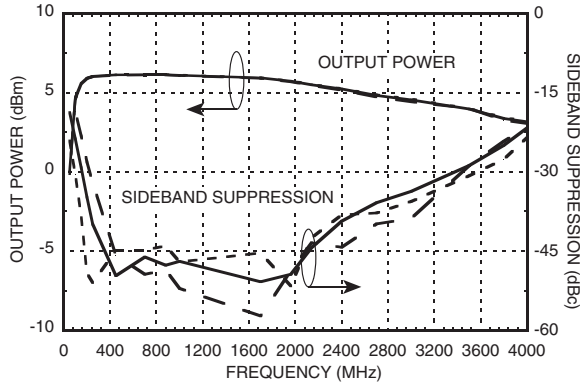

Output IP3, P1dB & Noise Floor @ 20 MHz Offset vs. Frequency Over LO Power [3]

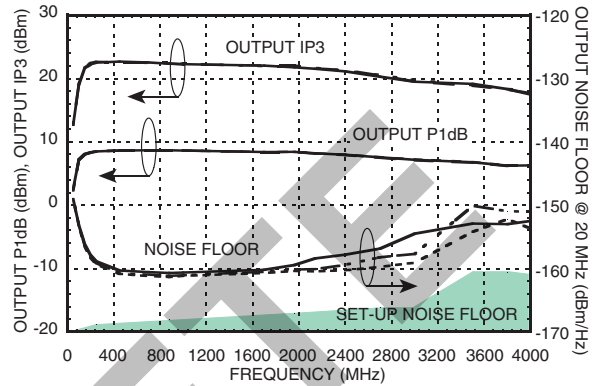

Uncalibrated Carrier Feedthrough vs. Frequency [2]

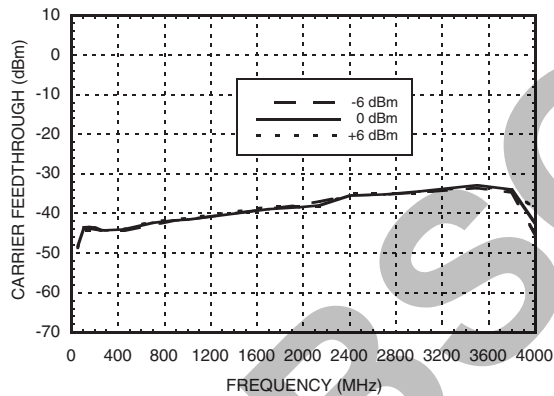

Calibrated Carrier Feedthrough vs. Frequency [2]

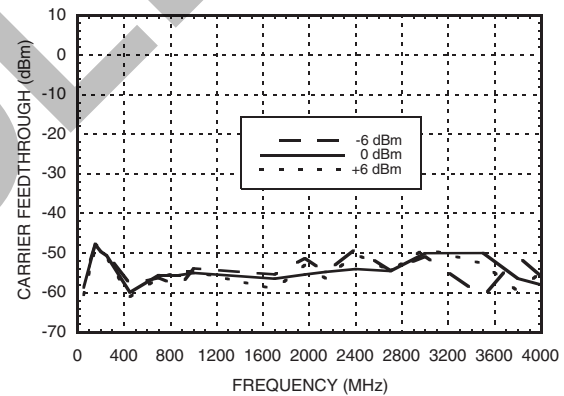

Wideband Performance vs. Frequency Over Supply Voltage [1]

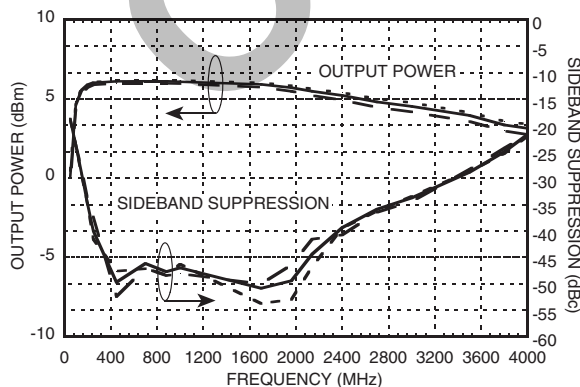

Output IP3, P1dB & Noise Floor @ 20 MHz vs. Offset Frequency Over Supply Voltage [1]

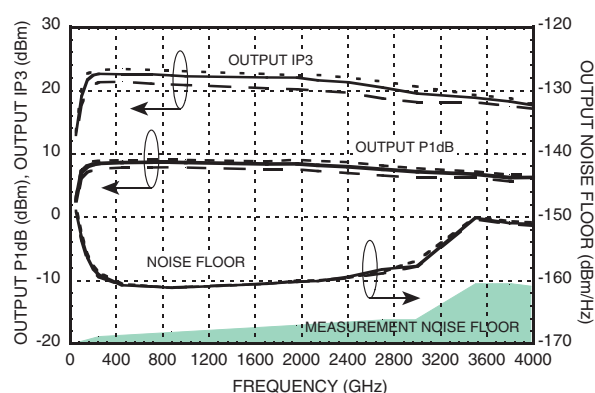

[1] See note titled "Calibrated vs. Uncalibrated test results" herein.

[2] Supply voltage from +4.5 to +5.5V.

[3] LO Power from -6 dBm to +6 dBm

Information furnished by Analog Devices is believed to be accurate and reliable. However, no responsibility is assumed by Analog Devices for its use, nor for any infringements of patents or other rights of third parties that may result from its use. Specifications subject to change without notice. No license is granted by implication or otherwise under any patent or patent rights of Analog Devices. Trademarks and registered trademarks are the property of their respective owners.

For price, delivery, and to place orders: Analog Devices, Inc., One Technology Way, P.O. Box 9106, Norwood, MA 02062-9106 Phone: 781-329-4700 • Order online at www.analog.com Application Support: Phone: 1-800-ANALOG-D



SiGe WIDEBAND DIRECT MODULATOR RFIC, 100 - 4000 MHz

ACPR & Output Noise for W-CDMA @ 2140 MHz

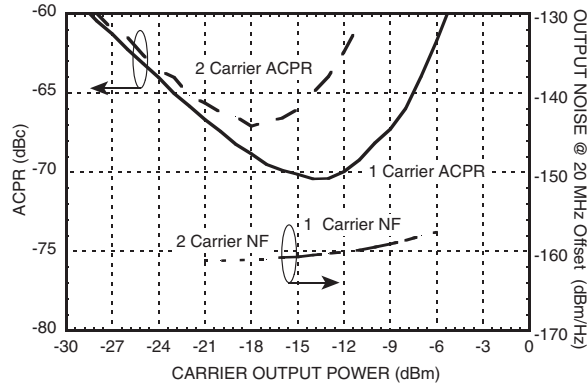

Output Noise @ 20 MHz Offset vs. LO Power Over Temperature

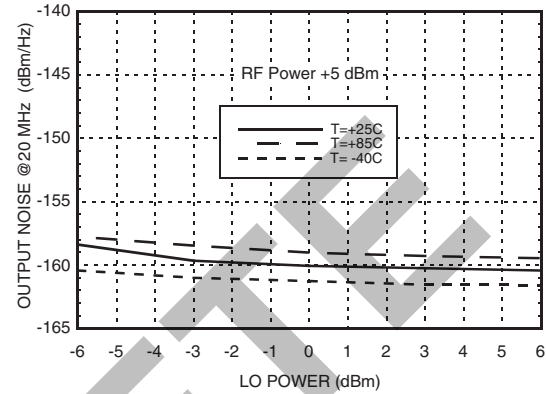

Compression Characteristic @ 2140 MHz

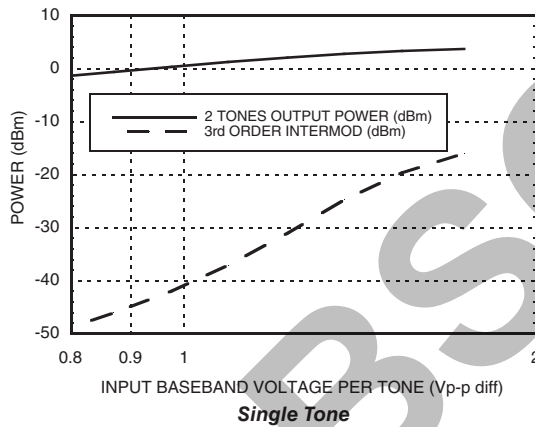

Power & Linearity @ 2140 MHz vs. Baseband Voltage

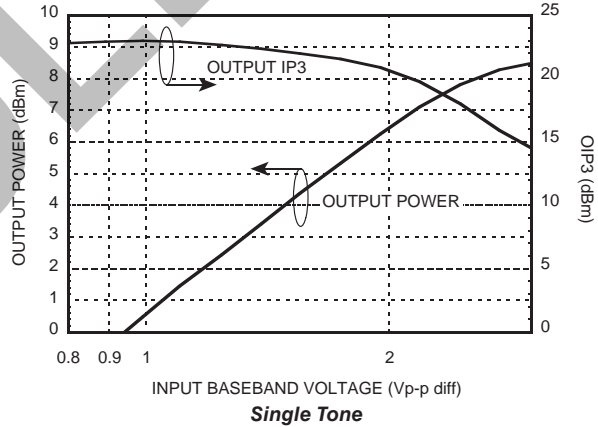

EVM vs. LO Harmonic Level & Sideband Rejection for EDGE @ 900 MHz

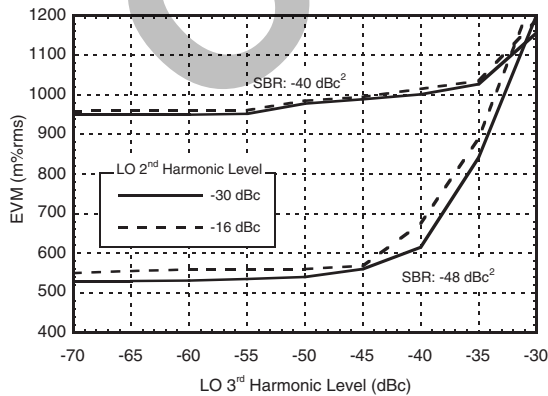

EVM vs. LO Harmonic Level & Sideband Rejection for EDGE @ 1900 MHz

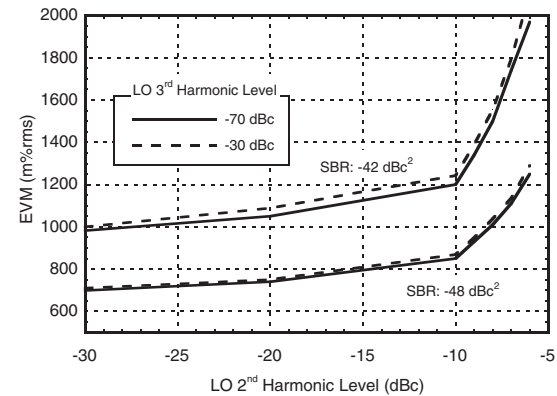

Note 1: W-CDMA (Modulation Set-up for ACPR Mode); The Baseband I and Q input signals were generated using "Test Model 1 with 64 channels" settings in the Agilent E3844C.

Note 2: The I/Q baseband amplitude and phase inputs were offset to achieve Sideband Rejection (SBR) levels. LO = +6 dBm, SSB Power = 0 dBm

Information furnished by Analog Devices is believed to be accurate and reliable. However, no responsibility is assumed by Analog Devices for its use, nor for any infringements of patents or other rights of third parties that may result from its use. Specifications subject to change without notice. No license is granted by implication or otherwise under any patent or patent rights of Analog Devices. Trademarks and registered trademarks are the property of their respective owners.

For price, delivery, and to place orders: Analog Devices, Inc., One Technology Way, P.O. Box 9106, Norwood, MA 02062-9106 Phone: 781-329-4700 • Order online at www.analog.com Application Support: Phone: 1-800-ANALOG-D

SiGe WIDEBAND DIRECT MODULATOR RFIC, 100 - 4000 MHz



Pin Descriptions

Pin Number	Function	Description	Interface Schematic
1, 6, 7, 13, 15	N/C	Not connected.	
2, 5, 8, 11, 12, 14, 17, 19, 20, 23	GND	These pins and the ground paddle should be connected to a high quality RF/DC ground.	
3, 4	LOP, LON	LO inputs. Need DC decoupling capacitors. The ports could be driven single ended or differentially.	
9, 10	QN, QP	Q channel differential baseband input. These high impedance ports should be biased around 1.5V DC. Nominal recommended baseband input is around 1.6V pp differential.	
16	RFOUT	RF output. 50 Ohms. Needs DC blocking capacitor.	
18	Vcc1	Supply voltage for the mixer and output stages 79mA @ +5.0V.	
21, 22	IP, IN	I channel differential baseband input. These high impedance ports should be at the same bias voltage (VbbDC) as Qn & Qp.	
24	Vcc2	Supply voltage for the LO stage 88mA @ +5V.	



Evaluation PCB

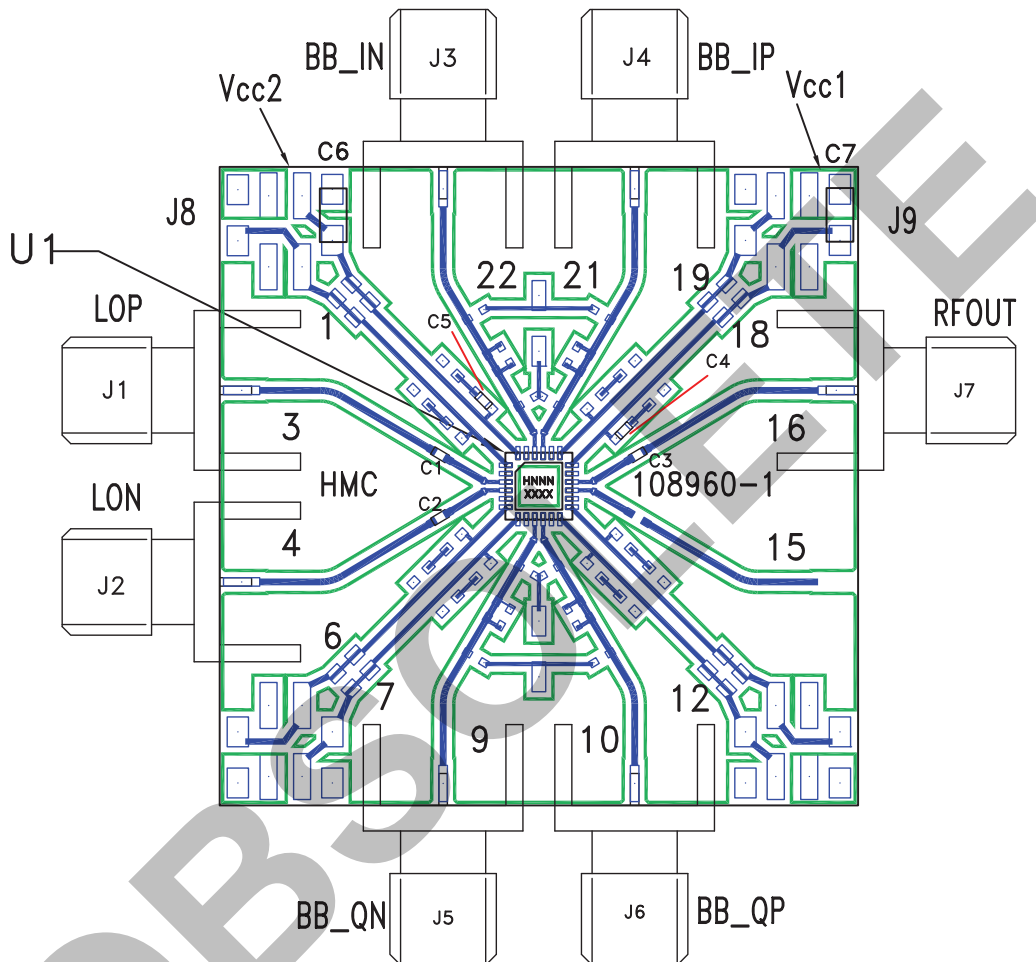

List of Materials for Evaluation PCB 108962 [1]

Item	Description
J1 - J7	PC Mount SMA Connector
J8, J9	DC Molex Connector
C1 - C3	100 pF Chip Capacitor, 0402 Pkg.
C4, C5	1000 pF Chip Capacitor, 0402 Pkg.
C6, C7	4.7 uF, Case A, Tantalum
U1	HMC497LP4 Modulator
PCB [2]	108960 Eval Board

[1] Reference this number when ordering complete evaluation PCB

[2] Circuit Board Material: Rogers 4350

The circuit board used in the final application should use RF circuit design techniques. Signal lines should have 50 ohm impedance while the package ground leads and exposed paddle should be connected directly to the ground plane similar to that shown. A sufficient number of via holes should be used to connect the top and bottom ground planes. The evaluation circuit board shown is available from Hittite upon request.



SiGe WIDEBAND DIRECT MODULATOR RFIC, 100 - 4000 MHz

Application & Evaluation PCB Schematic

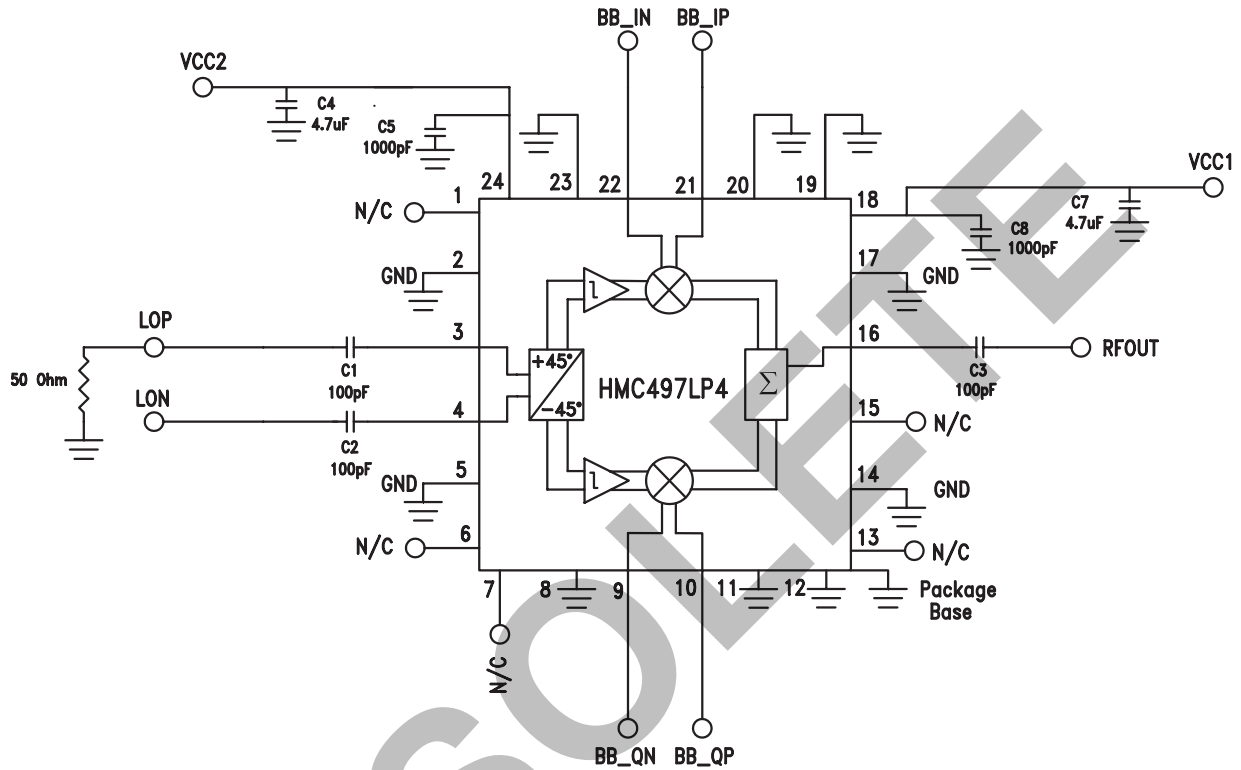

Characterization Set-up

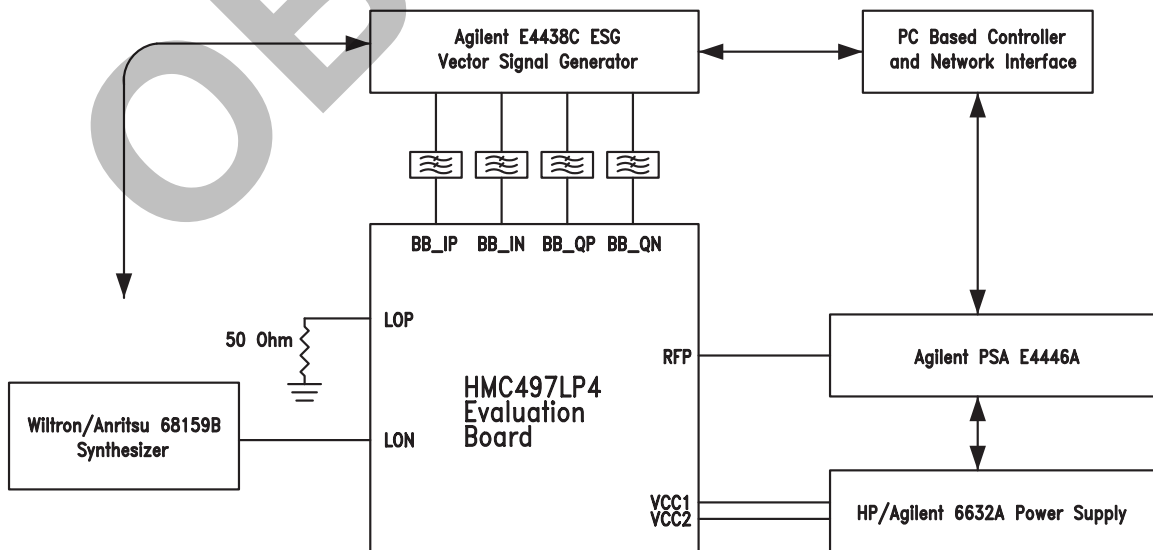

Information furnished by Analog Devices is believed to be accurate and reliable. However, no responsibility is assumed by Analog Devices for its use, nor for any infringements of patents or other rights of third parties that may result from its use. Specifications subject to change without notice. No license is granted by implication or otherwise under any patent or patent rights of Analog Devices. Trademarks and registered trademarks are the property of their respective owners.

For price, delivery, and to place orders: Analog Devices, Inc., One Technology Way, P.O. Box 9106, Norwood, MA 02062-9106 Phone: 781-329-4700 • Order online at www.analog.com Application Support: Phone: 1-800-ANALOG-D

**SiGe WIDEBAND DIRECT
MODULATOR RFIC, 100 - 4000 MHz****Notes:**

OBSOLETE

Looking for pricing, stock, or lifecycle information?

Click below to explore more details on WIN SOURCE:

 [View HMC497LP4E on WIN SOURCE](#)

 [Analog Devices Inc. Information](#)

Optimize Your Supply Chain with WIN SOURCE Solutions

-  Global Sourcing Solution
-  Obsolete Management
-  Cost Control Management
-  Shortage Management
-  Alternative Solution
-  Excess Inventory Management