



THE DATASHEET OF HMC472LP4ETR



Analog Devices Welcomes Hittite Microwave Corporation

NO CONTENT ON THE ATTACHED DOCUMENT HAS CHANGED

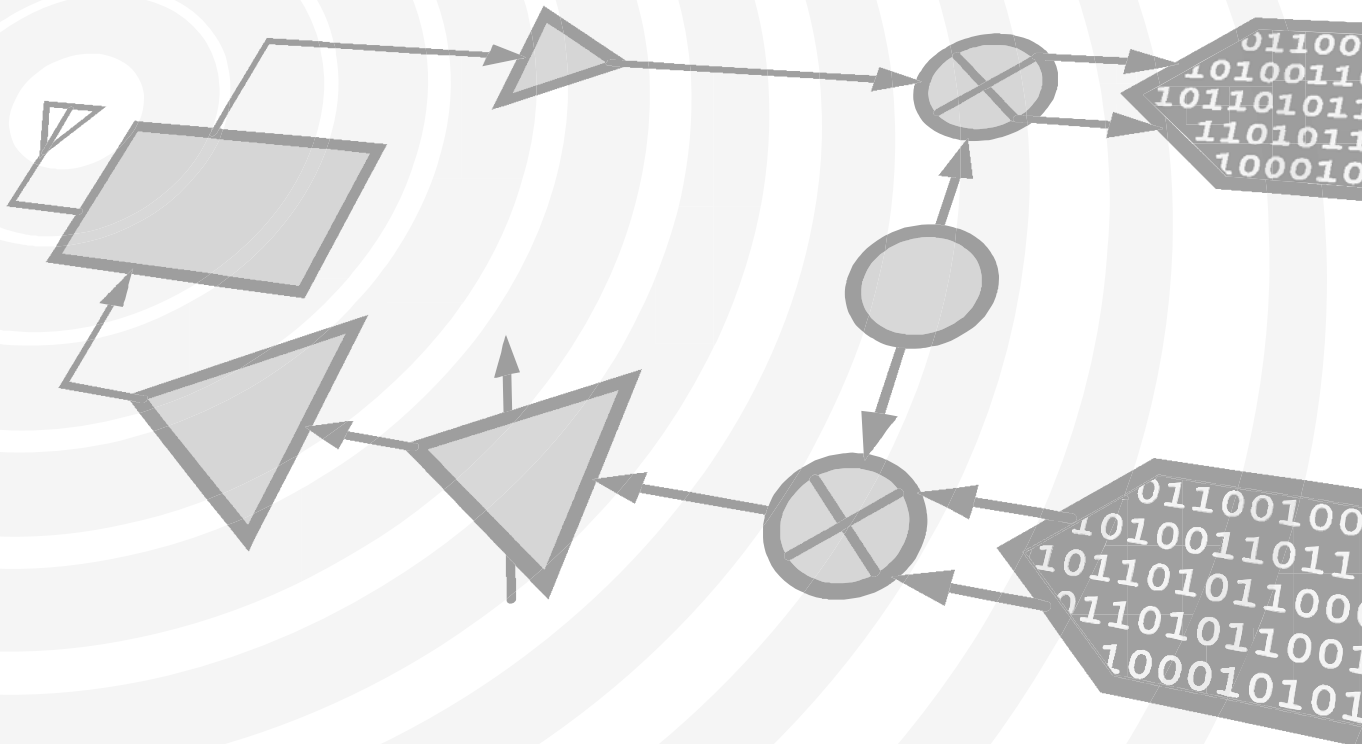

THIS PAGE INTENTIONALLY LEFT BLANK

Typical Applications

The HMC472LP4(E) is ideal for:

- 3G Infrastructure & access points
- Cellular/3G, LTE & UMB
- WiMAX, WiBN & Fixed Wireless
- Test Equipment and Sensors
- GSM, WCDMA & TD-SCDMA

Features

- 0.5 dB LSB Steps to 31.5 dB
- Single Control Line Per Bit
- TTL/CMOS Compatible Control
- ± 0.25 dB Typical Step Error
- Single +5V Supply
- 24 Lead Ceramic 4x4mm SMT Package: 16mm²
- Included in the HMC-DK004 Designer's Kit

Functional Diagram

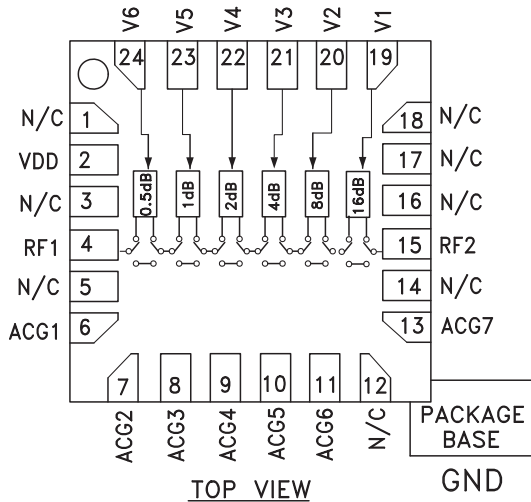

General Description

The HMC472LP4 & HMC472LP4E are broadband 6-bit GaAs IC digital attenuators in low cost leadless surface mount packages. This single positive control line per bit digital attenuator incorporates off chip AC ground capacitors for near DC operation, making it suitable for a wide variety of RF and IF applications. Covering DC to 3.8 GHz, the insertion loss is less than 2.0 dB typical. The attenuator bit values are 0.5 (LSB), 1, 2, 4, 8, and 16 dB for a total attenuation of 31.5 dB. Attenuation accuracy is excellent at ± 0.25 dB typical step error with an IIP3 of +45 dBm. Six TTL/CMOS control inputs are used to select each attenuation state. A single Vdd bias of +5V is required.

Electrical Specifications,

$T_A = +25^\circ\text{C}$, With $V_{dd} = +5\text{V}$ & $V_{ctl} = 0/+5\text{V}$ (Unless Otherwise Noted)

Parameter	Frequency (GHz)	Min.	Typ.	Max.	Units
Insertion Loss	DC - 1.5 GHz		1.5	1.8	dB
	1.5 - 3.0 GHz		2.0	2.3	dB
	3.0 - 3.8 GHz		2.3	3	dB
Attenuation Range	DC - 3.8 GHz		31.5		dB
Return Loss (RF1 & RF2, All Atten. States)	DC - 3.8 GHz		15		dB
Attenuation Accuracy: (Referenced to Insertion Loss)					
All Attenuation States	DC - 1.0 GHz	$\pm (0.20 + 3\% \text{ of Atten. Setting}) \text{ Max.}$			dB
0.5 - 3.5 dB States	1.0 - 2.2 GHz	$\pm (0.25 + 3\% \text{ of Atten. Setting}) \text{ Max.}$			dB
4.0 - 31.5 dB States	1.0 - 2.2 GHz	$\pm (0.15 + 4\% \text{ of Atten. Setting}) \text{ Max.}$			dB
All Attenuation States	2.2 - 3.0 GHz	$\pm (0.30 + 3\% \text{ of Atten. Setting}) \text{ Max.}$			dB
All Attenuation States	3.0 - 3.8 GHz	$\pm (0.35 + 5\% \text{ of Atten. Setting}) \text{ Max.}$			dB
Input Power for 0.1 dB Compression	0.1 - 3.8 GHz		20		dBm
Input Third Order Intercept Point (Two-Tone Input Power= 0 dBm Each Tone)	0.1 - 3.8 GHz	REF - 15.5 dB States	45		dBm
		16.0 - 31.5 dB States	35		dBm
Switching Characteristics					
tRISE, tFALL (10/90% RF)	DC - 3.8 GHz		130		ns
tON, tOFF (50% CTL to 10/90% RF)			140		ns

0.5 dB LSB GaAs MMIC 6-BIT DIGITAL POSITIVE CONTROL ATTENUATOR, DC - 3.8 GHz



Insertion Loss

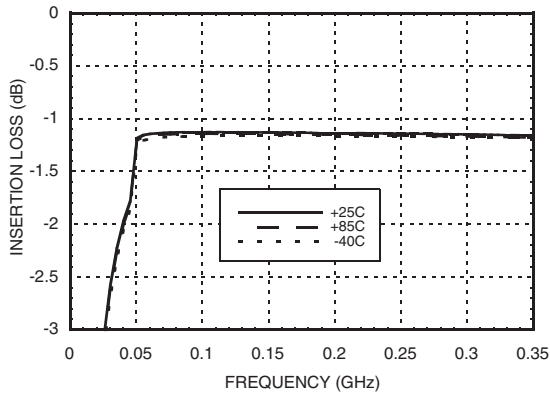

Insertion Loss

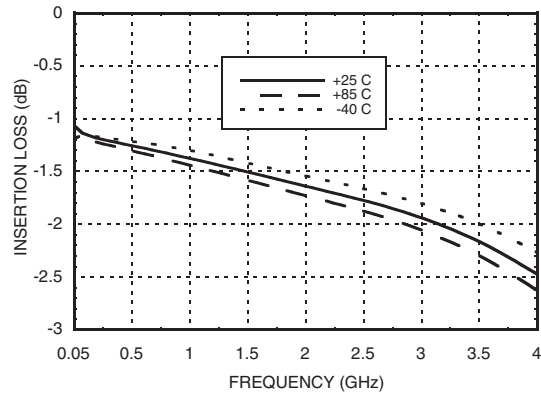

Return Loss RF1, RF2

(Only Major States are Shown)

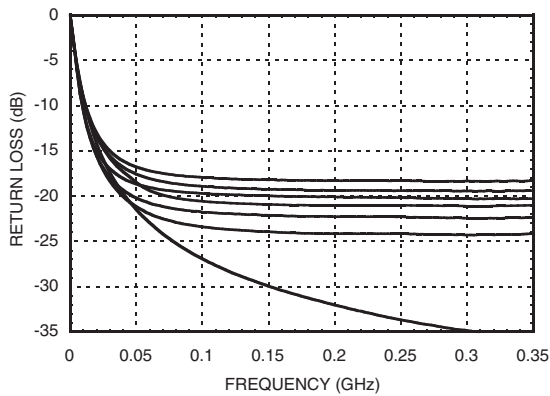

Return Loss RF1, RF2

(Only Major States are Shown)

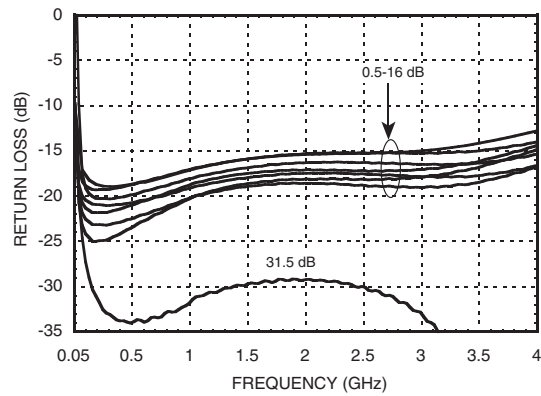

Normalized Attenuation

(Only Major States are Shown)

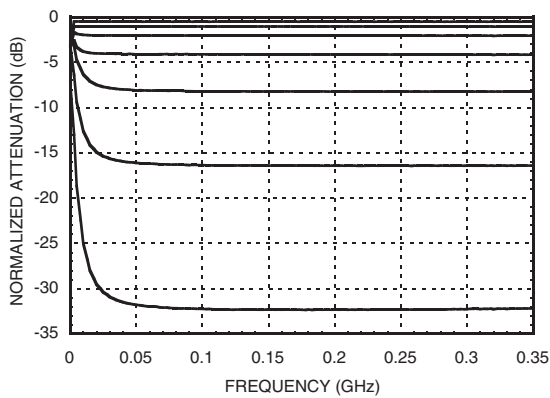

Normalized Attenuation

(Only Major States are Shown)

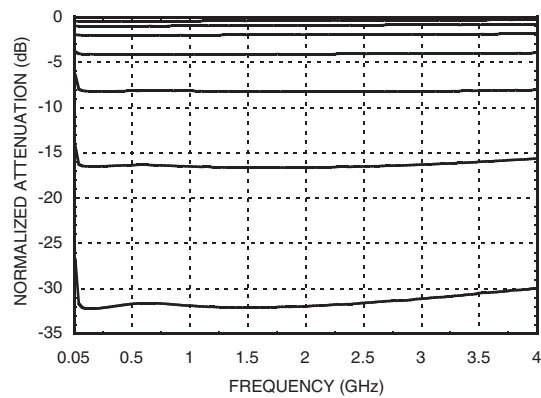



0.5 dB LSB GaAs MMIC 6-BIT DIGITAL POSITIVE CONTROL ATTENUATOR, DC - 3.8 GHz

Bit Error vs. Attenuation State

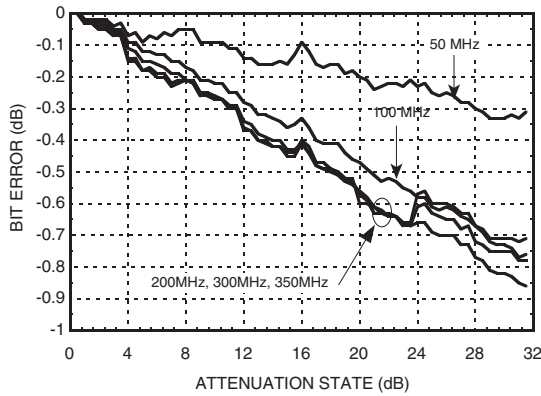

Bit Error vs. Attenuation State

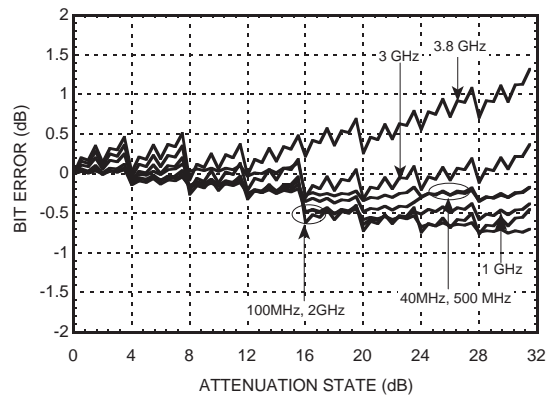

Bit Error vs. Frequency
(Only Major States are Shown)

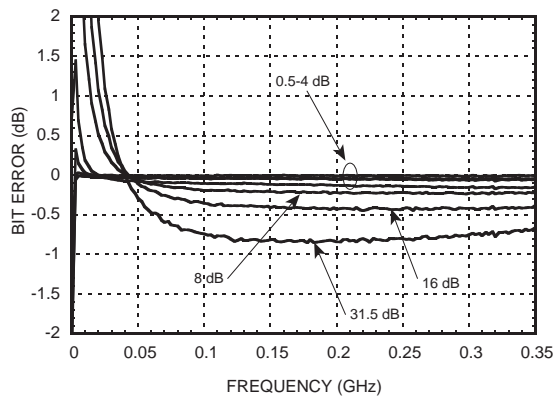

Bit Error vs. Frequency
(Only Major States are Shown)

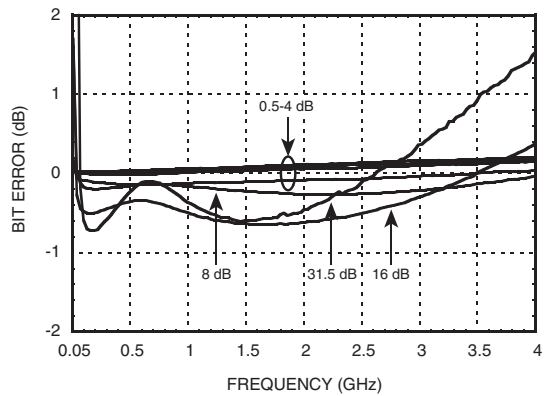

Bit Error vs. Frequency without AC Ground Caps
(Only Major States are Shown)

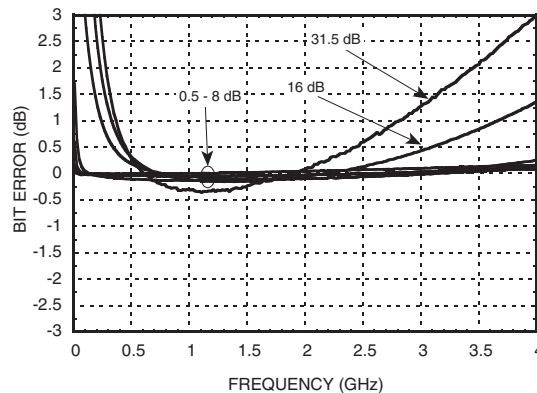



0.5 dB LSB GaAs MMIC 6-BIT DIGITAL POSITIVE CONTROL ATTENUATOR, DC - 3.8 GHz

Relative Phase vs. Frequency
(Only Major States are Shown)

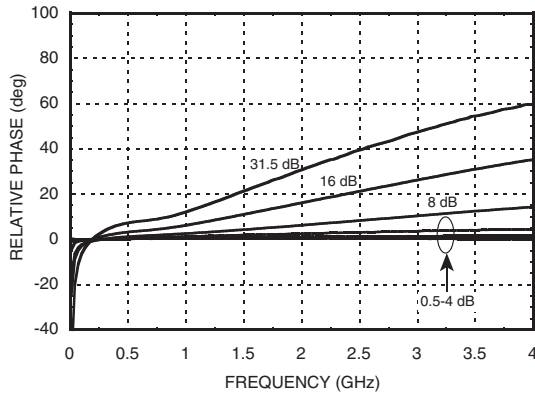

Worst Case Step Error Between Successive Attenuation States

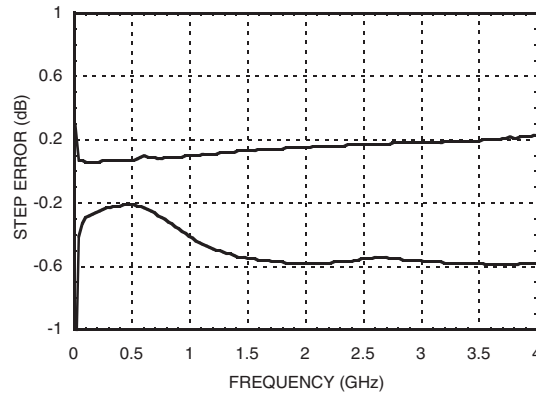

Bias Voltage & Current

Vdd = +5V ± 10%	
Vdd (V)	Idd (Typ.) (mA)
+4.5	4.7
+5.0	5.0
+5.5	5.3

Control Voltage

State	Bias Condition
Low	0 to +0.8 Vdc @ -5 uA Typ.
High	+ 2.0 to + 5.0 Vdc @ 40 uA Typ.

Note: Vdd = +5V

Truth Table

Control Voltage Input						Attenuation State RF1 - RF2
V1 16 dB	V2 8 dB	V3 4 dB	V4 2 dB	V5 1 dB	V6 0.5 dB	
High	High	High	High	High	High	Reference I.L.
High	High	High	High	High	Low	0.5 dB
High	High	High	High	Low	High	1 dB
High	High	High	Low	High	High	2 dB
High	High	Low	High	High	High	4 dB
High	Low	High	High	High	High	8 dB
Low	High	High	High	High	High	16 dB
Low	Low	Low	Low	Low	Low	31.5 dB

Any combination of the above states will provide an attenuation approximately equal to the sum of the bits selected.

Absolute Maximum Ratings

RF Input Power (DC - 3 GHz)	+27 dBm (T = +85 °C)
Control Voltage Range (V1 to V6)	-1V to Vdd +1V
Bias Voltage (Vdd)	+7V
Channel Temperature	150 °C
Continuous Pdiss (T = 85 °C) (derate 7.7 mW/°C above 85 °C)	0.5 W
Thermal Resistance	130 °C/W
Storage Temperature	-65 to +150 °C
Operating Temperature	-40 to +85 °C



ELECTROSTATIC SENSITIVE DEVICE
OBSERVE HANDLING PRECAUTIONS

Outline Drawing

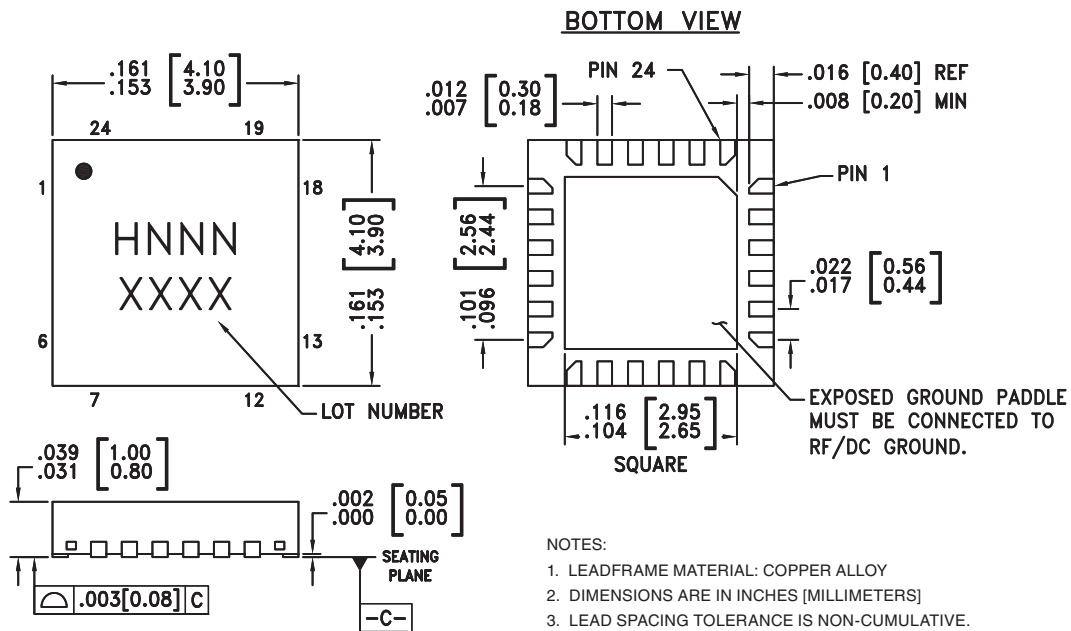

NOTES:

1. LEADFRAME MATERIAL: COPPER ALLOY
2. DIMENSIONS ARE IN INCHES [MILLIMETERS]
3. LEAD SPACING TOLERANCE IS NON-CUMULATIVE.
4. PAD BURR LENGTH SHALL BE 0.15mm MAXIMUM.
PAD BURR HEIGHT SHALL BE 0.05mm MAXIMUM.
5. PACKAGE WARP SHALL NOT EXCEED 0.05mm.
6. ALL GROUND LEADS AND GROUND PADDLE MUST BE SOLDERED TO PCB RF GROUND.
7. REFER TO HITTITE APPLICATION NOTE FOR SUGGESTED LAND PATTERN.

Package Information

Part Number	Package Body Material	Lead Finish	MSL Rating	Package Marking ^[3]
HMC472LP4	Low Stress Injection Molded Plastic	Sn/Pb Solder	MSL1 ^[1]	H472 XXXX
HMC472LP4E	RoHS-compliant Low Stress Injection Molded Plastic	100% matte Sn	MSL1 ^[2]	H472 XXXX

[1] Max peak reflow temperature of 235 °C



[2] Max peak reflow temperature of 260 °C

[3] 4-Digit lot number XXXX

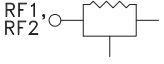
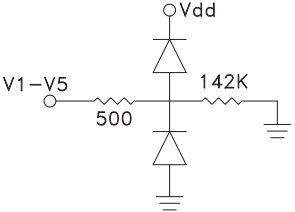

**0.5 dB LSB GaAs MMIC 6-BIT DIGITAL
POSITIVE CONTROL ATTENUATOR, DC - 3.8 GHz**

Pin Descriptions

Pin Number	Function	Description	Interface Schematic
1, 3, 5, 12, 14, 16, 17, 18	N/C	These pins should be connected to PCB RF ground to maximize performance.	
2	Vdd	Supply Voltage.	
4, 15	RF1, RF2	This pin is DC coupled and matched to 50 Ohm. Blocking capacitors are required. Select value based on lowest frequency of operation.	
6 - 11, 13	ACG1 - ACG7	External capacitors to ground are recommended for low and high frequency operation. Select value for lowest frequency of operation. Place capacitor as close to pins as possible. For operation from 700 to 2700 MHz, these pins may be left unconnected.	
19 - 24	V1 - V6	See truth table and control voltage table.	
	GND	Package bottom has an exposed metal paddle that must also be connected to RF/DC Ground.	



0.5 dB LSB GaAs MMIC 6-BIT DIGITAL POSITIVE CONTROL ATTENUATOR, DC - 3.8 GHz

5

ATTENUATORS - DIGITAL - SMT

Application Circuit

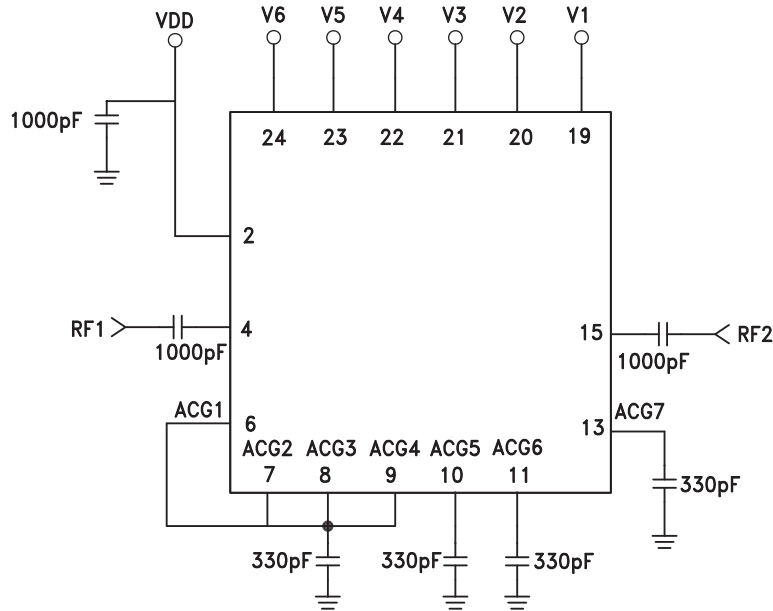

Note: For operations from 700 to 2700 MHz, pins 6 through 13 may be left unconnected.

Evaluation PCB

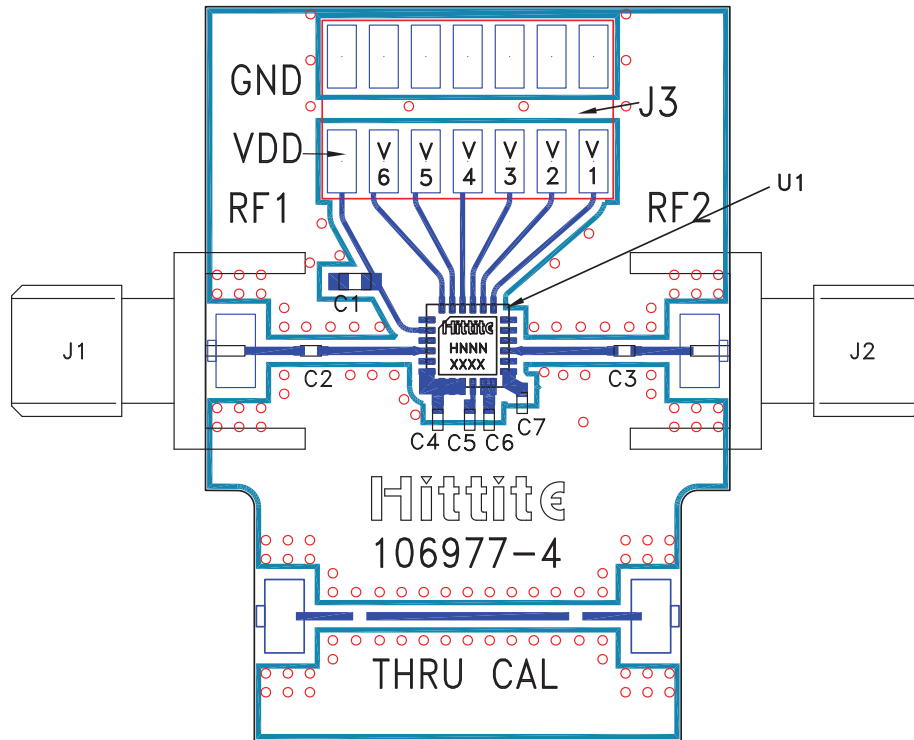

List of Materials for Evaluation PCB 107010 [1]

Item	Description
J1 - J2	PCB Mount SMA Connector
J3	14 Pin DC Connector
C1	1000 pF Capacitor, 0603 Pkg.
C2, C3	1000 pF Capacitor, 0402 Pkg.
C4 - C7	330 pF Capacitor, 0402 Pkg.
U1	HMC472LP4 / HMC472LP4E Digital Attenuator
PCB [2]	106977 Evaluation PCB

[1] Reference this number when ordering complete evaluation PCB

[2] Circuit Board Material: Rogers 4350

The circuit board used in the final application should use RF circuit design techniques. Signal lines should have 50 ohm impedance while the package ground leads and exposed paddle should be connected directly to the ground plane similar to that shown. A sufficient number of via holes should be used to connect the top and bottom ground planes. The evaluation circuit board shown is available from Hittite upon request.

Looking for pricing, stock, or lifecycle information?

Click below to explore more details on WIN SOURCE:

- ⊖ [View HMC472LP4ETR on WIN SOURCE](#)
- ⊖ [Analog Devices Inc. Information](#)

Optimize Your Supply Chain with WIN SOURCE Solutions

- ✓ Global Sourcing Solution
- ✓ Obsolete Management
- ✓ Cost Control Management
- ✓ Shortage Management
- ✓ Alternative Solution
- ✓ Excess Inventory Management