



**THE DATASHEET OF
HMC375LP3E**





GaAs PHEMT MMIC LOW NOISE AMPLIFIER, 1.7 - 2.2 GHz

7

AMPLIFIERS - LOW NOISE - SMT

Typical Applications

The HMC375LP3 / HMC375LP3E is ideal for basestation receivers:

- GSM, GPRS & EDGE
- CDMA & W-CDMA
- DECT

Features

- Noise Figure: 0.9 dB
- Output IP3: +34 dBm
- Gain: 17 dB
- Very Stable Gain vs. Supply & Temperature
- Single Supply: +5V @ 136 mA
- 50 Ohm Matched Output

Functional Diagram

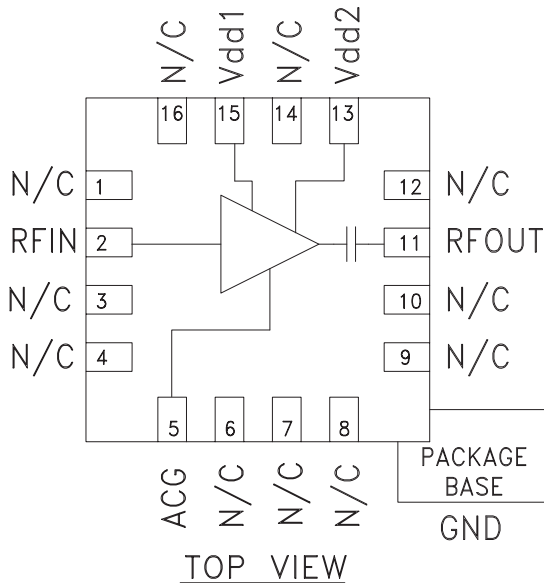

General Description

The HMC375LP3 & HMC375LP3E high dynamic range GaAs PHEMT MMIC Low Noise Amplifiers are ideal for GSM & CDMA cellular basestation front-end receivers operating between 1.7 and 2.2 GHz. This LNA has been optimized to provide 0.9 dB noise figure, 17 dB gain and +33 dBm output IP3 from a single supply of +5V @ 136mA. Input and output return losses are 14 dB typical with the LNA requiring minimal external components to optimize the RF input match, RF ground and DC bias. For applications which require improved noise figure, please see the HMC618LP3(E).

Electrical Specifications, $T_A = +25^\circ C$, $V_s = +5V$

Parameter	Min.	Typ.	Max.	Min.	Typ.	Max.	Min.	Typ.	Max.	Min.	Typ.	Max.	Units
Frequency Range	1.8 - 1.9			1.9 - 2.0			2.0 - 2.1			2.1 - 2.2			GHz
Gain	16.5	18.5		15.5	17.5		15	17		13	15		dB
Gain Variation Over Temperature		0.014	0.021		0.014	0.021		0.014	0.021		0.014	0.021	dB/°C
Noise Figure		1.0	1.35		0.95	1.2		0.9	1.2		0.9	1.3	dB
Input Return Loss		12			13			14			15		dB
Output Return Loss		13			16			11			8		dB
Reverse Isolation		35			34			34			34		dB
Output Power for 1dB Compression (P1dB)	16	18.5		16	18.5		15	18		14.5	17.5		dBm
Saturated Output Power (P _{sat})		19.5			19.5			19.5			19.5		dBm
Output Third Order Intercept (IP3) (-20 dBm Input Power per tone, 1 MHz tone spacing)		34			33.5			33			32.5		dBm
Supply Current (I _{dd})		136			136			136			136		mA

Information furnished by Analog Devices is believed to be accurate and reliable. However, no responsibility is assumed by Analog Devices for its use, nor for any infringements of patents or other rights of third parties that may result from its use. Specifications subject to change without notice. No license is granted by implication or otherwise under any patent or patent rights of Analog Devices. Trademarks and registered trademarks are the property of their respective owners.

For price, delivery, and to place orders: Analog Devices, Inc., One Technology Way, P.O. Box 9106, Norwood, MA 02062-9106 Phone: 781-329-4700 • Order online at www.analog.com Application Support: Phone: 1-800-ANALOG-D



**GaAs PHEMT MMIC LOW NOISE
AMPLIFIER, 1.7 - 2.2 GHz**

Broadband Gain & Return Loss

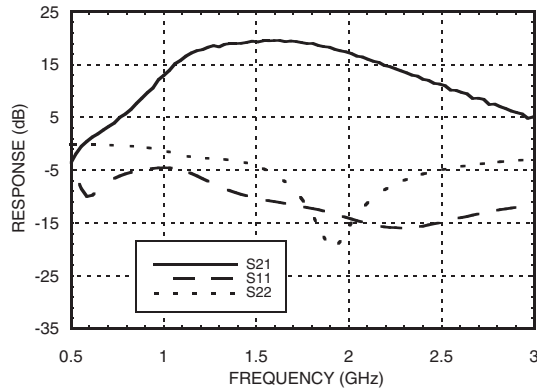

Noise Figure vs. Temperature

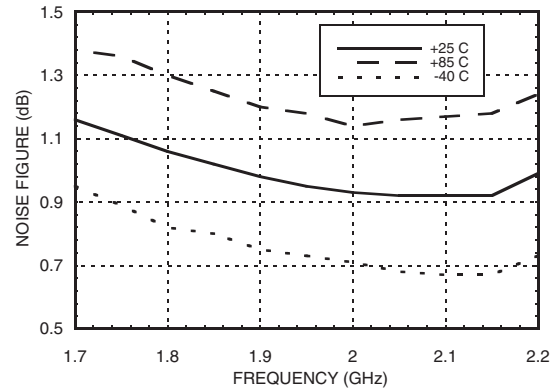

Gain vs. Temperature

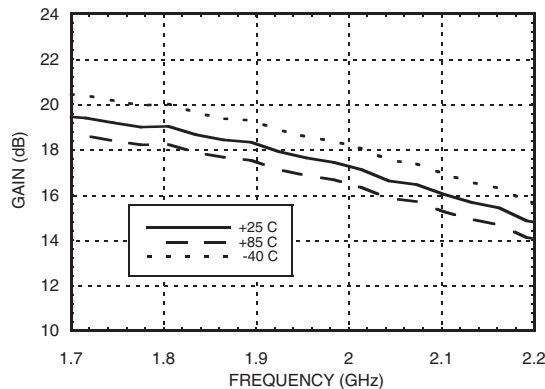

Noise Figure vs. Vdd

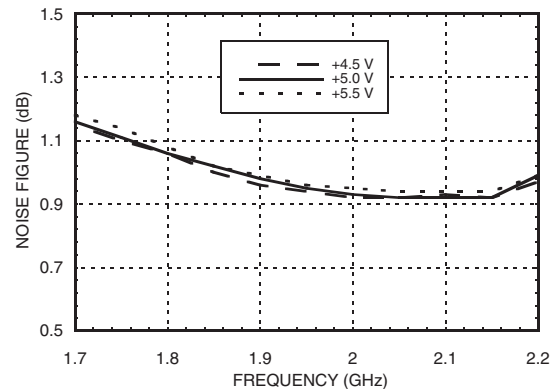

Gain vs. Vdd

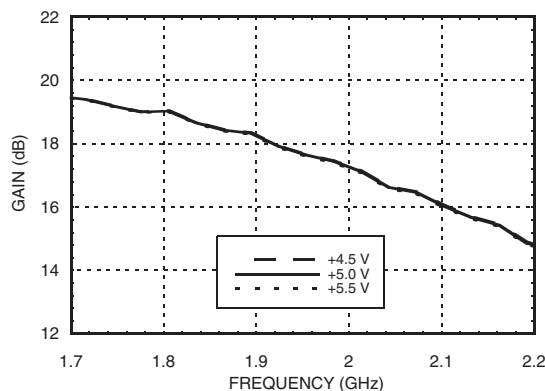

Reverse Isolation vs. Temperature

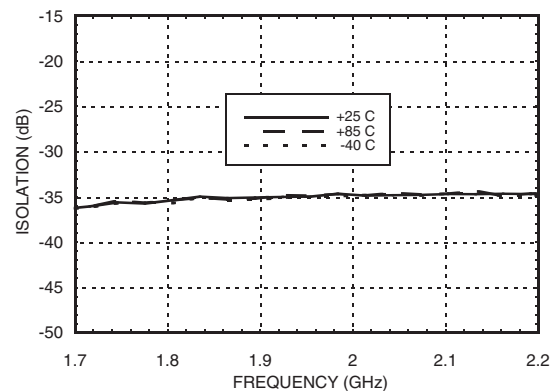

Information furnished by Analog Devices is believed to be accurate and reliable. However, no responsibility is assumed by Analog Devices for its use, nor for any infringements of patents or other rights of third parties that may result from its use. Specifications subject to change without notice. No license is granted by implication or otherwise under any patent or patent rights of Analog Devices. Trademarks and registered trademarks are the property of their respective owners.

For price, delivery, and to place orders: Analog Devices, Inc., One Technology Way, P.O. Box 9106, Norwood, MA 02062-9106 Phone: 781-329-4700 • Order online at www.analog.com Application Support: Phone: 1-800-ANALOG-D

GaAs PHEMT MMIC LOW NOISE AMPLIFIER, 1.7 - 2.2 GHz



7

AMPLIFIERS - LOW NOISE - SMT

Input Return Loss vs. Temperature

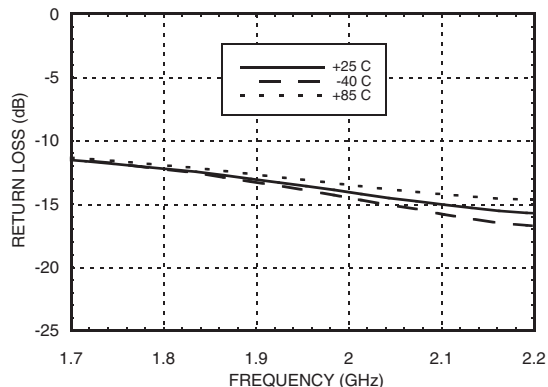

Output Return Loss vs. Temperature

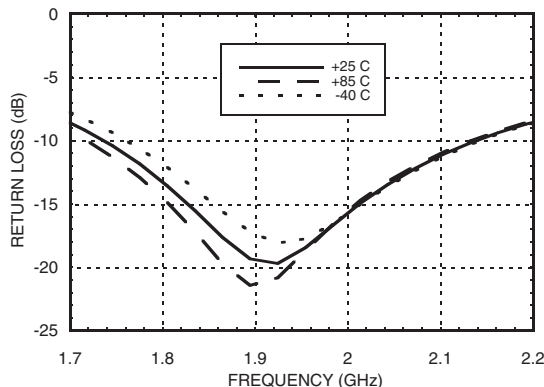

Output IP3 vs. Temperature

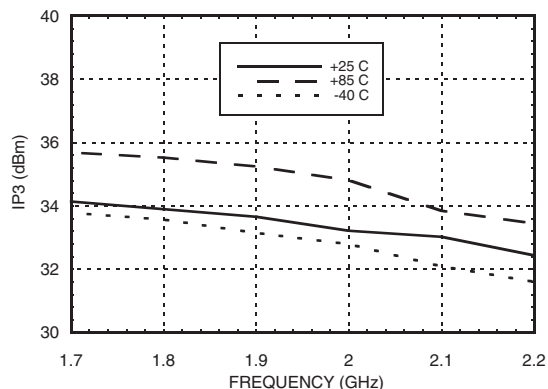

P1dB & PSAT vs. Temperature

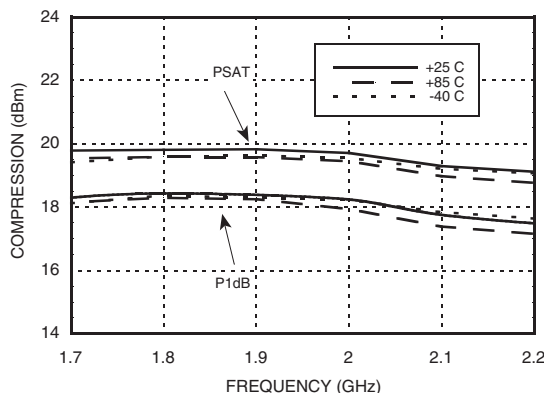

Output IP3 vs. Vdd

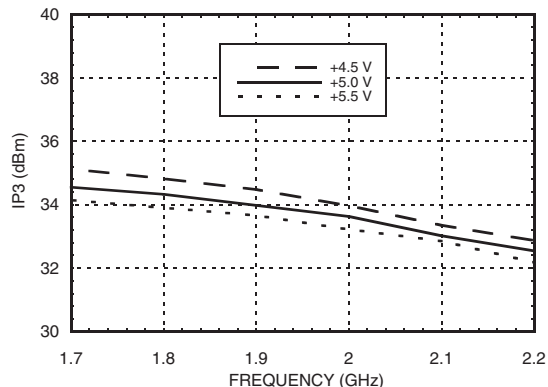

P1dB vs. Vdd

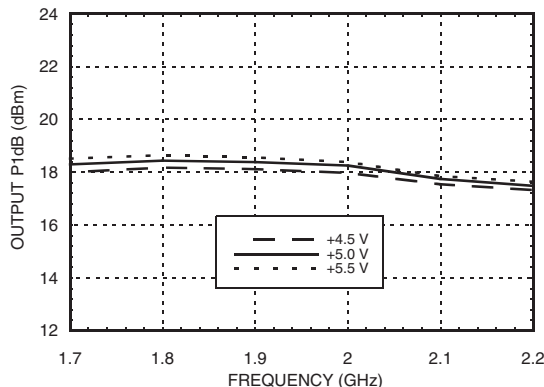

Information furnished by Analog Devices is believed to be accurate and reliable. However, no responsibility is assumed by Analog Devices for its use, nor for any infringements of patents or other rights of third parties that may result from its use. Specifications subject to change without notice. No license is granted by implication or otherwise under any patent or patent rights of Analog Devices. Trademarks and registered trademarks are the property of their respective owners.

For price, delivery, and to place orders: Analog Devices, Inc., One Technology Way, P.O. Box 9106, Norwood, MA 02062-9106 Phone: 781-329-4700 • Order online at www.analog.com Application Support: Phone: 1-800-ANALOG-D

GaAs PHEMT MMIC LOW NOISE AMPLIFIER, 1.7 - 2.2 GHz



Absolute Maximum Ratings

Drain Bias Voltage (Vdd1, Vdd2)	+8.0 Vdc
RF Input Power (RFIN)(Vs = +5.0 Vdc)	+10 dBm
Channel Temperature	150 °C
Continuous P _{diss} (T = 85 °C) (derate 15.6 mW/°C above 85 °C)	1.015 W
Thermal Resistance (channel to ground paddle)	64.1 °C/W
Storage Temperature	-65 to +150 °C
Operating Temperature	-40 to +85 °C

Typical Supply Current vs. Vdd

Vdd (Vdc)	I _{dd} (mA)
+4.5	135
+5.0	136
+5.5	137



ELECTROSTATIC SENSITIVE DEVICE
OBSERVE HANDLING PRECAUTIONS

Outline Drawing

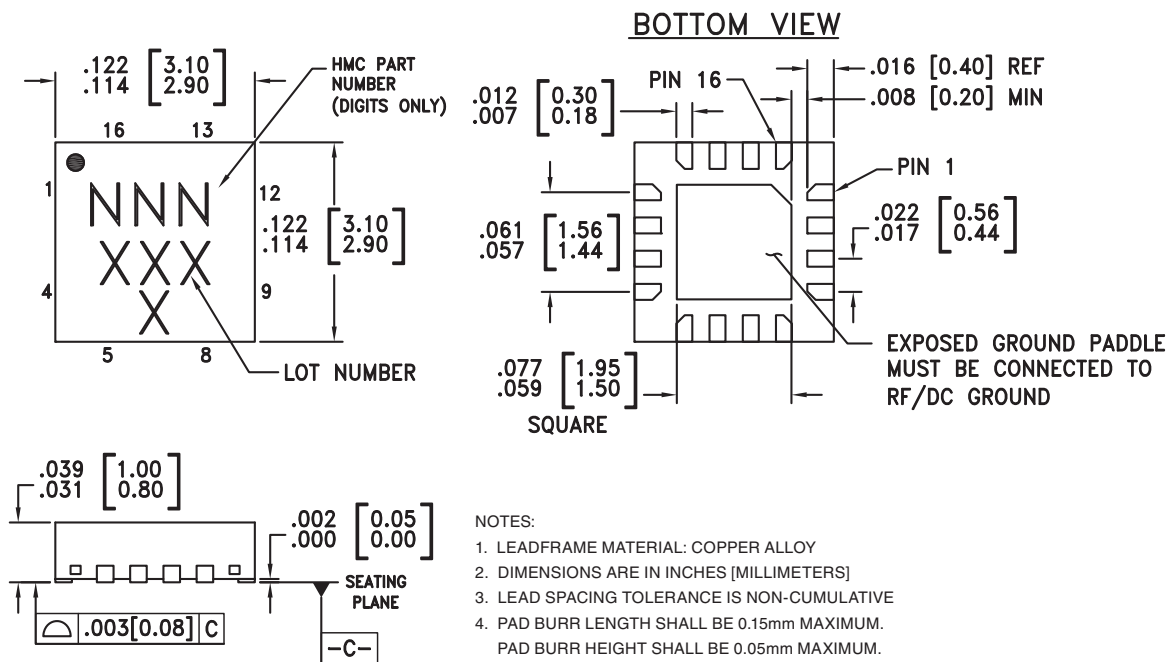

Package Information

Part Number	Package Body Material	Lead Finish	MSL Rating	Package Marking ^[3]
HMC375LP3	Low Stress Injection Molded Plastic	Sn/Pb Solder	MSL1 ^[1]	375 XXXX
HMC375LP3E	RoHS-compliant Low Stress Injection Molded Plastic	100% matte Sn	MSL1 ^[2]	375 XXXX

[1] Max peak reflow temperature of 235 °C

[2] Max peak reflow temperature of 260 °C

[3] 4-Digit lot number XXXX



Pin Descriptions

Pin Number	Function	Description	Interface Schematic
1, 3, 4, 6-10, 12, 14, 16	N/C	No connection necessary. These pins may be connected to RF/DC ground.	
2	RFIN	This pin is matched to 50 Ohms with a 13 nH inductor to ground. See Application Circuit.	RFIN ○ —
5	ACG	AC Ground - An external capacitor of 0.01μF to ground is required for low frequency bypassing. See Application Circuit for further details.	
11	RFOUT	This pin is AC coupled and matched to 50 Ohms.	— ○ RFOUT
13,15	Vdd2, Vdd1	Power supply voltage. Choke inductor and bypass capacitor are required. See application circuit.	
	GND	Package bottom must be connected to RF/DC ground.	○ GND

Application Circuit

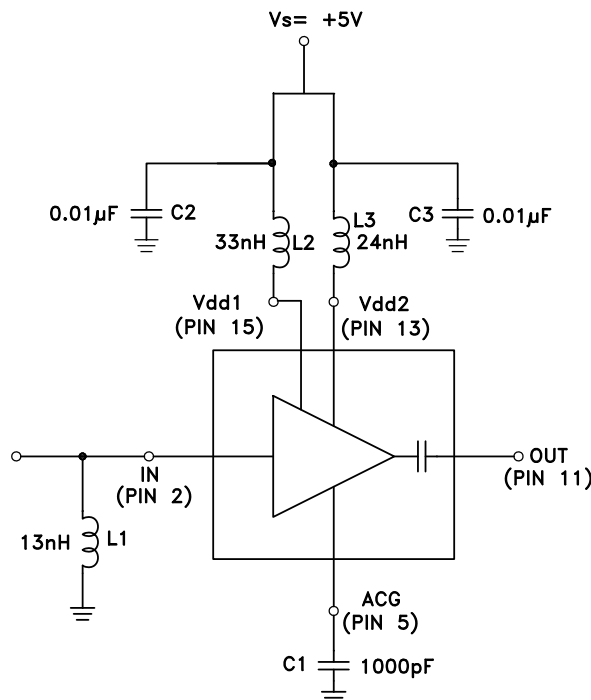

Note: L1, L2, L3 and C1 should be located as close to pins as possible.

Information furnished by Analog Devices is believed to be accurate and reliable. However, no responsibility is assumed by Analog Devices for its use, nor for any infringements of patents or other rights of third parties that may result from its use. Specifications subject to change without notice. No license is granted by implication or otherwise under any patent or patent rights of Analog Devices. Trademarks and registered trademarks are the property of their respective owners.

For price, delivery, and to place orders: Analog Devices, Inc., One Technology Way, P.O. Box 9106, Norwood, MA 02062-9106 Phone: 781-329-4700 • Order online at www.analog.com Application Support: Phone: 1-800-ANALOG-D



Evaluation PCB

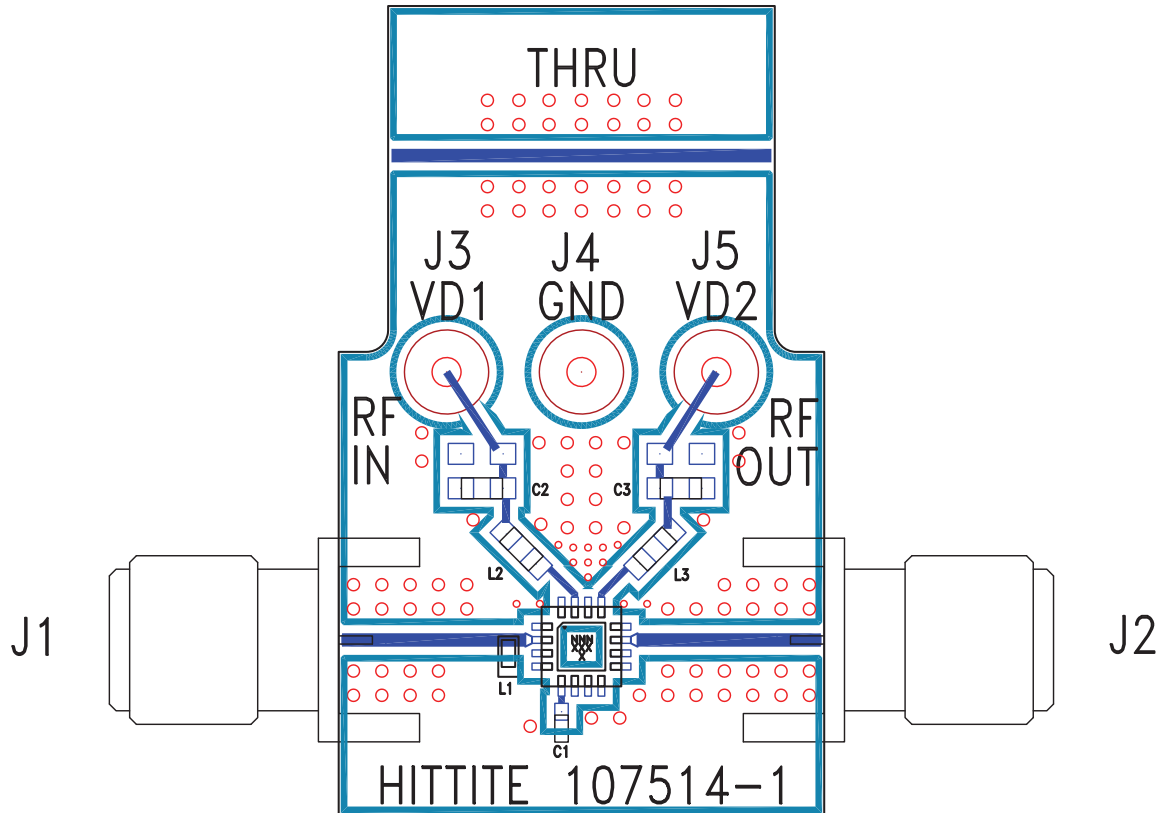

List of Materials for Evaluation PCB 107726 [1]

Item	Description
J1 - J2	PCB Mount SMA RF Connector
J3 - J4	DC Pin
C1	1000 pF Capacitor, 0402 Pkg.
C2, C3	10000 pF Capacitor, 0603 Pkg.
L1	13nH Inductor, 0402 Pkg.
L2	33nH Inductor, 0603 Pkg.
L3	24nH Inductor, 0402 Pkg.
U1	HMC375LP3 / HMC375LP3E Amplifier
PCB [2]	107514 Evaluation PCB

[1] Reference this number when ordering complete evaluation PCB

[2] Circuit Board Material: Rogers 4350

The circuit board used in the application should use RF circuit design techniques. Signal lines should have 50 Ohm impedance while the package ground leads and exposed paddle should be connected directly to the ground plane similar to that shown. A sufficient number of via holes should be used to connect the top and bottom ground planes. The evaluation circuit board shown is available from Hittite upon request.

Looking for pricing, stock, or lifecycle information?

Click below to explore more details on WIN SOURCE:

- ⊖ [View HMC375LP3E on WIN SOURCE](#)
- ⊖ [Analog Devices Inc. Information](#)

Optimize Your Supply Chain with WIN SOURCE Solutions

- ✓ Global Sourcing Solution
- ✓ Obsolete Management
- ✓ Cost Control Management
- ✓ Shortage Management
- ✓ Alternative Solution
- ✓ Excess Inventory Management