



# THE DATASHEET OF HMC373LP3ETR



## GaAs PHEMT MMIC LOW NOISE AMPLIFIER w/ BYPASS MODE, 700 - 1000 MHz



### Typical Applications

The HMC373LP3 / HMC373LP3E is ideal for basestation receivers:

- GSM, GPRS & EDGE
- CDMA & W-CDMA
- Private Land Mobile Radio

### Features

- Noise Figure: 0.9 dB
- Output IP3: +35 dBm
- Gain: 14 dB
- Low Loss LNA Bypass Path
- Single Supply: +5V @ 90 mA
- 50 Ohm Matched Output

### Functional Diagram

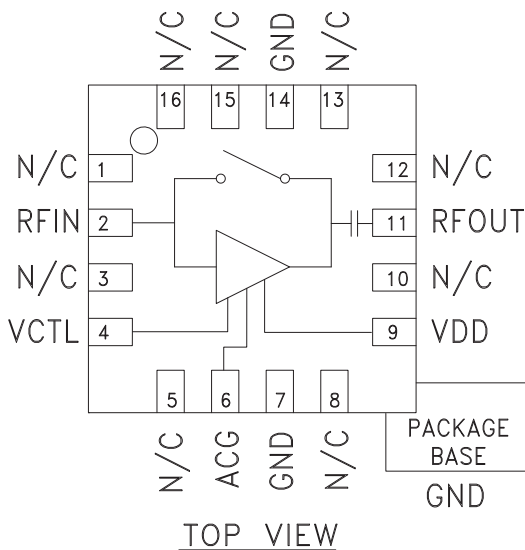

### General Description

The HMC373LP3 / HMC373LP3E are versatile, high dynamic range GaAs MMIC Low Noise Amplifiers that integrates a low loss LNA bypass mode on the IC. The amplifier is ideal for GSM & CDMA cellular basestation front-end receivers operating between 700 and 1000 MHz and provides 0.9 dB noise figure, 14 dB of gain and +35 dBm IP3 from a single supply of +5V @ 90 mA. Input and output return losses are 28 and 12 dB respectively with the LNA requiring minimal external components to optimize the RF input match, RF ground and DC bias. By presenting an open or short circuit to a single control line, the LNA can be switched into a low 2.0 dB loss bypass mode reducing the current consumption to 10  $\mu$ A. For applications which require improved noise figure, please see the HMC668LP3(E).

### Electrical Specifications, $T_A = +25^\circ C$ , $V_{dd} = +5V$

| Parameter  | LNA Mode  |       |       | LNA Mode   |       |       | Bypass Mode |       |       | Units           |
|--|-----------|-------|-------|------------|-------|-------|-------------|-------|-------|-----------------|
|  | Min.      | Typ.  | Max.  | Min.       | Typ.  | Max.  | Min.        | Typ.  | Max.  |                 |
| Frequency Range  | 810 - 960 |       |       | 700 - 1000 |       |       | 700 - 1000  |       |       | MHz             |
| Gain   | 11.5      | 13.5  |       | 10.5       | 14    |       | -2.8        | -2.0  |       | dB              |
| Gain Variation Over Temperature  |           | 0.008 | 0.015 |            | 0.008 | 0.015 |             | 0.002 | 0.004 | dB / $^\circ C$ |
| Noise Figure   |           | 0.9   | 1.3   |            | 1.0   | 1.4   |             |       |       | dB              |
| Input Return Loss  |           | 28    |       |            | 25    |       |             | 30    |       | dB              |
| Output Return Loss   |           | 12    |       |            | 11    |       |             | 25    |       | dB              |
| Reverse Isolation  |           | 20    |       |            | 19    |       |             |       |       | dB              |
| Power for 1dB Compression (P1dB)*  | 18        | 21    |       | 17         | 20    |       |             | 30    |       | dBm             |
| Saturated Output Power (P <sub>sat</sub> )   |           | 22.5  |       |            | 22    |       |             |       |       | dBm             |
| Third Order Intercept (IP3)*<br>(-20 dBm Input Power per tone, 1 MHz tone spacing) |           | 35.5  |       |            | 35    |       |             | 50    |       | dBm             |
| Supply Current (I <sub>dd</sub> )  |           | 90    |       |            | 90    |       |             | 0.01  |       | mA              |

\* P1dB and IP3 for LNA Mode are referenced to RFOUT while P1dB and IP3 for Bypass Mode are referenced to RFIN.



**GaAs PHEMT MMIC LOW NOISE  
AMPLIFIER w/ BYPASS MODE, 700 - 1000 MHz**

**LNA Broadband Gain & Return Loss**

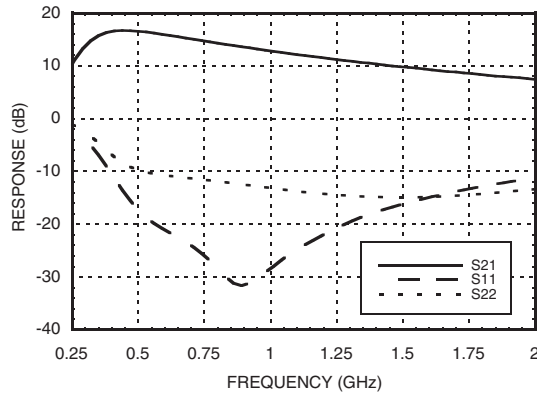

**LNA – Gain, Noise Figure & Power vs. Supply Voltage @ 850 MHz**

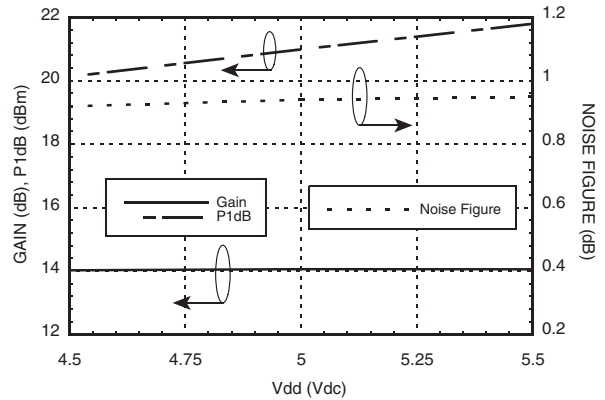

**LNA Gain vs. Temperature**

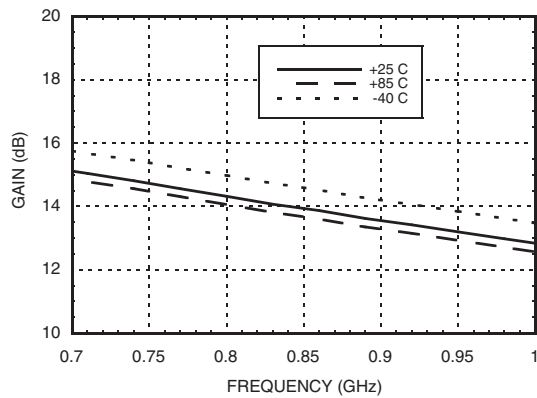

**LNA Noise Figure vs. Temperature**

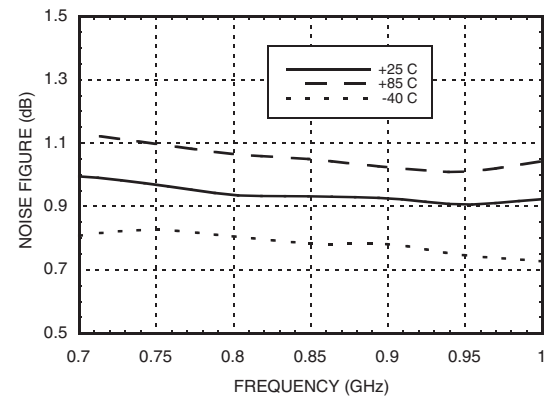

**LNA Gain vs. Vdd**

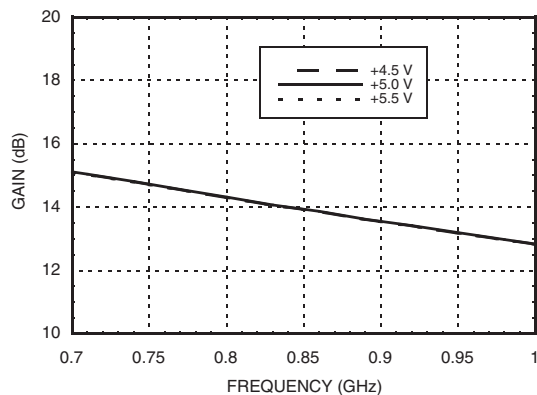

**LNA Noise Figure vs. Vdd**

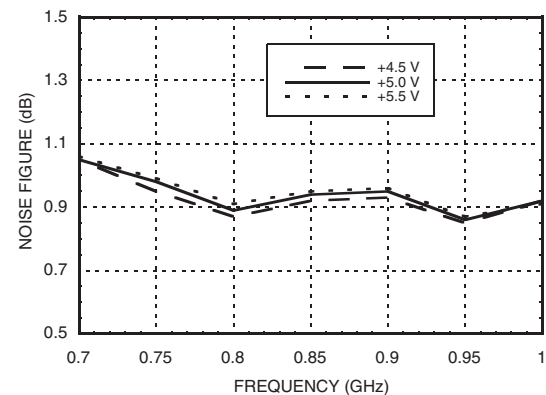

Information furnished by Analog Devices is believed to be accurate and reliable. However, no responsibility is assumed by Analog Devices for its use, nor for any infringements of patents or other rights of third parties that may result from its use. Specifications subject to change without notice. No license is granted by implication or otherwise under any patent or patent rights of Analog Devices. Trademarks and registered trademarks are the property of their respective owners.

For price, delivery, and to place orders: Analog Devices, Inc., One Technology Way, P.O. Box 9106, Norwood, MA 02062-9106 Phone: 781-329-4700 • Order online at [www.analog.com](http://www.analog.com) Application Support: Phone: 1-800-ANALOG-D



**GaAs PHEMT MMIC LOW NOISE AMPLIFIER w/ BYPASS MODE, 700 - 1000 MHz**

**LNA Input Return Loss vs. Temperature**

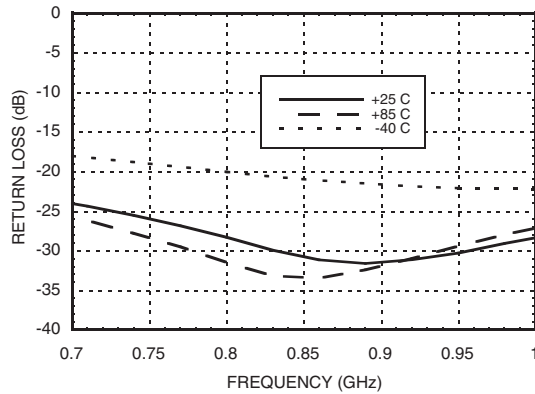

**LNA Output Return Loss vs. Temperature**

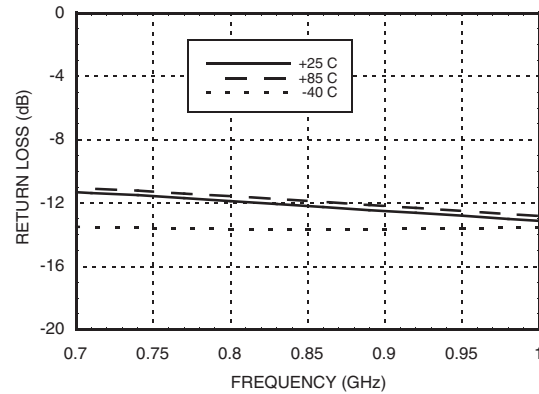

**LNA Output IP3 vs. Temperature**

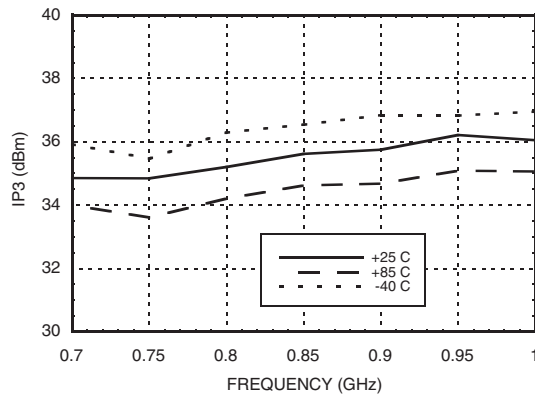

**LNA P1dB & Psat vs. Temperature**

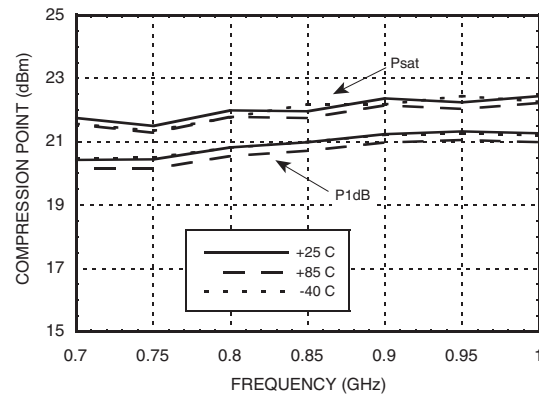

**LNA Output IP3 vs. Vdd**

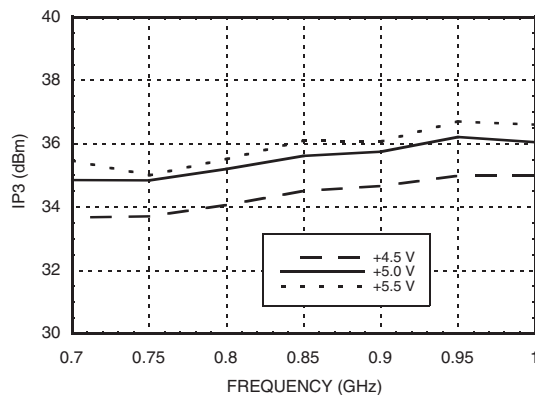

**LNA P1dB vs. Vdd**

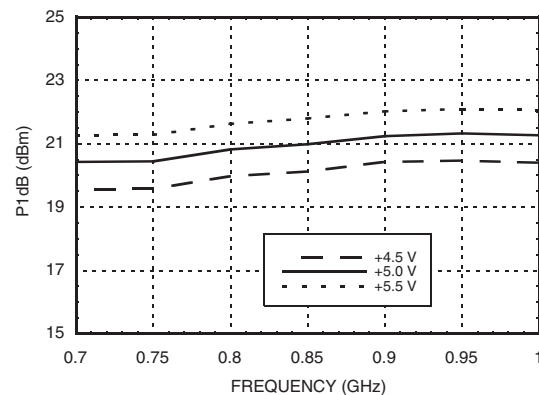

Information furnished by Analog Devices is believed to be accurate and reliable. However, no responsibility is assumed by Analog Devices for its use, nor for any infringements of patents or other rights of third parties that may result from its use. Specifications subject to change without notice. No license is granted by implication or otherwise under any patent or patent rights of Analog Devices. Trademarks and registered trademarks are the property of their respective owners.

For price, delivery, and to place orders: Analog Devices, Inc., One Technology Way, P.O. Box 9106, Norwood, MA 02062-9106 Phone: 781-329-4700 • Order online at [www.analog.com](http://www.analog.com) Application Support: Phone: 1-800-ANALOG-D



**GaAs PHEMT MMIC LOW NOISE AMPLIFIER w/ BYPASS MODE, 700 - 1000 MHz**

**LNA Reverse Isolation vs. Temperature**

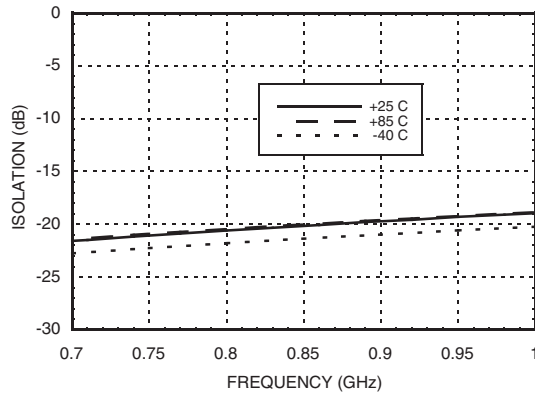

**Bypass Mode Broadband Insertion Loss & Return Loss**

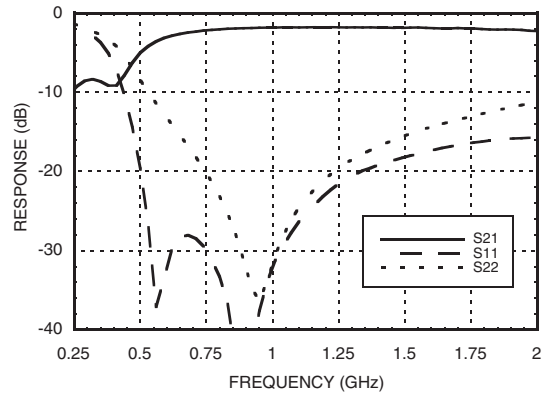

**Bypass Mode Insertion Loss vs. Temperature**

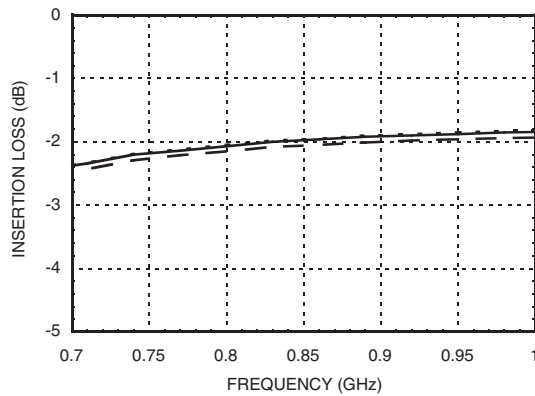

**Bypass Mode Input Return Loss vs. Temperature**

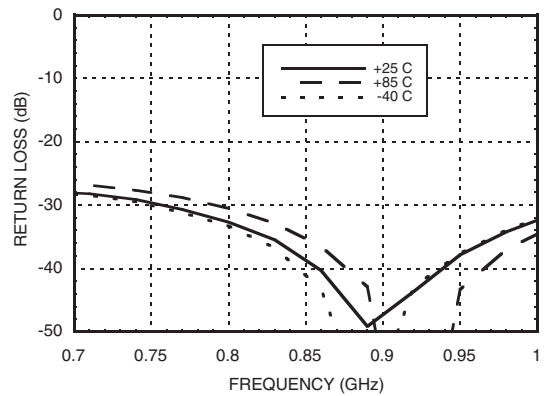

**Bypass Mode Output Return Loss vs. Temperature**

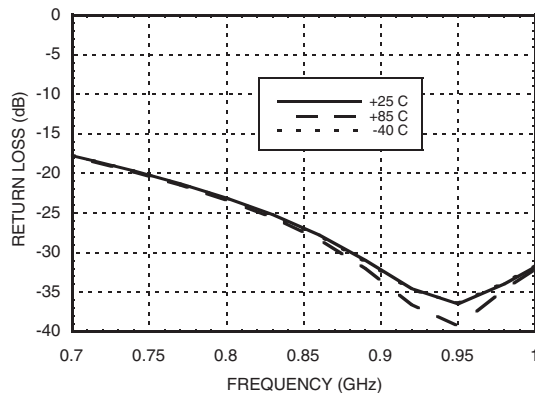

**Bypass Mode Input IP3 vs. Temperature**

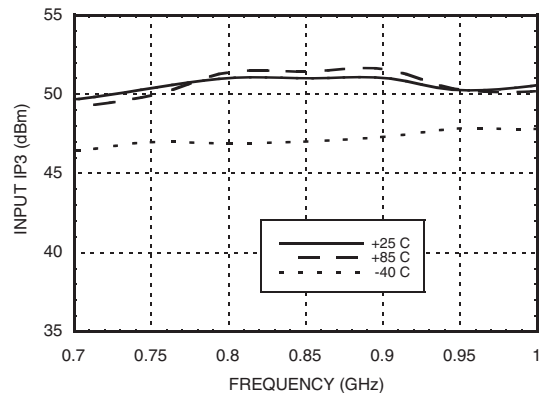

Information furnished by Analog Devices is believed to be accurate and reliable. However, no responsibility is assumed by Analog Devices for its use, nor for any infringements of patents or other rights of third parties that may result from its use. Specifications subject to change without notice. No license is granted by implication or otherwise under any patent or patent rights of Analog Devices. Trademarks and registered trademarks are the property of their respective owners.

For price, delivery, and to place orders: Analog Devices, Inc., One Technology Way, P.O. Box 9106, Norwood, MA 02062-9106 Phone: 781-329-4700 • Order online at [www.analog.com](http://www.analog.com) Application Support: Phone: 1-800-ANALOG-D

## GaAs PHEMT MMIC LOW NOISE AMPLIFIER w/ BYPASS MODE, 700 - 1000 MHz



### Absolute Maximum Ratings

|   |   |
|---|---|
| Drain Bias Voltage (Vdd)  | +8.0 Vdc                                |
| RF Input Power (RFIN)<br>(Vdd = +5.0 Vdc)                                   | LNA Mode +15 dBm<br>Bypass Mode +30 dBm |
| Channel Temperature   | 150 °C                                  |
| Continuous P <sub>diss</sub> (T = 85 °C)<br>(derate 13.5 mW/°C above 85 °C) | 0.878 W                                 |
| Thermal Resistance<br>(channel to ground paddle)                            | 74.1 °C/W                               |
| Storage Temperature   | -65 to +150° C                          |
| Operating Temperature   | -40 to +85° C                           |

### Typical Supply Current vs. Vdd

| Vdd (Vdc) | I <sub>dd</sub> (mA) |
|-----------|----------------------|
| +4.5      | 87                   |
| +5.0      | 90                   |
| +5.5      | 93                   |

### Truth Table

|             |   |
|-------------|---|
| LNA Mode    | V <sub>ctl</sub> = Short Circuit to DC Ground |
| Bypass Mode | V <sub>ctl</sub> = Open Circuit               |



ELECTROSTATIC SENSITIVE DEVICE  
OBSERVE HANDLING PRECAUTIONS

### Outline Drawing

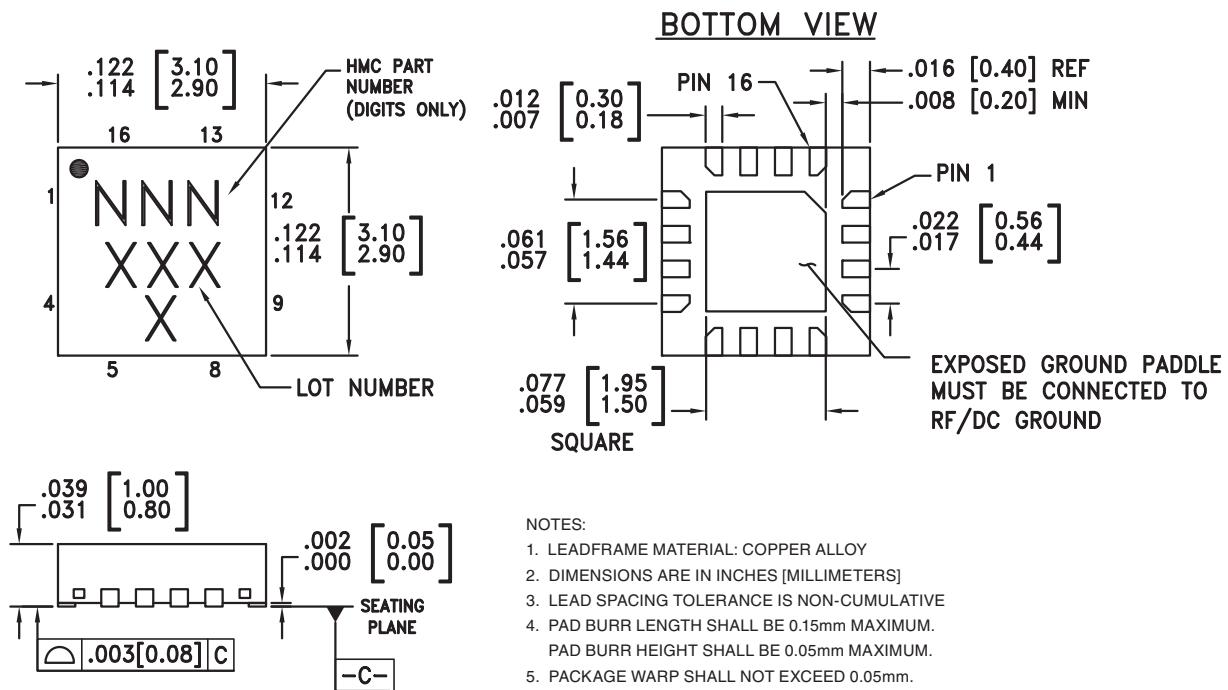

### Package Information

| Part Number | Package Body Material                               | Lead Finish   | MSL Rating          | Package Marking <sup>[3]</sup> |
|-------------|---|---------------|---------------------|--------------------------------|
| HMC373LP3   | Low Stress Injection Molding Plastic                | Sn/Pb Solder  | MSL1 <sup>[1]</sup> | 373<br>XXXX                    |
| HMC373LP3E  | RoHS-compliant Low Stress Injection Molding Plastic | 100% matte Sn | MSL1 <sup>[2]</sup> | 373<br>XXXX                    |



[1] Max peak reflow temperature of 235 °C

[2] Max peak reflow temperature of 260 °C

[3] 4-Digit lot number XXXX

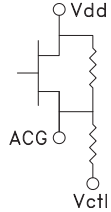
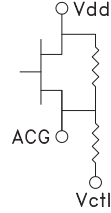

### Pin Descriptions

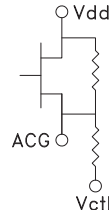
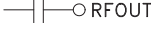
| Pin Number                     | Function | Description   | Interface Schematic   |
|--------------------------------|----------|---|---|
| 1, 3, 5, 8, 10, 12, 13, 15, 16 | N/C      | No connection necessary.<br>These pins may be connected to RF/DC ground.  |   |
| 2                              | RFIN     | This pin is matched to 50 Ohms with a 19 nH inductor to ground. See Application Circuit.  | RFIN ○ —  |
| 4                              | Vctl     | DC ground return. LNA is in high gain mode when a short circuit is introduced to this pin through an external switch. LNA is in bypass mode when open circuit is introduced |    |
| 6                              | ACG      | An external capacitor of 0.01μF to ground is required for low frequency bypassing. See Application Circuit for further details.   |   |
| 7, 14                          | GND      | These pins must be connected to RF/DC ground.   |  |
| 9                              | Vdd      | Power supply voltage. Choke inductor and bypass capacitor are required. See application circuit.  |  |
| 11                             | RFOUT    | This pin is AC coupled and matched to 50 Ohms.  |  |



**GaAs PHEMT MMIC LOW NOISE  
AMPLIFIER w/ BYPASS MODE, 700 - 1000 MHz**

**Evaluation PCB**

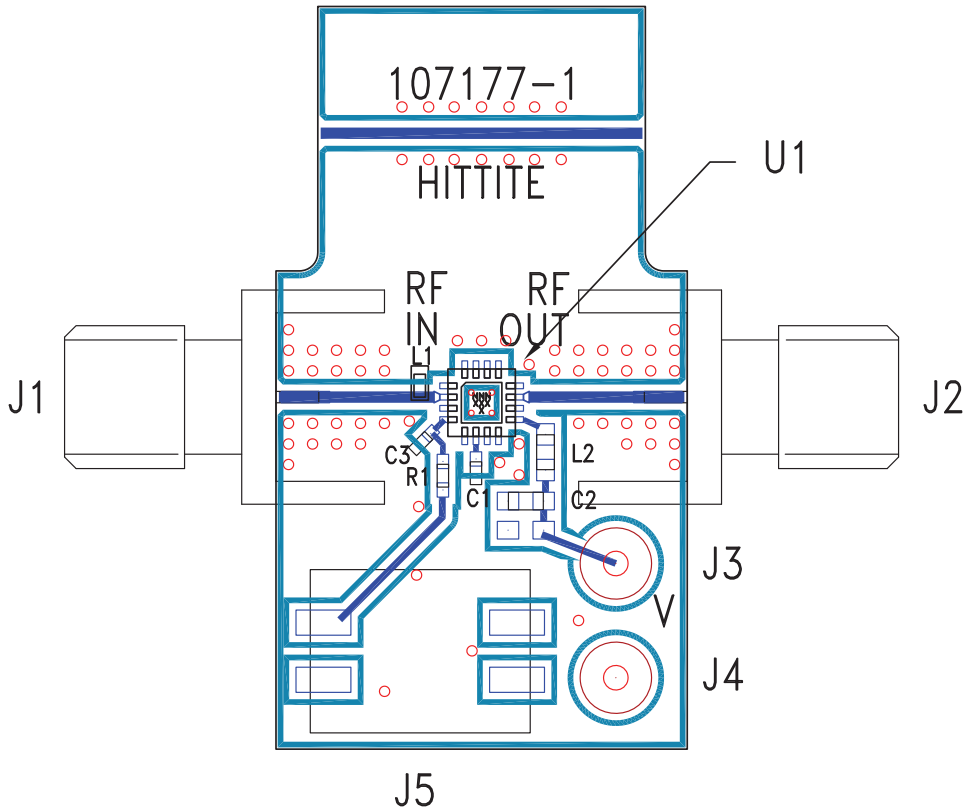

**List of Materials for Evaluation PCB 107220 [1]**

| Item    | Description                      |
|---------|----------------------------------|
| J1 - J2 | PCB Mount SMA RF Connector       |
| J3 - J4 | DC Pin                           |
| J5      | 2 Pos DIP Switch                 |
| C1      | 10000 pF Capacitor, 0402 Pkg.    |
| C2      | 10000 pF Capacitor, 0603 Pkg.    |
| C3      | 1000 pF Capacitor, 0402 Pkg.     |
| L1      | 19 nH Inductor, 0402 Pkg.        |
| L2      | 18 nH Inductor, 0603 Pkg.        |
| R1      | 2 Ohm Resistor, 0402 Pkg.        |
| U1      | HMC373LP3 / HMC373LP3E Amplifier |
| PCB [2] | 107177 Evaluation Board          |

The circuit board used in the application should use RF circuit design techniques. Signal lines should have 50 Ohm impedance while the package ground leads and exposed paddle should be connected directly to the ground plane similar to that shown. A sufficient number of via holes should be used to connect the top and bottom ground planes. The evaluation circuit board shown is available from Hittite upon request.

[1] Reference this number when ordering complete evaluation PCB

[2] Circuit Board Material: Rogers 4350

**GaAs PHEMT MMIC LOW NOISE AMPLIFIER w/ BYPASS MODE, 700 - 1000 MHz**



**Evaluation Board Circuit**

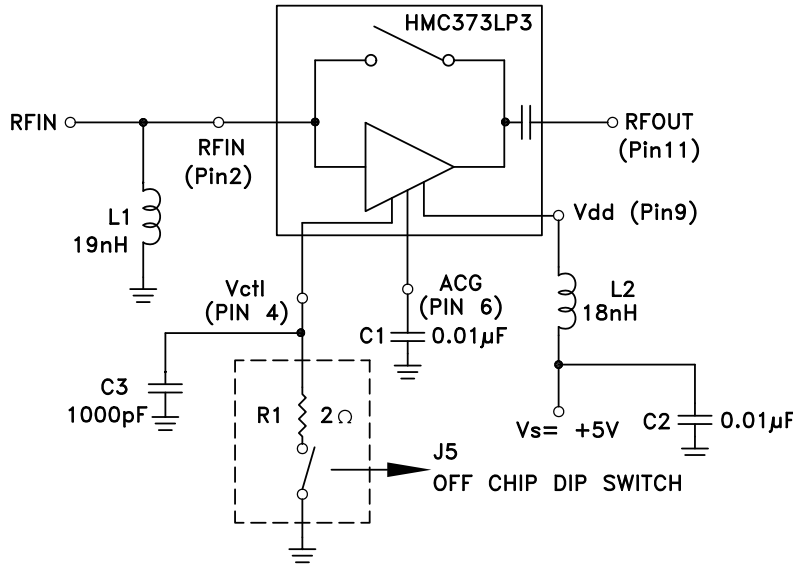

**Application Circuit**

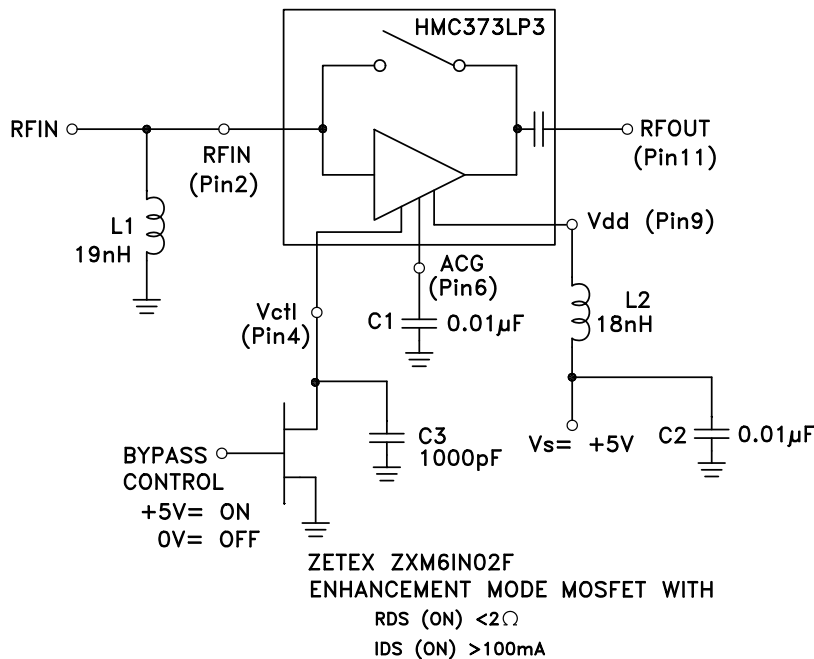

Note 1: Choose value of capacitor C1 for low frequency bypassing. A 0.01 µF ±10% capacitor is recommended.

Note 2: Pin 4 (Vctl) is the DC ground return for the circuit. The LNA is in the high gain mode when a short circuit is introduced to this pin through an external switch. The LNA is in bypass mode when an open circuit is introduced. For the data presented, switching is done through a two position DIP switch (J5) in series with a 2 Ohm resistor (to account for the Ron of an electrical switch).

Note 3: L1, L2 and C1 should be located as close to pins as possible.

Information furnished by Analog Devices is believed to be accurate and reliable. However, no responsibility is assumed by Analog Devices for its use, nor for any infringements of patents or other rights of third parties that may result from its use. Specifications subject to change without notice. No license is granted by implication or otherwise under any patent or patent rights of Analog Devices. Trademarks and registered trademarks are the property of their respective owners.

For price, delivery, and to place orders: Analog Devices, Inc., One Technology Way, P.O. Box 9106, Norwood, MA 02062-9106 Phone: 781-329-4700 • Order online at [www.analog.com](http://www.analog.com) Application Support: Phone: 1-800-ANALOG-D

## Looking for pricing, stock, or lifecycle information?

Click below to explore more details on WIN SOURCE:

-  [View HMC373LP3ETR on WIN SOURCE](#)
-  [Analog Devices Inc. Information](#)

## Optimize Your Supply Chain with WIN SOURCE Solutions

-  Global Sourcing Solution
-  Obsolete Management
-  Cost Control Management
-  Shortage Management
-  Alternative Solution
-  Excess Inventory Management