



## GaAs InGaP HBT MMIC DRIVER AMPLIFIER, 3.0 - 4.5 GHz

### Typical Applications

The HMC326MS8G / HMC326MS8GE is ideal for:

- Microwave Radios
- Broadband Radio Systems
- Wireless Local Loop Driver Amplifier

### Features

- Psat Output Power: +26 dBm
- > 40% PAE
- Output IP3: +36 dBm
- High Gain: 21 dB
- Vs: +5V
- Ultra Small Package: MSOP8G

### Functional Diagram

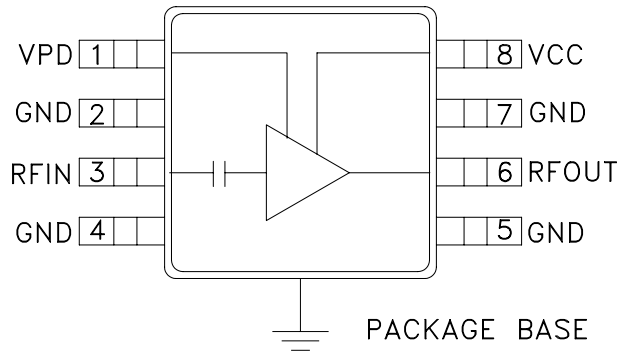

### General Description

The HMC326MS8G & HMC326MS8GE are high efficiency GaAs InGaP Heterojunction Bipolar Transistor (HBT) MMIC driver amplifiers which operate between 3.0 and 4.5 GHz. The amplifier is packaged in a low cost, surface mount 8 leaded package with an exposed base for improved RF and thermal performance. The amplifier provides 21 dB of gain and +26 dBm of saturated power from a +5V supply voltage. Power down capability is available to conserve current consumption when the amplifier is not in use. Internal circuit matching was optimized to provide greater than 40% PAE.

### Electrical Specifications, $T_A = +25^\circ\text{C}$ , $V_s = 5\text{V}$ , $V_{pd} = 5\text{V}$

Parameter	Min.	Typ.	Max.	Units
Frequency Range	3.0 - 4.5			GHz
Gain	18	21		dB
Gain Variation Over Temperature		0.025	0.035	dB / °C
Input Return Loss		12		dB
Output Return Loss		7		dB
Output Power for 1dB Compression (P1dB)	21	23.5		dBm
Saturated Output Power (Psat)		26		dBm
Output Third Order Intercept (IP3)	32	36		dBm
Noise Figure		5		dB
Supply Current (Icc)	Vpd = 0V		1	uA
Supply Current (Icc)	Vpd = 5V		110	mA
Control Current (Ipd)		7		mA
Switching Speed	tOn/tOff		10	ns

## GaAs InGaP HBT MMIC DRIVER AMPLIFIER, 3.0 - 4.5 GHz

**Broadband Gain & Return Loss**

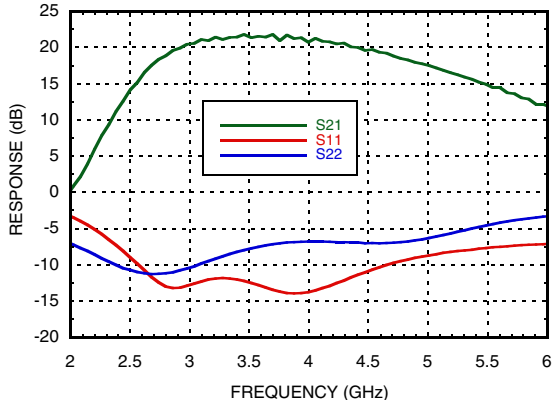

**Gain vs. Temperature**

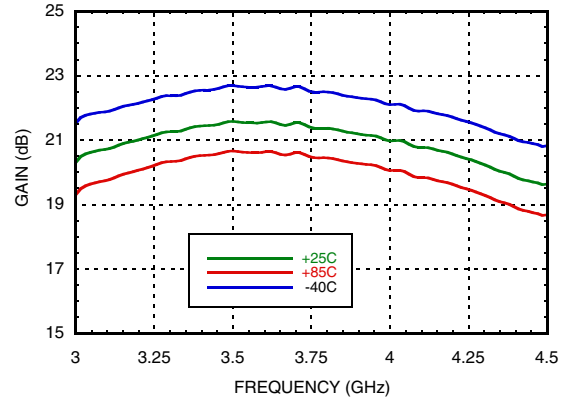

**P1dB vs. Temperature**

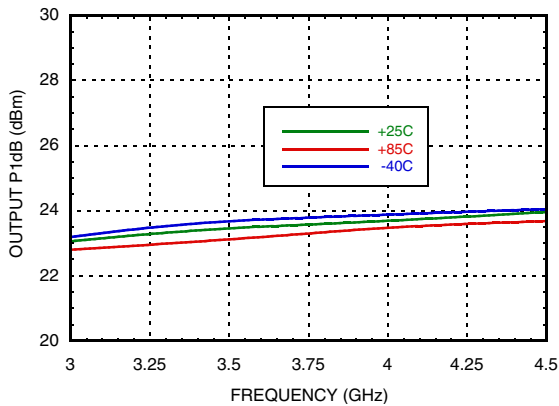

**Psat vs. Temperature**

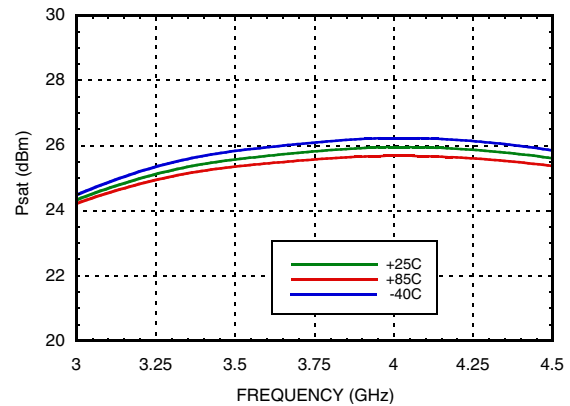

**Output IP3 vs. Temperature**

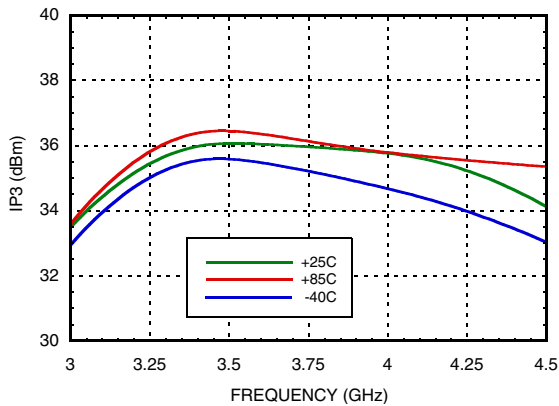

**Power Compression @ 3.5 GHz**

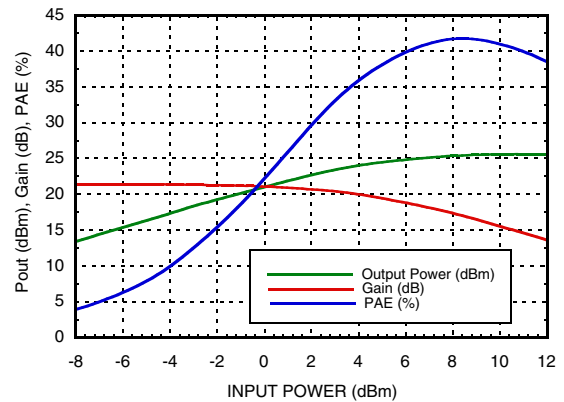

## GaAs InGaP HBT MMIC DRIVER AMPLIFIER, 3.0 - 4.5 GHz

**Input Return Loss vs. Temperature**

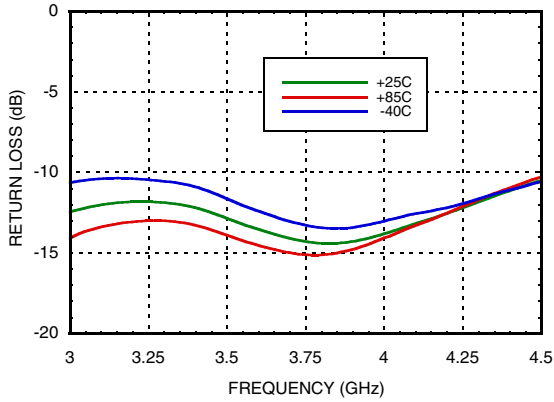

**Output Return Loss vs. Temperature**

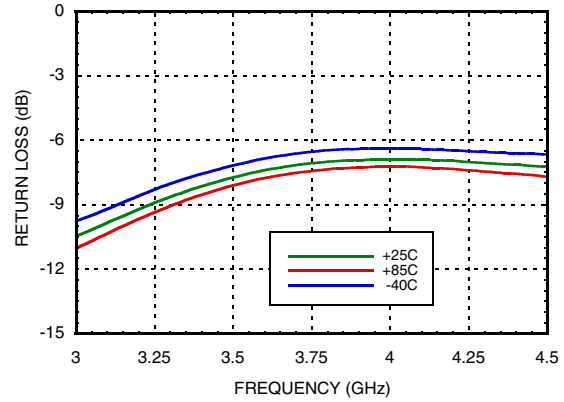

**Reverse Isolation vs. Temperature**

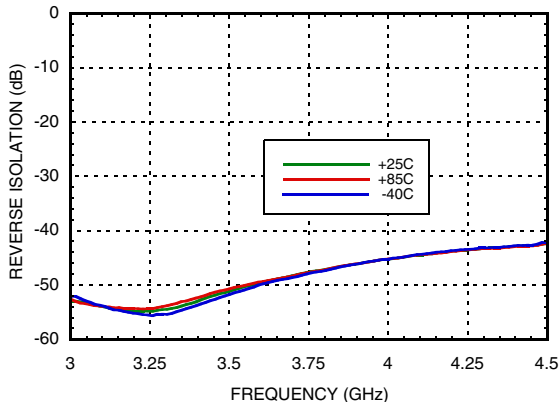

**Noise Figure vs. Temperature**

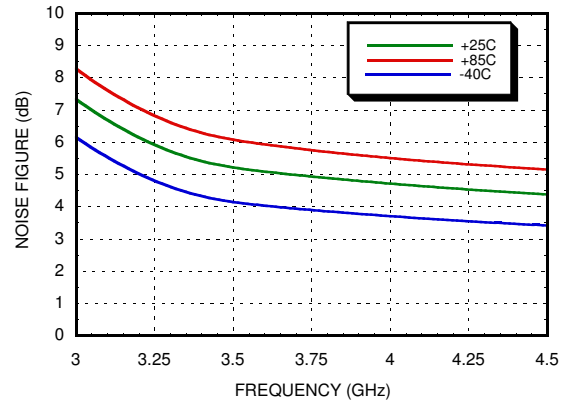

**Gain, Power & Quiescent Supply Current vs. Vpd @3.5 GHz**

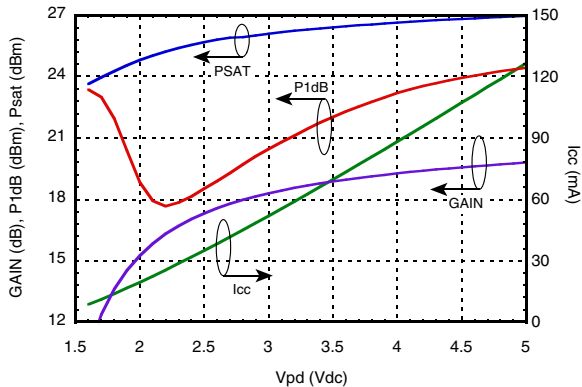

**Additive Phase Noise Vs Offset Frequency, RF Frequency = 4 GHz, RF Input Power = 10 dBm (Psat)**

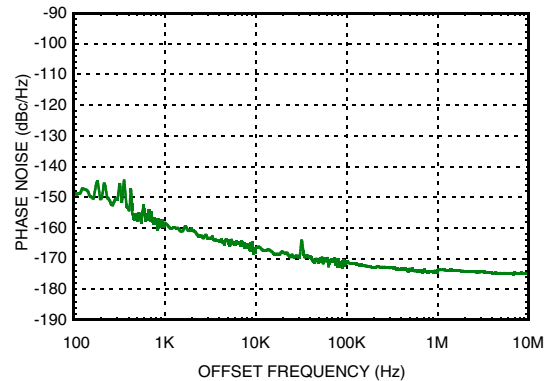

## GaAs InGaP HBT MMIC DRIVER AMPLIFIER, 3.0 - 4.5 GHz

### Absolute Maximum Ratings

Collector Bias Voltage (Vcc)	+5.5 Vdc
Control Voltage Range (Vpd)	+5.5 Vdc
RF Input Power (RFIN)(Vs = Vpd = +5Vdc)	+15 dBm
Junction Temperature	150 °C
Continuous Pdiss (T = 85 °C) (derate 14 mW/°C above 85 °C)	0.916 W
Thermal Resistance (junction to ground paddle)	71 °C/W
Storage Temperature	-65 to +150 °C
Operating Temperature	-40 to +85 °C
ESD Sensitivity (HBM)	Class 1A



ELECTROSTATIC SENSITIVE DEVICE  
OBSERVE HANDLING PRECAUTIONS

### Outline Drawing

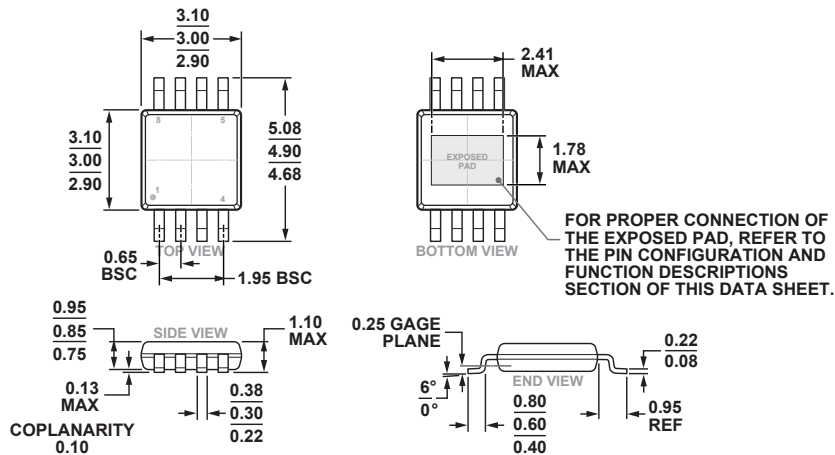

COMPLIANT TO JEDEC STANDARDS MO-187-AA-T

8-Lead Mini Small Outline Package with Exposed Pad [MINI\_SO\_EP]  
(RH-8-4)

Dimensions shown in millimeters.

### Package Information

Part Number	Package Body Material	Lead Finish	MSL Rating	Package Marking <sup>[3]</sup>
HMC326MS8G	Low Stress Injection Molded Plastic	Sn/Pb Solder	MSL1 <sup>[1]</sup>	H326 XXXX
HMC326MS8GE	RoHS-compliant Low Stress Injection Molded Plastic	100% matte Sn	MSL1 <sup>[2]</sup>	<u>H326</u> XXXX

[1] Max peak reflow temperature of 235 °C

[2] Max peak reflow temperature of 260 °C

[3] 4-Digit lot number XXXX

## GaAs InGaP HBT MMIC DRIVER AMPLIFIER, 3.0 - 4.5 GHz

### Evaluation PCB

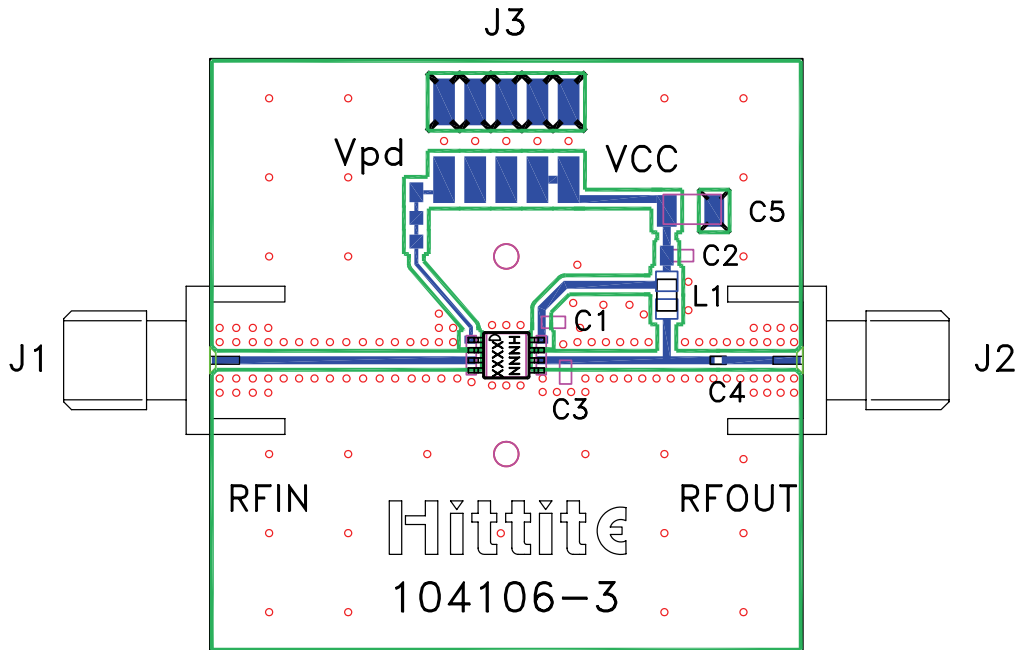

### List of Materials for Evaluation PCB 104356 [1]

Item	Description
J1 - J2	PCB Mount SMA RF Connector
J3	2mm DC Header
C1 - C2	330 pF Capacitor, 0603 Pkg.
C3	0.7 pF Capacitor, 0603 Pkg.
C4	3.0 pF Capacitor, 0402 Pkg.
C5	2.2 $\mu$ F Capacitor, Tantalum
L1	3.3 nH Inductor, 0805 Pkg.
U1	HMC326MS8G / HMC326MS8GE Amplifier
PCB [2]	104106 Eval Board

[1] Reference this number when ordering complete evaluation PCB

[2] Circuit Board Material: Rogers 4350, 10 mil thick,  $\tau_r = 3.48$

The circuit board used in the final application should use RF circuit design techniques. Signal lines should have 50 Ohm impedance while the package ground leads and exposed paddle should be connected directly to the ground plane similar to that shown. A sufficient number of via holes should be used to connect the top and bottom ground planes. The evaluation board should be mounted to an appropriate heat sink. The evaluation circuit board shown is available from Analog Devices upon request.

## GaAs InGaP HBT MMIC DRIVER AMPLIFIER, 3.0 - 4.5 GHz

### Application Circuit

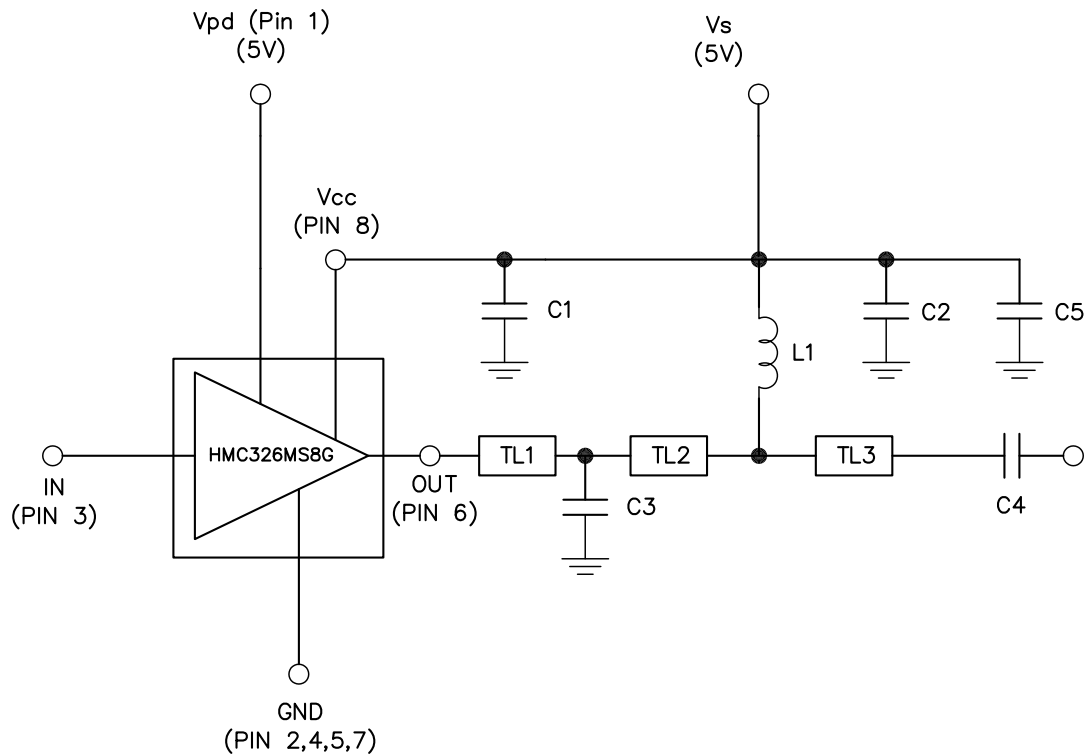

	TL1	TL2	TL3
Impedance	50 ohm	50 ohm	50 ohm
Physical Length	0.0614"	0.2561"	0.110"
Electrical Length @ 3.75 GHz	10.7°	44.6°	19.2°
Measurement	Center of package pin to center of capacitor C3.	Center of capacitor C3 to center TL for inductor.	Center of TL for inductor to edge of capacitor C4.

PCB Material: 10 mil Rogers 4350 or Arlon 25FR

Recommended Component Values	
L1	3.3 nH
C1 - C2	330 pF
C3	0.7 pF
C4	3.0 pF
C5	2.2 μF

## Looking for pricing, stock, or lifecycle information?

Click below to explore more details on WIN SOURCE:

 [View HMC326MS8GE on WIN SOURCE](#)

 [Analog Devices Inc. Information](#)

## Optimize Your Supply Chain with WIN SOURCE Solutions

-  Global Sourcing Solution
-  Obsolete Management
-  Cost Control Management
-  Shortage Management
-  Alternative Solution
-  Excess Inventory Management