



THE DATASHEET OF HMC291



4 dB LSB SILICON 2-BIT POSITIVE CONTROL DIGITAL ATTENUATOR, 0.7 - 4.0 GHz

Typical Applications

The HMC291SE is ideal for:

- Cellular
- PCS, ISM, MMDS
- WLL Handset & Base Station

Features

- RoHS Compliant Product
- 4 dB LSB Steps to 12 dB
- Single Positive Control Per Bit, 0/+3V or +5V
- Typical Step Error : ± 0.3 dB
- Miniature SOT 26 Package: 9 mm²

Functional Diagram

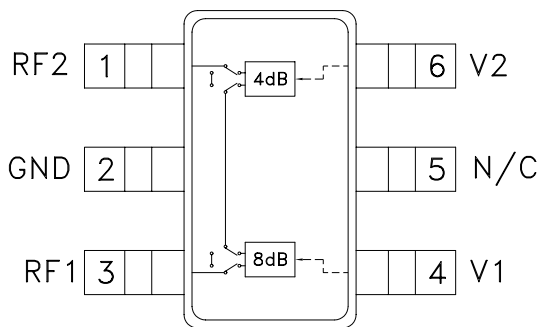

General Description

The HMC291SE is a general purpose broadband 2-bit positive control silicon IC digital attenuator in 6 lead SOT26 surface mount plastic package. The insertion loss is typically in between 0.4 dB - 1 dB through operating frequency range. The attenuator bit values are 4 (LSB) and 8 dB for a total attenuation of 12 dB. State error is excellent at ± 0.4 dB typical with an IIP3 of up to 57 dBm. Two bit control voltage inputs, toggled between 0V and +3V or +5V, are used to select each attenuation state at less than 25 μ A each. A single VDD supply voltage of +3V to +5V applied through an external 4.7K Ohm resistor is required.

Electrical Specifications,

$T_A = +25^\circ\text{C}$, $V_{DD} = +3\text{V to } +5\text{V}$ & $V_{CTL} = 0/V_{DD}$ (Unless Otherwise Stated)

| Parameter | | Frequency | Min. | Typical | Max. | Units |
|---|--|---------------|---|---------|------|-------|
| Insertion Loss | | 0.7 - 1.4 GHz | | 0.5 | 0.65 | dB |
| | | 1.4 - 2.3 GHz | | 0.5 | 0.65 | dB |
| | | 2.3 - 2.7 GHz | | 0.6 | 0.7 | dB |
| | | 2.7 - 4.0 GHz | | 0.8 | 1.32 | dB |
| Attenuation Range | | 0.7 - 4.0 GHz | | 12 | | dB |
| Return Loss (RF1 & RF2, All Atten. States) | | 0.7 - 1.4 GHz | 20 | 25 | | dB |
| | | 1.4 - 4.0 GHz | 17 | 27 | | dB |
| State Error | All Attenuation States | 0.7 - 1.4 GHz | $\pm (0.1 + 4\% \text{ of Atten. Setting Max})$ | | | dB |
| | All Attenuation States | 1.4 - 2.3 GHz | $\pm (0.2 + 2\% \text{ of Atten. Setting Max})$ | | | dB |
| | All Attenuation States | 2.3 - 2.7 GHz | $\pm (0.4 + 3\% \text{ of Atten. Setting Max})$ | | | dB |
| | All Attenuation States | 2.7 - 4.0 GHz | $\pm (0.4 + 4\% \text{ of Atten. Setting Max})$ | | | dB |
| Input Power for 0.1 dB Compression (Input P0.1dB) | 5V ^[1] | 0.7 - 4.0 GHz | | 28 | | dBm |
| | 3V | | | 27 | | dBm |
| Input Third Order Intercept Point (IIP3) (Two-tone Input Power = 15 dBm Each Tone) | 5V | 0.7 - 4.0 GHz | 52 | 57 | 59 | dBm |
| | 3V | | 52 | 54 | 56 | dBm |
| Switching Characteristics | $t_{\text{RISE}}, t_{\text{FALL}}$ (10/90% RF) | 0.7 - 4.0 GHz | | 250 | | ns |
| | $t_{\text{ON}}, t_{\text{OFF}}$ (50% CTL to 10/90% RF) | | | 300 | | ns |

[1] Compression point is above maximum input power

4 dB LSB SILICON 2-BIT POSITIVE CONTROL DIGITAL ATTENUATOR, 0.7 - 4.0 GHz

Insertion Loss

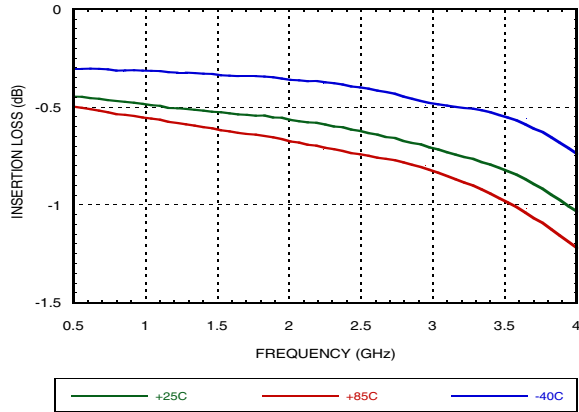

Return Loss RF1, RF2

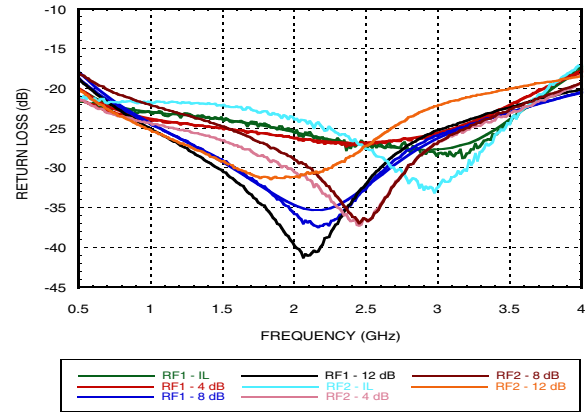

Normalized Attenuation vs. Attenuation State

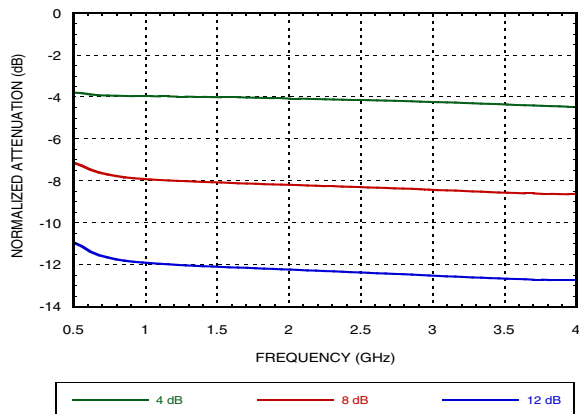

State Error vs. Attenuation State

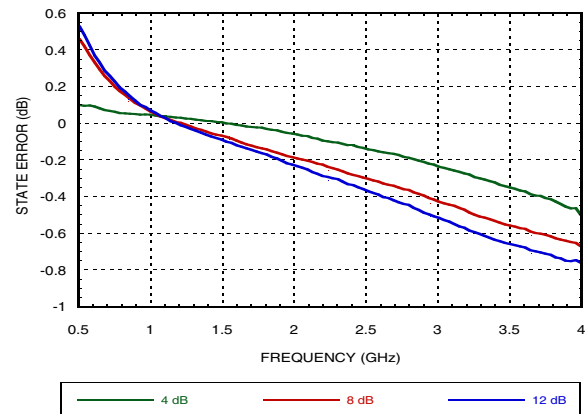

Step Error vs. Frequency

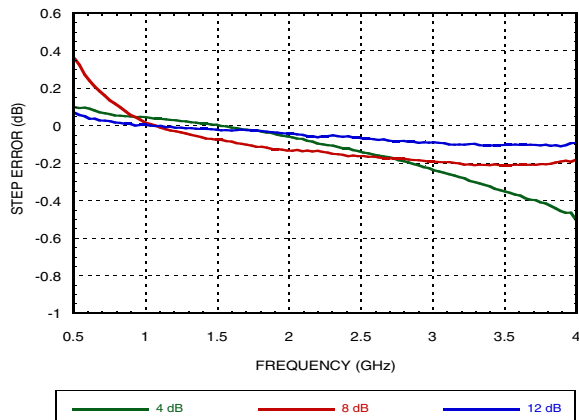

Relative Phase vs. Frequency

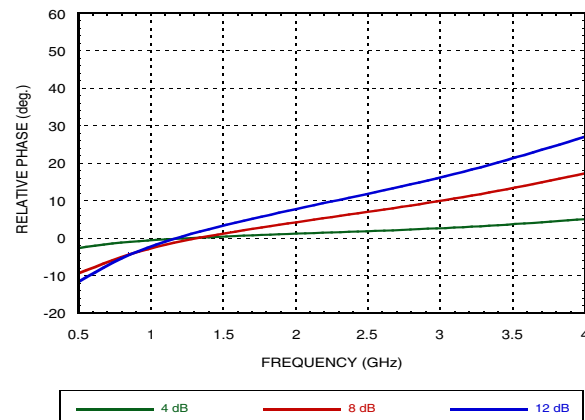

4 dB LSB SILICON 2-BIT POSITIVE CONTROL DIGITAL ATTENUATOR, 0.7 - 4.0 GHz

Input P0.1dB vs. Frequency at 3V over Temperature

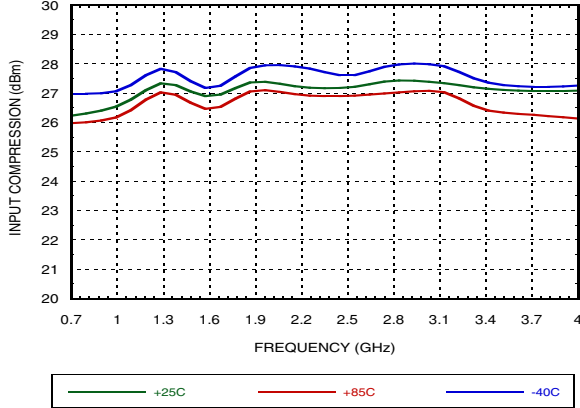

Input P0.1dB vs. Frequency at 5V over Temperature^[1]

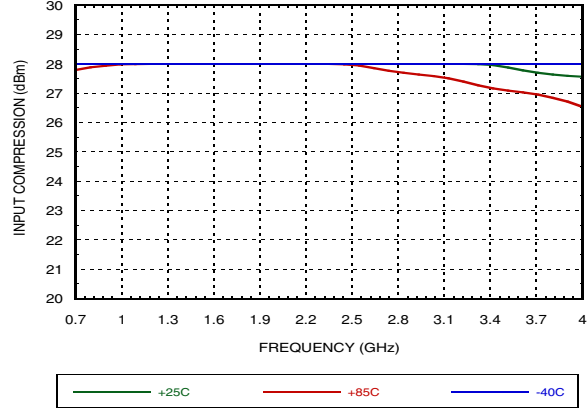

IIP3 vs. Frequency at 3V over Temperature

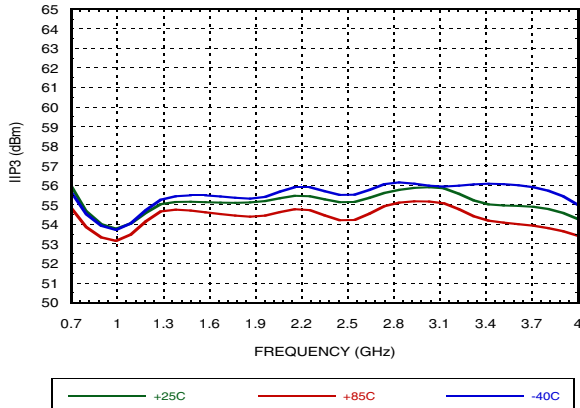

IIP3 vs. Frequency at 5V over Temperature

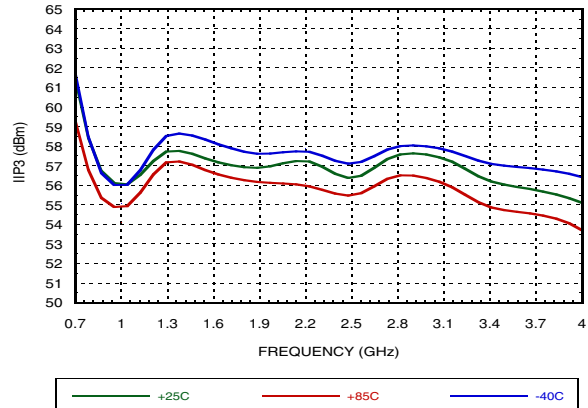

[1] Input P0.1dB is limited by maximum test power of 28 dBm.

4 dB LSB SILICON 2-BIT POSITIVE CONTROL DIGITAL ATTENUATOR, 0.7 - 4.0 GHz

Application Circuit

DC blocking capacitors C1 and C2 are required on RF1 and RF2. Choose C1 = C2 = 100 ~ 300 pF to allow lowest frequency of operation to pass with minimal loss. R1 = 4.7K Ohm is required to supply voltage to the circuit through either PIN 3 or PIN 1.

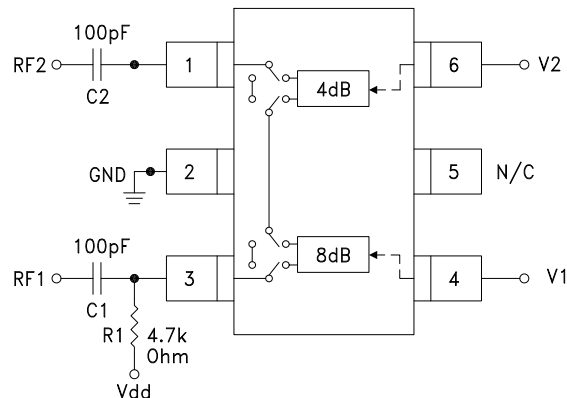

Evaluation Circuit Board

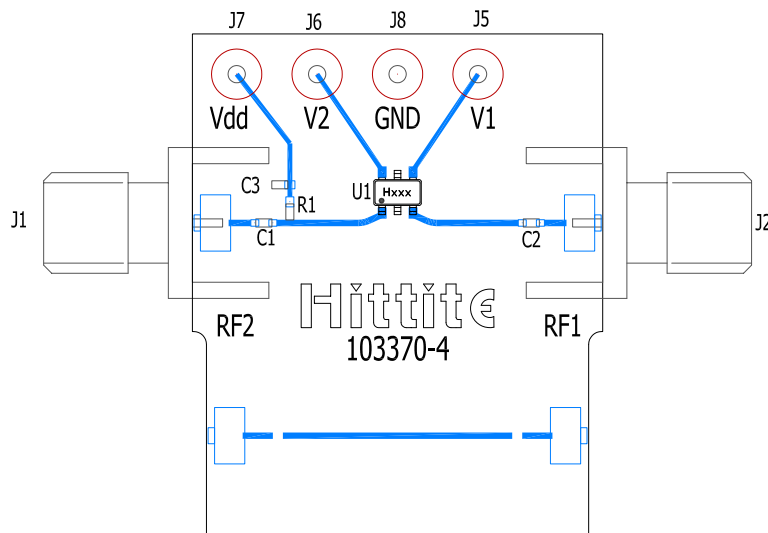

List of Materials for Evaluation PCB EV1HMC291SE [1]

| Item | Description |
|---------|---|
| J1 - J2 | PCB Mount SMA Connector |
| J5 - J8 | DC Pin |
| R1 | 4.7 kOhm Resistor, 0402 Pkg. |
| C1, C2 | 0402 Pkg. Capacitor, Select for Lowest Frequency of Operation |
| C3 | 1 nF capacitor, 0402 Pkg. |
| U1 | HMC291SE Digital Attenuator |
| PCB [2] | 103370 Evaluation PCB 1.5" x 1.5" |

[1] Reference this number when ordering complete evaluation PCB

[2] Circuit Board Material: Rogers 4350

The circuit board used in the application should use RF circuit design techniques. Signal lines should have 50 Ohm impedance while the package ground leads should be connected directly to the ground plane similar to that shown. A sufficient number of via holes should be used to connect the top and bottom ground planes. The evaluation circuit board as shown is available from Analog Devices upon request.

4 dB LSB SILICON 2-BIT POSITIVE CONTROL DIGITAL ATTENUATOR, 0.7 - 4.0 GHz

Truth Table

| Control Voltage Input (VCTL) | | Attenuation Setting RF1 - RF2 |
|------------------------------|------------|----------------------------------|
| V1 8 dB | V2 4 dB | |
| High | High | Reference I.L. |
| High | Low | 4 dB |
| Low | High | 8 dB |
| Low | Low | 12 dB Max. Atten. |

Any combination of the above states will provide an attenuation approximately equal to the sum of the bits selected.



ELECTROSTATIC SENSITIVE DEVICE
OBSERVE HANDLING PRECAUTIONS

Control & Bias Voltages

| State | Bias Condition |
|-------|------------------------------------|
| Low | 0 to +0.2V at 500 μ A Max. |
| High | VDD \pm 0.2V at 550 μ A Max. |

Note: VDD = +3V to 5V with \pm 0.2V tolerance

Absolute Maximum Ratings

| | |
|--------------------------|-----------------|
| Control Voltage (V1, V2) | VDD + 0.5 VDC |
| RF Input Power | +28 dBm |
| Bias Voltage (VDD) | +8.0 Vdc |
| Storage Temperature | -65°C to +150°C |
| Operating Temperature | -40°C to +85°C |
| ESD Sensitivity (HBM) | Class 1C |
| ESD Sensitivity (FICDM) | Class IV |

Outline Drawing

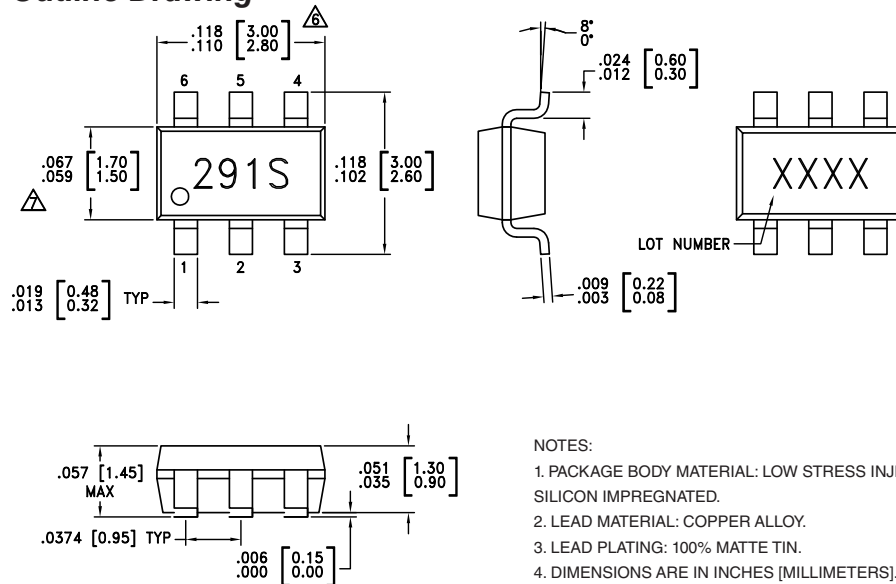

NOTES:

- PACKAGE BODY MATERIAL: LOW STRESS INJECTION MOLDED PLASTIC SILICA AND SILICON IMPREGNATED.
- LEAD MATERIAL: COPPER ALLOY.
- LEAD PLATING: 100% MATTE TIN.
- DIMENSIONS ARE IN INCHES [MILLIMETERS].
- CHARACTERS TO BE HELVETICA MEDIUM, .030 HIGH, LASER OR WHITE INK, LOCATED APPROXIMATELY AS SHOWN.
- Δ DIMENSION DOES NOT INCLUDE MOLDFLASH OF 0.15mm PER SIDE.
- ∇ DIMENSION DOES NOT INCLUDE MOLDFLASH OF 0.25mm PER SIDE.
- ALL GROUND LEADS MUST BE SOLDERED TO PCB RF GROUND.

Package Information

| Part Number | Package Body Material | Lead Finish | MSL Rating | Package Marking ^[1] |
|-------------|--|---------------|---------------------|--------------------------------|
| HMC291SE | RoHS-compliant Low Stress Injection Molded Plastic | 100% matte Sn | MSL1 ^[2] | 291S XXXX |

[1] XXXX 4 digit lot number is on the bottom of package

[2] Max peak reflow temperature of 260°C

Looking for pricing, stock, or lifecycle information?

Click below to explore more details on WIN SOURCE:

 [View HMC291 on WIN SOURCE](#)

 [Analog Devices Inc. Information](#)

Optimize Your Supply Chain with WIN SOURCE Solutions

-  Global Sourcing Solution
-  Obsolete Management
-  Cost Control Management
-  Shortage Management
-  Alternative Solution
-  Excess Inventory Management