



THE DATASHEET OF HMC241LP3ETR





HMC241LP3 / 241LP3E

GaAs MMIC SP4T NON-REFLECTIVE SWITCH, DC - 4 GHz

Typical Applications

The HMC241LP3 / HMC241LP3E is ideal for:

- Base Stations & Repeaters
- WLAN, WiMAX & WiBro
- CATV / DBS
- Test Equipment

Functional Diagram

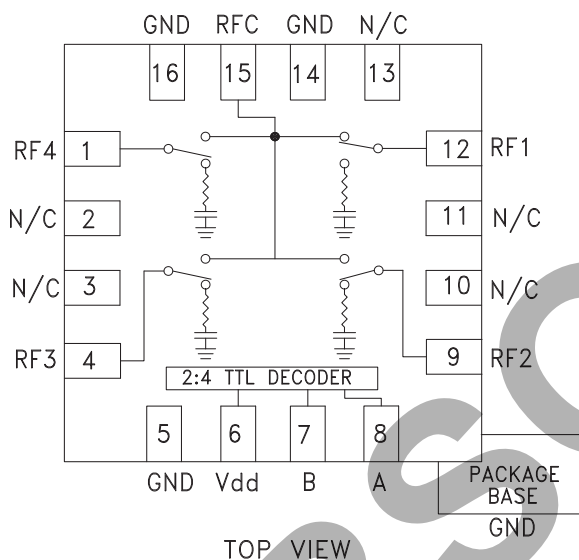

Features

- High Isolation: 43 dB @ 2 GHz
- Low Insertion Loss: 0.7 dB @ 2 GHz
- Single Positive Supply: $V_{dd} = +5V$
- Integrated 2:4 TTL Decoder
- 3x3 mm SMT Package

General Description

The HMC241LP3 & HMC241LP3E are general purpose non-reflective SP4T switches in low cost lead-less surface mount packages. Covering DC - 4 GHz, this switch offers high isolation and has a low insertion loss of 0.7 dB at 2 GHz. The switch offers a single positive bias and true TTL/CMOS compatibility. A 2:4 decoder is integrated on the switch requiring only 2 control lines and a positive bias to select each path, replacing 4 to 8 control lines normally required by GaAs SP4T switches.

Electrical Specifications, $T_A = +25^\circ C$, For TTL Control and $V_{dd} = +5V$ in a 50 Ohm System

Parameter	Frequency	Min.	Typ.	Max.	Units
Insertion Loss	DC - 1.0 GHz		0.6	0.9	dB
	DC - 2.0 GHz		0.7	1.0	dB
	DC - 2.5 GHz		0.9	1.2	dB
	DC - 4.0 GHz		1.2	1.5	dB
Isolation	DC - 1.0 GHz	40	45		dB
	DC - 2.0 GHz	38	43		dB
	DC - 2.5 GHz	35	40		dB
	DC - 4.0 GHz	25	30		dB
Return Loss	"On State"	DC - 2.5 GHz		18	dB
		DC - 4.0 GHz		12	dB
Return Loss	RF1-4 "Off State"	0.3 - 4.0 GHz		12	dB
Input Power for 1dB Compression	0.3 - 4.0 GHz		26		dBm
Input Third Order Intercept (Two-Tone Input Power = +7 dBm Each Tone)	0.3 - 4.0 GHz		45		dBm
Switching Characteristics	0.3 - 4.0 GHz	tRISE, tFALL (10/90% RF)		40	ns
		tON, tOFF (50% CTL to 10/90% RF)		100	ns



Insertion Loss

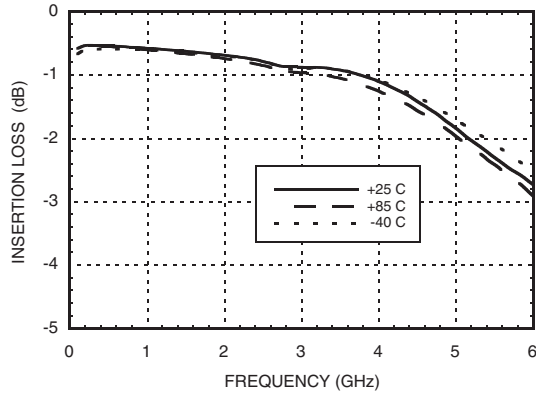

Isolation

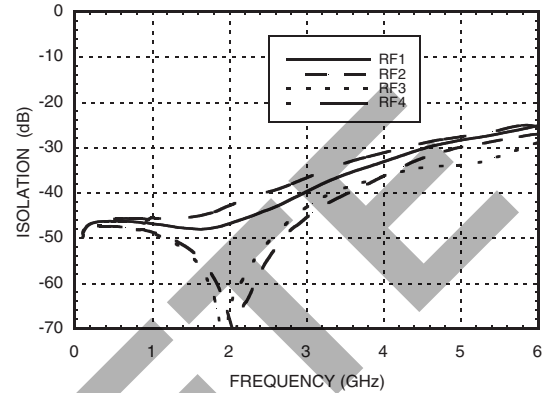

Return Loss

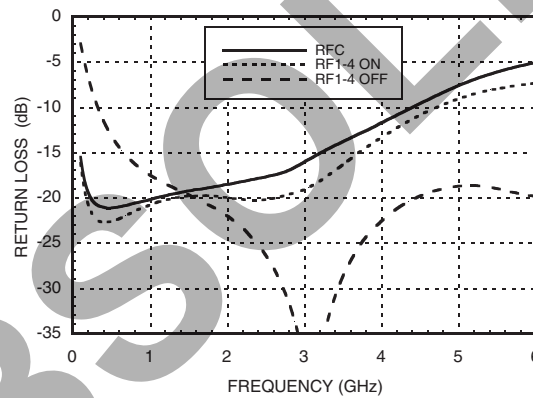

Bias Voltage & Current

Vdd Range = +5.0 Vdc ± 10%		
Vdd (Vdc)	Idd (Typ.) (mA)	Idd (Max.) (mA)
+5.0	2.7	5.0

TTL/CMOS Control Voltages

State	Bias Condition
Low	0 to +0.8 Vdc @ 5uA Typ.
High	+2.0 to +5.0 Vdc @ 70 uA Typ.

NOTE: DC Blocking capacitors are required at ports RFC and RF1, 2, 3, 4.

Truth Table

Control Input		Signal Path State
A	B	RFC to:
LOW	LOW	RF1
HIGH	LOW	RF2
LOW	HIGH	RF3
HIGH	HIGH	RF4



Absolute Maximum Ratings

Bias Voltage Range (Vdd)	+7.0 Vdc
Control Voltage Range (A & B)	-0.5V to Vdd +1 Vdc
Channel Temperature	150 °C
Thermal Resistance (Insertion Loss Path)	200 °C/W
Thermal Resistance (Terminated Path)	240 °C/W
Storage Temperature	-65 to +150 °C
Operating Temperature	-40 to +85 °C
Maximum Input Power Vdd = +5 Vdc	+20 dBm (0.05 - 0.5 GHz) +27 dBm (0.5 - 4.0 GHz)



ELECTROSTATIC SENSITIVE DEVICE
OBSERVE HANDLING PRECAUTIONS

10

SWITCHES - SMT

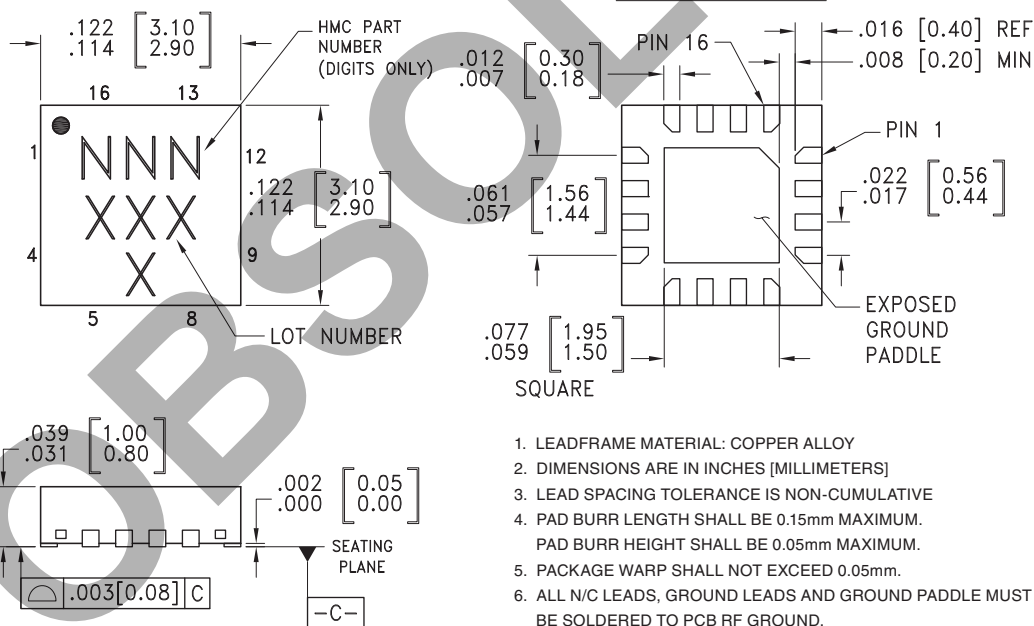

- LEADFRAME MATERIAL: COPPER ALLOY
- DIMENSIONS ARE IN INCHES [MILLIMETERS]
- LEAD SPACING TOLERANCE IS NON-CUMULATIVE
- PAD BURR LENGTH SHALL BE 0.15mm MAXIMUM. PAD BURR HEIGHT SHALL BE 0.05mm MAXIMUM.
- PACKAGE WARP SHALL NOT EXCEED 0.05mm.
- ALL N/C LEADS, GROUND LEADS AND GROUND PADDLE MUST BE SOLDERED TO PCB RF GROUND.
- REFER TO HITTITE APPLICATION NOTE FOR SUGGESTED LAND PATTERN.

Package Information

Part Number	Package Body Material	Leadframe Plating	MSL Rating	Package Marking ^[3]
HMC241LP3	Low Stress Injection Molded Plastic	Sn/Pb Solder	MSL1 ^[1]	241 XXXX
HMC241LP3E	RoHS-compliant Low Stress Injection Molded Plastic	100% Matte Tin	MSL1 ^[2]	241 XXXX

[1] Max peak reflow temperature of 235 °C

[2] Max peak reflow temperature of 260 °C

[3] 4-Digit lot number XXXX

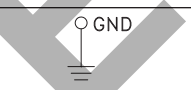
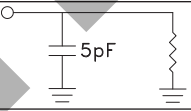
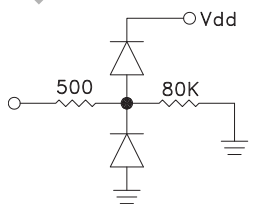

Pin Descriptions

Pin Number	Function	Description	Interface Schematic
1, 4, 9, 12, 15	RF4, RF3, RF2, RF1, RFC	This Pin is DC coupled and matched to 50 Ohm. Blocking capacitors are required.	
2, 3, 10, 11, 13	N/C	This pin should be connected to PCB RF ground to maximize isolation.	
5, 14, 16	GND	Package bottom has exposed metal paddle that must also be connected to PCB RF ground.	
6	Vdd	Supply Voltage +5V ± 10%	
7	B	See truth table and control voltage table.	
8	A	See truth table and control voltage table.	

OBSOLETE



Evaluation PCB

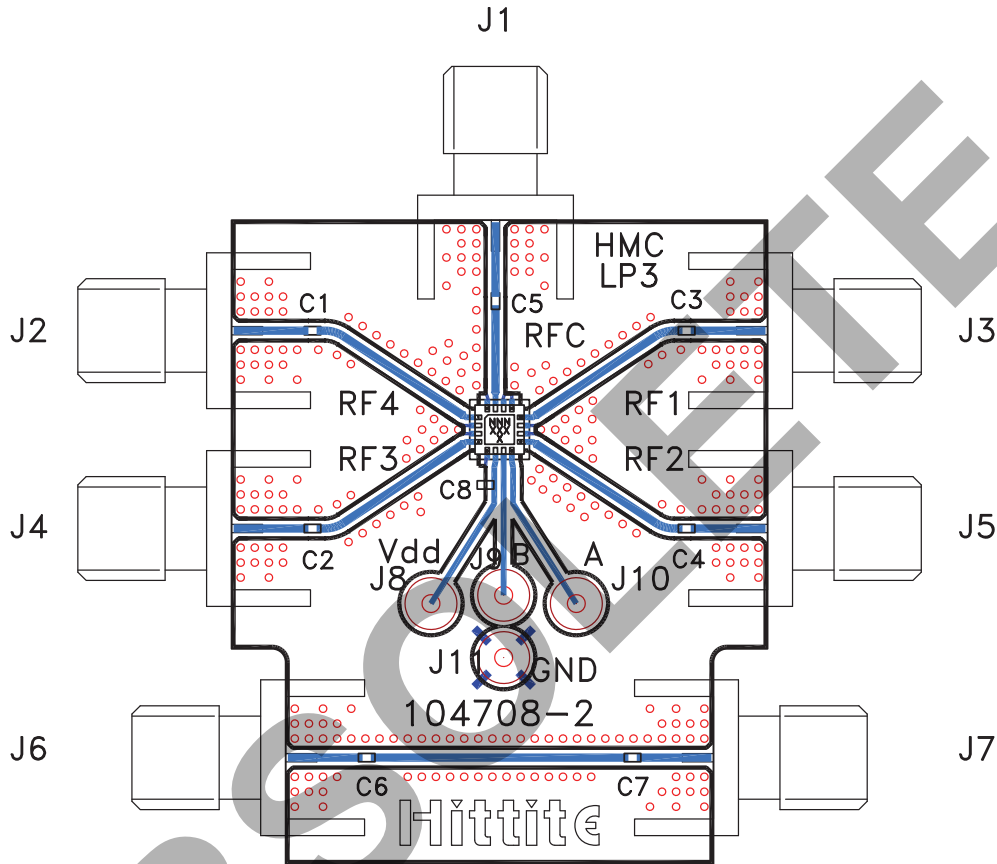

List of Materials for Evaluation PCB 108333 [1]

Item	Description
J1 - J7	PCB Mount SMA RF Connector
J8 - J11	DC Pin
C1 - C7	100 pF Capacitor, 0402 Pkg.
C8	10k pF Capacitor, 0603 Pkg.
U1	HMC241LP3 / HMC241LP3E SP4T Switch
PCB [2]	104708 Evaluation PCB

[1] Reference this number when ordering complete evaluation PCB

[2] Circuit Board Material: Rogers 4350

The circuit board used in the final application should be generated with proper RF circuit design techniques. Signal lines at the RF port should have 50 ohm impedance and the package ground leads and package bottom should be connected directly to the ground plane similar to that shown above. The evaluation circuit board shown above is available from Hittite Microwave Corporation upon request.



Notes:

v01.0905

HMC241LP3 / 241LP3E

GaAs MMIC SP4T NON-REFLECTIVE
SWITCH, DC - 4 GHz

OBSOLETE

10

SWITCHES - SMT

Information furnished by Analog Devices is believed to be accurate and reliable. However, no responsibility is assumed by Analog Devices for its use, nor for any infringements of patents or other rights of third parties that may result from its use. Specifications subject to change without notice. No license is granted by implication or otherwise under any patent or patent rights of Analog Devices. Trademarks and registered trademarks are the property of their respective owners.

For price, delivery, and to place orders: Analog Devices, Inc., One Technology Way, P.O. Box 9106, Norwood, MA 02062-9106
Phone: 781-329-4700 • Order online at www.analog.com
Application Support: Phone: 1-800-ANALOG-D

Looking for pricing, stock, or lifecycle information?

Click below to explore more details on WIN SOURCE:

-  [View HMC241LP3ETR on WIN SOURCE](#)
-  [Analog Devices Inc. Information](#)

Optimize Your Supply Chain with WIN SOURCE Solutions

-  Global Sourcing Solution
-  Obsolete Management
-  Cost Control Management
-  Shortage Management
-  Alternative Solution
-  Excess Inventory Management