



**THE DATASHEET OF
HMC174MS8TR**





Typical Applications

The HMC174MS8(E) is ideal for:

- Infrastructure & Repeaters
- Cellular/3G & WiMAX
- Portable Wireless
- LNA Protection
- Automotive Telematics
- Test Equipment

Features

- Low Insertion Loss: 0.5 dB
- High Input IP3: +60 dBm
- Positive Control: 0/+3V to 0 /+8V
- High RF power Capability
- MSOP - 8 SMT package, 14.8 mm²

Functional Diagram

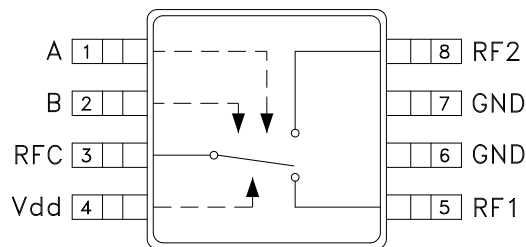

General Description

The HMC174MS8 & HMC174MS8E are low-cost SPDT switches in 8-lead MSOP packages for use in transmit-receive applications which require very low distortion at high signal power levels. The device can control signals from DC to 3 GHz and is especially suited for cellular/3G and WiMAX applications with only 0.5 dB loss. The design provides exceptional intermodulation performance; providing a +60 dBm third order intercept at 8 Volt bias. RF1 and RF2 are reflective shorts when "OFF". On chip circuitry allows single positive supply operation at very low DC current with control inputs compatible with CMOS and most TTL logic families.

Electrical Specifications, $T_A = +25^\circ\text{C}$, $V_{dd} = +5\text{Vdc}$, 50 Ohm System

Parameter		Frequency	Min.	Typ.	Max.	Units
Insertion Loss		DC - 1.0 GHz		0.4	0.7	dB
		DC - 2.0 GHz		0.5	0.8	dB
		DC - 2.5 GHz		0.8	1.1	dB
		DC - 3.0 GHz		1.3	1.8	dB
Isolation		DC - 1.0 GHz	21	26		dB
		DC - 2.0 GHz	21	26		dB
		DC - 2.5 GHz	18	23		dB
		DC - 3.0 GHz	15	20		dB
Return Loss		DC - 1.0 GHz		25		dB
		DC - 2.0 GHz		20		dB
		DC - 2.5 GHz		15		dB
		DC - 3.0 GHz		12		dB
Input Power for 1 dB Compression	0/8V Control	0.5 - 1.0 GHz	32	36		dBm
		0.5 - 3.0 GHz	32	36		dBm
Input Third Order Intercept	0/8V Control	0.5 - 1.0 GHz	55	60		dBm
		0.5 - 3.0 GHz	49	56		dBm
Switching Characteristics		DC - 3.0 GHz				
			tRISE, tFALL (10/90% RF)		10	
		tON, tOFF (50% CTL to 10/90% RF)		24		ns

Information furnished by Analog Devices is believed to be accurate and reliable. However, no responsibility is assumed by Analog Devices for its use, nor for any infringements of patents or other rights of third parties that may result from its use. Specifications subject to change without notice. No license is granted by implication or otherwise under any patent or patent rights of Analog Devices. Trademarks and registered trademarks are the property of their respective owners.

For price, delivery, and to place orders: Analog Devices, Inc., One Technology Way, P.O. Box 9106, Norwood, MA 02062-9106 Phone: 781-329-4700 • Order online at www.analog.com Application Support: Phone: 1-800-ANALOG-D



**GaAs MMIC T/R SWITCH
DC - 3 GHz**

Insertion Loss

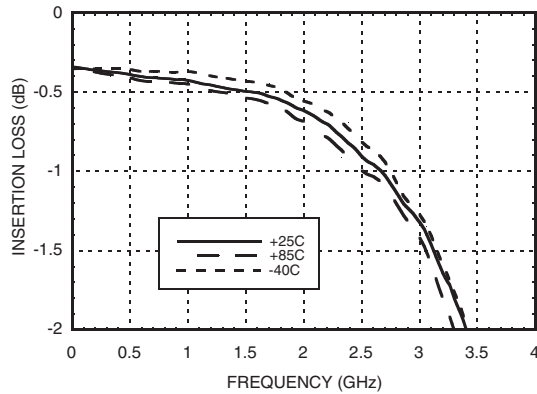

Isolation Between RFC & RF1/RF2

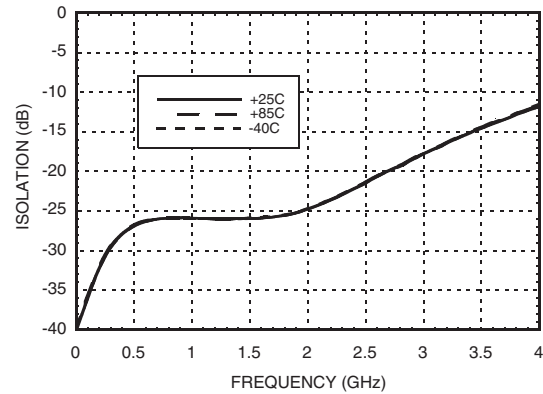

RF1 to RF2 Isolation

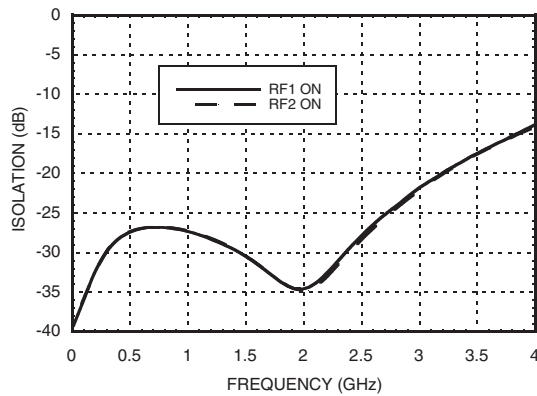

Return Loss

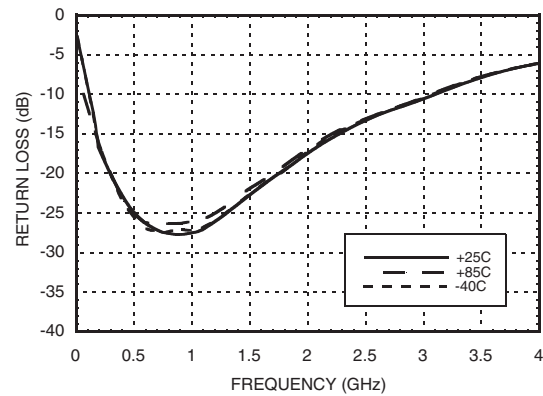

Input P0.1dB vs. Vdd

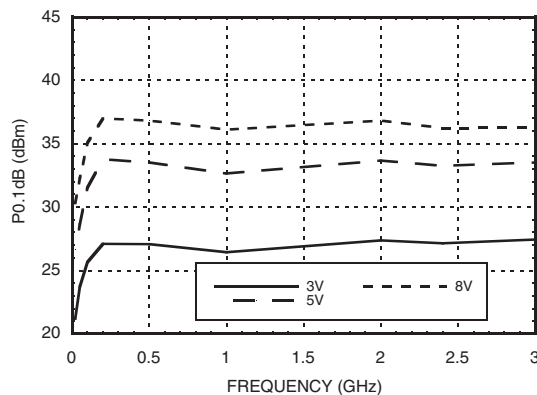

Input P1dB vs. Vdd

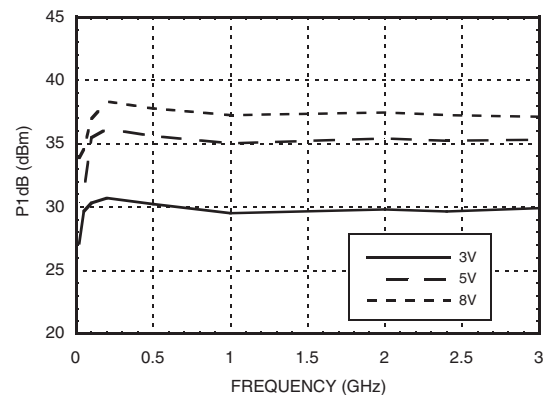

Information furnished by Analog Devices is believed to be accurate and reliable. However, no responsibility is assumed by Analog Devices for its use, nor for any infringements of patents or other rights of third parties that may result from its use. Specifications subject to change without notice. No license is granted by implication or otherwise under any patent or patent rights of Analog Devices. Trademarks and registered trademarks are the property of their respective owners.

For price, delivery, and to place orders: Analog Devices, Inc., One Technology Way, P.O. Box 9106, Norwood, MA 02062-9106 Phone: 781-329-4700 • Order online at www.analog.com Application Support: Phone: 1-800-ANALOG-D



**GaAs MMIC T/R SWITCH
DC - 3 GHz**

Input P0.1dB vs. Temperature

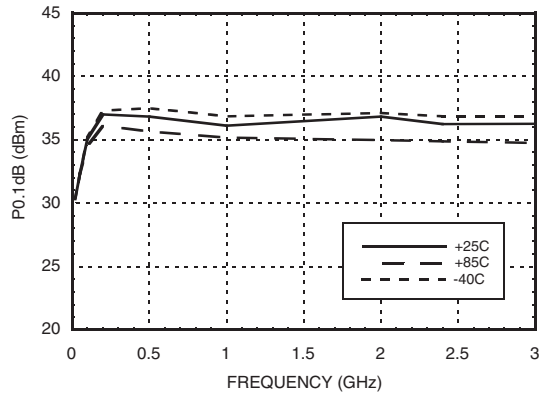

Input P1dB vs. Temperature

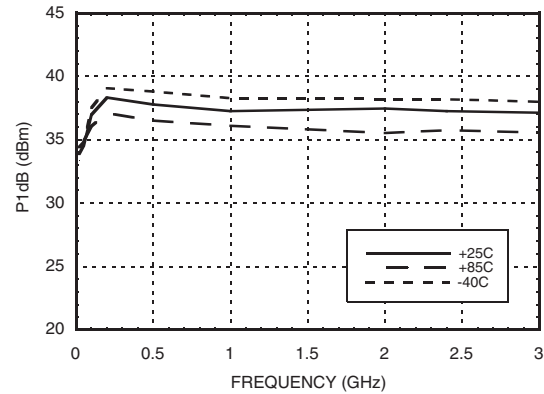

Input Third Order Intercept

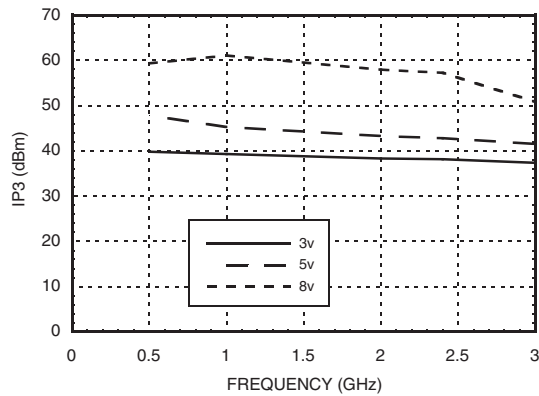

2nd & 3rd Harmonics @ 900 MHz

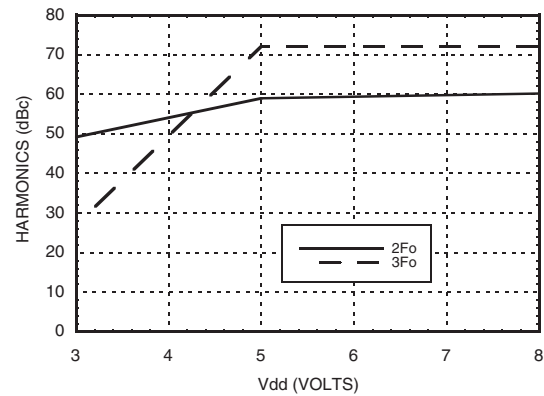

2nd & 3rd Harmonics @ 1900 MHz

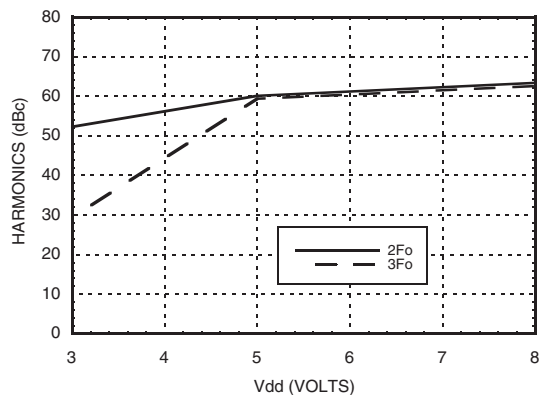

Absolute Maximum Ratings

Bias Voltage Range (Vdd)	-0.2 to +10 Vdc
Control Voltage Range (A & B)	-0.2 to +Vdd Vdc
Storage Temperature	-65 to +150 °C
Operating Temperature	-40 to +85 °C
ESD Sensitivity (HBM)	Class 1A



**ELECTROSTATIC SENSITIVE DEVICE
OBSERVE HANDLING PRECAUTIONS**

Information furnished by Analog Devices is believed to be accurate and reliable. However, no responsibility is assumed by Analog Devices for its use, nor for any infringements of patents or other rights of third parties that may result from its use. Specifications subject to change without notice. No license is granted by implication or otherwise under any patent or patent rights of Analog Devices. Trademarks and registered trademarks are the property of their respective owners.

For price, delivery, and to place orders: Analog Devices, Inc., One Technology Way, P.O. Box 9106, Norwood, MA 02062-9106 Phone: 781-329-4700 • Order online at www.analog.com Application Support: Phone: 1-800-ANALOG-D



GaAs MMIC T/R SWITCH DC - 3 GHz

Truth Table *Control Input Voltage Tolerances are ± 0.2 Vdc

Bias	Control Input*		Bias Current	Control Current		Signal Path State	
	A (Vdc)	B (Vdc)		Ia (uA)	Ib (uA)	RF to RF1	RF to RF2
3	0	0	30	-15	-15	OFF	OFF
3	0	Vdd	25	-25	0	ON	OFF
3	Vdd	0	25	0	-25	OFF	ON
5	0	0	110	-55	-55	OFF	OFF
5	0	Vdd	115	-100	-15	ON	OFF
5	Vdd	0	115	-15	-100	OFF	ON
10	0	0	380	-190	-190	OFF	OFF
10	0	Vdd	495	-275	-220	ON	OFF
10	Vdd	0	495	-220	-275	OFF	ON
5	-Vdd	Vdd	600	-600	225	ON	OFF
5	Vdd	-Vdd	600	225	-600	OFF	ON

Outline Drawing

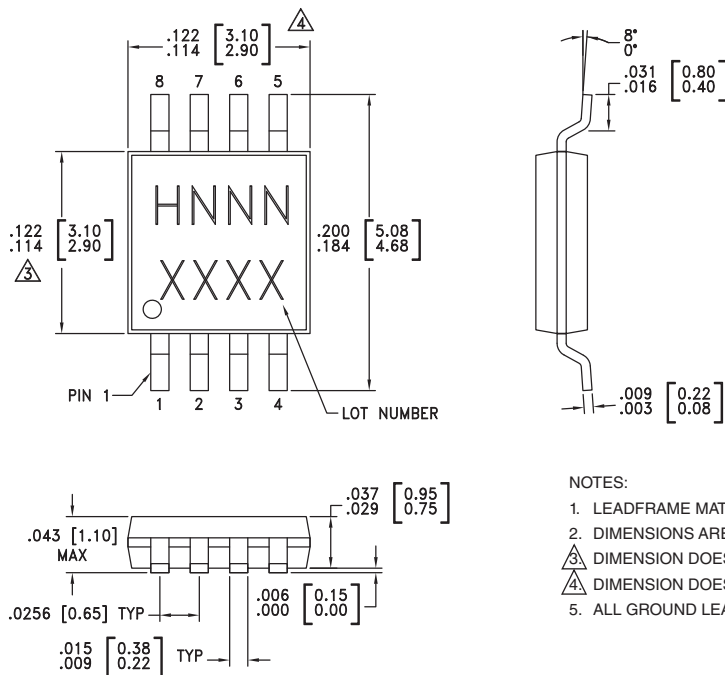

NOTES:

1. LEADFRAME MATERIAL: COPPER ALLOY
2. DIMENSIONS ARE IN INCHES [MILLIMETERS].
3. DIMENSION DOES NOT INCLUDE MOLDFLASH OF 0.15mm PER SIDE.
4. DIMENSION DOES NOT INCLUDE MOLDFLASH OF 0.25mm PER SIDE.
5. ALL GROUND LEADS MUST BE SOLDERED TO PCB RF GROUND.

Package Information

Part Number	Package Body Material	Lead Finish	MSL Rating	Package Marking ^[3]
HMC174MS8	Low Stress Injection Molded Plastic	Sn/Pb Solder	MSL1 ^[1]	H174 XXXX
HMC174MS8E	RoHS-compliant Low Stress Injection Molded Plastic	100% matte Sn	MSL1 ^[2]	H174 XXXX

[1] Max peak reflow temperature of 235 °C

[2] Max peak reflow temperature of 260 °C

[3] 4-Digit lot number XXXX

Information furnished by Analog Devices is believed to be accurate and reliable. However, no responsibility is assumed by Analog Devices for its use, nor for any infringements of patents or other rights of third parties that may result from its use. Specifications subject to change without notice. No license is granted by implication or otherwise under any patent or patent rights of Analog Devices. Trademarks and registered trademarks are the property of their respective owners.

For price, delivery, and to place orders: Analog Devices, Inc., One Technology Way, P.O. Box 9106, Norwood, MA 02062-9106 Phone: 781-329-4700 • Order online at www.analog.com Application Support: Phone: 1-800-ANALOG-D



**GaAs MMIC T/R SWITCH
DC - 3 GHz**

Pin Descriptions

Pin Number	Function	Description	Interface Schematic
1	A	See truth table and control voltage table.	
2	B	See truth table and control voltage table.	
3, 5, 8	RFC, RF1, RF2	This pin is DC coupled and matched to 50 Ohm. Blocking capacitors are required.	
4	Vdd	Supply Voltage.	
6, 7	GND	This pin must be connected to RF/DC ground.	

Typical Application Circuit

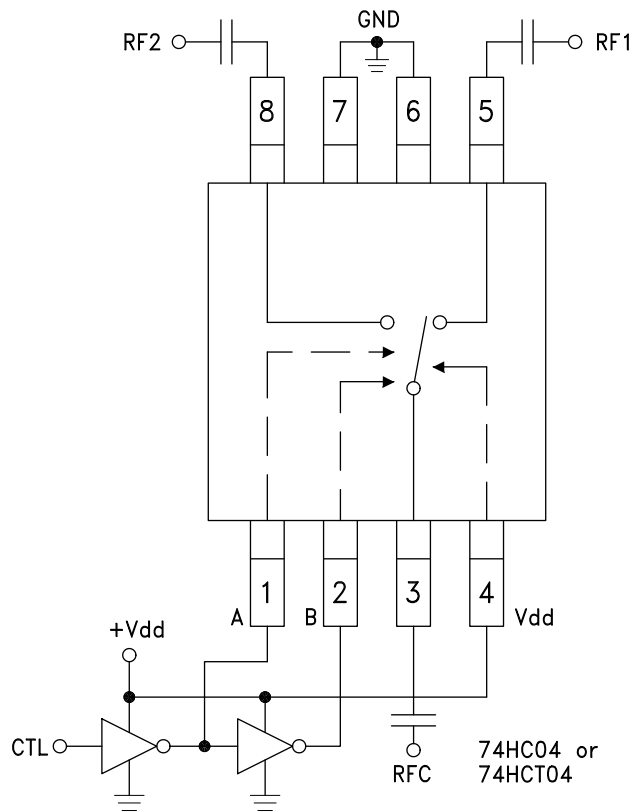

Notes:

1. Set logic gate and switch Vdd = +3V to +5V and use HCT series logic to provide a TTL driver interface.
2. Control inputs A/B can be driven directly with CMOS logic (HC) with Vdd of 3 to 8 Volts applied to the CMOS logic gates and to pin 4 of the RF switch.
3. DC Blocking capacitors are required for each RF port as shown. Capacitor value determines lowest frequency of operation.
4. Highest RF signal power capability is achieved with V set to +8V. The switch will operate properly (but at lower RF power capability) at bias voltages down to +3V.

Information furnished by Analog Devices is believed to be accurate and reliable. However, no responsibility is assumed by Analog Devices for its use, nor for any infringements of patents or other rights of third parties that may result from its use. Specifications subject to change without notice. No license is granted by implication or otherwise under any patent or patent rights of Analog Devices. Trademarks and registered trademarks are the property of their respective owners.

For price, delivery, and to place orders: Analog Devices, Inc., One Technology Way, P.O. Box 9106, Norwood, MA 02062-9106 Phone: 781-329-4700 • Order online at www.analog.com Application Support: Phone: 1-800-ANALOG-D



Evaluation Circuit Board

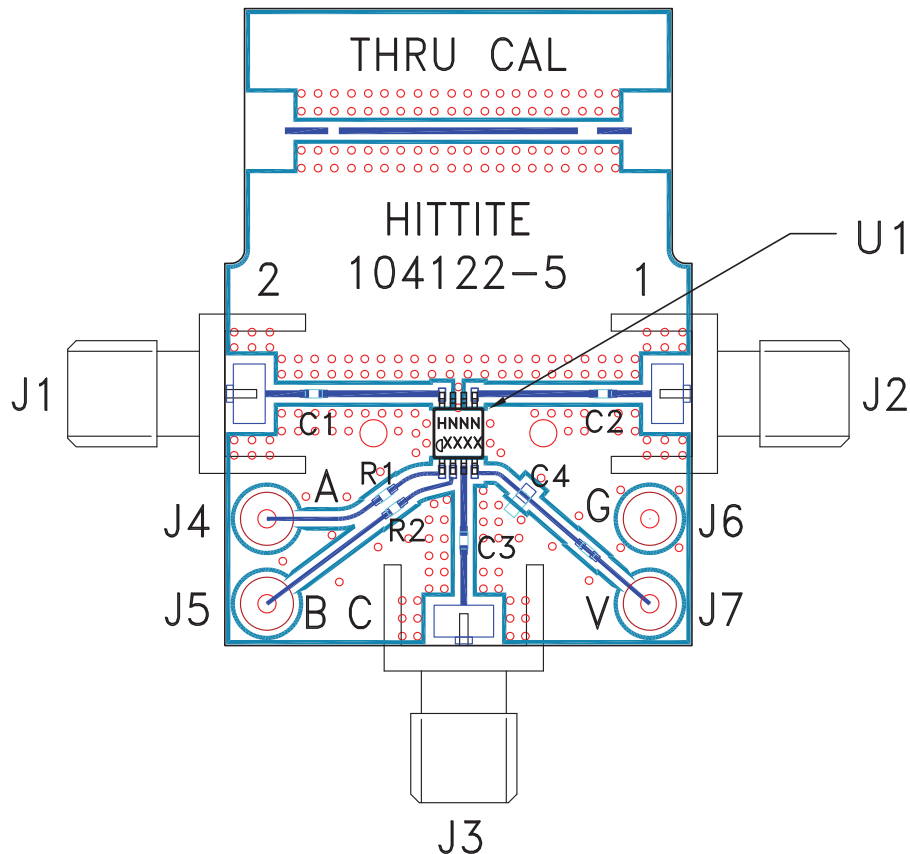

List of Materials for Evaluation PCB 104124 [1]

Item	Description
J1 - J3	PCB Mount SMA RF Connector
J4 - J7	DC Pin
C1 - C3	100 pF capacitor, 0402 Pkg.
C4	10,000 pF capacitor, 0603 Pkg.
U1	HMC174MS8(E) T/R Switch
PCB [2]	104122 Evaluation PCB

[1] Reference this number when ordering complete evaluation PCB

[2] Circuit Board Material: Rogers 4350

The circuit board used in the final application should be generated with proper RF circuit design techniques. Signal lines at the RF port should have 50 ohm impedance and the package ground leads should be connected directly to the ground plane similar to that shown above. The evaluation circuit board shown above is available from Hittite Microwave Corporation upon request.

Looking for pricing, stock, or lifecycle information?

Click below to explore more details on WIN SOURCE:

 [View HMC174MS8TR on WIN SOURCE](#)

 [Analog Devices Inc. Information](#)

Optimize Your Supply Chain with WIN SOURCE Solutions

-  Global Sourcing Solution
-  Obsolete Management
-  Cost Control Management
-  Shortage Management
-  Alternative Solution
-  Excess Inventory Management