

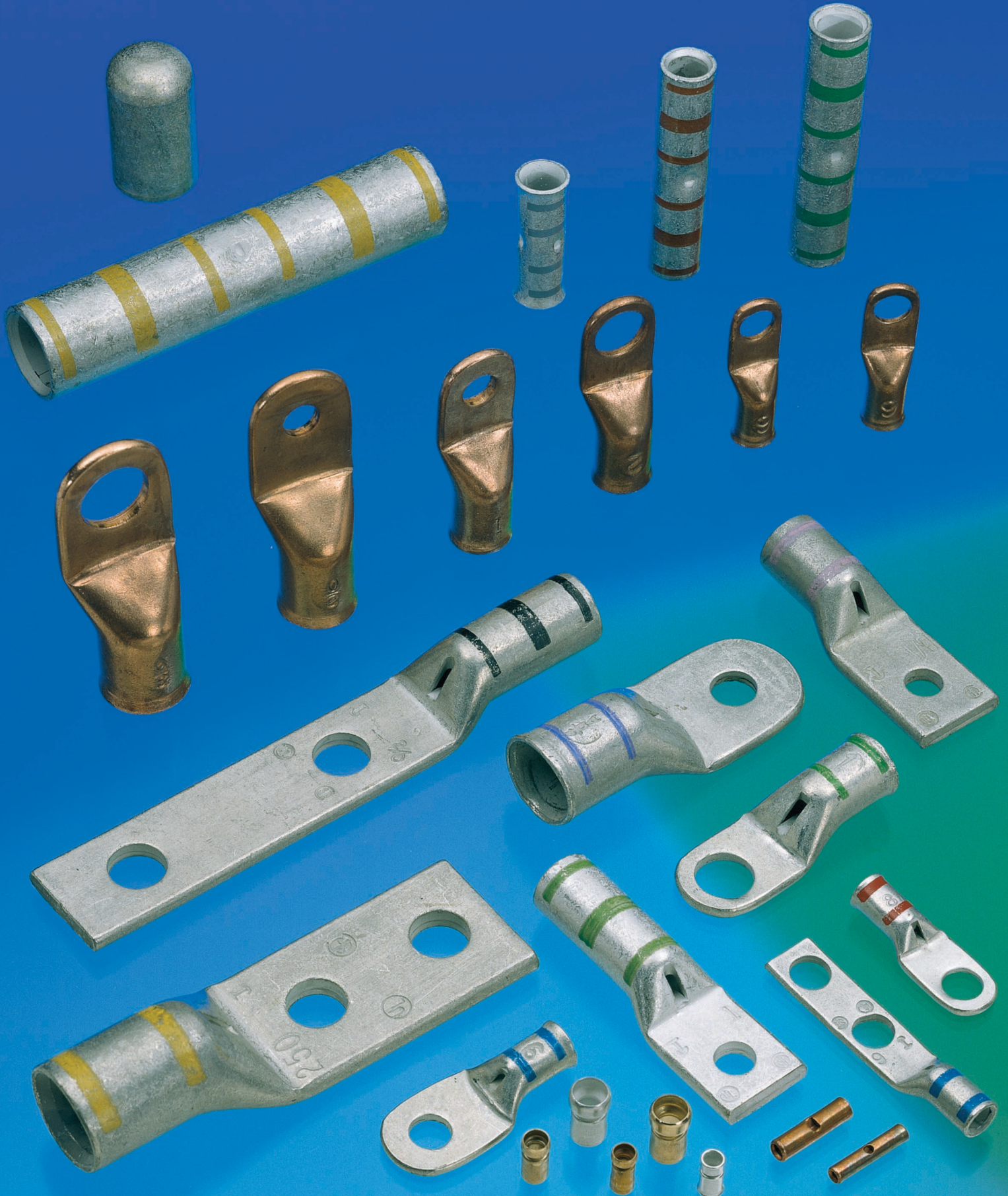

THE DATASHEET OF
1526596-2





Introduction

Product Facts

Heavy Duty Seamless Electrical Lugs

- High conductivity ETP copper
- Utilize seamless drawn body
- Flared wire barrel
- Copper and tin plating available
- Sight hole versions available for wire inspection
- Multiple tongue widths available
- Bent tongues available at angles up to 90°
- Many part numbers are UL listed

Heavy Duty Seamless Electrical Splices

- Utilize seamless tubular body
- Flared or chamfered wire barrel entry
- Dimpled wire stop for proper placement
- Tin plating

Industrial Electrical Lugs

- High conductivity ETP copper material
- Utilize seamless drawn body
- Tin plating
- Flared wire barrel
- Sight hole for wire inspection
- Color coding for crimp identification

Copper Compression Lugs and Splices

- Tubular copper body
- Sight hole for wire inspection
- Single and double stud hole available
- Long and short crimp barrel available
- Color coding for crimp identification
- Chamfered wire barrel entry
- Many part numbers are UL listed

Drawn Sleeves

- Capabilities to produce a wide range of custom drawn sleeves for electrical and electronic applications

The Heavy Duty Seamless and Copper Compression Lug and Splice line provides a robust terminal line for applications in the many industries. The product is used in applications including industrial and welding equipment, transportation/marine cable harness, and general-purpose harnesses. The Heavy Duty Seamless line utilizes deep-draw stamping technology to create a robust terminal without butted seams along the wire barrel or along the outer edge of the ring tongue. The Heavy Duty Splice line offers butt splice versions with either flared or chamfered wire barrels for ease of wire entry and dimpled wire stops to assist in proper wire placement.

The Copper Compression Lug and Splice line is a formed tubular line for use on cable assemblies in

Commercial equipment and Industrial machinery. The thicker tongue and wire barrel of this line provide added strength and rigidity for more challenging applications.

The Battery Lug and Splice line offers the thickest material and strength for your industrial equipment and transportation harness applications.

Tyco Electronics has extensive drawn sleeve capabilities to help meet your customized electrical sleeve needs. The company manufactures specialized sleeves used in general electrical applications and electronic components. Tyco Electronics has the capability to manufacture sleeves in a range of copper alloys and has extensive post electroplating capabilities. Contact us to review your application and discuss the benefits we can provide.

Need more information?

Call Technical Support at the numbers listed below.

Technical Support is staffed with specialists well versed in all Tyco Electronics products. They can provide you with:

- Technical support
- Catalogs
- Technical Documents
- Product Samples
- Tyco Electronics Authorized Distributor Locations

© Copyright 2002 by Tyco Electronics Corporation. All Rights Reserved.
AMP and TYCO are trademarks.

Table of Contents

Product Descriptions4-7

Stud Hole Size Chart/UL486A Chart8

Deep-Drawn Sleeves and Terminals

 Capabilities9

 Sleeve Illustrations and Part Numbers10

 Design Worksheet11

Heavy Duty Seamless Lugs and Splices

Seamless Ring Lugs12, 13

 8 AWG to 250 MCM

Seamless Ring Lugs with Sight Hole14, 15

 8 AWG to 250 MCM

Seamless Angled Ring Lugs16, 17

 8 AWG to 250 MCM

Seamless Angled Ring Lugs with Sight Hole18

 8 AWG to 250 MCM

Seamless Butt Splices19

 8 AWG to 4/0

Industrial Electrical Lugs and Splices

Industrial Lugs20

 8 AWG to 4/0

Industrial Butt Splices21

 8 AWG to 4/0

Copper Compression Lugs and Splices

Standard Barrel Lug with One Stud Hole22

 8 AWG to 500 MCM

Standard Barrel Lug with Two Stud Holes23

 8 AWG to 500 MCM

Long Barrel Lug with One Stud Hole24

 8 AWG to 500 MCM

Long Barrel Lug with Two Stud Holes25

 8 AWG to 500 MCM

Standard Barrel Butt Splices26

 8 AWG to 500 MCM

Long Barrel Butt Splices27

 8 AWG to 500 MCM

Design Worksheet28

Heavy Duty Starter/Battery Lugs and Splices

Super Lugs29

 4 AWG to 4/0

Super Butt Splices29

 4 AWG to 4/0

Crimp Tooling30

AMP to Former AET Part Number Cross Reference31-33

Former AET to AMP Part Number Cross Reference34-36

Part Number Index37-39

Heavy Duty Seamless Electrical Lugs

This line is made from high conductivity Electrolytic Tough Pitch (ETP) copper in a unique deep drawing process that enables the seamless characteristics. The seamless design provides advantages in a wide range of environmental and corrosive applications. The product incorporates a flared wire barrel to ease wire entry. The product has the wire gauge stamped on barrel for ease of identification. Different ring tongue pad widths and stud hole clearances are available for nearly any application. Versions with sight holes in the barrel are available to assist in wire inspection after crimping. Different angled versions are available to meet your many challenging applications, and custom bend angles can be quoted upon request. The product is available in copper or tin-plated copper varieties. The product is available in wire ranges from 8 AWG to 250 MCM.

**Angled Ring Tongue****Expanded Tongue**

Heavy Duty Seamless Butt Splices

This line incorporates high conductivity ASTM B-152 tubular copper material for a series of butt splices to meet most applications. The splices are available with either flared or chamfered barrels to ease in wire entry. Dimpled wire stop features are incorporated in each barrel to assist in proper wire placement for crimping. All products in this line are tin plated to provide additional corrosion protection.

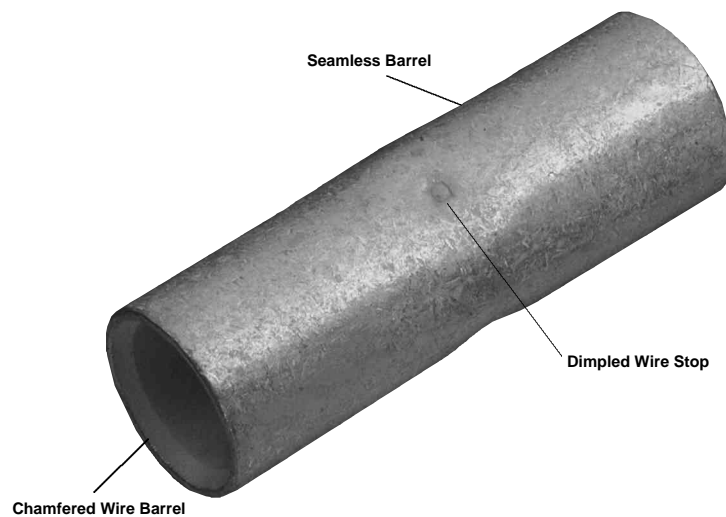
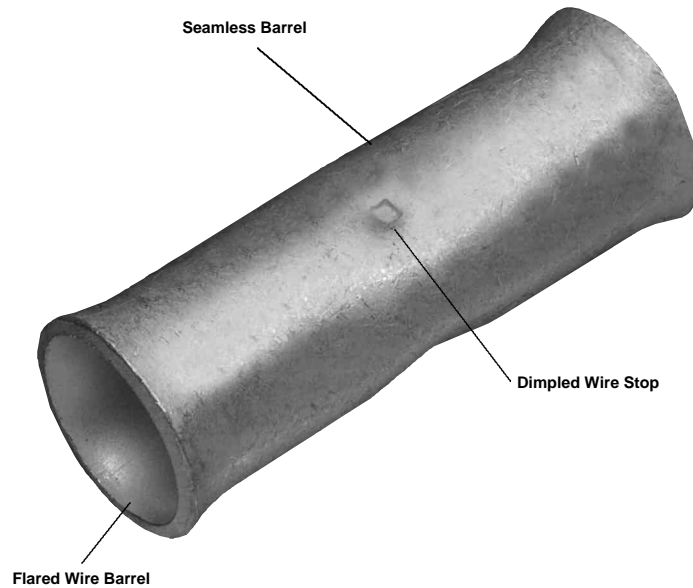

Industrial Electrical Lugs and Butt Splices

This line is made from high conductivity Electrolytic Tough Pitch (ETP) copper in a unique deep drawing process that enables the seamless characteristics. The seamless design provides advantages in a wide range of environmental and corrosive applications. The products in this line all have the wire size stamped on the barrel, a sight hole for wire inspection, tin plating, and coded barrels for wire and crimp identification. The product line is available in wire ranges from 8 AWG to 4/0.

The Butt Splices incorporate the same basic features as the standard Seamless Butt Splice line and are tin plated with color coded bands to wire and crimp identification.

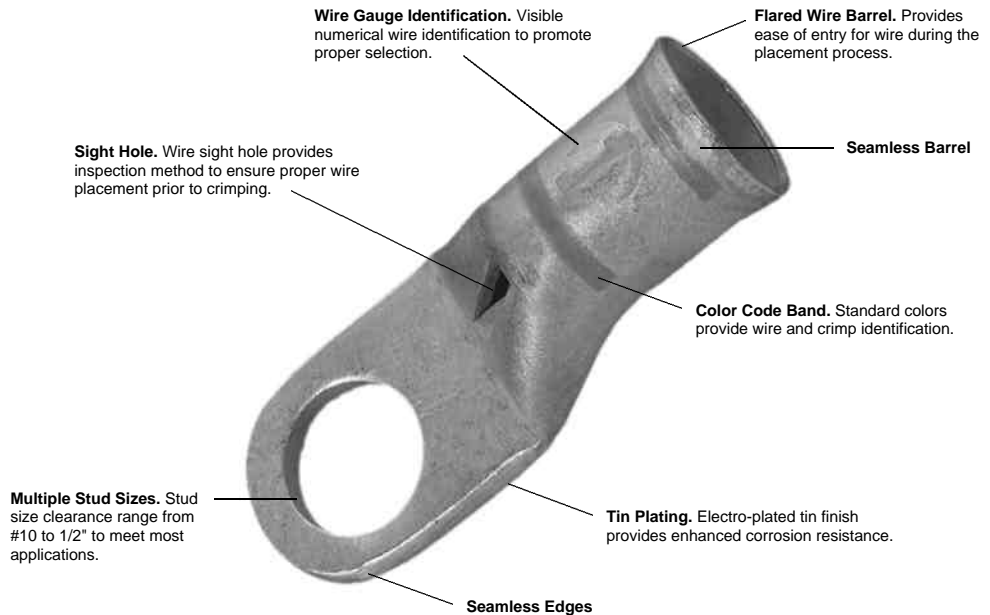

Copper Compression Lugs and Butt Splices

This line utilizes high conductivity ASTM B-75 tubular copper for a series of Copper Compression Lugs and Butt Splices for added strength and rigidity.

The Compression Lugs are available in single or double stud hole versions. A wide variety of stud hole sizes are available to meet most applications. The product line incorporates features including a chamfered wire barrel to ease wire entry, wire identification on the tongue, and a sight hole for wire inspection. The wire barrels are available in standard or long barrel to provide either a single or double crimp depending on the application. Each wire barrel has a color code band to identify the wire and crimp identification. The product line is available in wire ranges from 8 AWG to 500 MCM.



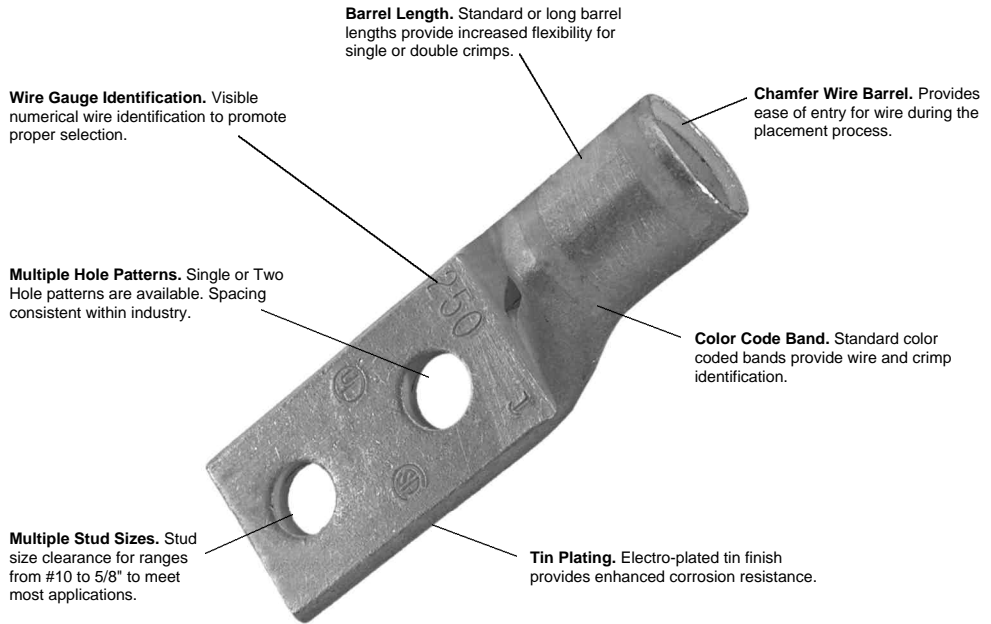





The Copper Compression Butt Splice line utilizes tubular copper for a series of standard and long barrel splices. All splices in this line have beneficial features including chamfered wire barrels and color coding for wire and crimp identification. Standard barrel products allow one crimp per wire, and long barrel products allows for two crimps for each wire. The product is available in wire ranges from 8 AWG to 500 MCM.







Stud Size Chart

Use to Select Proper Size Terminal

The chart shows sizes and dimensions of various studs and the corresponding terminal stud hole sizes used with AMP devices. For example, with stud #5 (.125 [3.18] Diameter), use AMP terminal device listed for #5 stud (.132 [3.35] Hole Diameter). Terminal stud hole sizes may easily be checked by fitting sample terminal to black circle.

Stud Size		Stud Dia.		Typical Terminal Stud Hole Diameter
U.S. Cust.	Metric			
#6	M3.5	.138 3.51		.147 ± .005 3.73 ± 0.13
#8	M4	.164 4.17		.173 ± .005 4.39 ± 0.13
#10	—	.190 4.83		.212 ± .005 5.38 ± 0.13
#12	—	.216 5.49		.225 ± .005 5.72 ± 0.13
#14	—	.242 6.15		.252 ± .005 6.40 ± 0.13
1/4"	M6	.250 6.35		.275 ± .005 6.99 ± 0.13
5/16"	M8	.312 7.92		.336 ± .005 8.53 ± 0.13
3/8"	—	.375 9.53		.405 ± .005 10.29 ± 0.13

Stud Size		Stud Dia.		Typical Terminal Stud Hole Diameter
U.S. Cust.	Metric			
7/16"	—	.437 11.10		.463 ± .005 11.76 ± 0.13
1/2"	M12	.500 12.70		.525 ± .005 13.34 ± 0.13
5/8"	M16	.625 15.88		.645 ± .005 16.38 ± 0.13
3/4"	—	.750 19.05		.780 ± .005 19.81 ± 0.13

Description of UL 486A Test Procedures and Requirements for Terminals

Wire Size Range AWG 8 to 500 MCM

Test Sequences

Test Group 1

Mechanical Sequence

1. Secureness
2. Pullout

Test Group 2

Mechanical Sequence

1. Secureness
2. Static Heat
3. Pullout

Pullout Test Requirements

Terminal must not be separate from wire when subjected to the listed load for one minute.

Wire Size AWG	Pullout Force (lbs.)
8	90
6	100
4	140
2	180
1/0	250
2/0	300
3/0	350
4/0	450
250	500
300	550
350	600
400	650
500	800

Note: Testing conducted on non-plated copper wire with UL approved insulation.

Static Heat Test Requirements

Wire Size AWG	Test Current (Amperes)
6	95
4	125
2	170
1/0	230
2/0	265
3/0	310
4/0	360
250	405
300	445
350	505
400	545
500	620

Requirement — Connector temperatures must not exceed the ambient temperature plus 50°C [90°F] after stability is attained.

Stability — A test sample is considered to have attained a stable temperature when three readings taken at not less than 10 minute intervals show no more than a 2°C [3.6°F] variation between any two readings.

Deep-Drawn Sleeve and Terminal Capabilities

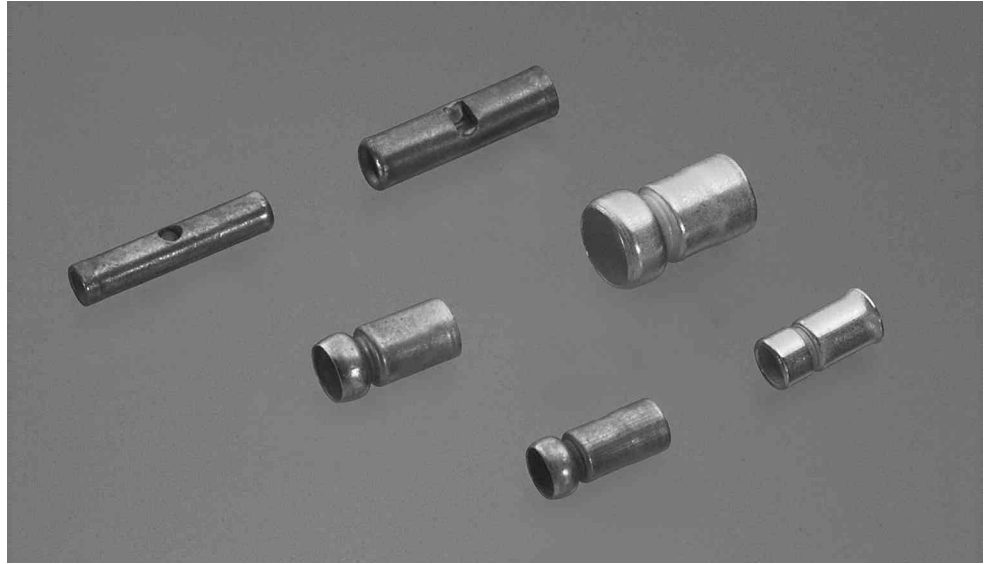

With the acquisition of American Electrical Terminal Co. in 2001, Tyco Electronics added extensive manufacturing capability for fabrication of high-volume precision seamless deep-drawn sleeves, thimbles, and terminal bodies. The deep-drawing process utilizes specialized high-speed equipment to extrude a wide range of materials into

customized electrical and electronic component bodies. Post-processing capabilities within Tyco include precision cleaning, secondary forming, and heat treatment processes. Furthermore, by utilizing the extensive precious and non-precious metal plating capabilities of Tyco Electronics, you can obtain completed components cost effectively from one source.

The table on page 10 lists some standard components and configurations available. The worksheet on page 11 can be used to specify a custom design for your application and receive a quote from Tyco Electronics.

Drawn Sleeves and Thimbles

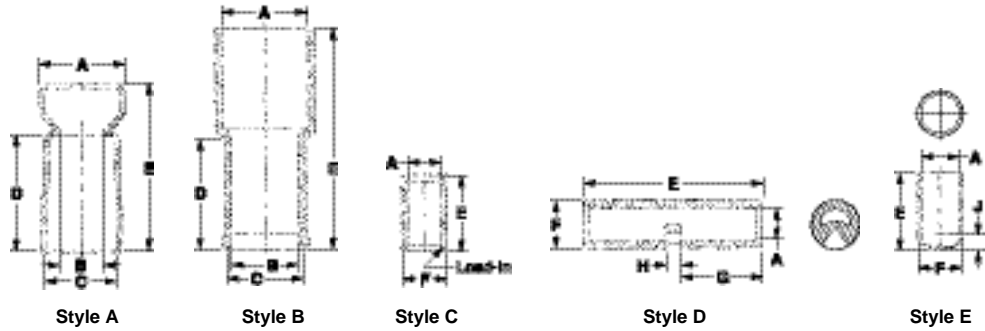
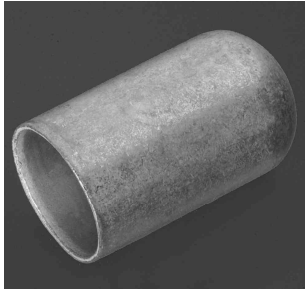

Drawn Funneled Sleeve

Part Number	Style	A Dia. Min.	B Dia. Min.	C Dia. Min.	D Length Max.	E Length Max.	Material	Treatment	Finish
1527526-2	A	.224 5.69	.150 3.81	.223 5.66	.255 6.48	.445 11.30	Brass	—	Tin
1527529-2	A	.224 5.69	.150 3.81	.223 5.66	.255 6.48	.445 11.30	Brass	Annealed	Tin
1527530-2	A	.157 3.99	.100 2.54	.161 4.09	.263 6.68	.378 9.60	Brass	—	Tin
1527531-2	A	.157 3.99	.100 2.54	.161 4.09	.258 6.55	.378 9.60	Brass	Annealed	Tin
1527539-2	A	.138 3.51	.080 2.03	.138 3.51	.255 6.48	.370 9.40	Brass	Annealed	Tin
1527546-2	A	.138 3.51	.080 2.03	.138 3.51	.255 6.48	.370 9.40	Brass	—	Tin

Drawn Sleeve

Part Number	Style	A Dia. Min.	B Dia. Min.	C Dia. Min.	D Length Max.	E Length Max.	Finish
1527548-2	B	.093 2.36	.074 1.88	.080 2.03	.255 6.48	.130 3.30	Tin

Drawn Inserts

Part Number	Style	A Dia. Min.	F Dia. Max.	E Length Max.	Material	Treatment	Finish
1527514-2	C	.150 3.81	.202 5.13	.340 8.64	Steel	Annealed	Zinc
1527516-2	C	.088 2.24	.135 3.43	.310 7.87	Steel	Annealed	Zinc
1527523-1	C	.150 3.81	.202 5.13	.340 8.64	Steel	Annealed	—

Drawn Butt Connector Barrels

Part Number	Style	Wire Range	A Dia. Min.	F Dia. Max.	E Length Max.	G Length Nominal	H Nominal	Material	Treatment	Finish
1527473-2	D	12-10	.140 3.56	.220 5.59	.820 20.83	.370 9.40	.065 1.65	Copper	Annealed	Tin
1527480-2	D	16-14	.095 2.41	.160 4.06	.670 17.02	.300 7.62	.065 1.65	Copper	Annealed	Tin
1527555-2	D	22-18	.060 1.52	.127 3.23	.633 16.08	.280 7.11	.065 1.65	Copper	Annealed	Tin

Drawn Thimbles

Part Number	Style	A Dia. Min.	F Dia. Max.	E Length Max.	J Nominal	Material	Finish
1526950-2	E	.645 16.38	.720 18.29	1.270 32.26	.250 6.35	Copper	Tin

CUSTOMER INFORMATION: Review with Tyco Electronics Sales Engineer, Tyco Electronics Authorized Distributor, or fax to Tyco Electronics Technical Support.

Company Name _____ Your Name _____
 Address _____ City/State _____
 Telephone Number _____ Fax Number _____

SLEEVE STYLE

STRAIGHT 

FUNNELED 

PRODUCTION REQUIREMENTS

INITIAL QTY. _____ DUE DATE _____
 1ST YEAR QTY. _____ PROGRAM _____
 2ND YEAR QTY. _____ LIFE _____
 TARGET PRICE _____

CUSTOM SKETCH AREA
(Show Basic Shape & Dimensions)

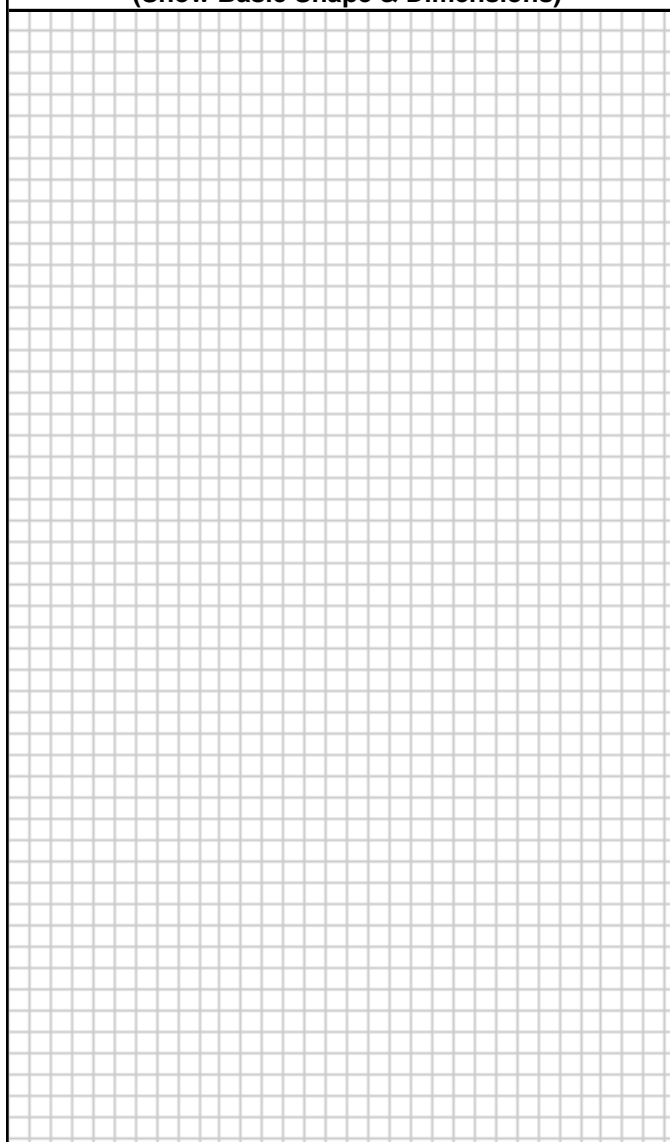

MATERIAL

BRASS SPECIFICATION _____
 COPPER _____
 STEEL _____
 OTHER _____



THICKNESS

.008" .010" .012"
 OTHER _____

PLATING

NONE TIN OTHER _____

SHAPE (LENGTH)

THIMBLE  TUBULAR 

SHAPE (WIDTH)

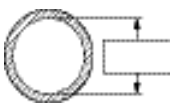
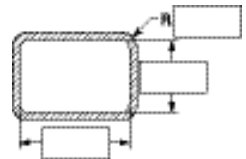
ROUND  SQUARE/RECTANGULAR 

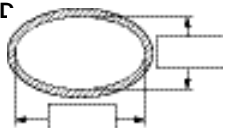
OVALIZED 

Fax or Mail to:
Attn: Tyco Electronics Technical Support, 2800 Fulling Mill Road, Middletown, PA 17057
Fax Number: 717-986-7575 Phone Number: 1-800-522-6752

Route to Product Manager GPL D90

Heavy Duty Seamless Lugs and Splices

Seamless Ring Lugs
Wire Size Range
8 AWG to 1/0

Material

Terminal Body — Copper per ASTM B-152

Plating — Tin per ASTM B-545

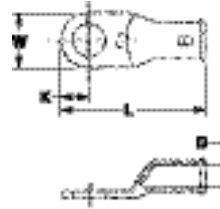

Wire Size	Dimensions				Stud Size	Part Numbers			
	D	L	W	K		Plain Copper	Tin Plated		
8	.185 4.70	1.20 30.48	.445 11.30	.235 5.97	10	1526109-1	1526109-2		
					1/4	1526115-1	1526115-2		
					5/16	1526122-1	1526122-2		
		1.305 33.15	.605 15.37	.315 8.00	1/4	1526128-1	1526128-2		
					5/16	1526134-1	1526134-2		
					3/8	1526142-1	1526142-2		
	1.48 37.59	.765 19.45	.395 10.03	3/8	1526148-1	1526148-2			
				1/2	1526154-1	1526154-2			
				10	1526160-1	1526160-2			
	6	.232 5.89	1.27 32.26	.445 11.30	.235 5.97	1/4	1526166-1	1526166-2	
						5/16	1526173-1	1526173-2	
						1/4	1526181-1	1526181-2	
1.410 35.81			.605 15.37	.315 8.00	5/16	1526187-1	1526187-2		
					3/8	1526193-1	1526193-2		
					3/8	1526209-1	1526209-2		
1.55 39.37		.765 19.45	.395 10.03	1/2	1526217-1	1526217-2			
				10	1526223-1	1526223-2			
				1/4	1526229-1	1526229-2			
4		.286 7.26	1.50 38.1	.525 13.33	.275 6.98	5/16	1526235-1	1526235-2	
						3/8	1526242-1	1526242-2	
						5/16	1526251-1	1526251-2	
	1.53 38.89		.625 15.88	.325 8.25	3/8	1526258-1	1526258-2		
					3/8	1526267-1	1526267-2		
					1/2	1526282-1	1526282-2		
	1.68 42.85	.765 19.45	.395 10.03	1/4	1526290-1	1526290-2			
				5/16	1526397-1	1526397-2			
				3/8	1526405-1	1526405-2			
				1.75 44.45	.755 19.18	.395 10.03	3/8	1526415-1	1526415-2
							1/2	1526431-1	1526431-2
							1/4	1526437-1	1526437-2
1	.360 9.14	1.72 43.69	.655 16.64	.335 8.51	3/8	1526452-1	1526452-2		
					1/2	1526459-1	1526459-2		
					3/8	1526465-1	1526465-2		
		1.83 46.48	.755 19.18	.395 10.03	1/2	1526479-1	1526479-2		
					1/4	1526490-1	1526490-2		
					5/16	1526596-1	1526596-2		
1/0	.407 10.33	1.83 46.48	.725 18.41	.385 9.78	3/8	1526704-1	1526704-2		
					1/2	1526713-1	1526713-2		
					3/8	1526719-1	1526719-2		
		1.90 48.41	.825 20.96	.425 10.80	1/2	1526731-1	1526731-2		

Heavy Duty Seamless Lugs and Splices (Continued)

Seamless Ring Lugs

(Continued)

Wire Size Range
2/0 AWG to 250 MCM

Material

Terminal Body — Copper per ASTM B-152

Plating — Tin per ASTM B-545

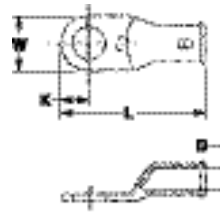

Wire Size	Dimensions				Stud Size	Part Numbers	
	D	L	W	K		Plain Copper	Tin Plated
2/0	.461 11.71	2.06 52.37	8.15 20.70	.425 10.80	1/4	1526738-1	1526738-2
					5/16	1526745-1	1526745-2
					3/8	1526758-1	1526758-2
					1/2	1526781-1	1526781-2
3/0	.511 12.98	2.16 54.86	.895 22.73	.465 11.81	1/4	1526793-1	1526793-2
					5/16	1526799-1	1526799-2
					3/8	1526805-1	1526805-2
					1/2	1526819-1	1526819-2
4/0	.559 14.20	2.35 59.69	.985 25.02	.505 12.83	1/4	1526830-1	1526830-2
					5/16	1526837-1	1526837-2
					3/8	1526844-1	1526844-2
					1/2	1526852-1	1526852-2
					3/8	1526863-1	1526863-2
					1/2	1526873-1	1526873-2
250 MCM	.625 15.87	2.39 60.71	1.035 26.29	.525 13.33	5/8	1526883-1	1526883-2
					3/8	1526892-1	1526892-2
					1/2	1526911-1	1526911-2
					5/8	1526922-1	1526922-2
250 MCM	.685 17.40	2.65 67.46	1.20 30.55	.605 15.37	3/8	1526928-1	1526928-2
					1/2	1526934-1	1526934-2
					5/8	1526941-1	1526941-2

Heavy Duty Seamless Lugs and Splices (Continued)

Seamless Ring Lugs with Sight Holes

Wire Size Range
8 AWG to 1/0

Material

Terminal Body — Copper per ASTM B-152

Plating — Tin per ASTM B-545



Wire Size	Dimensions				Stud Size	Part Numbers	
	D	L	W	K		Plain Copper	Tin Plated
8	.185 4.70	1.20	.445	.235	10	1526110-1	1526110-2
		30.48	11.30	5.97	1/4	1526116-1	1526116-2
					5/16	1526123-1	1526123-2
					1/4	1526129-1	—
					5/16	1526135-1	1526135-2
					3/8	1526143-1	1526143-2
				3/8	1526149-1	—	
				1/2	1526155-1	1526155-2	
				10	1526161-1	1526161-2	
				1/4	1526167-1	1526167-2	
				5/16	1526174-1	1526174-2	
				1/4	1526182-1	1526182-2	
6	.232 5.89	1.27	.445	.235	10	1526161-1	1526161-2
		32.26	11.30	5.97	1/4	1526167-1	1526167-2
					5/16	1526174-1	1526174-2
					1/4	1526182-1	1526182-2
					5/16	1526188-1	1526188-2
					3/8	1526194-1	1526194-2
				3/8	1526210-1	1526210-2	
				1/2	1526218-1	1526218-2	
				10	1526224-1	1526224-2	
				1/4	1526230-1	1526230-2	
				5/16	1526236-1	1526236-2	
				3/8	—	1526243-2	
4	.286 7.26	1.53	.625	.325	5/16	1526252-1	1526252-2
		38.89	15.88	8.26	3/8	1526259-1	1526259-2
					3/8	1526268-1	1526268-2
					1/2	1526283-1	1526283-2
					1/4	1526291-1	1526291-2
					5/16	1526398-1	1526398-2
				3/8	—	1526406-2	
				3/8	1526416-1	1526416-2	
				1/2	1526432-1	1526432-2	
				1/4	—	1526438-2	
				5/16	1526443-1	1526443-2	
				3/8	1526453-1	1526453-2	
2	.336 8.53	1.62	.615	.325	3/8	1526466-1	1526466-2
		41.27	15.62	8.26	1/2	1526480-1	1526480-2
					1/4	1526491-1	1526491-2
					5/16	1526597-1	1526597-2
					3/8	1526705-1	1526705-2
					1/2	1526714-1	1526714-2
				3/8	1526466-1	1526466-2	
				1/2	1526480-1	1526480-2	
				1/4	1526491-1	1526491-2	
				5/16	1526597-1	1526597-2	
				3/8	1526705-1	1526705-2	
				1/2	1526714-1	1526714-2	
1/0	.407 10.33	1.83	.725	.385	3/8	1526720-1	1526720-2
		46.48	18.41	9.78	1/2	1526732-1	1526732-2
					1/2	1526732-1	1526732-2
					1/2	1526732-1	1526732-2
					1/2	1526732-1	1526732-2
					1/2	1526732-1	1526732-2

Heavy Duty Seamless Lugs and Splices (Continued)

Seamless Ring Lugs with Sight Holes (Continued)

Wire Size Range
2/0 AWG to 250 MCM

Material

Terminal Body — Copper per ASTM B-152

Plating — Tin per ASTM B-545



Wire Size	Dimensions				Stud Size	Part Numbers	
	D	L	W	K		Plain Copper	Tin Plated
2/0	.461 11.71	2.06 52.37	.815 20.70	.425 10.80	1/4	1526739-1	1526739-2
					5/16	1526746-1	1526746-2
	3/8	1526759-1	1526759-2				
	1/2	1526782-1	1526782-2				
3/0	.511 12.98	2.16 54.86	.895 22.73	.465 11.81	1/4	—	1526794-2
					5/16	1526800-1	1526800-2
	3/8	1526806-1	1526806-2				
	1/2	1526820-1	1526820-2				
4/0	.559 14.20	2.35 59.69	.985 25.02	.505 12.83	1/4	1526831-1	1526831-2
					5/16	—	1526838-2
	3/8	—	1526845-2				
	1/2	1526853-1	1526853-2				
	.590 14.99	2.39 60.71	1.035 26.29	.525 13.34	3/8	1526862-1	1526862-2
					1/2	1526874-1	1526874-2
5/8	1526884-1	1526884-2					
.625 15.87	2.46 62.68	1.085 27.56	.555 14.10	3/8	1526893-1	1526893-2	
				1/2	1526912-1	1526912-2	
5/8	1526923-1	1526923-2					
250 MCM	.685 17.40	2.65 67.46	1.20 30.55	.605 15.37	3/8	1526929-1	1526929-2

Heavy Duty Seamless Lugs and Splices (Continued)

Seamless Angled Ring Lugs Wire Size Range 8 AWG to 1

Material

Terminal Body — Copper per ASTM B-152

Plating — Tin per ASTM B-545

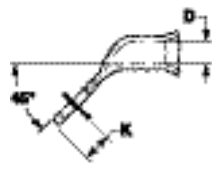

45° Bend



90° Bend



Wire Size	Dimensions			Stud Size	Angle	Part Numbers		
	D	W	K			Plain Copper	Tin Plated	
8	.185 4.70	.445 11.30	.235 5.97	10	45°	1526111-1	1526111-2	
				1/4	45°	1526117-1	1526117-2	
				1/4	90°	1526118-1	1526118-2	
		1/2	.765 19.45	.395 10.03	1/2	90°	1526157-1	1526157-2
					1/4	90°	1526163-1	1526163-2
						45°	1526168-1	1526168-2
6	.232 5.89	.445 11.30	.235 5.97	1/4	45°	1526169-1	1526169-2	
				1/4	90°	1526190-1	1526190-2	
				3/8	90°	1526196-1	1526196-2	
		1/2	.605 15.37	.315 8.00	1/2	90°	1526199-1	1526199-2
					1/2	90°	1526220-1	1526220-2
						45°	1526232-1	1526232-2
4	.286 7.26	.525 13.34	.275 6.99	1/4	90°	1526237-1	1526237-2	
				3/8	90°	1526245-1	—	
				5/16	45°	1526253-1	—	
		3/8	.625 15.88	.325 8.26	3/8	45°	—	1526272-2
					3/8	90°	—	1526273-2
					1/2	45°	—	1526284-2
2	.336 8.53	.765 19.45	.395 10.03	1/2	90°	—	1526285-2	
				1/4	90°	1526293-1	1526293-2	
					45°	1526399-1	—	
		5/16	.615 15.62	.325 8.25	5/16	45°	1526400-1	1526400-2
					3/8	90°	1526408-1	—
					1/2	90°	1526434-1	1526434-2
1	.360 9.14	.755 19.18	.395 10.03	5/16	90°	—	1526445-2	
				3/8	45°	—	1526454-2	
					3/8	90°	1526455-1	1526455-2
		1/2	.655 16.64	.335 8.51	1/2	45°	—	1526486-2
					1/2	45°	—	1526487-2
						90°	—	1526487-2

Heavy Duty Seamless Lugs and Splices (Continued)

Seamless Angled Ring Lugs

(Continued)

Wire Size Range
1/0 AWG to 250 MCM

Material

Terminal Body — Copper per ASTM B-152

Plating — Tin per ASTM B-545



Wire Size	Dimensions			Stud Size	Angle	Part Numbers					
	D	W	K			Plain Copper	Tin Plated				
1/0	.407 10.33	.725 18.42	.385 9.78	3/8	45°	1526706-1	1526706-2				
					90°	1526707-1	1526707-2				
	1/2	45°	—	1526715-2							
		90°	1526716-1	1526716-2							
2/0	.461 11.71	.815 20.70	.425 10.80	5/16	45°	—	1526747-2				
				3/8	45°	1526764-1	1526764-2				
					90°	1526769-1	1526769-2				
				1/2	45°	1526783-1	1526783-2				
					90°	1526784-1	1526784-2				
				3/0	.511 12.98	.895 22.73	.465 11.81	1/4	90°	—	1526796-2
3/8	45°	1526809-1	—								
	90°	1526810-1	1526810-2								
1/2	90°	1526822-1	1526822-2								
	3/8	45°	—					1526848-2			
90°		1526849-1	1526849-2								
1/2		45°	1526854-1					1526854-2			
		90°	1526856-1					1526856-2			
4/0	.590 14.99	1.035 26.29	.525 13.34	1/2	90°	—	1526878-2				
				3/8	45°	1526896-1	1526897-2				
					45°	1526913-1	—				
				1/2	90°	1526914-1	1526914-2				
					250 MCM	.685 17.40	1.20 30.55	.605 15.37	1/2	90°	—

Heavy Duty Seamless Lugs and Splices (Continued)

Seamless Angled Ring Lugs with Sight Holes

Wire Size Range
8 AWG to 1/0

Material

Terminal Body — Copper per ASTM B-152

Plating — Tin per ASTM B-545

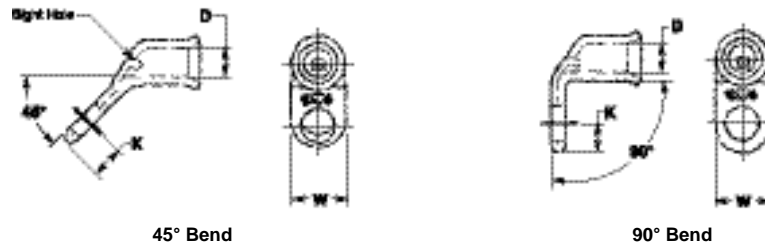

Wire Size	Dimensions			Stud Size	Angle	Part Numbers	
	D	W	K			Plain Copper	Tin Plated
8	.185	.765	.395	1/2	90°	1526159-1	1526159-2
	4.70	19.45	10.03				
6	.232	.445	.235	1/4	45°	1526170-1	1526170-2
	5.89	11.30	5.97				
4	.286	7.26	.525	1/4	90°	—	1526234-2
			13.34				
			.625	3/8	45°	1526262-1	—
			15.88				
			.765	1/2	90°	—	1526287-2
			19.45				
2	.336	8.53	.615	1/4	90°	—	1526295-2
			15.62				
			.755	5/16	45°	1526401-1	1526401-2
			19.18				
			.755	1/2	90°	1526436-1	1526436-2
			19.18				
1	.360	9.14	.655	1/4	90°	1526442-1	1526442-2
			16.64				
			.755	5/16	90°	—	1526447-2
			19.18				
			.725	3/8	90°	1526457-1	—
			18.42				
1/0	.407	10.33	.825	5/16	90°	—	1526701-2
			20.96				
			.825	3/8	45°	1526726-1	—
			20.96				
			.825	1/2	90°	1526727-1	—
			20.96				
.825	1/2	45°	1526735-1	—			
20.96					10.80		
2/0	.461	11.71	.825	1/4	90°	1526743-1	1526743-2
			20.96				
			.825	5/16	90°	1526751-1	1526751-2
			20.96				
			.825	3/8	45°	1526770-1	—
			20.96				
.825	3/8	90°	1526772-1	—			
20.96					10.80		
.825	1/2	45°	1526786-1	—			
20.96					10.80		
3/0	.511	12.98	.895	5/16	90°	1526804-1	—
			22.73				
			.895	3/8	90°	1526813-1	—
			22.73				
			.895	1/2	45°	1526824-1	—
			22.73				
.559	1/2	45°	1526857-1	—			
14.20					25.02		
4/0	.590	14.99	1.035	3/8	45°	1526868-1	—
			26.29				
			1.035	1/2	45°	1526879-1	—
			26.29				
			1.035	1/2	90°	1526880-1	—
			26.29				
.625	3/8	45°	1526899-1	1526899-2			
15.87					14.10		
.625	1/2	90°	1526901-1	1526901-2			
15.87					14.10		
250 MCM	.685	17.40	1.085	5/8	45°	1526916-1	—
			27.56				
250 MCM	.685	17.40	.593	5/8	90°	1526918-1	1526918-2
			15.08				
250 MCM	.685	17.40	.593	5/8	45°	1526945-1	1526945-2
			15.08				
250 MCM	.685	17.40	.593	5/8	90°	1526946-1	1526946-2
			15.08				

Heavy Duty Seamless Lugs and Splices (Continued)

Seamless Butt Splices

Wire Size Range
8 AWG to 4/0

Material

Terminal Body — Copper per
ASTM B-152

Plating — Tin per ASTM B-545

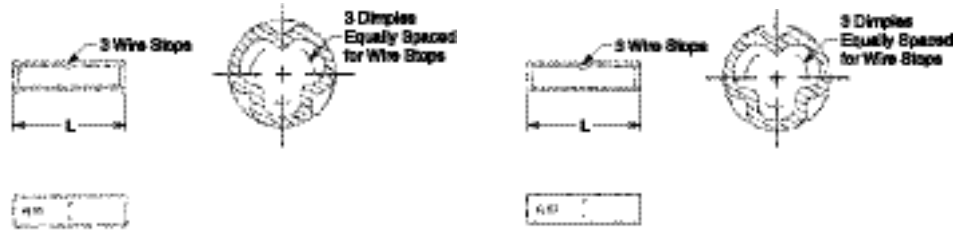

Flared Ends

Wire Size	Barrel I.D.	Dim. L Max.	Part Number Tin Plated
8	.170 4.32	.990 25.15	1526961-2
6	.232 5.89	1.090 27.69	1526962-2
4	.286 7.26	1.230 31.24	1526963-2
2	.336 8.53	1.380 35.05	1526965-2
1	.360 9.14	1.380 35.05	1526966-2
1/0	.407 10.33	1.580 40.13	1526967-2
2/0	.461 11.71	1.830 46.48	1526968-2
3/0	.511 12.98	1.930 49.02	1526969-2
4/0	.559 14.20	2.030 51.56	1526970-2
	.590 14.99	2.030 51.56	1526971-2
	.625 15.88	2.030 51.56	1526972-2

Chamfered Ends

Wire Size	Barrel I.D.	Dim. L Max.	Part Number Tin Plated
8	.170 4.32	.990 25.15	1526979-2
6	.232 5.89	1.090 27.69	1526980-2
4	.286 7.26	1.230 31.24	1526981-2
2	.336 8.53	1.380 35.05	1526982-2
1	.360 9.14	1.380 35.05	1526983-2
1/0	.407 10.33	1.580 40.13	1526984-2
2/0	.461 11.71	1.830 46.48	1526985-2
4/0	.559 14.20	2.030 51.56	1526987-2
	.625 15.88	2.030 51.56	1526989-2

Industrial Electrical Lugs and Splices

Industrial Lugs
ETP Copper, Color Coded,
Tin-Plated, Sight Hole,
Flared Ends
Wire Size Range
8 AWG to 4/0

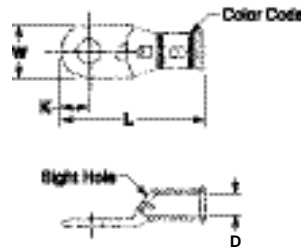

Material

Terminal Body — Copper per ASTM B-152

Plating — Tin per ASTM B-545

AWG	Color Code	Dimensions				Stud Size	Part Number	
		D	L	W	K			
8	Red	.186	1.200	.445	.235	10	1527115-3	
		4.72	30.48	11.30	5.97	1/4	1527117-3	
		.186	1.305	.605	.315	1/4	1527119-3	
		4.72	33.15	15.37	8.00	5/16	1527120-3	
		.186	1.480	.765	.395	3/8	1527121-3	
		4.72	37.59	19.43	10.03	3/8	1527122-3	
	6	Blue	.232	1.270	.445	.235	1/2	1527123-3
			5.89	32.26	11.30	5.97	10	1527124-3
			.232	1.410	.605	.315	1/4	1527125-3
			5.89	35.81	15.37	8.00	1/4	1527126-3
			.232	1.550	.765	.395	5/16	1527127-3
			5.89	39.37	19.43	10.03	3/8	1527128-3
4	Grey	.286	1.500	.525	.275	3/8	1527129-3	
		7.26	38.10	13.34	6.99	1/2	1527130-3	
		.286	1.530	.625	.325	10	1527131-3	
		7.26	38.86	15.88	8.26	1/4	1527132-3	
		.286	1.680	.765	.395	5/16	1527133-3	
		7.26	42.67	19.43	10.03	3/8	1527134-3	
2	Brown	.336	1.620	.615	.325	3/8	1527135-3	
		8.53	41.15	15.62	8.26	1/2	1527136-3	
		.336	1.750	.755	.395	10	1527137-3	
		8.53	44.45	19.18	10.03	1/4	1527138-3	
		.336	1.830	.825	.425	5/16	1527139-3	
		8.53	46.48	20.96	10.80	3/8	1527140-3	
1	Green	.407	1.830	.725	.385	3/8	1527141-3	
		10.34	46.48	18.42	9.78	1/2	1527142-3	
		.407	1.900	.825	.425	10	1527143-3	
		10.34	48.26	20.96	10.80	1/4	1527144-3	
		.407	2.060	.815	.425	5/16	1527096-3	
		10.34	52.32	20.70	10.80	3/8	1527096-3	
1/0	Pink	.461	2.160	.895	.465	3/8	1527146-3	
		11.71	54.86	22.73	11.81	1/2	1527147-3	
		.511	2.160	.895	.465	10	1527148-3	
		12.98	54.86	22.73	11.81	1/4	1527149-3	
		.511	2.350	.985	.505	5/16	1527150-3	
		12.98	59.69	25.02	12.83	3/8	1527151-3	
2/0	Black	.559	2.350	.985	.505	1/2	1527152-3	
		14.20	59.69	25.02	12.83	10	1527153-3	
		.559	2.500	1.125	.545	5/16	1527154-3	
		14.20	63.50	28.58	13.93	3/8	1527155-3	
		.559	2.650	1.265	.585	1/2	1527156-3	
		14.20	67.31	32.13	14.93	1/4	1527157-3	
3/0	Orange	.559	2.650	1.265	.585	5/16	1527158-3	
		14.20	67.31	32.13	14.93	3/8	1527159-3	
		.559	2.800	1.405	.625	10	1527160-3	
		14.20	71.12	35.68	15.93	1/4	1527161-3	
		.559	2.950	1.545	.665	5/16	1527162-3	
		14.20	74.93	39.23	16.93	3/8	1527163-3	
4/0	Purple	.559	2.950	1.545	.665	1/2	1527164-3	
		14.20	74.93	39.23	16.93	10	1527165-3	
		.559	3.100	1.685	.705	5/16	1527166-3	
		14.20	78.74	42.78	17.93	3/8	1527167-3	
		.559	3.250	1.825	.745	1/2	1527168-3	
		14.20	82.55	46.33	18.93	1/4	1527169-3	

Industrial Electrical Lugs and Splices (Continued)

Industrial Butt Splices

Wire Size Range
8 AWG to 4/0

Material

Terminal Body — Copper per
ASTM B-75

Plating — Tin per ASTM B-545

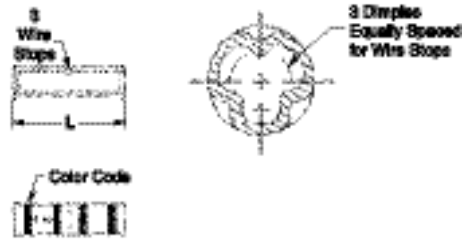

AWG	Color Code	Barrel I.D.	Dim. L Max.	Part Number
8	Red	.170 4.32	.990 25.15	1526990-3
6	Blue	.232 5.89	1.090 27.69	1526991-3
4	Grey	.286 7.26	1.230 31.24	1526992-3
2	Brown	.336 9.14	1.380 35.05	1526993-3
1	Green	.360 9.14	1.380 35.05	1526994-3
1/0	Pink	.407 10.34	1.580 40.13	1526995-3
2/0	Black	.461 11.71	1.830 46.48	1526996-3
3/0	Orange	.511 12.98	1.930 49.02	1526997-3
4/0	Purple	.559 14.20	2.030 51.56	1526998-3

Copper Compression Lugs and Splices

Standard Barrel Lug with One Stud Hole

Wire Size Range
8 AWG to 500 MCM

Material

Terminal Body — Copper per ASTM B-75

Plating — Tin per ASTM B-545

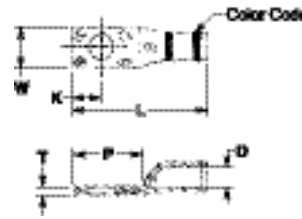

AWG	Color Code	Dimensions						Stud Size	Part Number
		D	L	W	K	P	T		
8	Red	.170	1.150	.350	.250	.595	.078	10	1527208-3
		4.32	29.21	8.89	6.35	15.11	1.98		
		.170	1.150	.460	.250	.595	.078	1/4	1527209-3
		4.32	29.21	11.68	6.35	15.11	1.98		
6	Blue	.204	1.230	.400	.250	.625	.078	10	1527210-3
		5.18	31.24	10.16	6.35	15.87	1.98	1/4	1527211-3
		.204	1.230	.530	.250	.625	.078	5/16	1527214-3
		5.18	31.24	13.46	6.35	15.87	1.98		
4	Grey	.252	1.410	.500	.300	.725	.108	10	1527215-3
		6.40	35.81	12.70	7.62	18.42	2.74	1/4	1527216-3
		.252	1.410	.640	.300	.725	.108	5/16	1527217-3
		6.40	35.81	16.26	7.62	18.42	2.74		
		.252	1.410	.500	.300	.725	.108	3/8	1527219-3
		6.40	35.81	12.70	7.62	18.42	2.74		
2	Brown	.312	1.580	.610	.350	.825	.124	1/4	1527220-3
		7.92	40.13	15.49	8.89	20.96	3.15	5/16	1527221-3
								3/8	1527222-3
								1/4	1527225-3
1	Green	.352	1.850	.690	.400	.975	.134	5/16	1527226-3
		8.94	46.99	17.52	10.16	24.77	3.40	3/8	1527227-3
								1/2	1527228-3
								1/4	1527229-3
1/0	Pink	.393	2.010	.760	.450	1.025	.140	5/16	1527230-3
		9.98	51.05	19.30	11.43	26.04	3.56	3/8	1527231-3
								1/2	1527232-3
								1/4	1527233-3
2/0	Black	.443	2.120	.830	.450	1.025	.140	5/16	1527234-3
		11.25	53.85	21.08	11.43	26.04	3.56	3/8	1527235-3
								1/2	1527237-3
								1/4	1527238-3
3/0	Orange	.490	2.250	.910	.450	1.025	.140	5/16	1527240-3
		12.44	57.15	23.11	11.43	26.04	3.56	3/8	1527242-3
								1/2	1527243-3
								1/4	1527244-3
4/0	Purple	.548	2.330	1.020	.450	1.025	.155	3/8	1527247-3
		13.92	59.18	25.91	11.43	26.04	3.96	1/2	1527249-3
250 MCM	Yellow	.600	2.610	1.140	.500	1.165	.186	3/8	1527251-3
		15.24	66.29	28.97	12.70	29.59	4.72	1/2	1527253-3
								3/8	1527255-3
								1/2	1527256-3
300 MCM	White	.660	2.800	1.220	.550	1.235	.186	5/8	1527258-3
		16.76	71.12	30.99	13.97	31.37	4.72	3/8	1527259-3
								1/2	1527260-3
								5/8	1527261-3
350 MCM	Red	.711	2.980	1.320	.550	1.275	.202	1/2	1527263-3
		18.06	75.69	33.52	13.97	32.39	5.13	3/8	1527266-3
								1/2	1527267-3
								3/8	1527268-3
400 MCM	Blue	.758	3.100	1.400	.550	1.305	.218	3/8	1527266-3
		19.25	78.74	35.56	13.97	33.15	5.54	1/2	1527263-3
								3/8	1527267-3
								1/2	1527268-3
500 MCM	Brown	.843	3.350	1.580	.550	1.325	.250	3/8	1527267-3
		21.41	85.09	40.13	13.97	33.66	6.35	1/2	1527268-3
							5/8	1527270-3	

Copper Compression Lugs and Splices (Continued)

Standard Barrel Lug with Two Stud Holes

Wire Size Range
8 AWG to 500 MCM

Material

Terminal Body — Copper per ASTM B-75

Plating — Tin per ASTM B-545

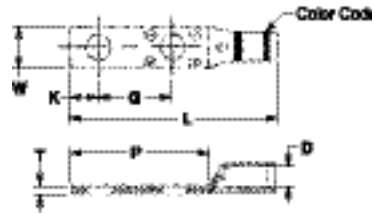

AWG	Color Code	Dimensions							Stud Size	Part Number
		D	L	W	K	P	G	T		
8	Red	.170	1.740	.350	.250	1.185	.625	.078	10	1527272-3
		4.32	44.20	8.89	6.35	30.10	15.88	1.98		
6	Blue	.204	1.900	.400	.250	1.295	.625	.078	1/4	1527273-3
		5.18	48.26	10.16	6.35	32.89	15.88	1.98		
4	Grey	.252	2.000	.500	.300	1.315	.625	.108	1/4	1527277-3
		6.40	50.80	12.70	7.62	33.40	15.88	2.74		
		.312	2.100	.610	.300	1.345	.625	.124	5/16	1527278-3
		7.92	53.34	15.49	7.62	34.16	15.88	3.15		
2	Brown	.312	2.200	.610	.300	1.465	.750	.124	1/4	1527279-3
		7.92	55.88	15.49	7.62	37.21	19.05	3.15		
1	Green	.352	2.250	.690	.300	1.375	.625	.134	1/4	1527281-3
		8.94	57.15	17.53	7.62	34.93	15.88	3.40		
1/0	Pink	.352	2.375	.690	.300	1.495	.750	.134	5/16	1527283-3
		8.94	60.33	17.53	7.62	37.97	19.05	3.40		
1/0	Pink	.393	2.680	.760	.350	1.695	.875	.140	5/16	1527284-3
		9.98	68.07	19.30	8.89	43.05	22.23	3.56		
2/0	Black	.393	2.900	.760	.400	1.915	1.000	.140	3/8	1527285-3
		9.98	73.66	19.30	10.16	48.64	25.40	3.56		
2/0	Black	.443	2.900	.830	.350	1.805	1.000	.140	5/16	1527286-3
		11.25	73.66	21.08	8.89	45.85	25.40	3.56		
2/0	Black	.443	3.800	.830	.450	2.705	1.750	.140	1/2	1527288-3
		11.25	96.52	21.08	11.43	68.71	44.45	3.56		
3/0	Orange	.490	3.200	.910	.450	1.975	1.000	.140	3/8	1527291-3
		12.45	81.28	23.11	11.43	50.17	25.40	3.56		
3/0	Orange	.490	3.950	.910	.450	2.725	1.750	.140	1/2	1527293-3
		12.45	100.33	23.11	11.43	69.22	44.45	3.56		
4/0	Purple	.548	3.330	1.020	.450	1.975	1.000	.156	3/8	1527294-3
		13.92	84.58	25.91	11.43	50.17	25.40	3.96		
4/0	Purple	.548	4.120	1.020	.450	2.765	1.750	.156	1/2	1527296-3
		13.92	104.65	25.91	11.43	70.23	44.45	3.96		
250 MCM	Yellow	.600	3.420	1.140	.450	1.975	1.000	.186	3/8	1527297-3
		15.24	86.87	28.96	11.43	50.17	25.40	4.72		
250 MCM	Yellow	.600	4.250	1.140	.500	2.805	1.750	.186	1/2	1527298-3
		15.24	107.95	28.96	12.70	71.25	44.45	4.72		
300 MCM	White	.660	3.600	1.220	.450	2.035	1.000	.186	3/8	1527300-3
		16.76	91.44	30.99	11.43	51.69	25.40	4.72		
300 MCM	White	.660	4.400	1.220	.500	2.835	1.750	.186	1/2	1527301-3
		16.76	111.76	30.99	12.70	72.01	44.45	4.72		
350 MCM	Red	.711	3.700	1.320	.450	1.995	1.000	.202	3/8	1527302-3
		18.06	93.98	33.53	11.43	50.67	25.40	5.13		
350 MCM	Red	.711	4.550	1.320	.500	2.845	1.750	.202	1/2	1527303-3
		18.06	115.57	33.53	12.70	72.26	44.45	5.13		
400 MCM	Blue	.758	3.800	1.400	.450	2.005	1.000	.218	3/8	1527304-3
		19.25	96.52	35.56	11.43	50.93	25.40	5.54		
400 MCM	Blue	.758	4.650	1.400	.500	2.855	1.750	.218	1/2	1527305-3
		19.25	118.11	35.56	12.70	72.52	44.45	5.54		
500 MCM	Brown	.843	4.050	1.580	.450	2.025	1.000	.250	3/8	1527306-3
		21.41	102.87	40.13	11.43	51.44	25.40	6.35		
500 MCM	Brown	.843	4.900	1.580	.500	2.815	1.750	.250	1/2	1527307-3
		21.41	124.46	40.13	12.70	73.03	44.45	6.35		

Copper Compression Lugs and Splices (Continued)

Long Barrel Lug with One Stud Hole

Wire Size Range
8 AWG to 500 MCM

Material

Terminal Body — Copper per ASTM B-75

Plating — Tin per ASTM B-545



AWG	Color Code	Dimensions						Stud Size	Part Number
		D	L	W	K	P	T		
8	Red	.170	1.650	.350	.250	.685	.078	10	1527309-3
		4.32	41.91	8.89	6.35	17.40	1.98		
6	Blue	.204	1.700	.400	.250	.685	.078	1/4	1527311-3
		5.18	43.18	10.16	6.35	17.39	1.98		
4	Grey	.252	1.750	.500	.300	.735	.108	1/4	1527313-3
		6.40	41.45	12.70	7.62	18.67	2.74		
2	Brown	.312	2.060	.610	.350	.825	.124	1/4	1527317-3
		7.92	52.32	15.49	8.89	20.96	3.15	5/16	1527318-3
								3/8	1527315-3
1	Green	.352	2.160	.690	.350	.845	.134	1/4	1527320-3
		8.94	54.86	17.53	8.89	21.46	3.40	5/16	1527321-3
								3/8	1527319-3
1/0	Pink	.393	2.350	.760	.400	.965	.140	5/16	1527322-3
		9.98	59.69	19.30	10.16	24.51	3.56	3/8	1527324-3
								1/2	1527323-3
2/0	Black	.443	2.500	.830	.450	1.105	.140	5/16	1527589-3
		11.25	63.50	21.08	11.43	28.07	3.56	3/8	1527325-3
								1/2	1527326-3
3/0	Orange	.490	2.700	.910	.450	1.175	.140	5/16	1527590-3
		12.45	68.58	23.11	11.43	29.85	3.56	3/8	1527327-3
								1/2	1527328-3
4/0	Purple	.548	3.050	1.020	.500	1.225	.156	5/16	1527593-3
		13.92	77.47	25.91	12.70	31.12	3.97	3/8	1527329-3
								1/2	1527330-3
250 MCM	Yellow	.600	3.350	1.140	.500	1.275	.186	3/8	1527331-3
		15.24	85.09	28.96	12.70	32.39	4.72	1/2	1527332-3
300 MCM	White	.660	3.500	1.220	.500	1.285	.186	3/8	1527334-3
		17.64	88.90	30.98	12.70	32.64	4.72	1/2	1527335-3
350 MCM	Red	.711	3.700	1.320	.560	1.335	.202	3/8	1527336-3
		18.05	93.98	33.53	14.22	33.90	5.13	1/2	1527337-3
400 MCM	Blue	.758	3.900	1.400	.560	1.445	.218	1/2	1527340-3
		19.25	99.06	35.56	14.22	36.70	5.54		
500 MCM	Brown	.843	4.500	1.580	.560	1.465	.250	3/8	1527341-3
		21.41	114.30	40.13	14.22	37.21	6.35	1/2	1527343-3

Copper Compression Lugs and Splices (Continued)

Long Barrel Lug with Two Stud Holes

Wire Size Range
8 AWG to 500 MCM

Material

Terminal Body — Copper per ASTM B-75

Plating — Tin per ASTM B-545

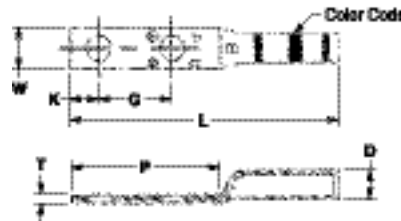

AWG	Color Code	Dimensions							Stud Size	Part Number
		D	L	W	K	P	G	T		
8	Red	.170	2.250	.350	.250	1.266	.625	.078	10	1527344-3
		4.32	57.15	8.89	6.35	32.15	15.88	1.98		
6	Blue	.204	2.300	.400	.250	1.315	.625	.078	1/4	1527347-3
		5.18	58.42	10.16	6.35	33.40	15.88	1.98		
4	Grey	.252	2.350	.500	.300	1.335	.625	.108	1/4	1527351-3
		6.40	59.69	12.70	7.62	33.91	15.88	2.74		
2	Brown	.312	2.800	.610	.350	1.565	.750	.124	1/4	1527353-3
		7.93	71.12	15.49	8.89	39.75	19.05	3.15	5/16	1527355-3
1	Green	.352	3.100	.690	.350	1.765	.750	.134	1/4	—
		8.94	78.74	17.53	8.89	44.83	19.05	3.40	5/16	1527357-3
1/0	Pink	.393	3.200	.760	.400	1.825	.750	.140	5/16	1527358-3
		9.98	81.28	19.30	10.16	46.36	19.05	3.56	3/8	1527359-3
2/0	Black	.443	4.510	.830	.620	3.095	1.750	.140	3/8	1527360-3
		11.25	114.55	21.08	15.75	78.61	44.45	3.56	1/2	1527361-3
3/0	Orange	.490	4.650	.910	.620	3.125	1.750	.140	3/8	1527362-3
		12.45	118.11	23.11	15.75	79.38	44.45	3.56	1/2	1527363-3
4/0	Purple	.548	4.950	1.020	.620	3.125	1.750	.156	3/8	1527364-3
		13.92	125.73	25.91	15.75	79.38	44.45	3.96	1/2	1527365-3
250 MCM	Yellow	.600	5.200	1.140	.620	3.125	1.750	.186	3/8	1527366-3
		15.24	132.08	28.96	15.75	79.38	44.45	4.72	1/2	1527367-3
300 MCM	White	.660	5.350	1.220	.620	3.135	1.750	.186	3/8	1527369-3
		16.76	135.89	30.99	15.75	79.63	44.45	4.72	1/2	1527370-3
350 MCM	Red	.711	5.500	1.320	.620	3.135	1.750	.202	3/8	1527371-3
		18.06	139.70	33.53	15.75	79.63	44.45	5.13	1/2	1527373-3
400 MCM	Blue	.758	5.600	1.400	.620	3.145	1.750	.218	3/8	1527374-3
		19.25	142.24	35.56	15.75	79.88	44.45	5.54	1/2	1527375-3
500 MCM	Brown	.843	6.200	1.580	.620	3.165	1.750	.250	3/8	1527377-3
		21.41	157.48	63.33	15.75	80.39	44.45	6.35	1/2	1527378-3

Copper Compression Lugs and Splices (Continued)

Standard Barrel Butt Splices, Color Coded

**Wire Size Range
8 AWG to 500 MCM**

Material

Terminal Body — Copper per ASTM B-75

Plating — Tin per ASTM B-545

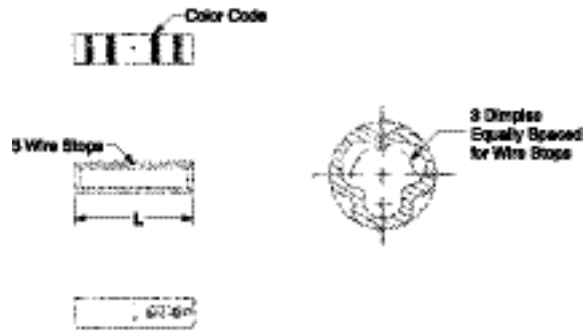

AWG	Color Code	Barrel I.D.	Dim. L	Part Number
8	Red	.170 4.32	1.000 25.40	1527379-3
6	Blue	.204 5.18	1.000 25.40	1527380-3
4	Grey	.252 6.40	1.000 25.40	1527381-3
2	Brown	.312 7.92	1.250 31.75	1527382-3
1	Green	.352 8.94	1.440 36.58	1527383-3
1/0	Pink	.393 9.98	1.440 36.58	1527384-3
2/0	Black	.443 11.25	1.560 39.62	1527385-3
3/0	Orange	.490 12.45	1.690 42.93	1527386-3
4/0	Purple	.548 13.92	1.820 46.23	1527387-3
250 MCM	Yellow	.600 15.24	2.190 55.63	1527388-3
300 MCM	White	.660 16.76	2.190 55.63	1527389-3
350 MCM	Red	.711 18.06	2.190 55.63	1527390-3
400 MCM	Blue	.758 19.25	2.750 69.85	1527264-3
500 MCM	Brown	.843 21.41	2.750 69.85	1527392-3

Copper Compression Lugs and Splices (Continued)

**Long Barrel Butt Splices,
Color Coded**

Wire Size Range
8 AWG to 500 MCM

Material

Terminal Body — Copper per
ASTM B-75



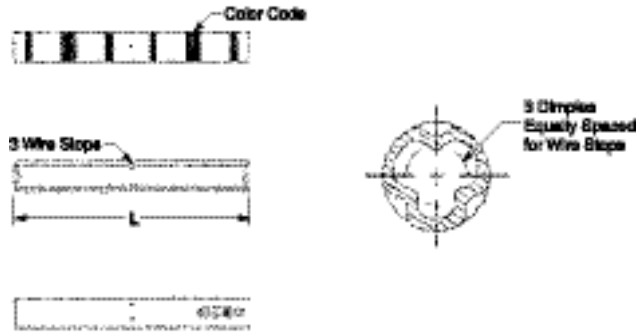







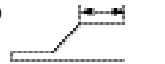
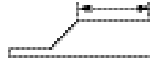

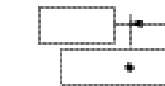
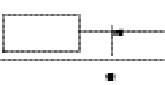

Plating — Tin per ASTM B-545







AWG	Color Code	Barrel I.D.	Dim. L	Part Number
8	Red	.170 4.32	2.000 50.80	1527393-3
6	Blue	.204 5.18	2.000 50.80	1527394-3
4	Grey	.252 6.40	2.000 50.80	1527395-3
2	Brown	.312 7.92	2.000 50.80	1527397-3
1	Green	.352 8.94	2.250 57.15	1527398-3
1/0	Pink	.393 9.98	2.250 57.15	1527399-3
2/0	Black	.443 11.25	2.380 60.45	1527400-3
3/0	Orange	.490 12.45	2.500 63.50	1527401-3
4/0	Purple	.548 13.92	3.000 76.20	1527402-3
250 MCM	Yellow	.600 15.24	3.620 91.95	1527403-3
300 MCM	White	.660 16.76	3.680 93.47	1527404-3
350 MCM	Red	.711 18.06	3.930 99.82	1527405-3
400 MCM	Blue	.758 19.25	3.930 99.82	1527406-3
500 MCM	Brown	.843 21.41	4.930 125.22	1527407-3

CUSTOMER INFORMATION: Review with Tyco Electronics Sales Engineer, Tyco Electronics Authorized Distributor, or fax to Tyco Electronics Technical Support.

Company Name _____ Your Name _____
 Address _____ City/State _____
 Telephone Number _____ Fax Number _____



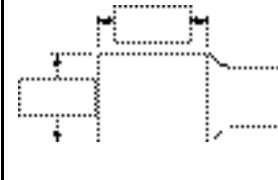

<p>Cable Specifications</p> <p>WIRE GAUGE</p> <p><input type="checkbox"/> 8 <input type="checkbox"/> 1/0 <input type="checkbox"/> 250 MCM</p> <p><input type="checkbox"/> 6 <input type="checkbox"/> 2/0 <input type="checkbox"/> 300 MCM</p> <p><input type="checkbox"/> 4 <input type="checkbox"/> 3/0 <input type="checkbox"/> 350 MCM</p> <p><input type="checkbox"/> 2 <input type="checkbox"/> 4/0 <input type="checkbox"/> 400 MCM</p> <p><input type="checkbox"/> 1 <input type="checkbox"/> 500 MCM</p> <p>TYPE</p> <p><input type="checkbox"/> STD <input type="checkbox"/> OTHER SIZE</p> <p><input type="checkbox"/> FLEX <input style="width:50px; height:20px;" type="text"/></p>	<p>Barrel Length (Lug)</p> <p><input type="checkbox"/> STANDARD </p> <p><input type="checkbox"/> LONG </p> <p><input type="checkbox"/> SPECIAL </p> <hr/> <p>Barrel Length (Splice)</p> <p><input type="checkbox"/> STD SINGLE CRIMP </p> <p><input type="checkbox"/> LONG DOUBLE CRIMP </p>	<p>PRODUCTION REQUIREMENTS</p> <p>INITIAL QTY. _____ DUE DATE _____</p> <p>1ST YEAR QTY. _____</p> <p>2ND YEAR QTY. _____ PROGRAM LIFE _____ YRS</p> <p>TARGET PRICE _____</p> <hr/> <table style="width:100%;"> <tr> <td style="width:50%;">Barrel Type</td> <td style="width:50%;">Sight Hole</td> </tr> <tr> <td><input type="checkbox"/> CHAMFERED </td> <td><input type="checkbox"/> YES </td> </tr> <tr> <td><input type="checkbox"/> FLARED </td> <td><input type="checkbox"/> NO </td> </tr> </table>	Barrel Type	Sight Hole	<input type="checkbox"/> CHAMFERED 	<input type="checkbox"/> YES 	<input type="checkbox"/> FLARED 	<input type="checkbox"/> NO 
Barrel Type	Sight Hole							
<input type="checkbox"/> CHAMFERED 	<input type="checkbox"/> YES 							
<input type="checkbox"/> FLARED 	<input type="checkbox"/> NO 							

Tongue Specifications

<input type="checkbox"/> SINGLE HOLE 	<input type="checkbox"/> DOUBLE HOLE 	<input type="checkbox"/> BLANK 	<input type="checkbox"/> NARROW 
--	--	---	---

<p>Stud Size</p> <p><input type="checkbox"/> # 8 <input type="checkbox"/> 3/8</p> <p><input type="checkbox"/> #10 <input type="checkbox"/> 1/2</p> <p><input type="checkbox"/> 1/4 <input type="checkbox"/> 3/4</p> <p><input type="checkbox"/> 5/16 <input type="checkbox"/> OTHER</p> <p><input style="width:50px; height:20px;" type="text"/></p>	<p>Special Features</p> <table style="width:100%;"> <tr> <td style="width:33%;">BARREL COLOR CODE</td> <td style="width:33%;">PLATE</td> <td style="width:33%;">AGENCY APPROVAL</td> </tr> <tr> <td><input type="checkbox"/> YES</td> <td><input type="checkbox"/> TIN</td> <td><input type="checkbox"/> UL <input type="checkbox"/> CSA</td> </tr> <tr> <td><input type="checkbox"/> NO</td> <td><input type="checkbox"/> OTHER</td> <td><input type="checkbox"/> OTHER</td> </tr> <tr> <td></td> <td>_____</td> <td>_____</td> </tr> </table>	BARREL COLOR CODE	PLATE	AGENCY APPROVAL	<input type="checkbox"/> YES	<input type="checkbox"/> TIN	<input type="checkbox"/> UL <input type="checkbox"/> CSA	<input type="checkbox"/> NO	<input type="checkbox"/> OTHER	<input type="checkbox"/> OTHER		_____	_____
BARREL COLOR CODE	PLATE	AGENCY APPROVAL											
<input type="checkbox"/> YES	<input type="checkbox"/> TIN	<input type="checkbox"/> UL <input type="checkbox"/> CSA											
<input type="checkbox"/> NO	<input type="checkbox"/> OTHER	<input type="checkbox"/> OTHER											
	_____	_____											

Angle Specifications

<input type="checkbox"/> SINGLE HOLE	<input type="checkbox"/> DOUBLE HOLE	<input type="checkbox"/> DOUBLE HOLE
<input type="checkbox"/> 45° 	<input type="checkbox"/> OTHER 	
<input type="checkbox"/> 90° 		

Fax or Mail to:
 Attn: Tyco Electronics Technical Support, 2800 Fulling Mill Road, Middletown, PA 17057
 Fax Number: 717-986-7575 Phone Number: 1-800-522-6752

Route to Product Manager GPL D89

Heavy Duty Starter/Battery Lugs and Splices

Super Lugs

Wire Size Range 4 AWG to 4/0 AWG

Heavier wall thickness and wider pads for greater heat sink capabilities. Longer barrels for double crimping when necessary. Color coded barrel.

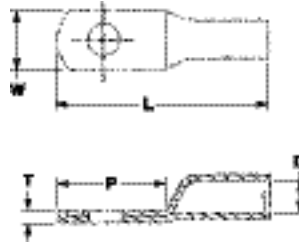

Material

Terminal Body — Copper per ASTM B-75

Plating — Tin per ASTM B-545

AWG	Optional Color Code	Dimensions					Stud Size	Part Number		
		D	L	W	P	T		Tin Plated	Tin & Color Coded	
4	Grey	.270	1.800	.525	.925	.108	1/4	1526000-2	1526003-3	
		6.86	45.72	13.34	23.50	2.74	5/16	1526005-2	1526006-3	
		.270	1.800	.640	.925	.108	3/8	1526007-2	1526012-3	
2	Green	6.86	45.72	16.26	23.50	2.74	1/4	1526013-2	1526014-3	
		.352	2.100	.690	1.025	.134	5/16	1526015-2	1526016-3	
		8.94	53.34	17.53	26.04	3.40	3/8	1526017-2	1526022-3	
1	Pink	1/4	1526023-2	1526025-3	5/16	1526026-2	1526027-3	3/8	1526028-2	1526033-3
		.393	2.150	.780	1.025	.160	1/2	1526034-2	1526039-3	
		9.98	54.61	19.81	26.04	4.06	3/8	1526041-2	1526046-3	
1/0	Black	.443	2.200	.850	1.025	.160	1/2	1526047-2	1526052-3	
		11.25	55.88	21.59	26.04	4.06	3/8	1526055-2	1526060-3	
2/0	Orange	.490	2.250	.950	1.025	.180	1/2	1526061-2	1526066-3	
		12.45	57.15	24.13	26.04	4.57	3/8	1526070-2	1526075-3	
3/0	Purple	.548	2.500	1.040	1.025	.180	1/2	1526076-2	1526081-3	
		13.92	63.50	26.42	26.04	4.57	3/8	1526083-2	1526088-3	
4/0	Yellow	.600	2.650	1.140	1.125	.186	1/2	1526089-2	1526094-3	
		15.24	67.31	28.96	28.58	4.72				

Super Butt Splices

Wire Size Range 4 AWG to 4/0 AWG

Material

Terminal Body — Copper per ASTM B-75

Plating — Tin per ASTM B-545

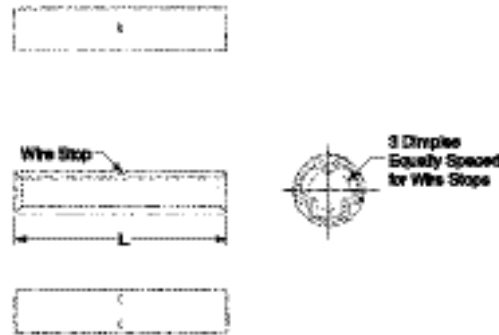

AWG	Barrel I.D.	Dim. L	Wall	Part Number	
				Tin Plated	Tin & Color Coded
4	.252	1.800	.054	1526095-2	1526096-3
	6.40	45.72	1.37		
2	.352	2.100	.067	1526097-2	1526098-3
	8.94	53.34	1.70		
1	.393	2.150	.080	1526099-2	1526100-3
	9.98	54.61	2.03		
1/0	.443	2.200	.080	1526101-2	1526102-3
	11.25	55.88	2.03		
2/0	.490	2.250	.090	1526103-2	1526104-3
	12.45	57.15	2.29		
3/0	.548	2.500	.090	1526105-2	1526106-3
	13.92	63.50	2.29		
4/0	.600	2.650	.093	1526107-2	1526108-3
	15.24	67.31	2.36		

Crimp Tooling

Hand Tool

- Crimps seamless and copper compression lugs from 6 AWG through 4/0
- Unique and simple die-insert design reduces cost, size, and weight
- Compound lever design for easy crimping
- Length: 17.75 [450.85]
- Weight: 63 ounces



Hand Tool Part Number — 1526955-1
Instruction Sheet — 408-8540

Cable Size	Die Part Number
4 and 6 AWG	1527508-1
1 and 2 AWG	1527505-1
2/0 and 1/0	1527507-1

AMP to Former AET Part Number Cross Reference

AMP Part No.	AET Part No.	AMP Part No.	AET Part No.	AMP Part No.	AET Part No.	AMP Part No.	AET Part No.
1526000-2	4149	1526118-2	8141-09-90	1526194-1	6382-02	1526291-1	2141-02
1526003-3	4149-CC	1526122-1	8561-00	1526194-2	6382-03	1526291-2	2141-03
1526005-2	4569	1526122-2	8561-01	1526196-1	6382-08-90	1526293-1	2141-08-90
1526006-3	4569-CC	1526123-1	8561-02	1526196-2	6382-09-90	1526293-2	2141-09-90
1526007-2	4389	1526123-2	8561-03	1526209-1	6383-00	1526295-2	2141-11-90
1526012-3	4389-CC	1526128-1	8142-00	1526209-2	6383-01	1526397-1	2561-00
1526013-2	2149	1526128-2	8142-01	1526210-1	6383-02	1526397-2	2561-01
1526014-3	2149-CC	1526129-1	8142-02	1526210-2	6383-03	1526398-1	2561-02
1526015-2	2569	1526134-1	8562-00	1526217-1	6503-00	1526398-2	2561-03
1526016-3	2569-CC	1526134-2	8562-01	1526217-2	6503-01	1526399-1	2561-08-45
1526017-2	2389	1526135-1	8562-02	1526218-1	6503-02	1526400-1	2561-08-90
1526022-3	2389-CC	1526135-2	8562-03	1526218-2	6503-03	1526400-2	2561-09-90
1526023-2	1149	1526142-1	8382-00	1526220-1	6503-08-90	1526401-1	2561-10-45
1526025-3	1149-CC	1526142-2	8382-01	1526220-2	6503-09-90	1526401-2	2561-11-45
1526026-2	1569	1526143-1	8382-02	1526223-1	4101-00	1526402-1	2561-10-90
1526027-3	1569-CC	1526143-2	8382-03	1526223-2	4101-01	1526402-2	2561-11-90
1526028-2	1389	1526148-1	8383-00	1526224-1	4101-02	1526405-1	2381-00
1526033-3	1389-CC	1526148-2	8383-01	1526224-2	4101-03	1526405-2	2381-01
1526034-2	1509	1526149-1	8383-02	1526229-1	4141-00	1526406-2	2381-03
1526039-3	1509-CC	1526154-1	8503-00	1526229-2	4141-01	1526408-1	2381-08-90
1526041-2	10389	1526154-2	8503-01	1526230-1	4141-02	1526415-1	2383-00
1526046-3	10389-CC	1526155-1	8503-02	1526230-2	4141-03	1526415-2	2383-01
1526047-2	10509	1526155-2	8503-03	1526232-1	4141-08-90	1526416-1	2383-02
1526052-3	10509-CC	1526157-1	8503-08-90	1526232-2	4141-09-90	1526416-2	2383-03
1526055-2	20389	1526157-2	8503-09-90	1526234-2	4141-11-90	1526423-1	2383-10-45
1526060-3	20389-CC	1526159-1	8503-10-90	1526235-1	4561-00	1526431-1	2503-00
1526061-2	20509	1526159-2	8503-11-90	1526235-2	4561-01	1526431-2	2503-01
1526066-3	20509-CC	1526160-1	6101-00	1526236-1	4561-02	1526432-1	2503-02
1526070-2	30389	1526160-2	6101-01	1526236-2	4561-03	1526432-2	2503-03
1526075-3	30389-CC	1526161-1	6101-02	1526237-1	4561-08-45	1526434-1	2503-08-90
1526076-2	30509	1526161-2	6101-03	1526237-2	4561-09-45	1526434-2	2503-09-90
1526081-3	30509-CC	1526163-1	6101-08-90	1526240-1	4561-10-90	1526436-1	2503-10-90
1526083-2	40389	1526163-2	6101-09-90	1526242-1	4381-00	1526436-2	2503-11-90
1526088-3	40389-CC	1526166-1	6141-00	1526242-2	4381-01	1526437-1	1141-00
1526089-2	40509	1526166-2	6141-01	1526243-2	4381-03	1526437-2	1141-01
1526094-3	40509-CC	1526167-1	6141-02	1526245-1	4381-08-90	1526438-2	1141-03
1526095-2	4009	1526167-2	6141-03	1526251-1	4562-00	1526442-1	1141-10-90
1526096-3	4009-CC	1526168-1	6141-08-45	1526251-2	4562-01	1526442-2	1141-11-90
1526097-2	2009	1526168-2	6141-09-45	1526252-1	4562-02	1526443-1	1561-02
1526098-3	2009-CC	1526169-1	6141-08-90	1526252-2	4562-03	1526443-2	1561-03
1526099-2	1009	1526169-2	6141-09-90	1526253-1	4562-08-45	1526445-2	1561-09-90
1526100-3	1009-CC	1526170-1	6141-10-45	1526258-1	4382-00	1526447-2	1561-11-90
1526102-3	10009-CC	1526170-2	6141-11-45	1526258-2	4382-01	1526452-1	1381-00
1526103-2	20009	1526171-1	6141-10-90	1526259-1	4382-02	1526452-2	1381-01
1526104-3	20009-CC	1526171-2	6141-11-90	1526259-2	4382-03	1526453-1	1381-02
1526106-3	30009-CC	1526173-1	6561-00	1526262-1	4382-10-45	1526453-2	1381-03
1526107-2	40009	1526173-2	6561-01	1526267-1	4383-00	1526454-2	1381-09-45
1526108-3	40009-CC	1526174-1	6561-02	1526267-2	4383-01	1526455-1	1381-08-90
1526109-1	8101-00	1526174-2	6561-03	1526268-1	4383-02	1526455-2	1381-09-90
1526109-2	8101-01	1526181-1	6142-00	1526268-2	4383-03	1526457-1	1381-10-90
1526110-1	8101-02	1526181-2	6142-01	1526272-2	4383-09-45	1526459-1	1501-00
1526110-2	8101-03	1526182-1	6142-02	1526273-2	4383-09-90	1526459-2	1501-01
1526111-1	8101-08-45	1526182-2	6142-03	1526282-1	4503-00	1526465-1	1383-00
1526111-2	8101-09-45	1526187-1	6562-00	1526282-2	4503-01	1526465-2	1383-01
1526115-1	8141-00	1526187-2	6562-01	1526283-1	4503-02	1526466-1	1383-02
1526115-2	8141-01	1526188-1	6562-02	1526283-2	4503-03	1526466-2	1383-03
1526116-1	8141-02	1526188-2	6562-03	1526284-2	4503-09-45	1526479-1	1503-00
1526116-2	8141-03	1526190-1	6562-08-90	1526285-2	4503-09-90	1526479-2	1503-01
1526117-1	8141-08-45	1526190-2	6562-09-90	1526287-2	4503-11-90	1526480-1	1503-02
1526117-2	8141-09-45	1526193-1	6382-00	1526290-1	2141-00	1526480-2	1503-03
1526118-1	8141-08-90	1526193-2	6382-01	1526290-2	2141-01	1526486-2	1503-09-45

Dimensions are in inches and millimeters unless otherwise specified. Values in brackets are metric equivalents.

Dimensions are shown for reference purposes only. Specifications subject to change.

Technical Support
 USA: 1-800-522-6752
 Canada: 1-905-475-6222
 Mexico: 01-800-733-8926

www.tycoelectronics.com

AMP to Former AET Part Number Cross Reference (Continued)

AMP Part No.	AET Part No.	AMP Part No.	AET Part No.	AMP Part No.	AET Part No.	AMP Part No.	AET Part No.
1526487-2	1503-09-90	1526769-2	20381-09-90	1526863-1	40382-00	1526967-2	10001
1526490-1	10141-00	1526770-1	20381-10-45	1526863-2	40382-01	1526968-2	20001
1526490-2	10141-01	1526772-1	20381-10-90	1526868-1	40382-10-45	1526969-2	30001
1526491-1	10141-02	1526781-1	20501-00	1526873-1	40502-00	1526970-2	40000
1526491-2	10141-03	1526781-2	20501-01	1526873-2	40502-01	1526971-2	40001
1526596-1	10561-00	1526782-1	20501-02	1526874-1	40502-02	1526972-2	40002
1526596-2	10561-01	1526782-2	20501-03	1526874-2	40502-03	1526979-2	8001-20
1526597-1	10561-02	1526783-1	20501-08-45	1526878-2	40502-09-90	1526980-2	6001-20
1526597-2	10561-03	1526783-2	20501-09-45	1526879-1	40502-10-45	1526981-2	4001-20
1526698-2	10561-09-45	1526784-1	20501-08-90	1526880-1	40502-10-90	1526982-2	2001-20
1526699-1	10561-08-90	1526784-2	20501-09-90	1526883-1	40582-00	1526983-2	1001-20
1526699-2	10561-09-90	1526786-1	20501-10-45	1526883-2	40582-01	1526984-2	10001-20
1526701-2	10561-11-90	1526788-1	20501-10-90	1526884-1	40582-02	1526985-2	20001-20
1526704-1	10381-00	1526793-1	30141-00	1526884-2	40582-03	1526987-2	40000-20
1526704-2	10381-01	1526793-2	30141-01	1526892-1	40383-00	1526989-2	40002-20
1526705-1	10381-02	1526794-2	30141-03	1526892-2	40383-01	1526990-3	8001-25
1526705-2	10381-03	1526796-2	30141-09-90	1526893-1	40383-02	1526991-3	6001-25
1526706-1	10381-08-45	1526799-1	30561-00	1526893-2	40383-03	1526992-3	4001-25
1526706-2	10381-09-45	1526799-2	30561-01	1526896-1	40383-08-45	1526993-3	2001-25
1526707-1	10381-08-90	1526800-1	30561-02	1526897-2	40383-09-90	1526994-3	1001-25
1526707-2	10381-09-90	1526800-2	30561-03	1526899-1	40383-10-45	1526995-3	10001-25
1526708-1	10381-10-45	1526804-1	30561-10-90	1526899-2	40383-11-45	1526996-3	20001-25
1526713-1	10501-00	1526805-1	30381-00	1526901-1	40383-10-90	1526997-3	30001-25
1526713-2	10501-01	1526805-2	30381-01	1526901-2	40383-11-90	1526998-3	40000-25
1526714-1	10501-02	1526806-1	30381-02	1526911-1	40503-00	1527096-3	1561-60
1526714-2	10501-03	1526806-2	30381-03	1526911-2	40503-01	1527115-3	8101-60
1526715-2	10501-09-45	1526809-1	30381-08-45	1526912-1	40503-02	1527117-3	8141-60
1526716-1	10501-08-90	1526810-1	30381-08-90	1526912-2	40503-03	1527119-3	8142-60
1526716-2	10501-09-90	1526810-2	30381-09-90	1526913-1	40503-08-45	1527120-3	8562-60
1526719-1	10383-00	1526813-1	30381-10-90	1526914-1	40503-08-90	1527121-3	8382-60
1526719-2	10383-01	1526819-1	30501-00	1526914-2	40503-09-90	1527122-3	8383-60
1526720-1	10383-02	1526819-2	30501-01	1526916-1	40503-10-45	1527123-3	8503-60
1526720-2	10383-03	1526820-1	30501-02	1526918-1	40503-10-90	1527124-3	6101-60
1526726-1	10383-10-45	1526820-2	30501-03	1526918-2	40503-11-90	1527125-3	6141-60
1526727-1	10383-10-90	1526822-1	30501-08-90	1526922-1	40583-00	1527126-3	6142-60
1526731-1	10503-00	1526822-2	30501-09-90	1526922-2	40583-01	1527127-3	6562-60
1526731-2	10503-01	1526824-1	30501-10-45	1526923-1	40583-02	1527128-3	6382-60
1526732-1	10503-02	1526830-1	40141-00	1526923-2	40583-03	1527129-3	6383-60
1526732-2	10503-03	1526830-2	40141-01	1526928-1	250381-00	1527130-3	6503-60
1526735-1	10503-10-45	1526831-1	40141-02	1526928-2	250381-01	1527131-3	4101-60
1526736-1	10503-10-90	1526831-2	40141-03	1526929-1	250381-02	1527132-3	4141-60
1526738-1	20141-00	1526837-1	40561-00	1526929-2	250381-03	1527135-3	4562-60
1526738-2	20141-01	1526837-2	40561-01	1526934-1	250501-00	1527136-3	4382-60
1526739-1	20141-02	1526838-2	40561-03	1526934-2	250501-01	1527137-3	4383-60
1526739-2	20141-03	1526844-1	40381-00	1526937-2	250501-09-90	1527138-3	4503-60
1526743-1	20141-10-90	1526844-2	40381-01	1526941-1	250581-00	1527139-3	2141-60
1526743-2	20141-11-90	1526845-2	40381-03	1526941-2	250581-01	1527140-3	2561-60
1526745-1	20561-00	1526848-2	40381-09-45	1526943-1	250581-08-45	1527141-3	2381-60
1526745-2	20561-01	1526849-1	40381-08-90	1526943-2	250581-09-45	1527142-3	2383-60
1526746-1	20561-02	1526849-2	40381-09-90	1526944-1	250581-08-90	1527143-3	2503-60
1526746-2	20561-03	1526852-1	40501-00	1526944-2	250581-09-90	1527144-3	1141-60
1526747-2	20561-09-45	1526852-2	40501-01	1526945-1	250581-10-45	1527146-3	1381-60
1526751-1	20561-10-90	1526853-1	40501-02	1526945-2	250581-11-45	1527147-3	1383-60
1526751-2	20561-11-90	1526853-2	40501-03	1526946-1	250581-10-90	1527148-3	1503-60
1526758-1	20381-00	1526854-1	40501-08-45	1526946-2	250581-11-90	1527149-3	10141-60
1526758-2	20381-01	1526854-2	40501-09-45	1526950-2	A-4180	1527150-3	10561-60
1526759-1	20381-02	1526856-1	40501-08-90	1526961-2	8001	1527151-3	10381-60
1526759-2	20381-03	1526856-2	40501-09-90	1526962-2	6001	1527152-3	10501-60
1526764-1	20381-08-45	1526857-1	40501-10-45	1526963-2	4001	1527153-3	10383-60
1526764-2	20381-09-45	1526862-1	40382-02	1526965-2	2001	1527153-3	10503-60
1526769-1	20381-08-90	1526862-2	40382-03	1526966-2	1001	1527155-3	20141-60

AMP to Former AET Part Number Cross Reference (Continued)

AMP Part No.	AET Part No.	AMP Part No.	AET Part No.	AMP Part No.	AET Part No.	AMP Part No.	AET Part No.
1527156-3	20561-60	1527256-3	300507	1527320-3	L-1147	1527380-3	6007
1527157-3	20381-60	1527258-3	300587	1527321-3	L-1567	1527381-3	4007
1527158-3	20501-60	1527259-3	350387	1527322-3	L-10567	1527382-3	2007
1527159-3	30141-60	1527260-3	350507	1527323-3	L-10507	1527383-3	1007
1527160-3	30561-60	1527261-3	350587	1527324-3	L-10387	1527384-3	10007
1527161-1	30381-60	1527263-3	400507	1527325-3	L-20387	1527385-3	20007
1527162-3	30501-60	1527264-3	400007	1527326-3	L-20507	1527386-3	30007
1527163-3	40141-60	1527266-3	400387	1527327-3	L-30387	1527387-3	40007
1527164-3	40561-60	1527267-3	500387	1527328-3	L-30507	1527388-3	250007
1527165-3	40381-60	1527268-3	500507	1527329-3	L-40387	1527389-3	300007
1527166-3	40501-60	1527270-3	500587	1527330-3	L-40507	1527390-3	350007
1527208-3	8107	1527272-3	2-8107	1527331-3	L-250387	1527392-3	500007
1527209-3	8147	1527273-3	2-6147	1527332-3	L-250507	1527393-3	L-8007
1527210-3	6107	1527277-3	2-4147	1527334-3	L-300387	1527394-3	L-6007
1527211-3	6147	1527278-3	2-4567	1527335-3	L-300507	1527395-3	L-4007
1527214-3	6567	1527279-3	2-2147	1527336-3	L-350387	1527397-3	L-2007
1527215-3	4107	1527280-3	2-2567	1527337-3	L-350507	1527398-3	L-1007
1527216-3	4147	1527281-3	2-1147	1527340-3	L-400507	1527399-3	L-10007
1527217-3	4387	1527283-3	2-1567	1527341-3	L-500387	1527400-3	L-20007
1527219-3	4567	1527284-3	2-10567	1527343-3	L-500507	1527401-3	L-30007
1527220-3	2147	1527285-3	2-10387	1527344-3	L2-8107	1527402-3	L-40007
1527221-3	2567	1527286-3	2-20567	1527347-3	L2-6147	1527403-3	L-250007
1527222-3	2387	1527287-3	2-20387	1527351-3	L2-4147	1527404-3	L-300007
1527225-3	1147	1527288-3	2-20507	1527353-3	L2-2147	1527405-3	L-350007
1527226-3	1567	1527291-3	2-30387	1527355-3	L2-2567	1527406-3	L-400007
1527227-3	1387	1527293-3	2-30507	1527357-3	L2-1567	1527407-3	L-500007
1527228-3	1507	1527294-3	2-40387	1527358-3	L2-10567	1527589-3	L-20567
1527229-3	10147	1527296-3	2-40507	1527359-3	L2-10387	1527590-3	L-30567
1527230-3	10567	1527297-3	2-250387	1527360-3	L2-20387	1527593-3	L-40567
1527231-3	10387	1527298-3	2-250507	1527361-3	L2-20507		
1527232-3	10507	1527300-3	2-300387	1527362-3	L2-30387		
1527233-3	20147	1527301-3	2-300507	1527363-3	L2-30507		
1527234-3	20567	1527302-3	2-350387	1527364-3	L2-40387		
1527235-3	20387	1527303-3	2-350507	1527365-3	L2-40507		
1527237-3	20507	1527304-3	2-400387	1527366-3	L2-250387		
1527238-3	30147	1527305-3	2-400507	1527367-3	L2-250507		
1527240-3	30567	1527306-3	2-500387	1527369-3	L2-300387		
1527242-3	30387	1527307-3	2-500507	1527370-3	L2-300507		
1527243-3	30507	1527309-3	L-8107	1527371-3	L2-350387		
1527244-3	40147	1527311-3	L-6147	1527373-3	L2-350507		
1527247-3	40387	1527313-3	L-4147	1527374-3	L2-400387		
1527249-3	40507	1527315-3	L-2387	1527375-3	L2-400507		
1527251-3	250387	1527317-3	L-2147	1527377-3	L2-500387		
1527253-3	250507	1527318-3	L-2567	1527378-3	L2-500507		
1527255-3	300387	1527319-3	L-1387	1527379-3	8007		

AMP to Former AET Tooling Part Number Cross Reference

AMP Part No.	AET Part No.
1526955-1	T-406
1527505-1	5989
1527507-1	5991
1527508-1	5992

Former AET to AMP Part Number Cross Reference

AET Part No.	AMP Part No.	AET Part No.	AMP Part No.	AET Part No.	AMP Part No.	AET Part No.	AMP Part No.
1001	1526966-2	30507	1527243-3	10383-03	1526720-2	1509-CC	1526039-3
1007	1527383-3	30509	1526076-2	10383-10-45	1526726-1	1561-02	1526443-1
1009	1526099-2	30567	1527240-3	10383-10-90	1526727-1	1561-03	1526443-2
1147	1527225-3	40000	1526970-2	10383-60	1527153-3	1561-09-90	1526445-2
1149	1526023-2	40001	1526971-2	10389-CC	1526046-3	1561-11-90	1526447-2
1387	1527227-3	40002	1526972-2	10501-00	1526713-1	1561-60	1527096-3
1389	1526028-2	40007	1527387-3	10501-01	1526713-2	1569-CC	1526027-3
1507	1527228-3	40009	1526107-2	10501-02	1526714-1	20001-20	1526985-2
1509	1526034-2	40147	1527244-3	10501-03	1526714-2	20001-25	1526996-3
1567	1527226-3	40387	1527247-3	10501-08-90	1526716-1	20009-CC	1526104-3
1569	1526026-2	40389	1526083-2	10501-09-45	1526715-2	2001-20	1526982-2
2001	1526965-2	40507	1527249-3	10501-09-90	1526716-2	2001-25	1526993-3
2007	1527382-3	40509	1526089-2	10501-60	1527152-3	2009-CC	1526098-3
2009	1526097-2	2-2147	1527279-3	10503-00	1526731-1	20141-00	1526738-1
2147	1527220-3	2-2567	1527280-3	10503-01	1526731-2	20141-01	1526738-2
2149	1526013-2	250007	1527388-3	10503-02	1526732-1	20141-02	1526739-1
2387	1527222-3	250387	1527251-3	10503-03	1526732-2	20141-03	1526739-2
2389	1526017-2	250507	1527253-3	10503-10-45	1526735-1	20141-10-90	1526743-1
2567	1527221-3	300007	1527389-3	10503-10-90	1526736-1	20141-11-90	1526743-2
2569	1526015-2	300387	1527255-3	10503-60	1527153-3	20141-60	1527155-3
4001	1526963-2	300507	1527256-3	10509-CC	1526052-3	20381-00	1526758-1
4007	1527381-3	300587	1527258-3	10561-00	1526596-1	20381-01	1526758-2
4009	1526095-2	350007	1527390-3	10561-01	1526596-2	20381-02	1526759-1
4107	1527215-3	350387	1527259-3	10561-02	1526597-1	20381-03	1526759-2
4147	1527216-3	350507	1527260-3	10561-03	1526597-2	20381-08-45	1526764-1
4149	1526000-2	350587	1527261-3	10561-08-90	1526699-1	20381-08-90	1526769-1
4387	1527217-3	400007	1527264-3	10561-09-45	1526698-2	20381-09-45	1526764-2
4389	1526007-2	400387	1527266-3	10561-09-90	1526699-2	20381-09-90	1526769-2
4567	1527219-3	400507	1527263-3	10561-11-90	1526701-2	20381-10-45	1526770-1
4569	1526005-2	500007	1527392-3	10561-60	1527150-3	20381-10-90	1526772-1
6001	1526962-2	500387	1527267-3	1141-00	1526437-1	20381-60	1527157-3
6007	1527380-3	500507	1527268-3	1141-01	1526437-2	20389-CC	1526060-3
6107	1527210-3	500587	1527270-3	1141-03	1526438-2	20501-00	1526781-1
6147	1527211-3	2-4147	1527277-3	1141-10-90	1526442-1	20501-01	1526781-2
6567	1527214-3	2-4567	1527278-3	1141-11-90	1526442-2	20501-02	1526782-1
8001	1526961-2	2-6147	1527273-3	1141-60	1527144-3	20501-03	1526782-2
8007	1527379-3	2-8107	1527272-3	1149-CC	1526025-3	20501-08-45	1526783-1
8107	1527208-3	10001-20	1526984-2	1381-00	1526452-1	20501-08-90	1526784-1
8147	1527209-3	10001-25	1526995-3	1381-01	1526452-2	20501-09-45	1526783-2
10001	1526967-2	10009-CC	1526102-3	1381-02	1526453-1	20501-09-90	1526784-2
10007	1527384-3	1001-20	1526983-2	1381-03	1526453-2	20501-10-45	1526786-1
10147	1527229-3	1001-25	1526994-3	1381-08-90	1526455-1	20501-10-90	1526788-1
10387	1527231-3	1009-CC	1526100-3	1381-09-45	1526454-2	20501-60	1527158-3
10389	1526041-2	10141-00	1526490-1	1381-09-90	1526455-2	20509-CC	1526066-3
10507	1527232-3	10141-01	1526490-2	1381-10-90	1526457-1	20561-00	1526745-1
10509	1526047-2	10141-02	1526491-1	1381-60	1527146-3	20561-01	1526745-2
10567	1527230-3	10141-03	1526491-2	1383-00	1526465-1	20561-02	1526746-1
20001	1526968-2	10141-60	1527149-3	1383-01	1526465-2	20561-03	1526746-2
20007	1527385-3	10381-00	1526704-1	1383-02	1526466-1	20561-09-45	1526747-2
20009	1526103-2	10381-01	1526704-2	1383-03	1526466-2	20561-10-90	1526751-1
20147	1527233-3	10381-02	1526705-1	1383-60	1527147-3	20561-11-90	1526751-2
20387	1527235-3	10381-03	1526705-2	1389-CC	1526033-3	20561-60	1527156-3
20389	1526055-2	10381-08-45	1526706-1	1501-00	1526459-1	2-10387	1527285-3
20507	1527237-3	10381-08-90	1526707-1	1501-01	1526459-2	2-10567	1527284-3
20509	1526061-2	10381-09-45	1526706-2	1503-00	1526479-1	2-1147	1527281-3
20567	1527234-3	10381-09-90	1526707-2	1503-01	1526479-2	2141-00	1526290-1
30001	1526969-2	10381-10-45	1526708-1	1503-02	1526480-1	2141-01	1526290-2
30007	1527386-3	10381-60	1527151-3	1503-03	1526480-2	2141-02	1526291-1
30147	1527238-3	10383-00	1526719-1	1503-09-45	1526486-2	2141-03	1526291-2
30387	1527242-3	10383-01	1526719-2	1503-09-90	1526487-2	2141-08-90	1526293-1
30389	1526070-2	10383-02	1526720-1	1503-60	1527148-3	2141-09-90	1526293-2

Former AET to AMP Part Number Cross Reference (Continued)

AET Part No.	AMP Part No.	AET Part No.	AMP Part No.	AET Part No.	AMP Part No.	AET Part No.	AMP Part No.
2141-11-90	1526295-2	2561-02	1526398-1	40381-60	1527165-3	4101-60	1527131-3
2141-60	1527139-3	2561-03	1526398-2	40382-00	1526863-1	4141-00	1526229-1
2149-CC	1526014-3	2561-08-45	1526399-1	40382-01	1526863-2	4141-01	1526229-2
2-1567	1527283-3	2561-08-90	1526400-1	40382-02	1526862-1	4141-02	1526230-1
2-20387	1527287-3	2561-09-90	1526400-2	40382-03	1526862-2	4141-03	1526230-2
2-20507	1527288-3	2561-10-45	1526401-1	40382-10-45	1526868-1	4141-08-90	1526232-1
2-20567	1527286-3	2561-10-90	1526402-1	40383-00	1526892-1	4141-09-90	1526232-2
2-250387	1527297-3	2561-11-45	1526401-2	40383-01	1526892-2	4141-11-90	1526234-2
2-250507	1527298-3	2561-11-90	1526402-2	40383-02	1526893-1	4141-60	1527132-3
2-300387	1527300-3	2561-60	1527140-3	40383-03	1526893-2	4149-CC	1526003-3
2-300507	1527301-3	2569-CC	1526016-3	40383-08-45	1526896-1	4381-00	1526242-1
2-30387	1527291-3	30001-25	1526997-3	40383-09-90	1526897-2	4381-01	1526242-2
2-30507	1527293-3	30009-CC	1526106-3	40383-10-45	1526899-1	4381-03	1526243-2
2-350387	1527302-3	30141-00	1526793-1	40383-10-90	1526901-1	4381-08-90	1526245-1
2-350507	1527303-3	30141-01	1526793-2	40383-11-45	1526899-2	4382-00	1526258-1
2381-00	1526405-1	30141-03	1526794-2	40383-11-90	1526901-2	4382-01	1526258-2
2381-01	1526405-2	30141-09-90	1526796-2	40389-CC	1526088-3	4382-02	1526259-1
2381-03	1526406-2	30141-60	1527159-3	40501-00	1526852-1	4382-03	1526259-2
2381-08-90	1526408-1	30381-00	1526805-1	40501-01	1526852-2	4382-10-45	1526262-1
2381-60	1527141-3	30381-01	1526805-2	40501-02	1526853-1	4382-60	1527136-3
2383-00	1526415-1	30381-02	1526806-1	40501-03	1526853-2	4383-00	1526267-1
2383-01	1526415-2	30381-03	1526806-2	40501-08-45	1526854-1	4383-01	1526267-2
2383-02	1526416-1	30381-08-45	1526809-1	40501-08-90	1526856-1	4383-02	1526268-1
2383-03	1526416-2	30381-08-90	1526810-1	40501-09-45	1526854-2	4383-03	1526268-2
2383-10-45	1526423-1	30381-09-90	1526810-2	40501-09-90	1526856-2	4383-09-45	1526272-2
2383-60	1527142-3	30381-10-90	1526813-1	40501-10-45	1526857-1	4383-09-90	1526273-2
2389-CC	1526022-3	30381-60	1527161-1	40501-60	1527166-3	4383-60	1527137-3
2-400387	1527304-3	30389-CC	1526075-3	40502-00	1526873-1	4389-CC	1526012-3
2-400507	1527305-3	30501-00	1526819-1	40502-01	1526873-2	4503-00	1526282-1
2-40387	1527294-3	30501-01	1526819-2	40502-02	1526874-1	4503-01	1526282-2
2-40507	1527296-3	30501-02	1526820-1	40502-03	1526874-2	4503-02	1526283-1
2-500387	1527306-3	30501-03	1526820-2	40502-09-90	1526878-2	4503-03	1526283-2
2-500507	1527307-3	30501-08-90	1526822-1	40502-10-45	1526879-1	4503-09-45	1526284-2
2503-00	1526431-1	30501-09-90	1526822-2	40502-10-90	1526880-1	4503-09-90	1526285-2
2503-01	1526431-2	30501-10-45	1526824-1	40503-00	1526911-1	4503-11-90	1526287-2
2503-02	1526432-1	30501-60	1527162-3	40503-01	1526911-2	4503-60	1527138-3
2503-03	1526432-2	30509-CC	1526081-3	40503-02	1526912-1	4561-00	1526235-1
2503-08-90	1526434-1	30561-00	1526799-1	40503-03	1526912-2	4561-01	1526235-2
2503-09-90	1526434-2	30561-01	1526799-2	40503-08-45	1526913-1	4561-02	1526236-1
2503-10-90	1526436-1	30561-02	1526800-1	40503-08-90	1526914-1	4561-03	1526236-2
2503-11-90	1526436-2	30561-03	1526800-2	40503-09-90	1526914-2	4561-08-45	1526237-1
2503-60	1527143-3	30561-10-90	1526804-1	40503-10-45	1526916-1	4561-09-45	1526237-2
250381-00	1526928-1	30561-60	1527160-3	40503-10-90	1526918-1	4561-10-90	1526240-1
250381-01	1526928-2	40000-20	1526987-2	40503-11-90	1526918-2	4562-00	1526251-1
250381-02	1526929-1	40000-25	1526998-3	40509-CC	1526094-3	4562-01	1526251-2
250381-03	1526929-2	40002-20	1526989-2	40561-00	1526837-1	4562-02	1526252-1
250501-00	1526934-1	40009-CC	1526108-3	40561-01	1526837-2	4562-03	1526252-2
250501-01	1526934-2	4001-20	1526981-2	40561-03	1526838-2	4562-08-45	1526253-1
250501-09-90	1526937-2	4001-25	1526992-3	40561-60	1527164-3	4562-60	1527135-3
250581-00	1526941-1	4009-CC	1526096-3	40582-00	1526883-1	4569-CC	1526006-3
250581-01	1526941-2	40141-00	1526830-1	40582-01	1526883-2	6001-20	1526980-2
250581-08-45	1526943-1	40141-01	1526830-2	40582-02	1526884-1	6001-25	1526991-3
250581-08-90	1526944-1	40141-02	1526831-1	40582-03	1526884-2	6101-00	1526160-1
250581-09-45	1526943-2	40141-03	1526831-2	40583-00	1526922-1	6101-01	1526160-2
250581-09-90	1526944-2	40141-60	1527163-3	40583-01	1526922-2	6101-02	1526161-1
250581-10-45	1526945-1	40381-00	1526844-1	40583-02	1526923-1	6101-03	1526161-2
250581-10-90	1526946-1	40381-01	1526844-2	40583-03	1526923-2	6101-08-90	1526163-1
250581-11-45	1526945-2	40381-03	1526845-2	4101-00	1526223-1	6101-09-90	1526163-2
250581-11-90	1526946-2	40381-08-90	1526849-1	4101-01	1526223-2	6101-60	1527124-3
2561-00	1526397-1	40381-09-45	1526848-2	4101-02	1526224-1	6141-00	1526166-1
2561-01	1526397-2	40381-09-90	1526849-2	4101-03	1526224-2	6141-01	1526166-2

Dimensions are in inches and millimeters unless otherwise specified. Values in brackets are metric equivalents.

Dimensions are shown for reference purposes only. Specifications subject to change.

Technical Support
 USA: 1-800-522-6752
 Canada: 1-905-475-6222
 Mexico: 01-800-733-8926

www.tycoelectronics.com

Former AET to AMP Part Number Cross Reference (Continued)

AET Part No.	AMP Part No.	AET Part No.	AMP Part No.	AET Part No.	AMP Part No.	AET Part No.	AMP Part No.
6141-02	1526167-1	6562-60	1527127-3	8562-00	1526134-1	L-250507	1527332-3
6141-03	1526167-2	8001-20	1526979-2	8562-01	1526134-2	L-2567	1527318-3
6141-08-45	1526168-1	8001-25	1526990-3	8562-02	1526135-1	L2-6147	1527347-3
6141-08-90	1526169-1	8101-00	1526109-1	8562-03	1526135-2	L2-8107	1527344-3
6141-09-45	1526168-2	8101-01	1526109-2	8562-60	1527120-3	L-300007	1527404-3
6141-09-90	1526169-2	8101-02	1526110-1	A-4180	1526950-2	L-30007	1527401-3
6141-10-45	1526170-1	8101-03	1526110-2	L-10007	1527399-3	L-300387	1527334-3
6141-10-90	1526171-1	8101-08-45	1526111-1	L-1007	1527398-3	L-300507	1527335-3
6141-11-45	1526170-2	8101-09-45	1526111-2	L-10387	1527324-3	L-30387	1527327-3
6141-11-90	1526171-2	8101-60	1527115-3	L-10507	1527323-3	L-30507	1527328-3
6141-60	1527125-3	8141-00	1526115-1	L-10567	1527322-3	L-30567	1527590-3
6142-00	1526181-1	8141-01	1526115-2	L-1147	1527320-3	L-350007	1527405-3
6142-01	1526181-2	8141-02	1526116-1	L-1387	1527319-3	L-350387	1527336-3
6142-02	1526182-1	8141-03	1526116-2	L-1567	1527321-3	L-350507	1527337-3
6142-03	1526182-2	8141-08-45	1526117-1	L-20007	1527400-3	L-400007	1527406-3
6142-60	1527126-3	8141-08-90	1526118-1	L-2007	1527397-3	L-40007	1527402-3
6382-00	1526193-1	8141-09-45	1526117-2	L-20387	1527325-3	L-400507	1527340-3
6382-01	1526193-2	8141-09-90	1526118-2	L-20507	1527326-3	L-4007	1527395-3
6382-02	1526194-1	8141-60	1527117-3	L-20567	1527589-3	L-40387	1527329-3
6382-03	1526194-2	8142-00	1526128-1	L2-10387	1527359-3	L-40507	1527330-3
6382-08-90	1526196-1	8142-01	1526128-2	L2-10567	1527358-3	L-40567	1527593-3
6382-09-90	1526196-2	8142-02	1526129-1	L-2147	1527317-3	L-4147	1527313-3
6382-60	1527128-3	8142-60	1527119-3	L2-1567	1527357-3	L-500007	1527407-3
6383-00	1526209-1	8382-00	1526142-1	L2-20387	1527360-3	L-500387	1527341-3
6383-01	1526209-2	8382-01	1526142-2	L2-20507	1527361-3	L-500507	1527343-3
6383-02	1526210-1	8382-02	1526143-1	L2-2147	1527353-3	L-6007	1527394-3
6383-03	1526210-2	8382-03	1526143-2	L2-250387	1527366-3	L-6147	1527311-3
6383-60	1527129-3	8382-60	1527121-3	L2-250507	1527367-3	L-8007	1527393-3
6503-00	1526217-1	8383-00	1526148-1	L2-2567	1527355-3	L-8107	1527309-3
6503-01	1526217-2	8383-01	1526148-2	L2-300387	1527369-3		
6503-02	1526218-1	8383-02	1526149-1	L2-300507	1527370-3		
6503-03	1526218-2	8383-60	1527122-3	L2-30387	1527362-3		
6503-08-90	1526220-1	8503-00	1526154-1	L2-30507	1527363-3		
6503-09-90	1526220-2	8503-01	1526154-2	L2-350387	1527371-3		
6503-60	1527130-3	8503-02	1526155-1	L2-350507	1527373-3		
6561-00	1526173-1	8503-03	1526155-2	L-2387	1527315-3		
6561-01	1526173-2	8503-08-90	1526157-1	L2-400387	1527374-3		
6561-02	1526174-1	8503-09-90	1526157-2	L2-400507	1527375-3		
6561-03	1526174-2	8503-10-90	1526159-1	L2-40387	1527364-3		
6562-00	1526187-1	8503-11-90	1526159-2	L2-40507	1527365-3		
6562-01	1526187-2	8503-60	1527123-3	L2-4147	1527351-3		
6562-02	1526188-1	8561-00	1526122-1	L-250007	1527403-3		
6562-03	1526188-2	8561-01	1526122-2	L2-500387	1527377-3		
6562-08-90	1526190-1	8561-02	1526123-1	L2-500507	1527378-3		
6562-09-90	1526190-2	8561-03	1526123-2	L-250387	1527331-3		

Former AET to AMP Tooling Part Number Cross Reference

AET Part No.	AMP Part No.
5989	1527505-1
5991	1527507-1
5992	1527508-1
T-406	1526955-1

Part Number Index

Part No.	Page	Part No.	Page	Part No.	Page	Part No.	Page
1526000-2	29	1526118-1	16	1526194-1	14	1526291-2	14
1526003-3	29	1526118-2	16	1526194-2	14	1526293-1	16
1526005-2	29	1526122-1	12	1526196-1	16	1526293-2	16
1526006-3	29	1526122-2	12	1526196-2	16	1526295-2	18
1526007-2	29	1526123-1	14	1526209-1	12	1526397-1	12
1526012-3	29	1526123-2	14	1526209-2	12	1526397-2	12
1526013-2	29	1526128-1	12	1526210-1	14	1526398-1	14
1526014-3	29	1526128-2	12	1526210-2	14	1526398-2	14
1526015-2	29	1526129-1	14	1526217-1	12	1526399-1	16
1526016-3	29	1526134-1	12	1526217-2	12	1526400-1	16
1526017-2	29	1526134-2	12	1526218-1	14	1526400-2	16
1526022-3	29	1526135-1	14	1526218-2	14	1526401-1	18
1526023-2	29	1526135-2	14	1526220-1	16	1526401-2	18
1526025-3	29	1526142-1	12	1526220-2	16	1526402-1	18
1526026-2	29	1526142-2	12	1526223-1	12	1526402-2	18
1526027-3	29	1526143-1	14	1526223-2	12	1526405-1	12
1526028-2	29	1526143-2	14	1526224-1	14	1526405-2	12
1526033-3	29	1526148-1	12	1526224-2	14	1526406-2	14
1526034-2	29	1526148-2	12	1526229-1	12	1526408-1	16
1526039-3	29	1526149-1	14	1526229-2	12	1526415-1	12
1526041-2	29	1526154-1	12	1526230-1	14	1526415-2	12
1526046-3	29	1526154-2	12	1526230-2	14	1526416-1	14
1526047-2	29	1526155-1	14	1526232-1	16	1526416-2	14
1526052-3	29	1526155-2	14	1526232-2	16	1526423-1	18
1526055-2	29	1526157-1	16	1526234-2	18	1526431-1	12
1526060-3	29	1526157-2	16	1526235-1	12	1526431-2	12
1526061-2	29	1526159-1	18	1526235-2	12	1526432-1	14
1526066-3	29	1526159-2	18	1526236-1	14	1526432-2	14
1526070-2	29	1526160-1	12	1526236-2	14	1526434-1	16
1526075-3	29	1526160-2	12	1526237-1	16	1526434-2	16
1526076-2	29	1526161-1	14	1526237-2	16	1526436-1	18
1526081-3	29	1526161-2	14	1526240-1	18	1526436-2	18
1526083-2	29	1526163-1	16	1526242-1	12	1526437-1	12
1526088-3	29	1526163-2	16	1526242-2	12	1526437-2	12
1526089-2	29	1526166-1	12	1526243-2	14	1526438-2	14
1526094-3	29	1526166-2	12	1526245-1	16	1526442-1	18
1526095-2	29	1526167-1	14	1526251-1	12	1526442-2	18
1526096-3	29	1526167-2	14	1526251-2	12	1526443-1	14
1526097-2	29	1526168-1	16	1526252-1	14	1526443-2	14
1526098-3	29	1526168-2	16	1526252-2	14	1526445-2	16
1526099-2	29	1526169-1	16	1526253-1	16	1526447-2	18
1526100-3	29	1526169-2	16	1526258-1	12	1526452-1	12
1526101-2	29	1526170-1	18	1526258-2	12	1526452-2	12
1526102-3	29	1526170-2	18	1526259-1	14	1526453-1	14
1526103-2	29	1526171-1	18	1526259-2	14	1526453-2	14
1526104-3	29	1526171-2	18	1526262-1	18	1526454-2	16
1526105-2	29	1526173-1	12	1526267-1	12	1526455-1	16
1526106-3	29	1526173-2	12	1526267-2	12	1526455-2	16
1526107-2	29	1526174-1	14	1526268-1	14	1526457-1	18
1526108-3	29	1526174-2	14	1526268-2	14	1526459-1	12
1526109-1	12	1526181-1	12	1526272-2	16	1526459-2	12
1526109-2	12	1526181-2	12	1526273-2	16	1526465-1	12
1526110-1	14	1526182-1	14	1526282-1	12	1526465-2	12
1526110-2	14	1526182-2	14	1526282-2	12	1526466-1	14
1526111-1	16	1526187-1	12	1526283-1	14	1526466-2	14
1526111-2	16	1526187-2	12	1526283-2	14	1526479-1	12
1526115-1	12	1526188-1	14	1526284-2	16	1526479-2	12
1526115-2	12	1526188-2	14	1526285-2	16	1526480-1	14
1526116-1	14	1526190-1	16	1526287-2	18	1526480-2	14
1526116-2	14	1526190-2	16	1526290-1	12	1526486-2	16
1526117-1	16	1526193-1	12	1526290-2	12	1526487-2	16
1526117-2	16	1526193-2	12	1526291-1	14	1526490-1	12

Dimensions are in inches and millimeters unless otherwise specified. Values in brackets are metric equivalents.

Dimensions are shown for reference purposes only. Specifications subject to change.

Technical Support
 USA: 1-800-522-6752
 Canada: 1-905-475-6222
 Mexico: 01-800-733-8926

www.tycoelectronics.com

Part Number Index (Continued)

Part No.	Page	Part No.	Page	Part No.	Page	Part No.	Page
1526490-2	12	1526782-2	15	1526878-2	17	1526985-2	19
1526491-1	14	1526783-1	17	1526879-1	18	1526987-2	19
1526491-2	14	1526783-2	17	1526880-1	18	1526989-2	19
1526596-1	12	1526784-1	17	1526883-1	13	1526990-3	21
1526596-2	12	1526784-2	17	1526883-2	13	1526991-3	21
1526597-1	14	1526786-1	18	1526884-1	15	1526992-3	21
1526597-2	14	1526788-1	18	1526884-2	15	1526993-3	21
1526701-2	18	1526793-1	13	1526892-1	13	1526994-3	21
1526704-1	12	1526793-2	13	1526892-2	13	1526995-3	21
1526704-2	12	1526794-2	15	1526893-1	15	1526996-3	21
1526705-1	14	1526796-2	17	1526893-2	15	1526997-3	21
1526705-2	14	1526799-1	13	1526896-1	17	1526998-3	21
1526706-1	17	1526799-2	13	1526897-2	17	1527096-3	20
1526706-2	17	1526800-1	15	1526899-1	18	1527115-3	20
1526707-1	17	1526800-2	15	1526899-2	18	1527117-3	20
1526707-2	17	1526804-1	18	1526901-1	18	1527119-3	20
1526708-1	18	1526805-1	13	1526901-2	18	1527120-3	20
1526713-1	12	1526805-2	13	1526911-1	13	1527121-3	20
1526713-2	12	1526806-1	15	1526911-2	13	1527122-3	20
1526714-1	14	1526806-2	15	1526912-1	15	1527123-3	20
1526714-2	14	1526809-1	17	1526912-2	15	1527124-3	20
1526715-2	17	1526810-1	17	1526913-1	17	1527125-3	20
1526716-1	17	1526810-2	17	1526914-1	17	1527126-3	20
1526716-2	17	1526813-1	18	1526914-2	17	1527127-3	20
1526719-1	12	1526819-1	13	1526916-1	18	1527128-3	20
1526719-2	12	1526819-2	13	1526918-1	18	1527129-3	20
1526720-1	14	1526820-1	15	1526918-2	18	1527130-3	20
1526720-2	14	1526820-2	15	1526922-1	13	1527131-3	20
1526726-1	18	1526822-1	17	1526922-2	13	1527132-3	20
1526727-1	18	1526822-2	17	1526923-1	15	1527135-3	20
1526731-1	12	1526824-1	18	1526923-2	15	1527136-3	20
1526731-2	12	1526830-1	13	1526928-1	13	1527137-3	20
1526732-1	14	1526830-2	13	1526928-2	13	1527138-3	20
1526732-2	14	1526831-1	15	1526929-1	15	1527139-3	20
1526735-1	18	1526831-2	15	1526929-2	15	1527140-3	20
1526736-1	18	1526837-1	13	1526934-1	13	1527141-3	20
1526738-1	13	1526837-2	13	1526934-2	13	1527142-3	20
1526738-2	13	1526838-2	15	1526937-2	17	1527143-3	20
1526739-1	15	1526844-1	13	1526941-1	13	1527144-3	20
1526739-2	15	1526844-2	13	1526941-2	13	1527146-3	20
1526743-1	18	1526845-2	15	1526945-1	18	1527147-3	20
1526743-2	18	1526848-2	17	1526945-2	18	1527148-3	20
1526745-1	13	1526849-1	17	1526946-1	18	1527149-3	20
1526745-2	13	1526849-2	17	1526946-2	18	1527150-3	20
1526746-1	15	1526852-1	13	1526950-2	10	1527151-3	20
1526746-2	15	1526852-2	13	1526961-2	19	1527152-3	20
1526747-2	17	1526853-1	15	1526962-2	19	1527153-3	20
1526751-1	18	1526853-2	15	1526963-2	19	1527154-3	20
1526751-2	18	1526854-1	17	1526965-2	19	1527155-3	20
1526758-1	13	1526854-2	17	1526966-2	19	1527156-3	20
1526758-2	13	1526856-1	17	1526967-2	19	1527157-3	20
1526759-1	15	1526856-2	17	1526968-2	19	1527158-3	20
1526759-2	15	1526857-1	18	1526969-2	19	1527159-3	20
1526764-1	17	1526862-1	15	1526970-2	19	1527160-3	20
1526764-2	17	1526862-2	15	1526971-2	19	1527161-1	20
1526769-1	17	1526863-1	13	1526972-2	19	1527162-3	20
1526769-2	17	1526863-2	13	1526979-2	19	1527163-3	20
1526770-1	18	1526868-1	18	1526980-2	19	1527164-3	20
1526772-1	18	1526873-1	13	1526981-2	19	1527165-3	20
1526781-1	13	1526873-2	13	1526982-2	19	1527166-3	20
1526781-2	13	1526874-1	15	1526983-2	19	1527208-3	22
1526782-1	15	1526874-2	15	1526984-2	19	1527209-3	22

Part Number Index (Continued)

Part No.	Page	Part No.	Page	Part No.	Page	Part No.	Page
1527210-3	22	1527270-3	22	1527327-3	24	1527384-3	26
1527211-3	22	1527272-3	23	1527328-3	24	1527385-3	26
1527214-3	22	1527273-3	23	1527329-3	24	1527386-3	26
1527215-3	22	1527277-3	23	1527330-3	24	1527387-3	26
1527216-3	22	1527278-3	23	1527331-3	24	1527388-3	26
1527217-3	22	1527279-3	23	1527332-3	24	1527389-3	26
1527219-3	22	1527280-3	23	1527334-3	24	1527390-3	26
1527220-3	22	1527281-3	23	1527335-3	24	1527392-3	26
1527221-3	22	1527283-3	23	1527336-3	24	1527393-3	27
1527222-3	22	1527284-3	23	1527337-3	24	1527394-3	27
1527225-3	22	1527285-3	23	1527340-3	24	1527395-3	27
1527226-3	22	1527286-3	23	1527341-3	24	1527397-3	27
1527227-3	22	1527287-3	23	1527343-3	24	1527398-3	27
1527228-3	22	1527288-3	23	1527344-3	25	1527399-3	27
1527229-3	22	1527291-3	23	1527347-3	25	1527400-3	27
1527230-3	22	1527293-3	23	1527351-3	25	1527401-3	27
1527231-3	22	1527294-3	23	1527353-3	25	1527402-3	27
1527232-3	22	1527296-3	23	1527355-3	25	1527403-3	27
1527233-3	22	1527297-3	23	1527357-3	25	1527404-3	27
1527234-3	22	1527298-3	23	1527358-3	25	1527405-3	27
1527235-3	22	1527300-3	23	1527359-3	25	1527406-3	27
1527237-3	22	1527301-3	23	1527360-3	25	1527407-3	27
1527238-3	22	1527302-3	23	1527361-3	25	1527473-2	10
1527240-3	22	1527303-3	23	1527362-3	25	1527480-2	10
1527242-3	22	1527304-3	23	1527363-3	25	1527514-2	10
1527243-3	22	1527305-3	23	1527364-3	25	1527516-2	10
1527244-3	22	1527306-3	23	1527365-3	25	1527523-1	10
1527247-3	22	1527307-3	23	1527366-3	25	1527526-2	10
1527249-3	22	1527309-3	24	1527367-3	25	1527529-2	10
1527251-3	22	1527311-3	24	1527369-3	25	1527530-2	10
1527253-3	22	1527313-3	24	1527370-3	25	1527531-2	10
1527255-3	22	1527315-3	24	1527371-3	25	1527539-2	10
1527256-3	22	1527317-3	24	1527373-3	25	1527546-2	10
1527258-3	22	1527318-3	24	1527374-3	25	1527548-2	10
1527259-3	22	1527319-3	24	1527375-3	25	1527555-2	10
1527260-3	22	1527320-3	24	1527377-3	25	1527589-3	24
1527261-3	22	1527321-3	24	1527378-3	25	1527590-3	24
1527263-3	22	1527322-3	24	1527379-3	26	1527593-3	24
1527264-3	26	1527323-3	24	1527380-3	26		
1527266-3	22	1527324-3	24	1527381-3	26		
1527267-3	22	1527325-3	24	1527382-3	26		
1527268-3	22	1527326-3	24	1527383-3	26		

Tooling Part Number Index

Part No.	Page
1526955-1	30
1527505-1	30
1527507-1	30
1527508-1	30

tyco

TYCO ELECTRONICS CORPORATION
HARRISBURG, PA 17105

AMP

Electronics

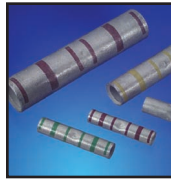

**H E A V Y D U T Y S E A M L E S S
T E R M I N A L S & S P L I C E S**

Looking for pricing, stock, or lifecycle information?

Click below to explore more details on WIN SOURCE:

 [View 1526596-2 on WIN SOURCE](#)

 [TE Connectivity](#) Information

Optimize Your Supply Chain with WIN SOURCE Solutions

-  Global Sourcing Solution
-  Obsolete Management
-  Cost Control Management
-  Shortage Management
-  Alternative Solution
-  Excess Inventory Management