

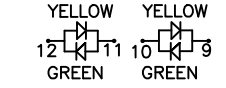

**THE DATASHEET OF
E5J88-224J22-L**

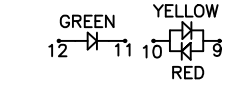

REVISION RECORD				
REV	ECO	DESCRIPTION	DRFT	CHKD
▲		DRAWING MODIFY	yanglan	08/09/05

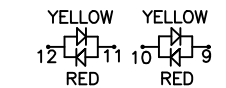
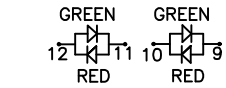
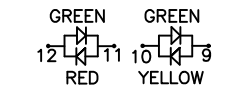
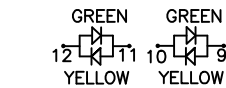
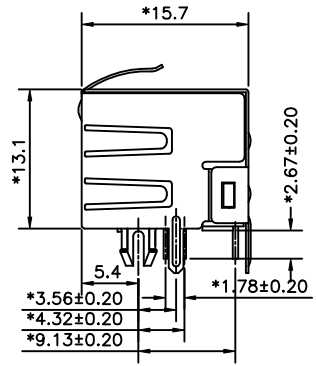
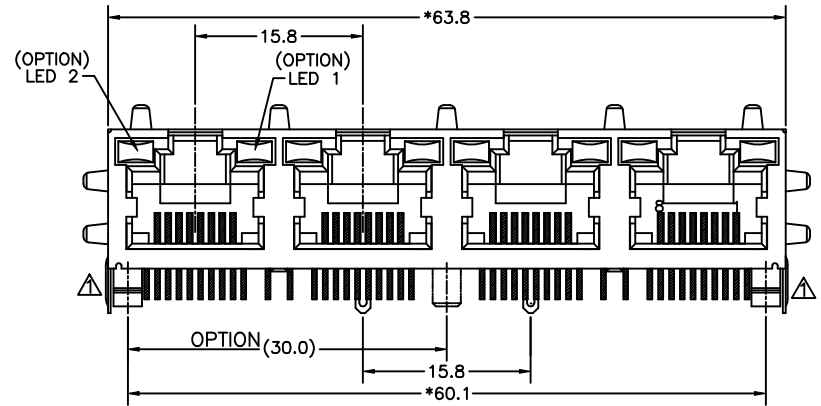
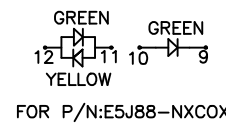
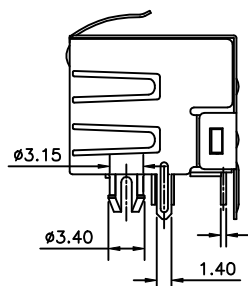
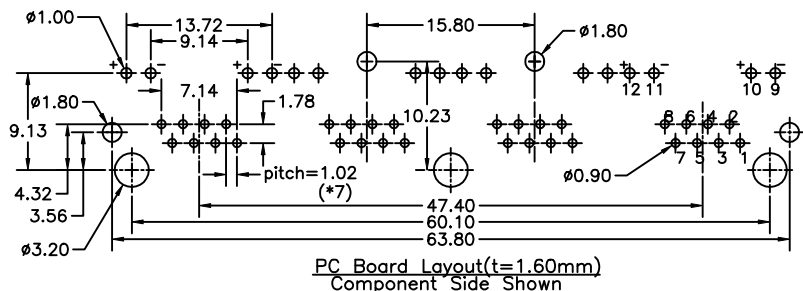

NOTES:

ELECTRICAL:

- VOLTAGE RATING : 125 VAC RMS.
- CURRENT RATING : 1.5 AMP.
- CONTACT RESISTANCE : 30 MILLIOHMS MAX.
- INSULATION RESISTANCE: 1000 MEGOHMS MIN @ 500 VDC.
- DIELECTRIC STRENGTH : 1000 VAC RMS 60Hz, 1MIN.
- LED RATINGS: FORWARD VOLTAGE: 2.2 VOLTS TYPICAL.
REVERSE VOLTAGE: 5 VOLTS MAXIMUM
- OPERATING: 750 CYCLES MIN.

MECHANICAL:

- HOUSING MATERIAL : FR52 UL94V-0. COLOR-BLACK.
- INSERT MATERIAL : FR52 UL94V-0. COLOR-BLACK.
- BACK PLATE MATERIAL : FR52 COLOR-BLACK.
- LED SIZE : 3.2*2.0*7.0*P=2.54mm.
- SHIELD MATERIAL : COPPER ALLOY 0.25mm THICKNESS PLATING NI.
- CONTACT MATERIAL : PHOSPHOR BRONZE 0.35mm THICKNESS .
- PLATING : GOLD PLATING OVER NICKEL.
- PCB RETENTION PRE-SOLDER : 1 LB MIN.
- PCB RETENTION POST-SOLDER: 10 LBS MIN.

ENVIRONMENTAL:

- STORAGE : -40°C TO +85°C.
 - OPERATION: 0°C TO 70°C.
 - WAVE SOLDERING TEMPERATURE: 255~265°C (5~10 SECONDS)
- MATES WITH MODULAR PLUG CONFORMING TO FCC PART 68, SUBPART F. CUL FILE No:E163191

PART NUMBER: E 5 J 8 8 - X X X J X X - L

- 1-LED1:GREEN ,LED2:YELLOW.
- 2-LED1:GREEN ,LED2:GREEN .
- 3-LED1:YELLOW ,LED2:GREEN .
- 4-LED1:G+Y ,LED2:G+Y .
- 5-LED1:RED ,LED2:GREEN .
- 7-LED1:YELLOW ,LED2:YELLOW .
- D-LED1:G+R ,LED2:G+R .
- E-LED1:GREEN ,LED2:RED .
- N-LED1:GREEN ,LED2:G+Y .
- P-LED1:Y+R ,LED2:GREEN .
- Q-LED1:G+Y ,LED2:G+R .
- S-LED1:Y+R ,LED2:Y+R .
- V-LED1:Y+G ,LED2:Y+G .

- PLATING: 1-3u" 2-6u"
- 3-15u" 4-30u" 5-50u"
- 1- PLATE Tin SHIELD,STAMP PIN,LED LONG 7.00
- 2- PLATE Ni SHIELD,STAMP PIN,LED LONG 7.00
- 3- PLATE Tin SHIELD,ROUND PIN,LED LONG 7.00
- 4- PLATE Ni SHIELD,ROUND PIN,LED LONG 7.00
- 4-4 PORTS W/O MIDDLE POLE
- C-4 PORTS W/ MIDDLE POLE
- 0-NO SHIELD
- 1-NO TAB 2-TOP TABS.
- 3-SIDE TABS.
- 4-TOP TABS & SIDE TABS.

← MM (INCH) →		DFTO YANGLAN DATE 06/13/05	FULL RISE ELECTRONIC CO., LTD	
TOLERANCES EXCEPT AS NOTED		CHKD JAKE DATE 2005/08/10		
DETACHED LISTS	MM	±	TITLE	
	.0 ± 0.20	±	RJ45 SIDE ENTRY LED GANG JACK 4 PORTS	
	.00 ± 0.15	±	DRAWING NO. GE5J3128	SIZE A3
	.000 ± 0.075	±	/PART NO. SEE NOTE	
ANGLES ±	QT'Y :		REV 1	
THIRD ANGLE PROJECTION		FINISH :	DO NOT SCALE DRAWING	
		SCALE : 2:1	SHEET 1 OF 1	

Looking for pricing, stock, or lifecycle information?

Click below to explore more details on WIN SOURCE:

 [View E5J88-224J22-L on WIN SOURCE](#)

 [Pulse Information](#)

Optimize Your Supply Chain with WIN SOURCE Solutions

-  Global Sourcing Solution
-  Obsolete Management
-  Cost Control Management
-  Shortage Management
-  Alternative Solution
-  Excess Inventory Management