









**THE DATASHEET OF
JG0-0045NL**





-  Available for 1000BASE-T and 100BASE-TX data rates
-  SMT (surface mount) discrete and THT (through hole) connector modules with integrated magnetics, available with or without LED's.
-  Meets IEEE 802.3af specification for PoE applications
-  Meet IEEE 802.3at specification for PoE+ applications
-  Available for Extended Temp., Low-Profile, PSE, and PD applications
-  X = extended temp, PP = PoE+

DISCRETE MAGNETICS		CONNECTORS WITH INTEGRATED MAGNETICS	
100BASE-TX	1000BASE-T	100BASE-TX	1000BASE-T
SINGLE: H2019NL HX2019NL X H2260NL H1263NL	SINGLE: HX2260NL X HX2326NL X, PP HX1393NL	1X1: JKO-0120NL JKO-0125NL	1X1: JXKO-0138NL X JKO-0144NL JKO-0144BNL JKO-0145NL JKO-0177NL PP JXKO-0190NL X, PP JKO-0161NL JKO-0133NL
DUAL: H2005ANL H2006ANL H2009NL	DUAL: H2039NL H2305NL HX2305NL	1XN: J1N-0011NL (1X4) JG0-0031NL (1X2) JG0-0032NL (1X4) JG0-0045NL (1X6) JG0-0051NL (1X8)	1XN: J0N-0012NL (1X4) J0N-0015NL PP (1X4) J1N-0008NL (1X4) J1N-0003NL PP (1X4)
QUAD: H2014NL H2017NL	QUAD: H1259NL HX1259NL X	2XN: JCO-0114NL (2X6)	2XN: JOB-0182NL (2X4) JOB-0183NL (2X6) JOB-0170NL (2X8)

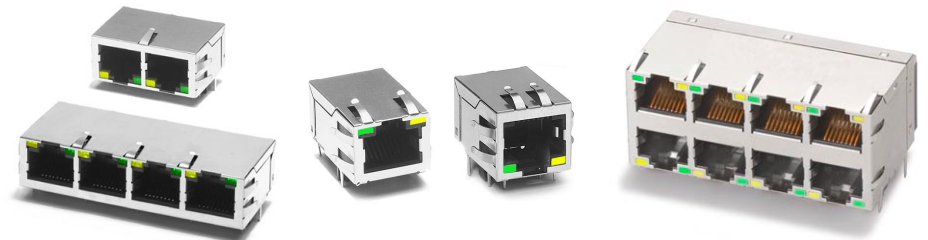
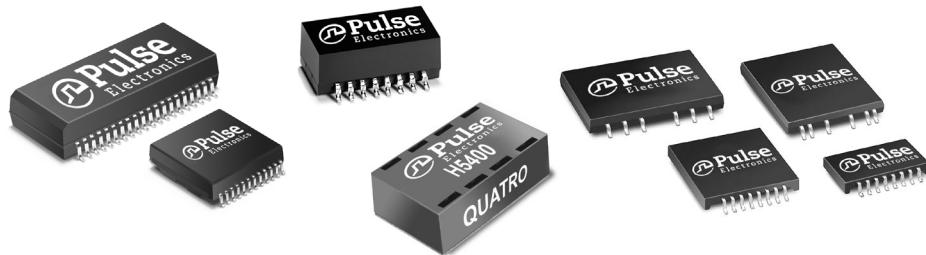



Application Notes

- Layering ground planes is advisable. Route connector/discrete module ground pins to chassis/analog ground if possible.
- Keep signal traces from PHY to connector/discrete module as short as possible. If traces exceed 3-4 inches, pay close attention to line impedance imbalance.

- Using BST (75Ω resistors and high voltage cap to chassis ground) to terminate Cable side CTs is advisable for best EMI performance (included in most connector solutions).
- Follow PHY manufacturer's application notes for further layout considerations.
- Common applications include: VoIP phones, WLAN APs, Security Cameras, POS Terminals, Keycard Access/Security.

100BASE-TX APPLICATION CIRCUIT

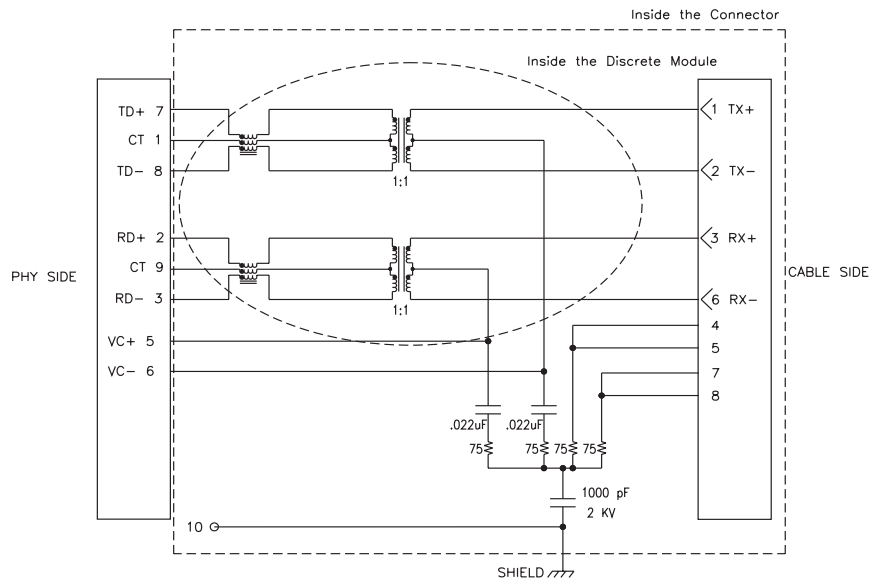

100BASE-T APPLICATION CIRCUIT

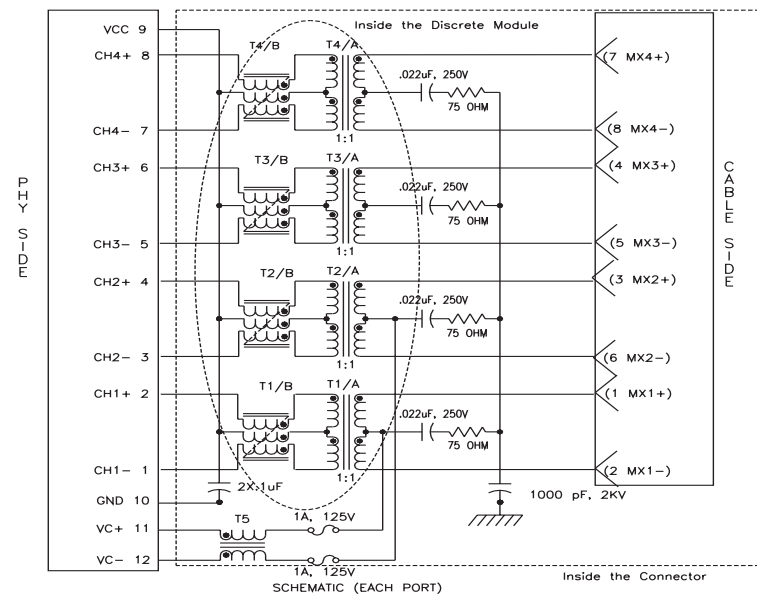

For More Information

Pulse Worldwide Headquarters
12220 World Trade Drive
San Diego, CA 92128
U.S.A.

Pulse Europe
Zeppelinstrasse 15
71083 Herrenberg
Germany

Pulse China Headquarters
B402, Shenzhen Academy of
Aerospace Technology Bldg.
10th Kejinan Road
High-Tech Zone
Nanshan District
Shenzhen, PR China 518057
Tel: 86 755 33966678
Fax: 86 755 33966700

Pulse North China
Room 2704/2705
Super Ocean Finance Ctr.
2067 Yan An Road West
Shanghai 200336
China
Tel: 86 21 62787060
Fax: 86 2162786973

Pulse South Asia
135 Joo Seng Road
#03-02
PM Industrial Bldg.
Singapore 368363

Pulse North Asia
3F, No. 198
Zhongyuan Road
Zhongli City
Taoyuan County 320
Taiwan R. O. C.
Tel: 886 3 4356768
Fax: 886 3 4356823 (Pulse)
Fax: 886 3 4356820 (FRE)

Tel: 858 674 8100
Fax: 858 674 8262

Tel: 49 7032 78060
Fax: 49 7032 7806 135

Tel: 65 6287 8998
Fax: 65 6287 8998

Performance warranty of products offered on this data sheet is limited to the parameters specified. Data is subject to change without notice. Other brand and product names mentioned herein may be trademarks or registered trademarks of their respective owners. © Copyright, 2011. Pulse Electronics, Inc. All rights reserved.

Looking for pricing, stock, or lifecycle information?

Click below to explore more details on WIN SOURCE:

 [View JG0-0045NL on WIN SOURCE](#)

 [Pulse Information](#)

Optimize Your Supply Chain with WIN SOURCE Solutions

-  Global Sourcing Solution
-  Obsolete Management
-  Cost Control Management
-  Shortage Management
-  Alternative Solution
-  Excess Inventory Management