



THE DATASHEET OF HIP4080AIPZ



HIP4080A

80V/2.5A Peak, High Frequency Full Bridge FET Driver

FN3658
Rev.7.00
July 2004

The HIP4080A is a high frequency, medium voltage Full Bridge N-Channel FET driver IC, available in 20 lead plastic SOIC and DIP packages. The HIP4080A includes an input comparator, used to facilitate the “hysteresis” and PWM modes of operation. Its HEN (high enable) lead can force current to freewheel in the bottom two external power MOSFETs, maintaining the upper power MOSFETs off. Since it can switch at frequencies up to 1MHz, the HIP4080A is well suited for driving Voice Coil Motors, switching power amplifiers and power supplies.

HIP4080A can also drive medium voltage brush motors, and two HIP4080As can be used to drive high performance stepper motors, since the short minimum “on-time” can provide fine micro-stepping capability.

Short propagation delays of approximately 55ns maximize control loop crossover frequencies and dead-times which can be adjusted to near zero to minimize distortion, resulting in precise control of the driven load.

The similar HIP4081A IC allows independent control of all 4 FETs in a Full Bridge configuration.

The Application Note for the HIP4080A is AN9404.

Ordering Information

PART NUMBER	TEMPERATURE RANGE (°C)	PACKAGE	PKG. DWG. #
HIP4080AIPZ (Note 1)	-40 to +85	20 Ld PDIP (Pb-Free)	E20.3
HIP4080AIP	-40 to +85	20 Ld PDIP	E20.3
HIP4080AIB	-40 to +85	20 Ld SOIC	M20.3
HIP4080AIBZ (Note 1)	-40 to +85	20 Ld SOIC (Pb-Free)	M20.3

NOTES:

- Intersil Pb-Free products employ special Pb-free material sets; molding compounds/die attach materials and 100% matte tin plate termination finish, which is compatible with both SnPb and Pb-free soldering operations. Intersil Pb-Free products are MSL classified at Pb-free peak reflow temperatures that meet or exceed the Pb-free requirements of IPC/JEDEC J Std-020B.
- Add “T” suffix for Tape and Reel packing option. HIP4080AIP not available in Tape and Reel.

Features

- Drives N-Channel FET Full Bridge Including High Side Chop Capability
- Bootstrap Supply Max Voltage to 95VDC
- Drives 1000pF Load at 1MHz in Free Air at +50°C with Rise and Fall Times of Typically 10ns
- User-Programmable Dead Time
- Charge-Pump and Bootstrap Maintain Upper Bias Supplies
- DIS (Disable) Pin Pulls Gates Low
- Input Logic Thresholds Compatible with 5V to 15V Logic Levels
- Very Low Power Consumption
- Undervoltage Protection
- Pb-Free Available as an Option

Applications

- Medium/Large Voice Coil Motors
- Full Bridge Power Supplies
- Switching Power Amplifiers
- High Performance Motor Controls
- Noise Cancellation Systems
- Battery Powered Vehicles
- Peripherals
- U.P.S.

Pinout

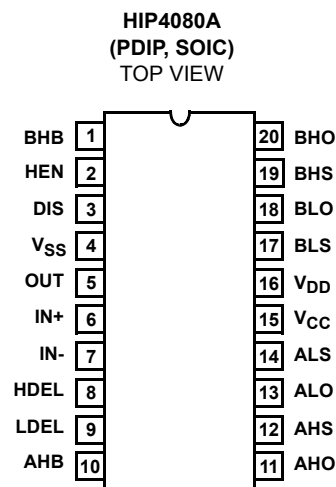

Application Block Diagram

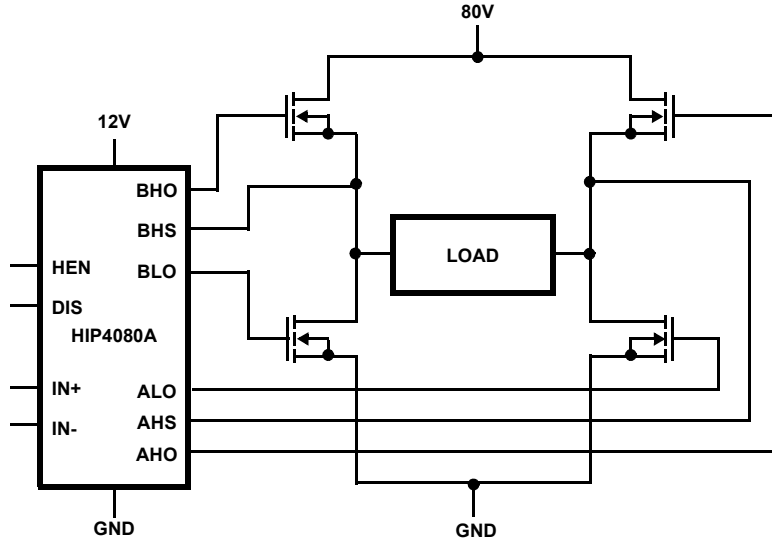

Functional Block Diagram (1/2 HIP4080A)

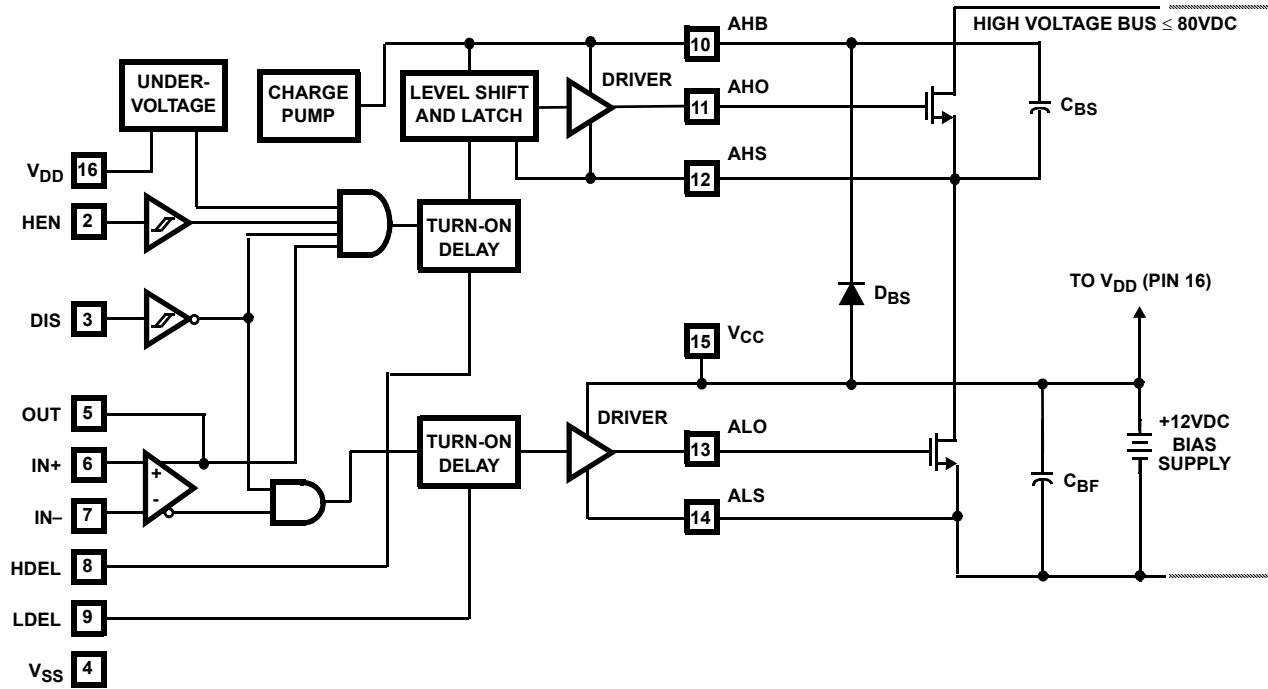

Absolute Maximum Ratings

Supply Voltage, V_{DD} and V_{CC} -0.3V to 16V
 Logic I/O Voltages -0.3V to V_{DD} +0.3V
 Voltage on AHS, BHS ... -6.0V (Transient) to 80V (25°C to 125°C)
 Voltage on AHS, BHS ... -6.0V (Transient) to 70V (-55°C to 125°C)
 Voltage on ALS, BLS -2.0V (Transient) to +2.0V (Transient)
 Voltage on AHB, BHB V_{AHS} , BHS -0.3V to V_{AHS} , BHS + V_{DD}
 Voltage on ALO, BLO V_{ALS} , BLS -0.3V to V_{CC} +0.3V
 Voltage on AHO, BHO V_{AHS} , BHS -0.3V to V_{AHB} , BHB +0.3V
 Input Current, HDEL and LDEL -5mA to 0mA
 Phase Slew Rate 20V/ns
 All Voltages relative to V_{SS} , unless otherwise specified.

Thermal Information

Thermal Resistance (Typical, Note 3) θ_{JA} (°C/W)
 SOIC Package 85
 PDIP Package 75
 Maximum Power Dissipation at +85°C
 SOIC Package 470mW
 PDIP Package 530mW
 Storage Temperature Range -65°C to +150°C
 Operating Max. Junction Temperature +125°C
 Lead Temperature (Soldering 10s) +300°C
 (For SOIC - Lead Tips Only)

Operating Conditions

Supply Voltage, V_{DD} and V_{CC} +9.5V to +15V
 Voltage on ALS, BLS -1.0V to +1.0V
 Voltage on AHB, BHB V_{AHS} , BHS +5V to V_{AHS} , BHS +15V
 Input Current, HDEL and LDEL -500µA to -50µA
 Operating Ambient Temperature Range -40°C to +85°C

CAUTION: Stresses above those listed in "Absolute Maximum Ratings" may cause permanent damage to the device. This is a stress only rating and operation of the device at these or any other conditions above those indicated in the operational sections of this specification is not implied.

NOTE:

- θ_{JA} is measured with the component mounted on a low effective thermal conductivity test board in free air. See Tech Brief TB379 for details.

Electrical Specifications $V_{DD} = V_{CC} = V_{AHB} = V_{BHB} = 12V$, $V_{SS} = V_{ALS} = V_{BLS} = V_{AHS} = V_{BHS} = 0V$, $R_{HDEL} = R_{LDEL} = 100K$, and $T_A = +25^\circ C$, Unless Otherwise Specified

PARAMETERS	SYMBOL	TEST CONDITIONS	$T_J = +25^\circ C$			$T_J = -40^\circ C$ TO $+125^\circ C$		UNITS
			MIN	TYP	MAX	MIN	MAX	
SUPPLY CURRENTS AND CHARGE PUMPS								
V_{DD} Quiescent Current	I_{DD}	IN- = 2.5V, Other Inputs = 0V	8	11	14	7	14	mA
V_{DD} Operating Current	I_{DDO}	Outputs switching $f = 500kHz$, No Load	9	12	15	8	15	mA
V_{CC} Quiescent Current	I_{CC}	IN- = 2.5V, Other Inputs = 0V, $I_{ALO} = I_{BLO} = 0$	-	25	80	-	100	µA
V_{CC} Operating Current	I_{CCO}	$f = 500kHz$, No Load	1	1.25	2.0	0.8	3	mA
AHB, BHB Quiescent Current - Qpump Output Current	I_{AHB} , I_{BHB}	IN- = 2.5V, Other Inputs = 0V, $I_{AHO} = I_{BHO} = 0$, $V_{DD} = V_{CC} = V_{AHB} = V_{BHB} = 10V$	-50	-25	-11	-60	-10	µA
AHB, BHB Operating Current	I_{AHBO} , I_{BHBO}	$f = 500kHz$, No Load	0.62	1.2	1.5	0.5	1.9	mA
AHS, BHS, AHB, BHB Leakage Current	I_{HLK}	$V_{BHS} = V_{AHS} = 80V$, $V_{AHB} = V_{BHB} = 93V$	-	0.02	1.0	-	10	µA
AHB-AHS, BHB-BHS Qpump Output Voltage	$V_{AHB} - V_{AHS}$ $V_{BHB} - V_{BHS}$	$I_{AHB} = I_{AHS} = 0$, No Load	11.5	12.6	14.0	10.5	14.5	V
INPUT COMPARATOR PINS: IN+, IN-, OUT								
Offset Voltage	V_{OS}	Over Common Mode Voltage Range	-10	0	+10	-15	+15	mV
Input Bias Current	I_{IB}		0	0.5	2	0	4	µA
Input Offset Current	I_{OS}		-1	0	+1	-2	+2	µA
Input Common Mode Voltage Range	CMVR		1	-	$V_{DD} - 1.5$	1	$V_{DD} - 1.5$	V

Electrical Specifications $V_{DD} = V_{CC} = V_{AHB} = V_{BHB} = 12V$, $V_{SS} = V_{ALS} = V_{BLS} = V_{AHS} = V_{BHS} = 0V$, $R_{HDEL} = R_{LDEL} = 100K$, and $T_A = +25^{\circ}C$, Unless Otherwise Specified **(Continued)**

PARAMETERS	SYMBOL	TEST CONDITIONS	$T_J = +25^{\circ}C$			$T_J = -40^{\circ}C$ TO $+125^{\circ}C$		UNITS
			MIN	TYP	MAX	MIN	MAX	
Voltage Gain	AVOL		10	25	-	10	-	V/mV
OUT High Level Output Voltage	V_{OH}	$IN+ > IN-$, $I_{OH} = -250\mu A$	$V_{DD} - 0.4$	-	-	$V_{DD} - 0.5$	-	V
OUT Low Level Output Voltage	V_{OL}	$IN+ < IN-$, $I_{OL} = +250\mu A$	-	-	0.4	-	0.5	V
Low Level Output Current	I_{OL}	$V_{OUT} = 6V$	6.5	14	19	6	20	mA
High Level Output Current	I_{OH}	$V_{OUT} = 6V$	-17	-10	-3	-20	-2.5	mA
INPUT PINS: DIS								
Low Level Input Voltage	V_{IL}	Full Operating Conditions	-	-	1.0	-	0.8	V
High Level Input Voltage	V_{IH}	Full Operating Conditions	2.5	-	-	2.7	-	V
Input Voltage Hysteresis			-	35	-	-	-	mV
Low Level Input Current	I_{IL}	$V_{IN} = 0V$, Full Operating Conditions	-130	-100	-75	-135	-65	μA
High Level Input Current	I_{IH}	$V_{IN} = 5V$, Full Operating Conditions	-1	-	+1	-10	+10	μA
INPUT PINS: HEN								
Low Level Input Voltage	V_{IL}	Full Operating Conditions	-	-	1.0	-	0.8	V
High Level Input Voltage	V_{IH}	Full Operating Conditions	2.5	-	-	2.7	-	V
Input Voltage Hysteresis			-	35	-	-	-	mV
Low Level Input Current	I_{IL}	$V_{IN} = 0V$, Full Operating Conditions	-260	-200	-150	-270	-130	μA
High Level Input Current	I_{IH}	$V_{IN} = 5V$, Full Operating Conditions	-1	-	+1	-10	+10	μA
TURN-ON DELAY PINS: LDEL AND HDEL								
LDEL, HDEL Voltage	V_{HDEL}, V	$I_{HDEL} = I_{LDEL} = -100\mu A$	4.9	5.1	5.3	4.8	5.4	V
GATE DRIVER OUTPUT PINS: ALO, BLO, AHO, AND BHO								
Low Level Output Voltage	V_{OL}	$I_{OUT} = 100mA$	0.7	0.85	1.0	0.5	1.1	V
High Level Output Voltage	$V_{CC} - V_{OH}$	$I_{OUT} = -100mA$	0.8	0.95	1.1	0.5	1.2	V
Peak Pullup Current	I_{O+}	$V_{OUT} = 0V$	1.7	2.6	3.8	1.4	4.1	A
Peak Pulldown Current	I_{O-}	$V_{OUT} = 12V$	1.7	2.4	3.3	1.3	3.6	A
Under Voltage, Rising Threshold	UV+		8.1	8.8	9.4	8.0	9.5	V
Under Voltage, Falling Threshold	UV-		7.6	8.3	8.9	7.5	9.0	V
Under Voltage, Hysteresis	HYS		0.25	0.4	0.65	0.2	0.7	V

Switching Specifications $V_{DD} = V_{CC} = V_{AHB} = V_{BHB} = 12V$, $V_{SS} = V_{ALS} = V_{BLS} = V_{AHS} = V_{BHS} = 0V$, $R_{HDEL} = R_{LDEL} = 10K$,
 $C_L = 1000pF$, and $T_A = +25^{\circ}C$, Unless Otherwise Specified

PARAMETERS	SYMBOL	TEST CONDITIONS	$T_J = +25^{\circ}C$			$T_J = -40^{\circ}C$ TO $+125^{\circ}C$		UNITS
			MIN	TYP	MAX	MIN	MAX	
Lower Turn-off Propagation Delay (IN+/IN- to ALO/BLO)	T_{LPHL}		-	40	70	-	90	ns
Upper Turn-off Propagation Delay (IN+/IN- to AHO/BHO)	T_{HPHL}		-	50	80	-	110	ns
Lower Turn-on Propagation Delay (IN+/IN- to ALO/BLO)	T_{LPLH}		-	40	70	-	90	ns
Upper Turn-on Propagation Delay (IN+/IN- to AHO/BHO)	T_{HPLH}		-	70	110	-	140	ns
Rise Time	T_R		-	10	25	-	35	ns
Fall Time	T_F		-	10	25	-	35	ns
Turn-on Input Pulse Width	$T_{PWIN-ON}$		50	-	-	50	-	ns
Turn-off Input Pulse Width	$T_{PWIN-OFF}$		40	-	-	40	-	ns
Disable Turn-off Propagation Delay (DIS - Lower Outputs)	T_{DISLOW}		-	45	75	-	95	ns
Disable Turn-off Propagation Delay (DIS - Upper Outputs)	$T_{DISHIGH}$		-	55	85	-	105	ns
Disable to Lower Turn-on Propagation Delay (DIS - ALO and BLO)	T_{DLPLH}		-	45	70	-	90	ns
Refresh Pulse Width (ALO and BLO)	T_{REF-PW}		240	380	500	200	600	ns
Disable to Upper Enable (DIS - AHO and BHO)	T_{UEN}		-	480	630	-	750	ns
HEN-AHO, BHO Turn-off, Propagation Delay	$T_{HEN-PHL}$	$R_{HDEL} = R_{LDEL} = 10K$	-	40	70	-	90	ns
HEN-AHO, BHO Turn-on, Propagation Delay	$T_{HEN-PLH}$	$R_{HDEL} = R_{LDEL} = 10K$	-	60	90	-	110	ns

TRUTH TABLE

INPUT				OUTPUT			
IN+ > IN-	HEN	U/V	DIS	ALO	AHO	BLO	BHO
X	X	X	1	0	0	0	0
0	0	0	0	1	0	0	0
1	1	0	0	0	1	1	0
0	1	0	0	1	0	0	1
1	0	0	0	0	0	1	0
X	X	1	X	0	0	0	0

Pin Descriptions

PIN NUMBER	SYMBOL	DESCRIPTION
1	BHB	B High-side Bootstrap supply. External bootstrap diode and capacitor are required. Connect cathode of bootstrap diode and positive side of bootstrap capacitor to this pin. Internal charge pump supplies 30 μ A out of this pin to maintain bootstrap supply. Internal circuitry clamps the bootstrap supply to approximately 12.8V.
2	HEN	High-side Enable input. Logic level input that when low overrides IN+/IN- (Pins 6 and 7) to put AHO and BHO drivers (Pins 11 and 20) in low output state. When HEN is high AHO and BHO are controlled by IN+/IN- inputs. The pin can be driven by signal levels of 0V to 15V (no greater than V _{DD}).
3	DIS	DISable input. Logic level input that when taken high sets all four outputs low. DIS high overrides all other inputs. When DIS is taken low the outputs are controlled by the other inputs. The pin can be driven by signal levels of 0V to 15V (no greater than V _{DD}).
4	V _{SS}	Chip negative supply, generally will be ground.
5	OUT	OUTput of the input control comparator. This output can be used for feedback and hysteresis.
6	IN+	Noninverting input of control comparator. If IN+ is greater than IN- (Pin 7) then ALO and BHO are low level outputs and BLO and AHO are high level outputs. If IN+ is less than IN- then ALO and BHO are high level outputs and BLO and AHO are low level outputs. DIS (Pin 3) high level will override IN+/IN- control for all outputs. HEN (Pin 2) low level will override IN+/IN- control of AHO and BHO. When switching in four quadrant mode, dead time in a half bridge leg is controlled by HDEL and LDEL (Pins 8 and 9).
7	IN-	Inverting input of control comparator. See IN+ (Pin 6) description.
8	HDEL	High-side turn-on DELay. Connect resistor from this pin to V _{SS} to set timing current that defines the turn-on delay of both high-side drivers. The low-side drivers turn-off with no adjustable delay, so the HDEL resistor guarantees no shoot-through by delaying the turn-on of the high-side drivers. HDEL reference voltage is approximately 5.1V.
9	LDEL	Low-side turn-on DELay. Connect resistor from this pin to V _{SS} to set timing current that defines the turn-on delay of both low-side drivers. The high-side drivers turn-off with no adjustable delay, so the LDEL resistor guarantees no shoot-through by delaying the turn-on of the low-side drivers. LDEL reference voltage is approximately 5.1V.
10	AHB	A High-side Bootstrap supply. External bootstrap diode and capacitor are required. Connect cathode of bootstrap diode and positive side of bootstrap capacitor to this pin. Internal charge pump supplies 30 μ A out of this pin to maintain bootstrap supply. Internal circuitry clamps the bootstrap supply to approximately 12.8V.
11	AHO	A High-side Output. Connect to gate of A High-side power MOSFET.
12	AHS	A High-side Source connection. Connect to source of A High-side power MOSFET. Connect negative side of bootstrap capacitor to this pin.
13	ALO	A Low-side Output. Connect to gate of A Low-side power MOSFET.
14	ALS	A Low-side Source connection. Connect to source of A Low-side power MOSFET.
15	V _{CC}	Positive supply to gate drivers. Must be same potential as V _{DD} (Pin 16). Connect to anodes of two bootstrap diodes.
16	V _{DD}	Positive supply to lower gate drivers. Must be same potential as V _{CC} (Pin 15). De-couple this pin to V _{SS} (Pin 4).
17	BLS	B Low-side Source connection. Connect to source of B Low-side power MOSFET.
18	BLO	B Low-side Output. Connect to gate of B Low-side power MOSFET.
19	BHS	B High-side Source connection. Connect to source of B High-side power MOSFET. Connect negative side of bootstrap capacitor to this pin.
20	BHO	B High-side Output. Connect to gate of B High-side power MOSFET.

Timing Diagrams

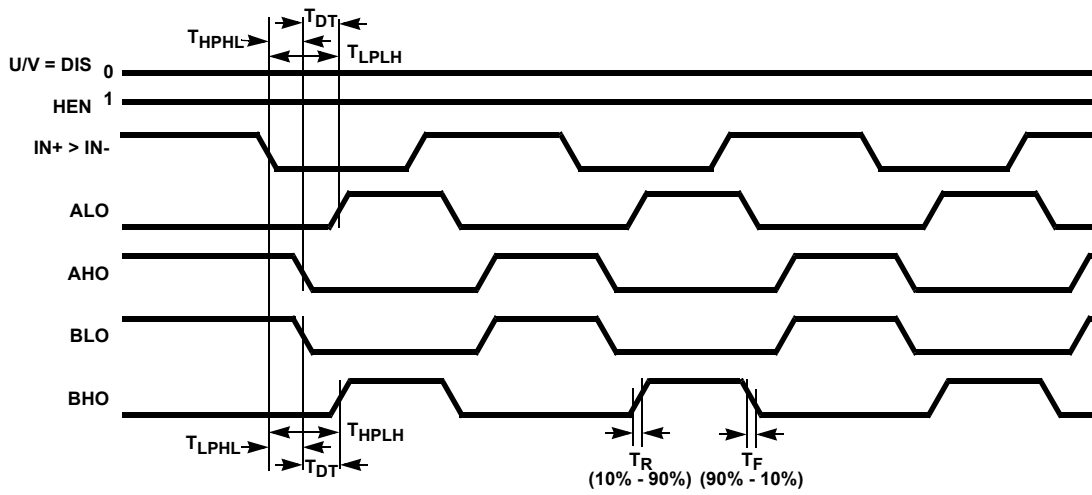

FIGURE 1. BISTATE MODE

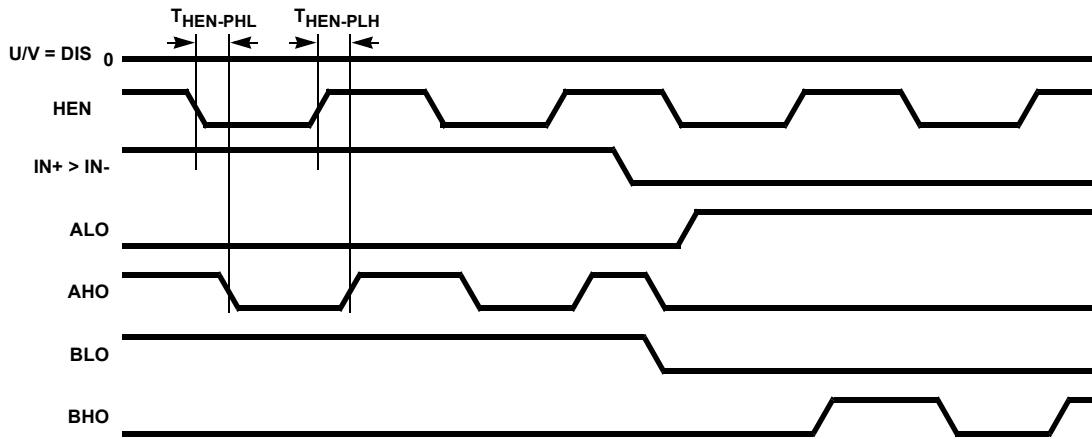

FIGURE 2. HIGH SIDE CHOP MODE

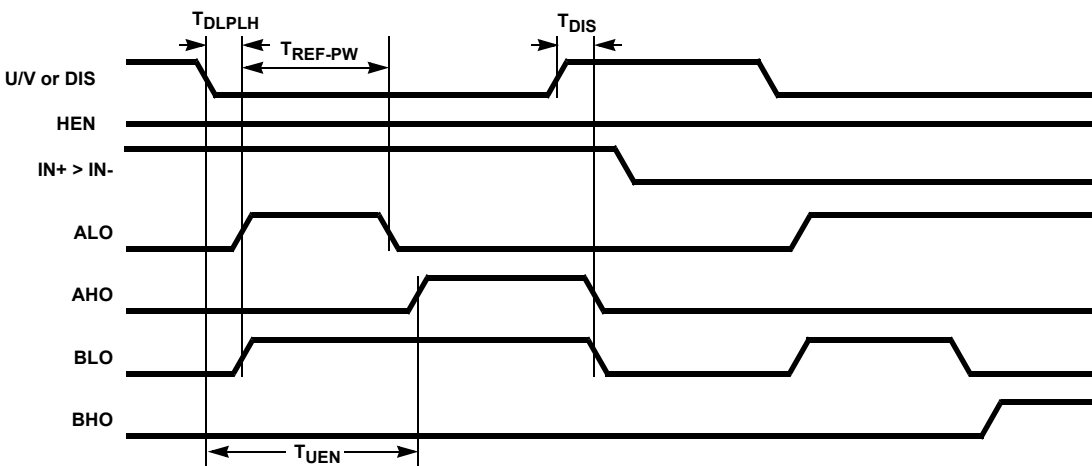

FIGURE 3. DISABLE FUNCTION

Typical Performance Curves $V_{DD} = V_{CC} = V_{AHB} = V_{BHB} = 12V$, $V_{SS} = V_{ALS} = V_{BLS} = V_{AHS} = V_{BHS} = 0V$, $R_{HDEL} = R_{LDEL} = 100K$, and $T_A = +25^\circ C$, Unless Otherwise Specified

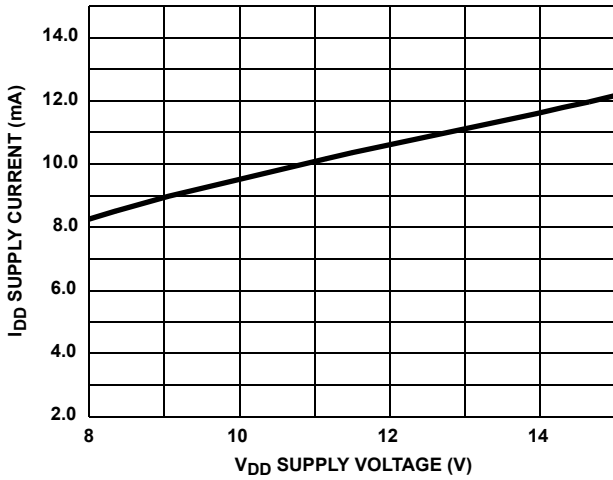

FIGURE 4. QUIESCENT I_{DD} SUPPLY CURRENT vs V_{DD} SUPPLY VOLTAGE

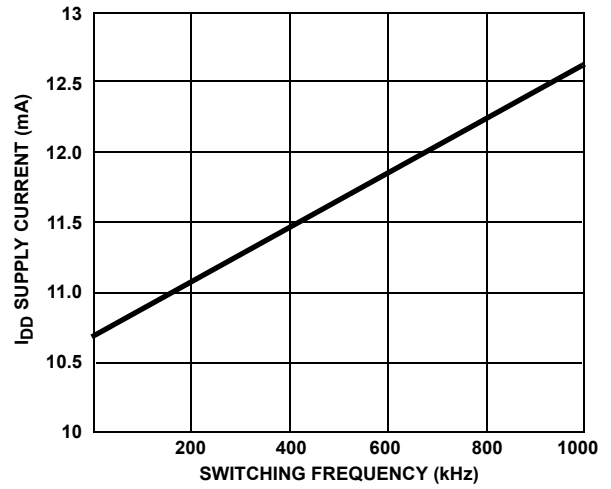

FIGURE 5. I_{DD0} NO-LOAD I_{DD} SUPPLY CURRENT vs FREQUENCY (kHz)

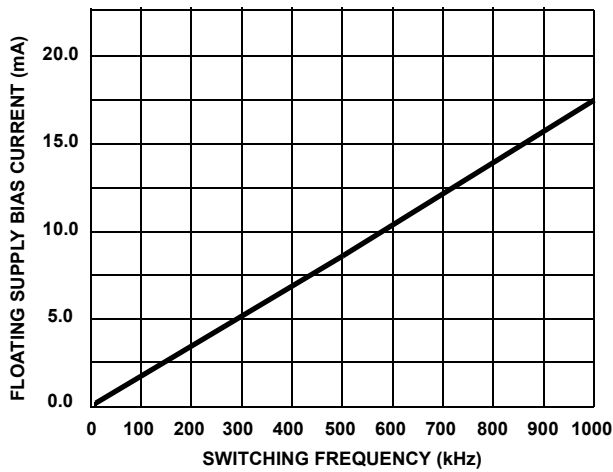

FIGURE 6. SIDE A, B FLOATING SUPPLY BIAS CURRENT vs FREQUENCY (LOAD = 1000pF)

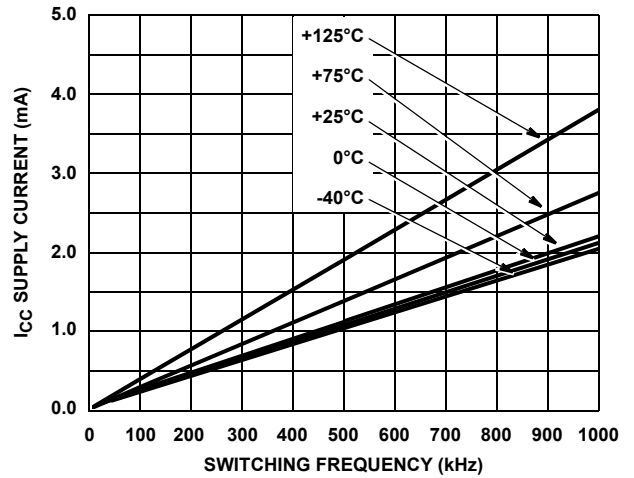

FIGURE 7. I_{CC0}, NO-LOAD I_{CC} SUPPLY CURRENT vs FREQUENCY (kHz) TEMPERATURE

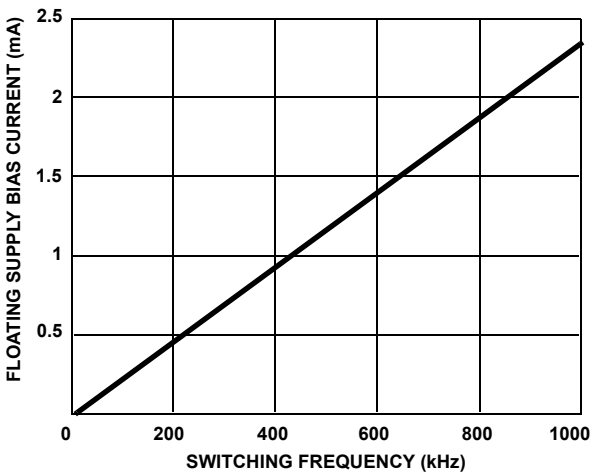

FIGURE 8. I_{AHB}, I_{BHB} NO-LOAD FLOATING SUPPLY BIAS CURRENT vs FREQUENCY

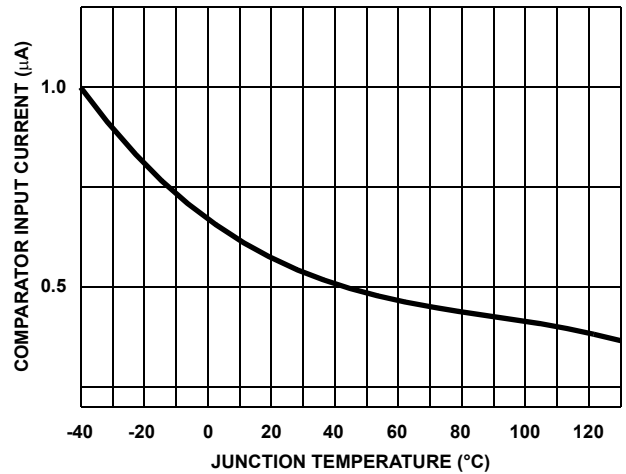

FIGURE 9. COMPARATOR INPUT CURRENT I_L vs TEMPERATURE AT V_{CM} = 5V

Typical Performance Curves $V_{DD} = V_{CC} = V_{AHB} = V_{BHB} = 12V$, $V_{SS} = V_{ALS} = V_{BLS} = V_{AHS} = V_{BHS} = 0V$, $R_{HDEL} = R_{LDEL} = 100K$, and $T_A = +25^\circ C$, Unless Otherwise Specified **(Continued)**

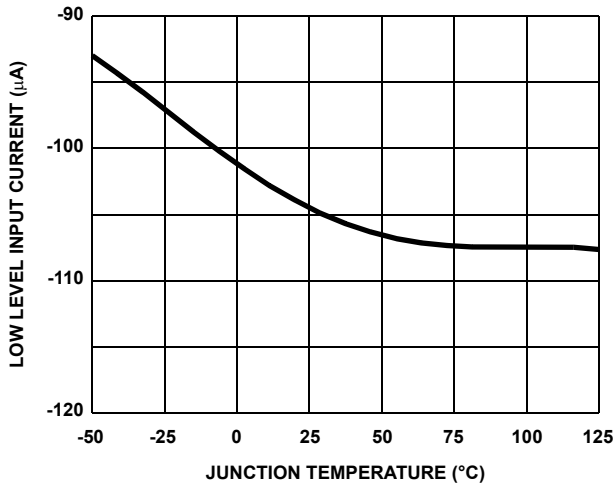

FIGURE 10. DIS LOW LEVEL INPUT CURRENT I_{IL} vs TEMPERATURE

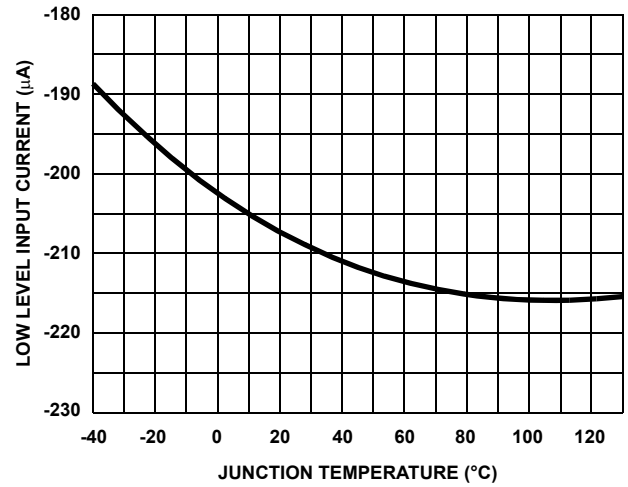

FIGURE 11. HEN LOW LEVEL INPUT CURRENT I_{IL} vs TEMPERATURE

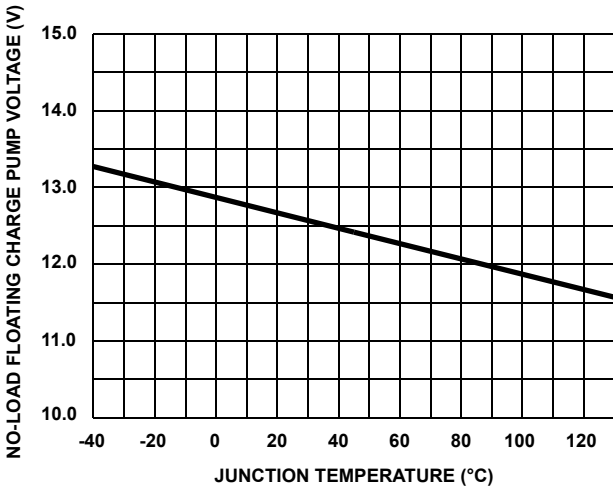

FIGURE 12. AHB - AHS, BHB - BHS NO-LOAD CHARGE PUMP VOLTAGE vs TEMPERATURE

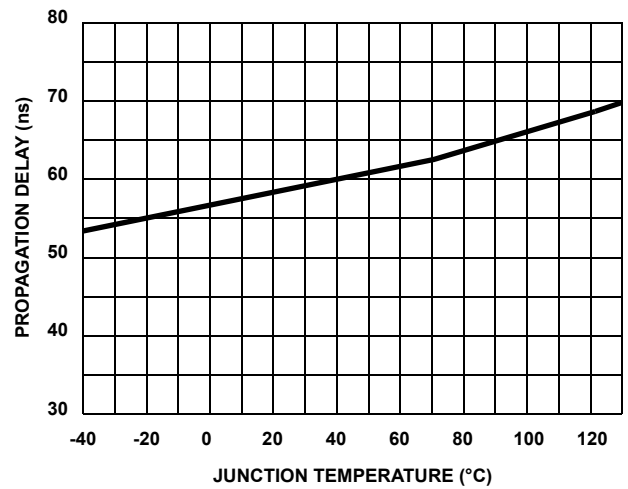

FIGURE 13. UPPER DISABLE TURN-OFF PROPAGATION DELAY $T_{DISHIGH}$ vs TEMPERATURE

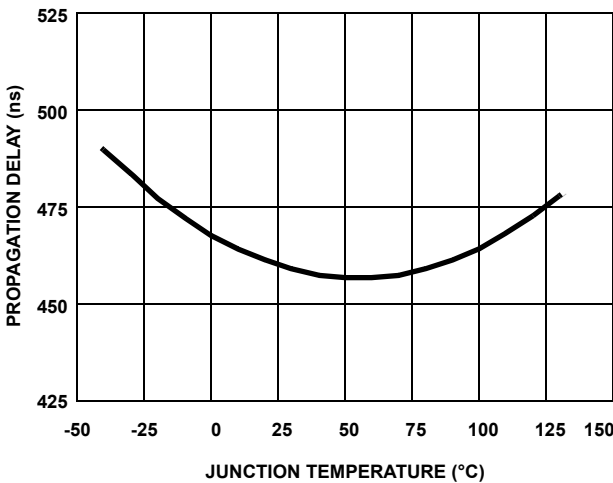

FIGURE 14. DISABLE TO UPPER ENABLE T_{UEN} PROPAGATION DELAY vs TEMPERATURE

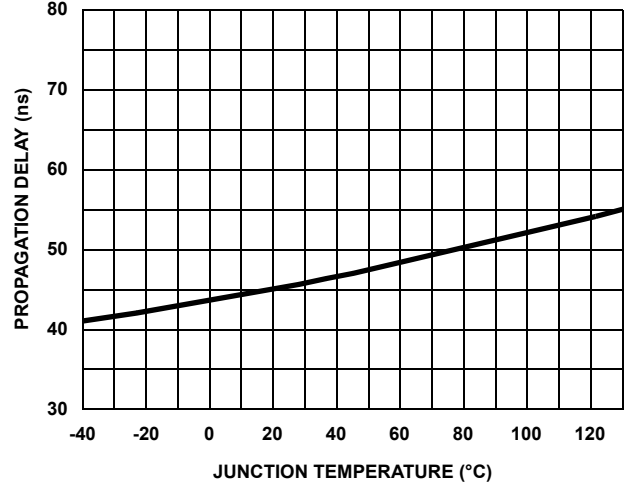

FIGURE 15. LOWER DISABLE TURN-OFF PROPAGATION DELAY T_{DISLOW} vs TEMPERATURE

Typical Performance Curves $V_{DD} = V_{CC} = V_{AHB} = V_{BHB} = 12V$, $V_{SS} = V_{ALS} = V_{BLS} = V_{AHS} = V_{BHS} = 0V$, $R_{HDEL} = R_{LDEL} = 10K$, and $T_A = +25^{\circ}C$, Unless Otherwise Specified

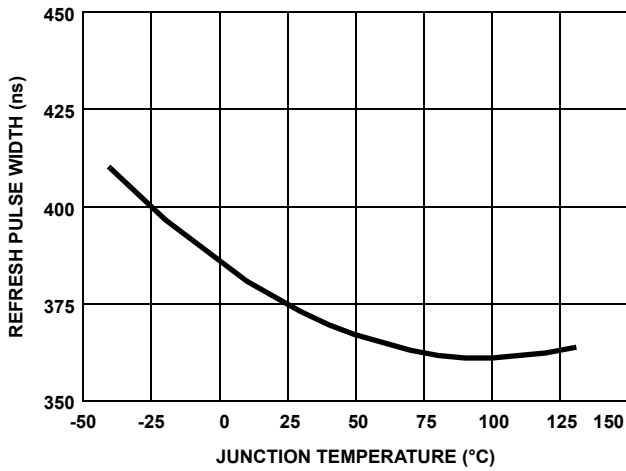

FIGURE 16. T_{REF-PW} REFRESH PULSE WIDTH vs TEMPERATURE

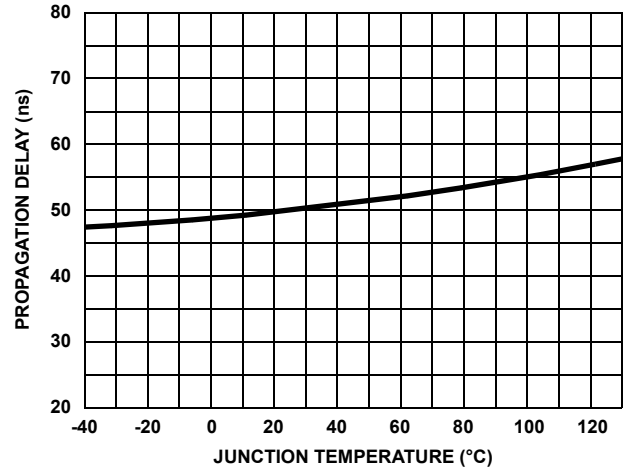

FIGURE 17. DISABLE TO LOWER ENABLE TDLPLH PROPAGATION DELAY vs TEMPERATURE

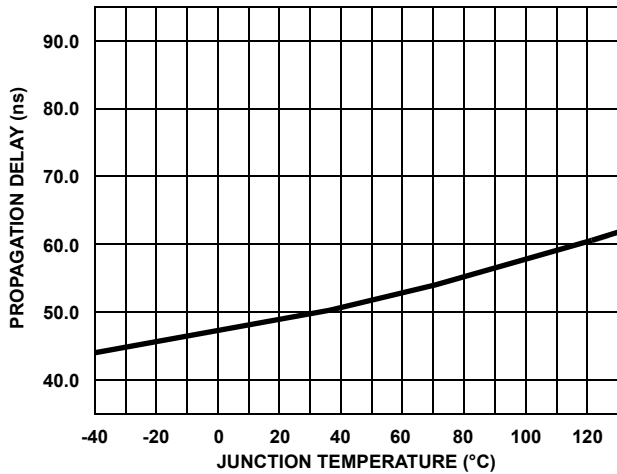

FIGURE 18. UPPER TURN-OFF PROPAGATION DELAY T_{HPLH} vs TEMPERATURE

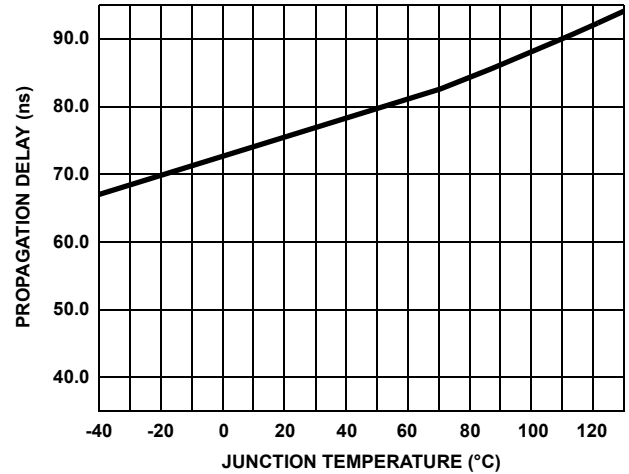

FIGURE 19. UPPER TURN-ON PROPAGATION DELAY T_{HPLH} vs TEMPERATURE

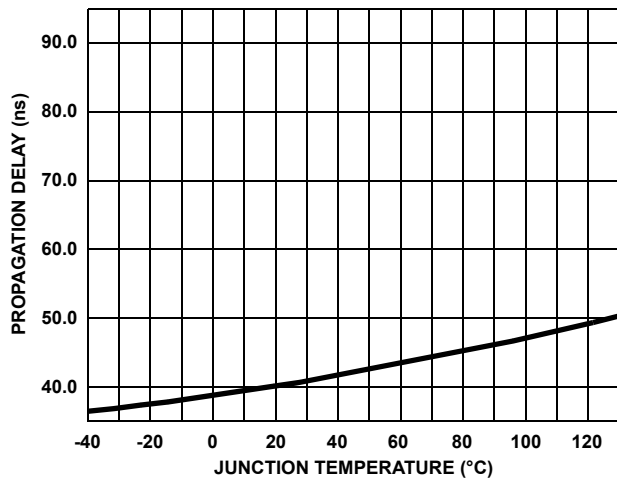

FIGURE 20. LOWER TURN-OFF PROPAGATION DELAY T_{LPHL} vs TEMPERATURE

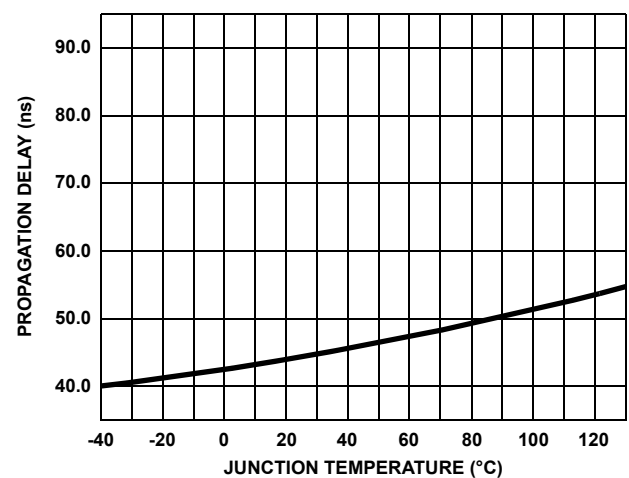

FIGURE 21. LOWER TURN-ON PROPAGATION DELAY T_{LPLH} vs TEMPERATURE

Typical Performance Curves $V_{DD} = V_{CC} = V_{AHB} = V_{BHB} = 12V$, $V_{SS} = V_{ALS} = V_{BLS} = V_{AHS} = V_{BHS} = 0V$, $R_{HDEL} = R_{LDEL} = 100K$, and $T_A = +25^\circ C$, Unless Otherwise Specified

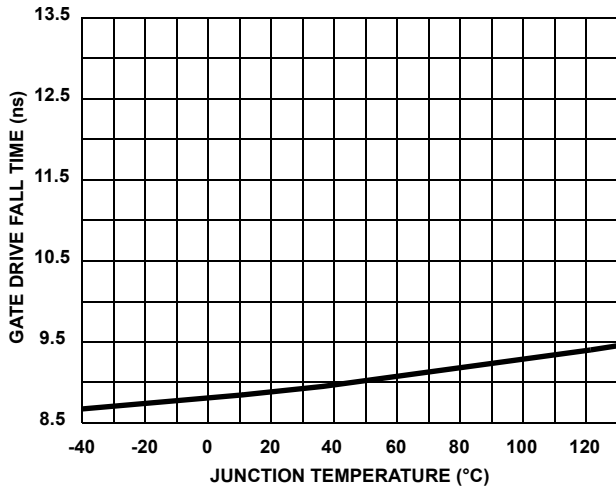

FIGURE 22. GATE DRIVE FALL TIME T_F vs TEMPERATURE

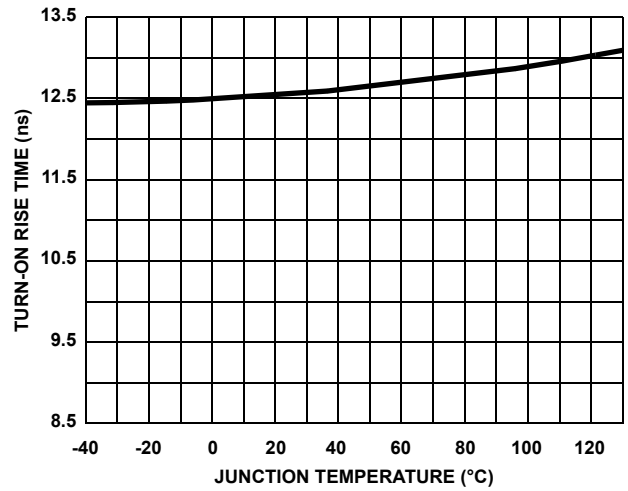

FIGURE 23. GATE DRIVE RISE TIME T_R vs TEMPERATURE

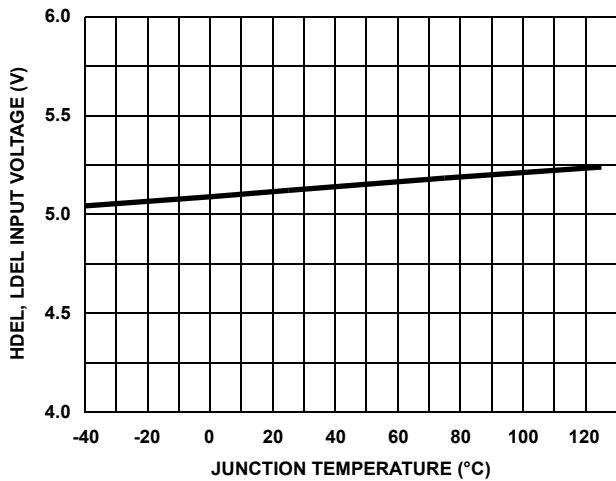

FIGURE 24. V_{LDEL} , V_{HDEL} VOLTAGE vs TEMPERATURE

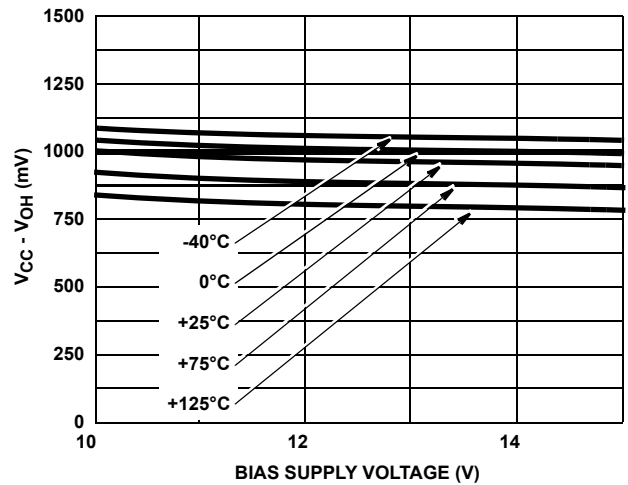

FIGURE 25. HIGH LEVEL OUTPUT VOLTAGE, $V_{CC} - V_{OH}$ vs BIAS SUPPLY AND TEMPERATURE AT $100\mu A$

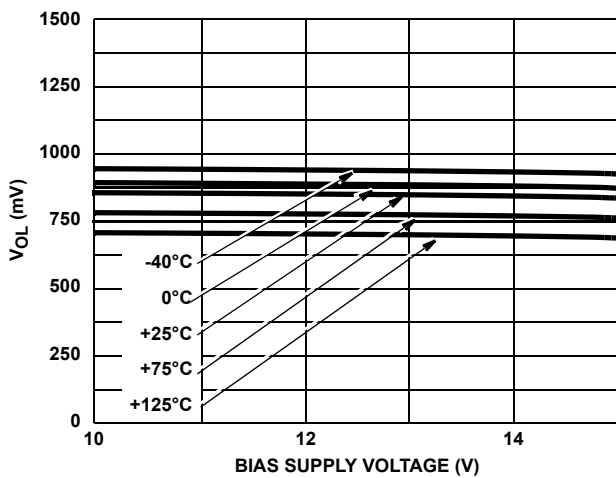

FIGURE 26. LOW LEVEL OUTPUT VOLTAGE V_{OL} vs BIAS SUPPLY AND TEMPERATURE AT $100\mu A$

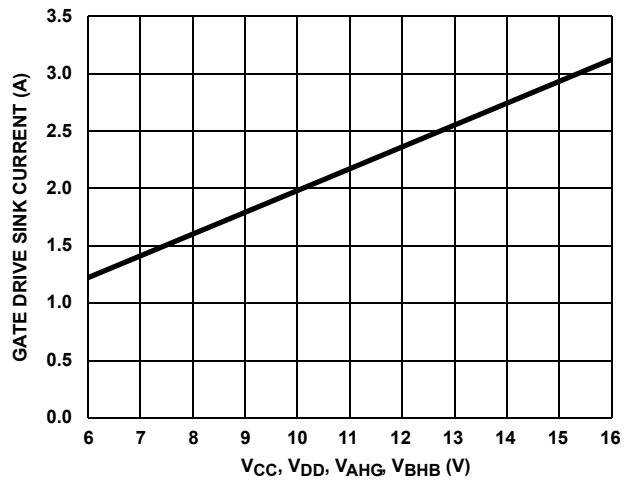

FIGURE 27. PEAK PULLDOWN CURRENT $I_{O, BIAS}$ SUPPLY VOLTAGE

Typical Performance Curves $V_{DD} = V_{CC} = V_{AHB} = V_{BHB} = 12V$, $V_{SS} = V_{ALS} = V_{BLS} = V_{AHS} = V_{BHS} = 0V$, $R_{HDEL} = R_{LDEL} = 100K$, and $T_A = +25^{\circ}C$, Unless Otherwise Specified (Continued)

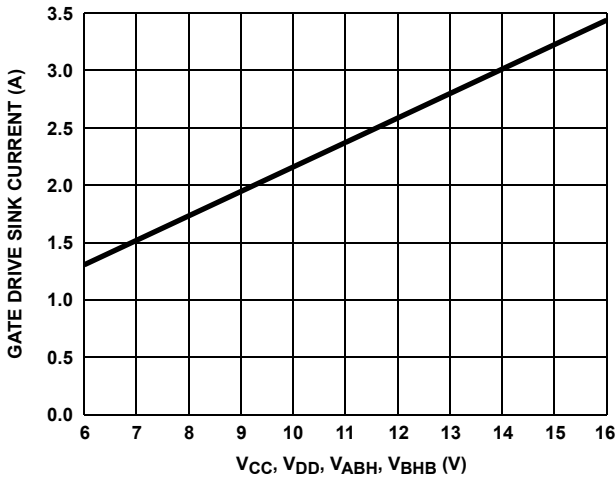

FIGURE 28. PEAK PULLUP CURRENT I_{O+} vs SUPPLY VOLTAGE

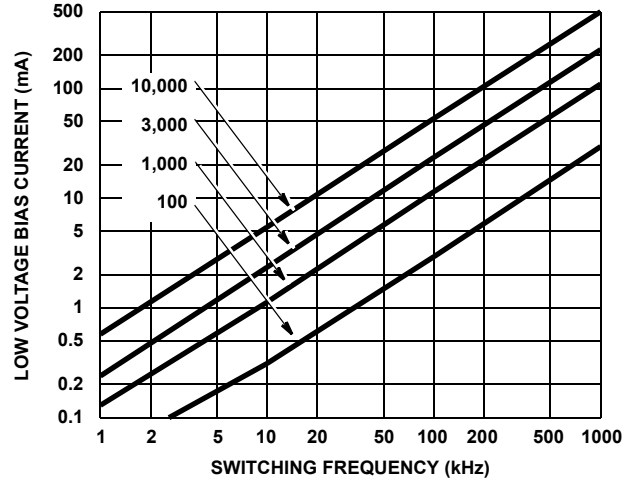

FIGURE 29. LOW VOLTAGE BIAS CURRENT I_{DD} AND I_{CC} (LESS QUIESCENT COMPONENT) vs FREQUENCY AND GATE LOAD CAPACITANCE

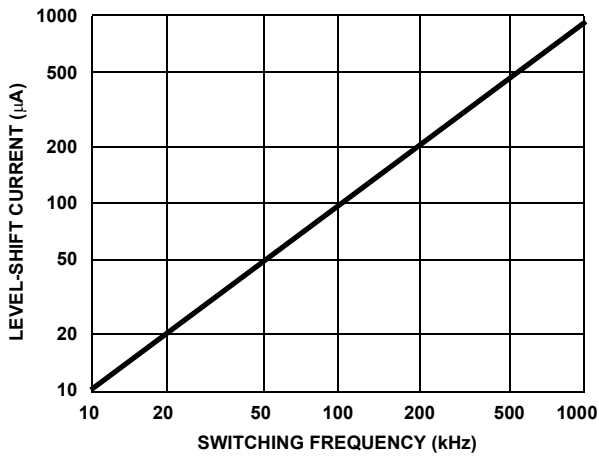

FIGURE 30. HIGH VOLTAGE LEVEL-SHIFT CURRENT vs FREQUENCY AND BUS VOLTAGE

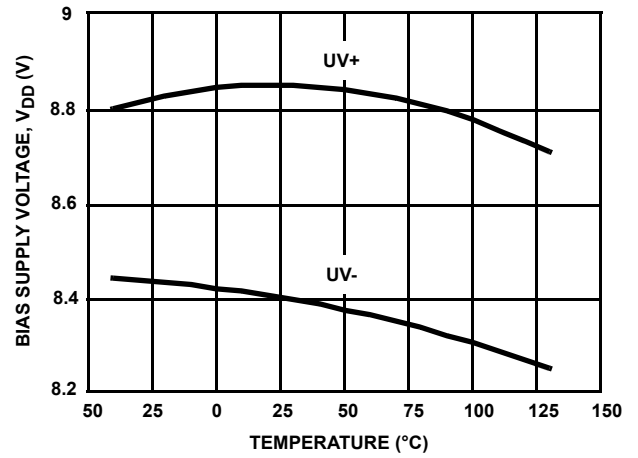

FIGURE 31. UNDERVOLTAGE LOCKOUT vs TEMPERATURE

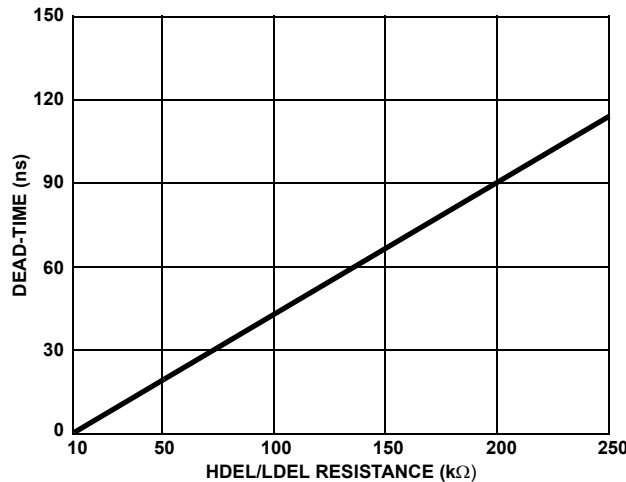

FIGURE 32. MINIMUM DEAD-TIME vs DEL RESISTANCE

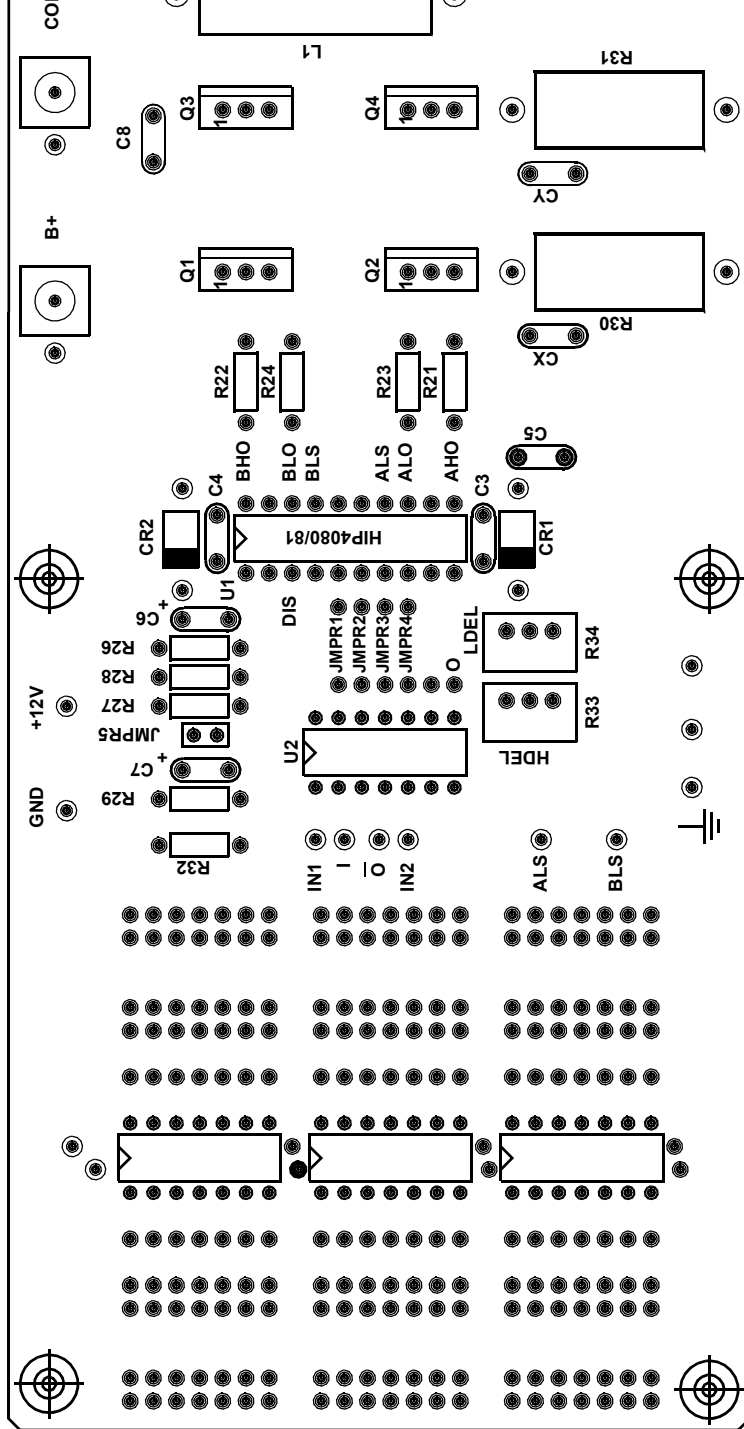
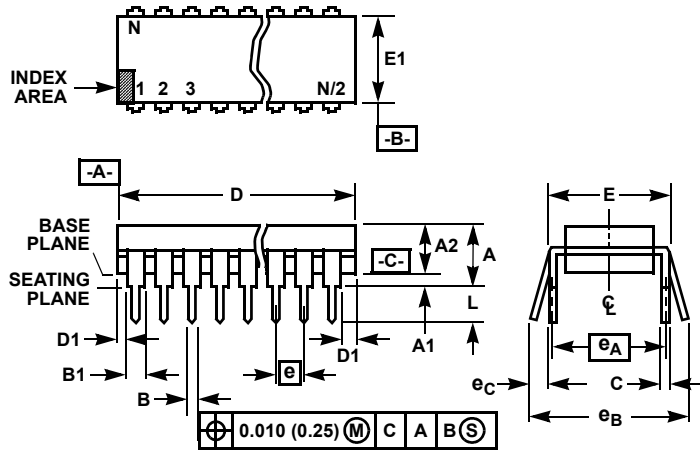

FIGURE 33. HIP4080A EVALUATION BOARD SILKSCREEN

Dual-In-Line Plastic Packages (PDIP)



NOTES:

1. Controlling Dimensions: INCH. In case of conflict between English and Metric dimensions, the inch dimensions control.
2. Dimensioning and tolerancing per ANSI Y14.5M-1982.
3. Symbols are defined in the "MO Series Symbol List" in Section 2.2 of Publication No. 95.
4. Dimensions A, A1 and L are measured with the package seated in JEDEC seating plane gauge GS-3.
5. D, D1, and E1 dimensions do not include mold flash or protrusions. Mold flash or protrusions shall not exceed 0.010 inch (0.25mm).
6. E and e_A are measured with the leads constrained to be perpendicular to datum $-C-$.
7. e_B and e_C are measured at the lead tips with the leads unconstrained. e_C must be zero or greater.
8. B1 maximum dimensions do not include dambar protrusions. Dambar protrusions shall not exceed 0.010 inch (0.25mm).
9. N is the maximum number of terminal positions.
10. Corner leads (1, N, N/2 and N/2 + 1) for E8.3, E16.3, E18.3, E28.3, E42.6 will have a B1 dimension of 0.030 - 0.045 inch (0.76 - 1.14mm).

**E20.3 (JEDEC MS-001-AD ISSUE D)
20 LEAD DUAL-IN-LINE PLASTIC PACKAGE**

SYMBOL	INCHES		MILLIMETERS		NOTES
	MIN	MAX	MIN	MAX	
A	-	0.210	-	5.33	4
A1	0.015	-	0.39	-	4
A2	0.115	0.195	2.93	4.95	-
B	0.014	0.022	0.356	0.558	-
B1	0.045	0.070	1.55	1.77	8
C	0.008	0.014	0.204	0.355	-
D	0.980	1.060	24.89	26.9	5
D1	0.005	-	0.13	-	5
E	0.300	0.325	7.62	8.25	6
E1	0.240	0.280	6.10	7.11	5
e	0.100 BSC		2.54 BSC		-
e_A	0.300 BSC		7.62 BSC		6
e_B	-	0.430	-	10.92	7
L	0.115	0.150	2.93	3.81	4
N	20		20		9

Rev. 0 12/93

Small Outline Plastic Packages (SOIC)

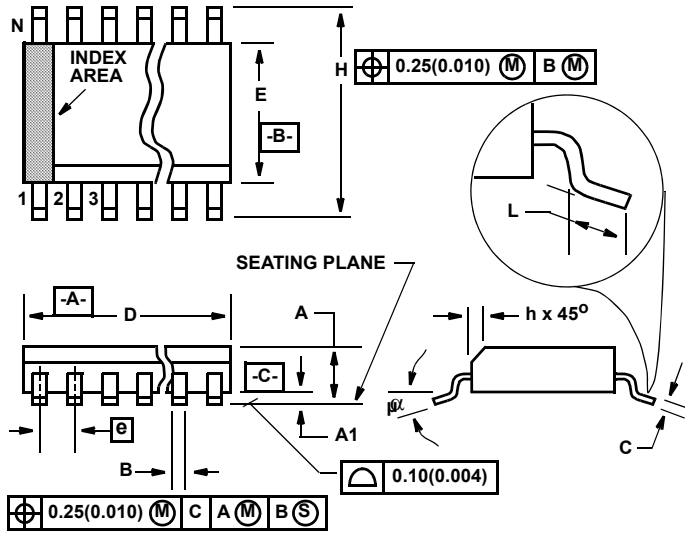

**M20.3 (JEDEC MS-013-AC ISSUE C)
20 LEAD WIDE BODY SMALL OUTLINE PLASTIC PACKAGE**

SYMBOL	INCHES		MILLIMETERS		NOTES
	MIN	MAX	MIN	MAX	
A	0.0926	0.1043	2.35	2.65	-
A1	0.0040	0.0118	0.10	0.30	-
B	0.014	0.019	0.35	0.49	9
C	0.0091	0.0125	0.23	0.32	-
D	0.4961	0.5118	12.60	13.00	3
E	0.2914	0.2992	7.40	7.60	4
e	0.050 BSC		1.27 BSC		-
H	0.394	0.419	10.00	10.65	-
h	0.010	0.029	0.25	0.75	5
L	0.016	0.050	0.40	1.27	6
N	20		20		7
α	0°	8°	0°	8°	-

Rev. 1 1/02

NOTES:

1. Symbols are defined in the "MO Series Symbol List" in Section 2.2 of Publication Number 95.
2. Dimensioning and tolerancing per ANSI Y14.5M-1982.
3. Dimension "D" does not include mold flash, protrusions or gate burrs. Mold flash, protrusion and gate burrs shall not exceed 0.15mm (0.006 inch) per side.
4. Dimension "E" does not include interlead flash or protrusions. Interlead flash and protrusions shall not exceed 0.25mm (0.010 inch) per side.
5. The chamfer on the body is optional. If it is not present, a visual index feature must be located within the crosshatched area.
6. "L" is the length of terminal for soldering to a substrate.
7. "N" is the number of terminal positions.
8. Terminal numbers are shown for reference only.
9. The lead width "B", as measured 0.36mm (0.014 inch) or greater above the seating plane, shall not exceed a maximum value of 0.61mm (0.024 inch)
10. Controlling dimension: MILLIMETER. Converted inch dimensions are not necessarily exact.

© Copyright Intersil Americas LLC 2003-2004. All Rights Reserved.
All trademarks and registered trademarks are the property of their respective owners.

For additional products, see www.intersil.com/en/products.html

Intersil products are manufactured, assembled and tested utilizing ISO9001 quality systems as noted in the quality certifications found at www.intersil.com/en/support/qualandreliability.html

Intersil products are sold by description only. Intersil may modify the circuit design and/or specifications of products at any time without notice, provided that such modification does not, in Intersil's sole judgment, affect the form, fit or function of the product. Accordingly, the reader is cautioned to verify that datasheets are current before placing orders. Information furnished by Intersil is believed to be accurate and reliable. However, no responsibility is assumed by Intersil or its subsidiaries for its use; nor for any infringements of patents or other rights of third parties which may result from its use. No license is granted by implication or otherwise under any patent or patent rights of Intersil or its subsidiaries.

For information regarding Intersil Corporation and its products, see www.intersil.com

Looking for pricing, stock, or lifecycle information?

Click below to explore more details on WIN SOURCE:

 [View HIP4080AIPZ on WIN SOURCE](#)

 [Intersil Information](#)

Optimize Your Supply Chain with WIN SOURCE Solutions

-  Global Sourcing Solution
-  Obsolete Management
-  Cost Control Management
-  Shortage Management
-  Alternative Solution
-  Excess Inventory Management