



**THE DATASHEET OF
HFW5S-2STE1LF**





FCIconnect.com

Copyright FCI.

Configuration of Documents

P/N	Documents	No.	Title	CAT.No.
HFW_S-2STAE1LF	Specification Connector dwg.	SC-HFWS03	CONNECTOR USED FOR FPC/FFC WITH 1mm CONTACT SPACING COPING WITH AUTOMATIC MOUNTING &SMT	HFW_S-2ST1LF
		JSA96464	CAT.NO.TABLE FOR 1mm SPACING SMT CONNECTOR	HFW_S-2ST_LF
		JSA96465	1mm SPACING SURFACE MOUNT FPC/FFC CONNECTOR	HFW_S-2ST_LF
		JSA96466	CAT. NO. TABLE FOR PLASTIC TAPE PACKAGED 1mm SPACING SMT CONN.	HFW_S-2ST1LF
	Cable dwg.	JSA96467	PLASTIC TAPE PACKAGED 1mm SPACING SMT CONNECTOR	HFW_S-2ST1LF
		JSA93588	RECOMMENDED CABLE	HFW_S-2ST_
		JSA93587	RECOMMENDED CABLE	HFW_S-2ST_
HFW_S-2STAE1LF	Specification Connector dwg.	SC-HFWS06	CONNECTOR USED FOR CIC WITH 1mm CONTACT SPACING COPING WITH AUTOMATIC MOUNTING &SMT	HFW_S-2STAE1LF
		JSA97359	CAT.NO.TABLE FOR 1mm SPACING SMT CONNECTOR	HFW_S-2STA_LF
		JSA97370	1mm SPACING SURFACE MOUNT FPC/FFC CONNECTOR	HFW_S-2STA_LF
		JSA97371	CAT. NO. TABLE FOR PLASTIC TAPE PACKAGED 1mm SPACING SMT CONN.	HFW_S-2STAE1LF
	Cable dwg.	JSA97372	PLASTIC TAPE PACKAGED 1mm SPACING SMT CONNECTOR	HFW_S-2STAE1LF
		JSA97373	RECOMMENDED CABLE	HFW_S-2STA_
HFW_S-2STBE1LF	Specification Connector dwg.	SC-HFWS06	CONNECTOR USED FOR CIC WITH 1mm CONTACT SPACING COPING WITH AUTOMATIC MOUNTING &SMT	HFW_S-2STBE1LF
		JSA97359	CAT.NO.TABLE FOR 1mm SPACING SMT CONNECTOR	HFW_S-2STB_LF
		JSA97360	1mm SPACING SURFACE MOUNT FPC/FFC CONNECTOR	HFW_S-2STB_LF
		JSA97361	CAT. NO. TABLE FOR PLASTIC TAPE PACKAGED 1mm SPACING SMT CONN.	HFW_S-2STBE1LF
	Cable dwg.	JSA97362	PLASTIC TAPE PACKAGED 1mm SPACING SMT CONNECTOR	HFW_S-2STBE1LF
		JSA97363	RECOMMENDED CABLE	HFW_S-2STB_
HFW_S-6STAE1LF	Specification Connector dwg.	SC-HFWS04	CONNECTOR USED FOR CIC WITH 1mm CONTACT SPACING COPING WITH AUTOMATIC MOUNTING &SMT	HFW_S-6STAE1LF
		JSA96468	CAT.NO.TABLE FOR 1mm SPACING SMT CONNECTOR	HFW_S-6ST_LF
		JSA96469	1mm SPACING SURFACE MOUNT CIC CONNECTOR	HFW_S-6ST_LF
		JSA96470	CAT. NO. TABLE FOR PLASTIC TAPE PACKAGED 1mm SPACING SMT CONN.	HFW_S-6STAE1LF
	Cable dwg.	JSA96471	PLASTIC TAPE PACKAGED 1mm SPACING SMT CONNECTOR	HFW_S-6STAE1LF
		JSA93944	RECOMMENDED CABLE	HFW_S-6ST_

mat'l. code				surface 58 / tolerance ISO 1302 / ISO 406 / ISO 1101		projection		product family 580F		CODE JP		
ltr	ecn no	dr	date	tolerances unless otherwise specified		mm		title				
A	J05-0334	H.T	6/3/05	angles	linear	scale \propto		HFW_S Documents Configuration (1mm Contact Spacing connector)				
B	J06-0435	H.T	10/26/06					dwg no		sheet 1 of 1	size	
C	J07-0481	H.T	2007-9-26					JSA96472			A4	
D	J07-0502	H.T	2007-10-10	dr	<i>[Signature]</i> 2007-10-10			type Product Customer Drawing				
				enr	<i>[Signature]</i> 2007-10-10						Rev	
				chr	<i>[Signature]</i> 2007-10-10						D	
				appd	<i>[Signature]</i> 2007-10-10						D	
sheet index	revision sheet	D	1									Rev D

form: A4

1

2

CAT. NO. & DIMENSIONS

(NOTE 3)	NO. OF CONTACTS (n)	CAT. NO.	DIMENSIONS (NOTE2)				
			A ± 0.2	B ± 0.2	C ± 0.2	D ± 0.2	E ± 0.2
	4	HFW4S-2ST__LF	7	5.14	3	—	—
	5	HFW5S-2ST__LF	8	6.14	4	—	—
	6	HFW6S-2ST__LF	9	7.14	5	—	—
	7	HFW7S-2ST__LF	10	8.14	6	—	—
	8	HFW8S-2ST__LF	11	9.14	7	—	—
	9	HFW9S-2ST__LF	12	10.14	8	0.35	7.3
	10	HFW10S-2ST__LF	13	11.14	9	0.35	8.3
	11	HFW11S-2ST__LF	14	12.14	10	1.35	7.3
	12	HFW12S-2ST__LF	15	13.14	11	1.35	8.3
	13	HFW13S-2ST__LF	16	14.14	12	2.35	7.3
	14	HFW14S-2ST__LF	17	15.14	13	2.35	8.3
	15	HFW15S-2ST__LF	18	16.14	14	3.35	7.3
	16	HFW16S-2ST__LF	19	17.14	15	3.35	8.3
	17	HFW17S-2ST__LF	20	18.14	16	4.35	7.3
	18	HFW18S-2ST__LF	21	19.14	17	4.35	8.3
	19	HFW19S-2ST__LF	22	20.14	18	5.35	7.3
	20	HFW20S-2ST__LF	23	21.14	19	5.35	8.3
	21	HFW21S-2ST__LF	24	22.14	20	6.35	7.3
	22	HFW22S-2ST__LF	25	23.14	21	6.35	8.3
	23	HFW23S-2ST__LF	26	24.14	22	7.35	7.3
	24	HFW24S-2ST__LF	27	25.14	23	7.35	8.3
	25	HFW25S-2ST__LF	28	26.14	24	8.35	7.3
	26	HFW26S-2ST__LF	29	27.14	25	8.35	8.3
	27	HFW27S-2ST__LF	30	28.14	26	9.35	7.3
	28	HFW28S-2ST__LF	31	29.14	27	9.35	8.3
	29	HFW29S-2ST__LF	32	30.14	28	10.35	7.3
	30	HFW30S-2ST__LF	33	31.14	29	10.35	8.3
*	31	HFW31S-2ST__LF	34	32.14	30	11.35	7.3
	32	HFW32S-2ST__LF	35	33.14	31	11.35	8.3
*	33	HFW33S-2ST__LF	36	34.14	32	12.35	7.3

CAT. NO.

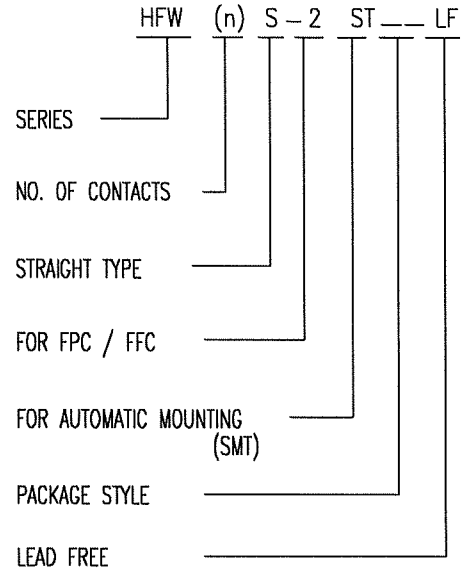

NOTES

1. THIS PRODUCT IS THE CONNECTOR DSIGNED TO TERMINATE FPC/FFC AND COPEs WITH AUTOMATIC MOUNTING (SMT).
2. SEE PART DRAWINGS FOR DIMENSIONS A~E.
3. PLEASE CONSULT US IN CASE OF USING PARTS WITH * MARK.



FCIconnect.com

Copyright FCI.

mat'l. code				surface 58 / tolerance ISO 1302 ✓ / ISO 406 / ISO 1101		projection		product family 580F		CODE JP	
ltr	ecn no	dr	date	tolerances unless otherwise specified				title CAT NO. TABLE FOR 1mm SPACING SMT CONNECTOR (CAT.No.HFW__S-2ST__LF)			
A	J05-0334	H.T	6/3/05	angles	linear	mm		FCI sheet 1 of 1 size A4 JSA 96464 type Product Customer Drawing			
B	J06-0435	H.T	10/26/06	dr		scale \times					
				enr							
				chr							
				appd				sheet 1 of 1 size A4			
sheet index	revision	B	1	Rev. B							

SC-HFWS03 JSA96465,96466,96467,93588,93587 form: A4

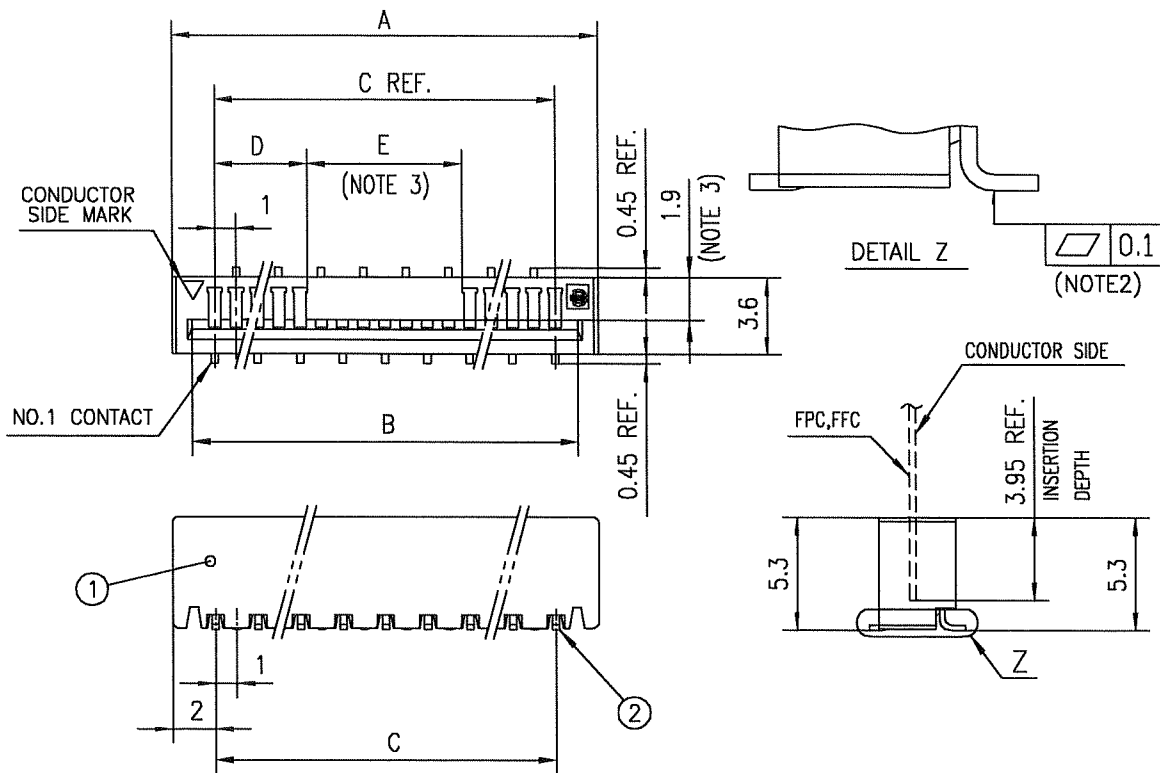

PT. NO.	PARTS NAME	MATERIAL	Q'TY	NOTE
1	HOUSING	PA6T RESIN GLASS REINFORCED (UL94V-0)	1	COLOR : BLACK
2	CONTACT	PHOSPHOR BRONZE	n	Ni UNDER Sn PLATING (LEAD FREE)

n : NO. OF CONTACTS

RECOMMENDED PC BOARD LAYOUT
(COMPONENT SIDE)

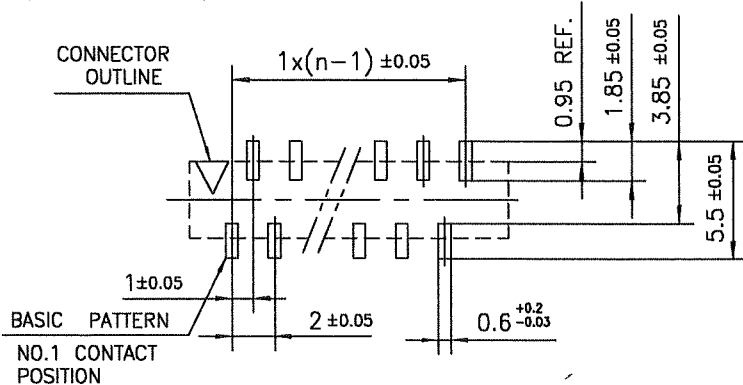

NOTES

- THIS PRODUCT IS THE CONNECTOR DESIGNED TO TERMINATE FPC/FFC AND COPES WITH AUTOMATIC MOUNTING (SMT).
- FLATNESS OF CONTACT TERMINAL MUST BE WITHIN TOLERANCE IN Z PORTION DETAILED DRAWING.
- THIS DIMENSION IS SPACE FOR THE NOZZLE OF MOUNTER.
- THIS PRODUCT MEETS EUROPEAN UNION DIRECTIVES AND OTHER COUNTRY REGULATIONS AS DESCRIBED IN GS-22-008
- THE HOUSING WILL WITHSTAND EXPOSURE TO 260°C PEAK TEMPERATURE FOR 10 SECONDS IN A REFLOW SOLDERING OVEN.

mat'l. code				surface 58 ISO 1302	tolerance ISO 406 ISO 1101	projection 	product family 580F	CODE JP
ltr	ecn no	dr	date	tolerances unless otherwise specified		mm	title 1mm SPACING SURFACE MOUNT FPC/FFC CONNECTOR (CAT.No.HFW__S-2ST__LF)	
A	J05-0334	H.T	6/3/'05	angles	linear		scale \times	dwg no JSA 96465
B	J05-0731	H.T	10/28/'05			FCI	sheet 1 of 1 size A4	
C	J06-0435	H.T	10/26/'06				type Product Customer Drawing	
sheet index	revision sheet	C	1					Rev. c

SC-HFWS03 JSA96464
form: A4

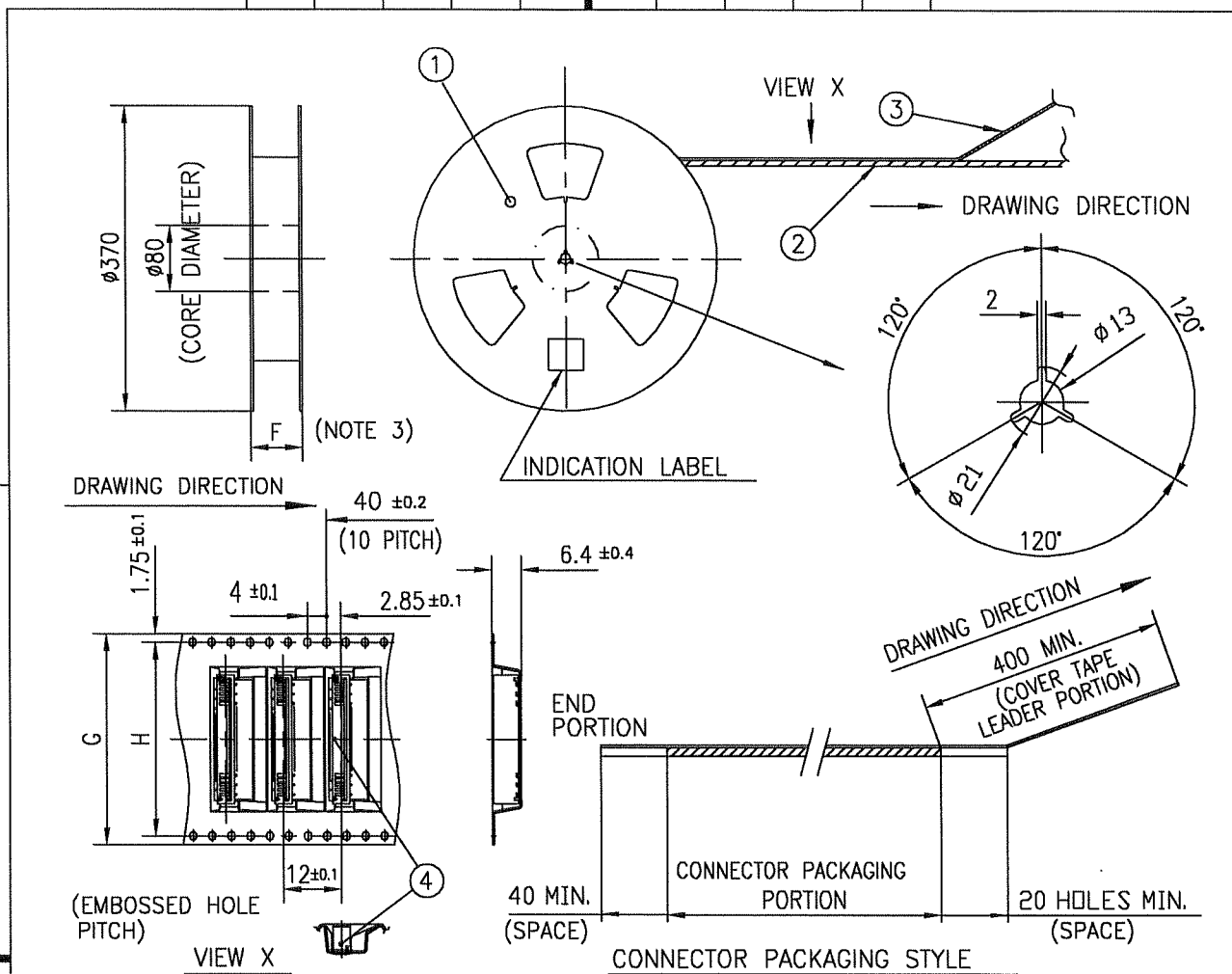

PT. NO.	PARTS NAME	CAT. NO.	MATERIAL	Q'TY	NOTE
1	REEL	_____	CARDBOARD	1	COLOR:GRAY
2	PLASTIC (EMBOSSED) TAPE	_____	PET	_____	COLOR:TRANSPARENCY
3	COVER	_____	POLYESTER	_____	COLOR:TRANSPARENCY
4	CONNECTOR	HFW__S-2ST__LF	SEE ATTACHED DWG.	1000	_____

NOTES

- THIS IS PLASTIC TAPE PACKAGED CONNECTOR USED FOR FPC/FFC AND COPES WITH AUTOMATIC MOUNTING (SMT).
- SEE JIS C 0806 (PACKING OF ELECTRONIC COMPONENTS ON CONTINUOUS TAPES (SURFACE MOUNTING DEVICES)) FOR SHAPE AND DIMENSIONS OF PLASTIC (EMBOSSED) TAPE AND REEL.
- F DIMENSION IS PORTION OF THE CORE.

mat'l. code		surface 58 / tolerance ISO 1302 ✓ / ISO 406 / ISO 1101		projection		product family 580F		CODE JP	
ltr	ecn no	dr	date	tolerances unless otherwise specified		title		PLASTIC TAPE PACKAGED 1mm SPACING SMT CONNECTOR (CAT.No.HFW__S-2STE1LF)	
A	J05-0334	H.T	6/3/05	angles	linear	mm			
B	J06-0435	H.T	10/26/06	±5'		scale X			
		dr	<i>H. Shoji</i> 10/26/06			dwg no		sheet 1 of 1 size	
		enr	<i>K. Shoji</i> 10/26/06			JSA 96467		A4	
		chr	<i>K. Shoji</i> 10/26/06			type		Product Customer Drawing	
		app	<i>S. Madams</i> 10/27/06						
sheet index	revision	B						Rev. B	
	sheet	1							

SC-HFWS03 JSA96464 96466 form: A4

RECOMMENDED CABLE (FFC)

n : NO. OF CONDUCTOR

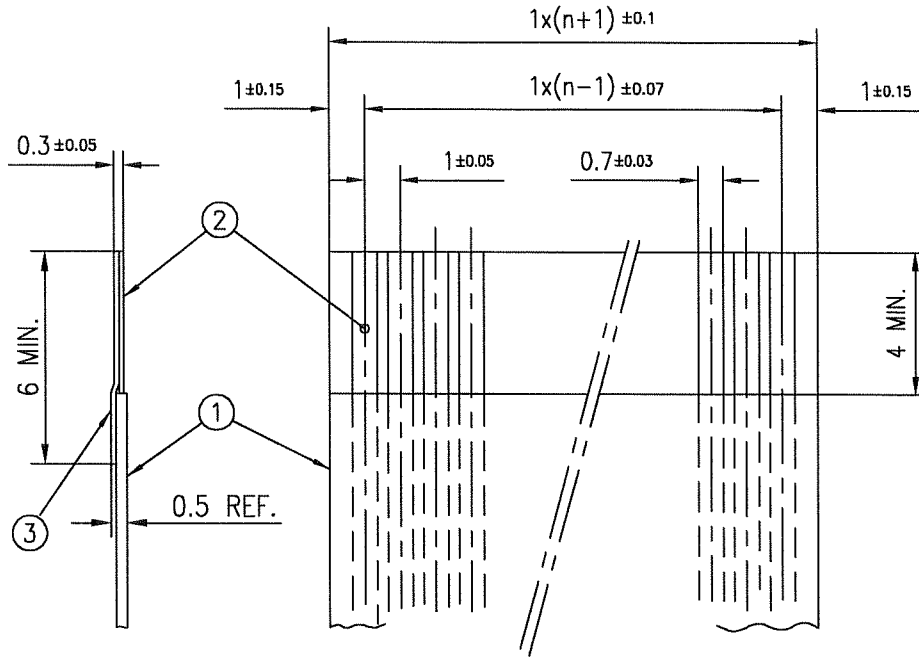

PT. NO.	DESCRIPTION	MATERIAL	NOTE
1	INSULATOR	FLAME RESISTING POLYESTER OR EQUIVALENT	_____
2	CONDUCTOR	COPPER FOIL	PLATING: TIN OR SOLDER 1µm MIN.
3	SUPPORTING TAPE	FLAME RESISTING POLYESTER OR EQUIVALENT	_____

NOTES

1. NO BURR AT EACH PORTION.
2. NO PEELING IN COMMON USE.

mat'l. code				surface 58 ISO 1302	tolerance ISO 406 ISO 1101	projection 	product family 580F	CODE JP
ltr	ecn no	dr	date	tolerances unless otherwise specified		mm 	title RECOMMENDED CABLE (CAT.No.HFW__S-2ST__)	
AA	J04-0334	H.T	Oct.13,'04	angles	linear			
AB	J06-0435	H.T	10/26/'06			scale \times	dwg no JSA 93588	
				dr	<i>K. Hoshino</i> 10/26/06		sheet 1 of 1 size A4	
				enr	<i>K. Hoshino</i> 10/26/06		type Product Customer Drawing	
				chr	<i>R. Shoyji</i> 10/24/06			
				appd	<i>S. Madam</i> 10/27/06			
sheet index	revision sheet	AB	1					Rev. AB

RECOMMENDED CABLE (FPC)

n : NO. OF CONDUCTORS

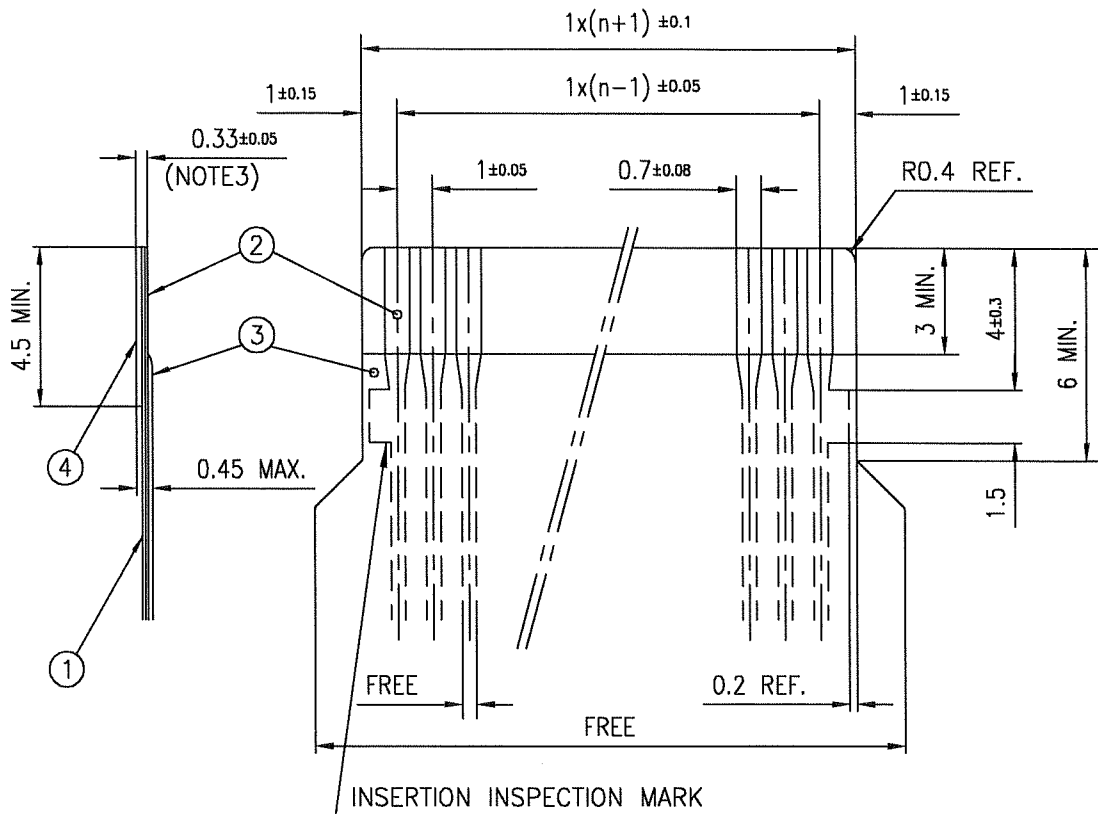

PT. NO.	DISCRIPTION	MATERIAL	THICKNESS (μm)
1	BASE FILM	POLYIMIDE OR POLYESTER OR EQUIVALENT	25
2	CONDUCTOR	COPPER FOIL(PLATING : SOLDER 1μm MIN.)	35
3	OVERLAY	POLYIMIDE OR POLYESTER OR EQUIVALENT	—
4	SUPPORTING TAPE	POLYESTER OR POLYIMIDE OR EQUIVALENT	188



NOTES

1. NO BURR AT EACH PORTION.
2. NO PEELING IN COMMON USE.
3. TOTAL THICKNESS LIMIT OF EACH MATERIAL (INCLUDING ADHESIVE AGENT) IS SPECIFIED.

mat'l. code				surface 58 / tolerance ISO 1302 ✓ / ISO 406 / ISO 1101		projection		product family 580F		CODE JP	
litr ecn no dr date				tolerances unless otherwise specified		mm		title			
AA J04-0334 H.T Oct.13,'04				angles linear		mm		RECOMMENDED CABLE (CAT.No.HFW__S-2ST__)			
AB J06-0435 H.T 10/26/'06						scale X		dwg no sheet 1 of 1 size			
				dr <i>H. Hoshino</i> 10/26/06				JSA 93587 A4			
				enr <i>H. Hoshino</i> 10/26/06				type Product Customer Drawing			
				chr <i>R. Shouji</i> 10/26/06							
				appd <i>S. Hoshino</i> 10/27/06							
sheet index		revision sheet 1		AB						Rev. AB	

Looking for pricing, stock, or lifecycle information?

Click below to explore more details on WIN SOURCE:

-  [View HFW5S-2STE1LF on WIN SOURCE](#)
-  [Amphenol FCI Information](#)

Optimize Your Supply Chain with WIN SOURCE Solutions

-  Global Sourcing Solution
-  Obsolete Management
-  Cost Control Management
-  Shortage Management
-  Alternative Solution
-  Excess Inventory Management