



**THE DATASHEET OF  
HFCN-1100+**





CERAMIC

# High Pass Filter

## HFCN-1100+

Mini-Circuits

50Ω 1500 to 3900 MHz

### THE BIG DEAL

- Low cost
- Small size
- 7 sections
- Temperature stable
- DC block in/out, breakdown voltage, 1kV typ.
- Excellent power handling, 7W
- Hermetically sealed

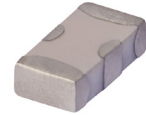

Generic photo used for illustration purposes only

CASE STYLE: FV1206

#### +RoHS Compliant

The +Suffix identifies RoHS Compliance. See our web site for RoHS Compliance methodologies and qualifications

### APPLICATIONS

- Sub-harmonic rejection
- Transmitters/receivers
- Lab use

### PRODUCT OVERVIEW

The HFCN-1100+ LTCC High Pass Filter is constructed with 12 layers in order to achieve a miniature size and high repeatability of performance. Wrap-around terminations minimize variations in performance due to parasitics. Covering 1500-3900 MHz, these units offer low insertion loss and good rejection.

### KEY FEATURES

Feature	Advantages
Small Size (3.20mm x1.6 mm)	Allows for high layout density of circuit boards, while minimizing affects of parasitics.
Rejection peaks at harmonic frequencies	Provides good rejection of signals at harmonic frequencies, for improved system performance.
Wrap around termination	Provides excellent solderability and easy visual inspection capability.
LTCC construction	Provides a rugged package that is well suited for tough environments including high humidity and high temperature extremes.

REV. B  
ECO-011980  
HFCN-1100+  
AD/CP/AM  
220221





CERAMIC

# High Pass Filter

## HFCN-1100+

### ELECTRICAL SPECIFICATIONS<sup>1,2</sup> AT 25°C

Parameter	F#	Frequency (MHz)	Min.	Typ.	Max.	Units
Stop Band	DC-F1	DC-530	40	—	—	dB
	F1-F2	DC-700	20	—	—	
	Freq. Cut-Off	F3	1100	—	3.0	dB
	VSWR	DC-F2	DC-700	—	20	:1
Pass Band	F4-F7	1500-3900	—	—	2.0	dB
	F5-F6	1400-3500	—	—	1.3	dB
	VSWR	F4-F7	1500-3900	—	1.5	:1

1. In Application where DC voltage is present at either input or output ports, coupling capacitors are required.

2. Measured on Mini-Circuits Characterization Test Board TB-270.

### MAXIMUM RATINGS

Parameter	Ratings
Operating temperature	-55°C to +100°C
Storage temperature	-55°C to +100°C
RF Power Input <sup>3</sup>	7W max.at 25°C

3. Passband rating, derate linearly to 3W at 100°C ambient. Permanent damage may occur if any of these limits are exceeded.

### TYPICAL FREQUENCY RESPONSE

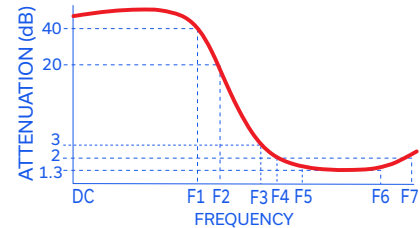

### FUNCTIONAL SCHEMATIC

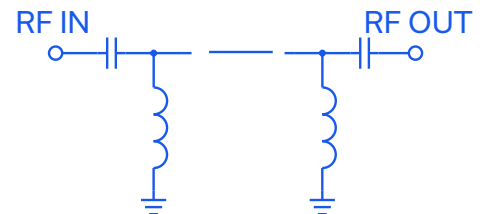



CERAMIC

# High Pass Filter

## HFCN-1100+

### PIN CONNECTIONS

RF IN	1
RF OUT	3
GROUND	2,4

PRODUCT MARKING: N/A

DEMO BOARD MCL P/N: TB-270  
SUGGESTED PCB LAYOUT (PL-137)

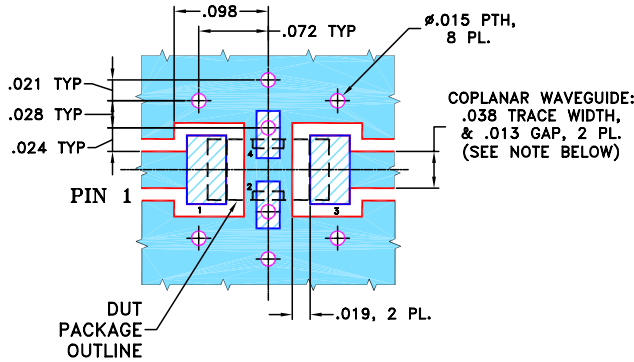

- NOTES:**
1. COPLANAR WAVEGUIDE PARAMETERS ARE SHOWN FOR ROGERS RO4350B WITH THICKNESS .020" ± .0015". COPPER: 1/2 OZ. EACH SIDE. FOR OTHER MATERIALS TRACE WIDTH & GAP MAY NEED TO BE MODIFIED.
  2. BOTTOM SIDE OF THE PCB IS CONTINUOUS GROUND PLANE.

- DENOTES PCB COPPER LAYOUT WITH SMOBC (SOLDER MASK OVER BARE COPPER)
- DENOTES COPPER LAND PATTERN FREE OF SOLDER MASK

### OUTLINE DRAWING

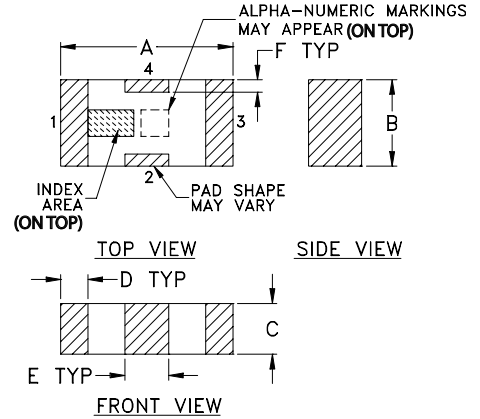

### PCB Land Pattern

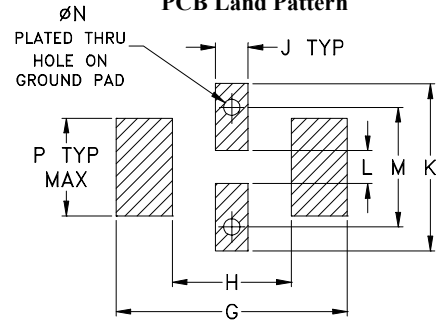

Suggested Layout,  
Tolerance to be within ±.002

### OUTLINE DIMENSIONS (Inches / mm)

A	B	C	D	E	F	G	H	J	K	L	M	N	P	wt
.126	.063	.037	.020	.032	.009	.169	.087	.024	.122	.024	.087	.012	.071	grams
3.20	1.60	0.94	0.51	0.81	0.23	4.29	2.21	0.61	3.10	0.61	2.21	0.30	1.80	.020

**TAPE & REEL INFORMATION: F71**



CERAMIC

# High Pass Filter

## HFCN-1100+

Mini-Circuits

### TYPICAL PERFORMANCE DATA AT 25°C

Frequency (MHz)	Insertion Loss (dB)	VSWR (:1)
10.0	94.10	>1000
500.0	66.25	96.51
700.0	37.65	48.26
1100.0	2.32	2.11
1380.0	0.70	1.03
1560.0	0.64	1.30
2100.0	0.65	1.60
3420.0	0.44	1.33
3520.0	0.50	1.43
3930.0	0.85	1.91

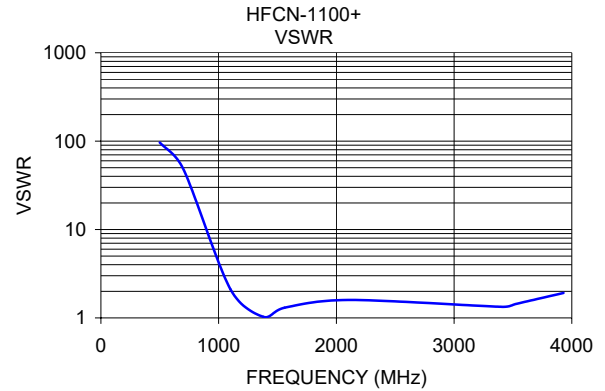
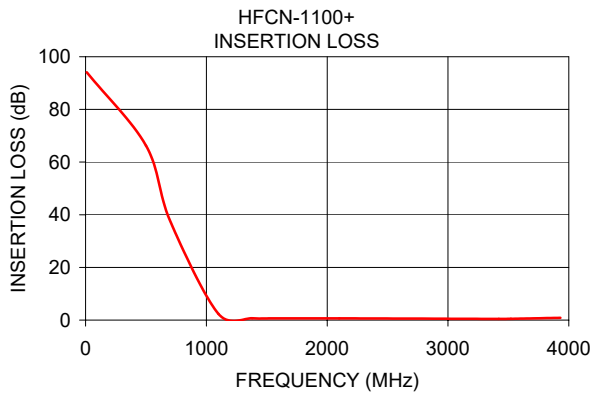

#### NOTES

- A. Performance and quality attributes and conditions not expressly stated in this specification document are intended to be excluded and do not form a part of this specification document.
- B. Electrical specifications and performance data contained in this specification document are based on Mini-Circuit's applicable established test performance criteria and measurement instructions.
- C. The parts covered by this specification document are subject to Mini-Circuits standard limited warranty and terms and conditions (collectively, "Standard Terms"); Purchasers of this part are entitled to the rights and benefits contained therein. For a full statement of the standard. Terms and the exclusive rights and remedies thereunder, please visit Mini-Circuits' website at [www.minicircuits.com/MCLStore/terms.jsp](http://www.minicircuits.com/MCLStore/terms.jsp)



## Looking for pricing, stock, or lifecycle information?

Click below to explore more details on WIN SOURCE:

 [View HFCN-1100+](#) on WIN SOURCE

 [Mini-Circuits](#) Information

## Optimize Your Supply Chain with WIN SOURCE Solutions

-  Global Sourcing Solution
-  Obsolete Management
-  Cost Control Management
-  Shortage Management
-  Alternative Solution
-  Excess Inventory Management