



THE DATASHEET OF HFA75MC40C



HFA75MC40C

Ultrafast, Soft Recovery Diode

Features

- Reduced RFI and EMI
- Reduced Snubbing
- Extensive Characterization of Recovery Parameters

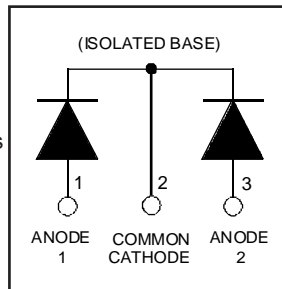

$V_R = 400V$
$V_F(\text{typ.})^{\textcircled{3}} = 1V$
$I_{F(AV)} = 75A$
$Q_{rr}(\text{typ.}) = 200nC$
$I_{RRM}(\text{typ.}) = 6A$
$t_{rr}(\text{typ.}) = 30ns$
$di_{(rec)M}/dt(\text{typ.})^{\textcircled{3}} = 190A/\mu s$

Description

HEXFRED™ diodes are optimized to reduce losses and EMI/RFI in high frequency power conditioning systems. An extensive characterization of the recovery behavior for different values of current, temperature and di/dt simplifies the calculations of losses in the operating conditions. The softness of the recovery eliminates the need for a snubber in most applications. These devices are ideally suited for power converters, motors drives and other applications where switching losses are significant portion of the total losses.

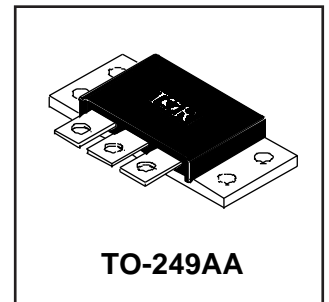

Absolute Maximum Ratings (per Leg)

	Parameter	Max.	Units
V_R	Cathode-to-Anode Voltage	400	V
$I_F @ T_C = 25^\circ C$	Continuous Forward Current	75	A
$I_F @ T_C = 100^\circ C$	Continuous Forward Current	36	
I_{FSM}	Single Pulse Forward Current $\textcircled{1}$	300	
I_{AS}	Maximum Single Pulse Avalanche Current $\textcircled{2}$	5.0	mJ
E_{AS}	Non-Repetitive Avalanche Energy $\textcircled{2}$	1.4	
$P_D @ T_C = 25^\circ C$	Maximum Power Dissipation	125	W
$P_D @ T_C = 100^\circ C$	Maximum Power Dissipation	50	
T_J	Operating Junction and	-55 to +150	$^\circ C$
T_{STG}	Storage Temperature Range		
	Soldering Temperature, for 10 sec.	300 (0.063 in. (1.6mm) from case)	

Thermal - Mechanical Characteristics

	Parameter	Min.	Typ.	Max.	Units
$R_{\theta JC}$	Junction-to-Case, Single Leg Conducting	----	----	1.0	$^\circ C/W$
	Junction-to-Case, Both Legs Conducting	----	----	0.50	K/W
$R_{\theta CS}$	Case-to-Sink, Flat, Greased Surface	----	0.10	----	
Wt	Weight	----	58 (2.0)	----	g (oz)
	Mounting Torque	35 (4.0)	----	50 (5.7)	lbf·in (N·m)

Note: $\textcircled{1}$ Limited by junction temperature
 $\textcircled{2}$ L = 100 μ H, duty cycle limited by max T_J
 $\textcircled{3}$ 125 $^\circ C$

HFA75MC40C

International
IOR Rectifier

Electrical Characteristics (per Leg) @ $T_J = 25^\circ\text{C}$ (unless otherwise specified)

	Parameter	Min.	Typ.	Max.	Units	Test Conditions
V_{BR}	Cathode Anode Breakdown Voltage	400	—	—	V	$I_R = 100\mu\text{A}$
V_{FM}	Max Forward Voltage	—	1.1	1.3	V	$I_F = 35\text{A}$
		—	1.3	1.5		$I_F = 75\text{A}$ See Fig. 1
		—	1.0	1.2		$I_F = 35\text{A}, T_J = 125^\circ\text{C}$
I_{RM}	Max Reverse Leakage Current	—	0.50	3.0	μA	$V_R = V_R$ Rated See Fig. 2
		—	0.75	4.0	mA	$T_J = 125^\circ\text{C}, V_R = 320\text{V}$
C_T	Junction Capacitance	—	90	125	pF	$V_R = 200\text{V}$ See Fig. 3
L_S	Series Inductance	—	8.0	—	nH	From terminal hole to terminal hole

Dynamic Recovery Characteristics (per Leg) @ $T_J = 25^\circ\text{C}$ (unless otherwise specified)

	Parameter	Min.	Typ.	Max.	Units	Test Conditions
t_{rr}	Reverse Recovery Time	—	30	—	ns	$I_F = 1.0\text{A}, di/dt = 200\text{A}/\mu\text{s}, V_R = 30\text{V}$
t_{rr1}		—	67	100		$T_J = 25^\circ\text{C}$ See Fig.
t_{rr2}		—	110	170		$T_J = 125^\circ\text{C}$ 5
I_{RRM1}	Peak Recovery Current	—	6.0	11	A	$T_J = 25^\circ\text{C}$ See Fig.
		—	9.0	16		$T_J = 125^\circ\text{C}$ 6
I_{RRM2}		—	—	—		$V_R = 200\text{V}$
Q_{rr1}	Reverse Recovery Charge	—	200	540	nC	$T_J = 25^\circ\text{C}$ See Fig.
Q_{rr2}		—	500	1300		$T_J = 125^\circ\text{C}$ 7
$di_{(rec)M}/dt1$	Peak Rate of Fall of Recovery Current During t_b	—	240	—	$\text{A}/\mu\text{s}$	$T_J = 25^\circ\text{C}$ See Fig.
$di_{(rec)M}/dt2$		—	190	—		$T_J = 125^\circ\text{C}$ 8

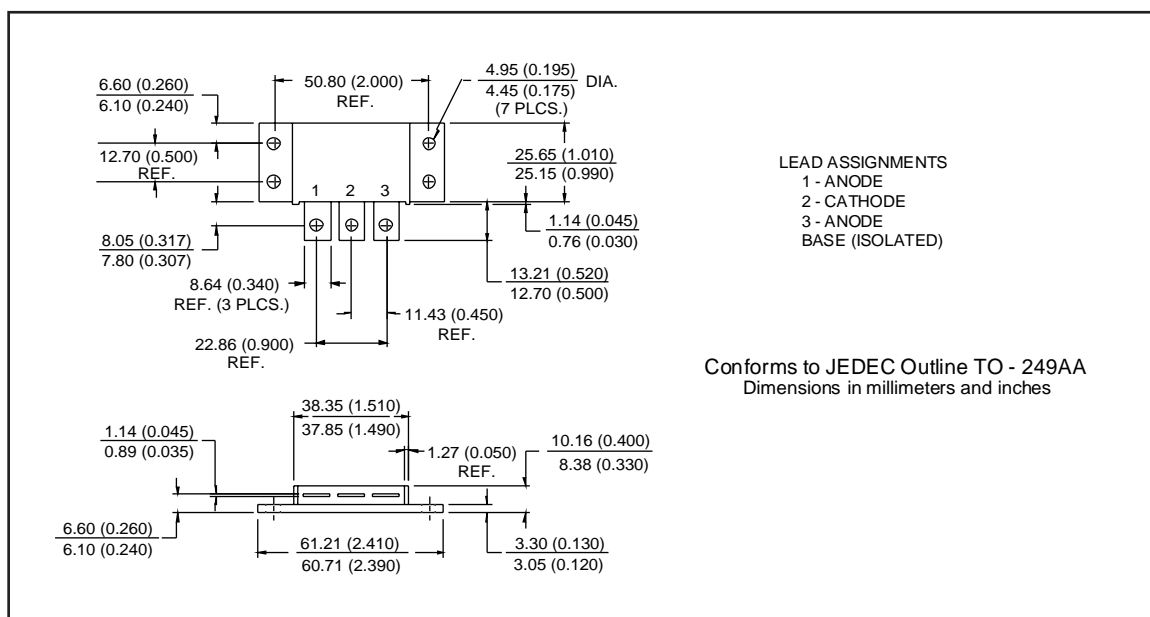

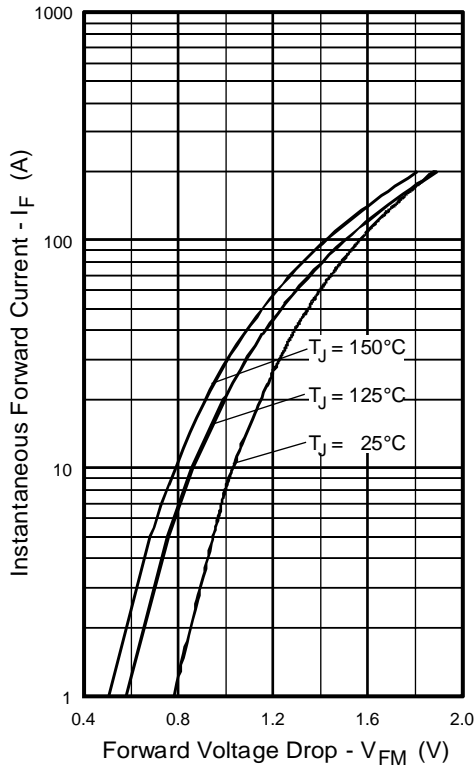

Fig. 1 - Maximum Forward Voltage Drop vs. Instantaneous Forward Current, (per Leg)

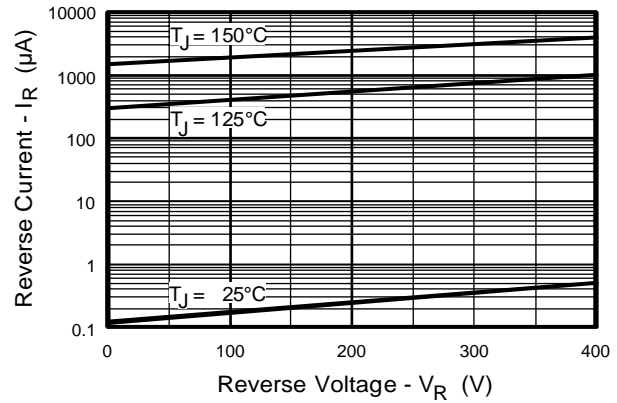

Fig. 2 - Typical Reverse Current vs. Reverse Voltage, (per Leg)

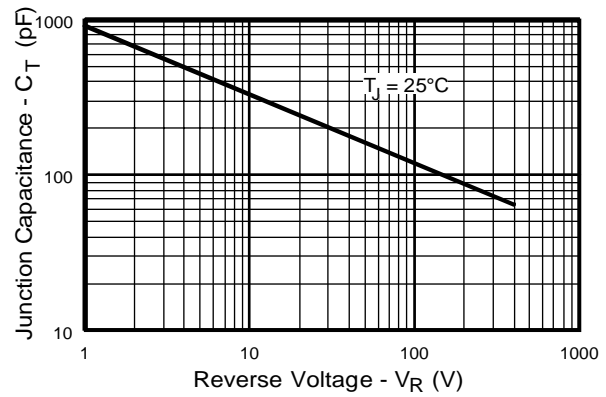

Fig. 3 - Typical Junction Capacitance vs. Reverse Voltage, (per Leg)

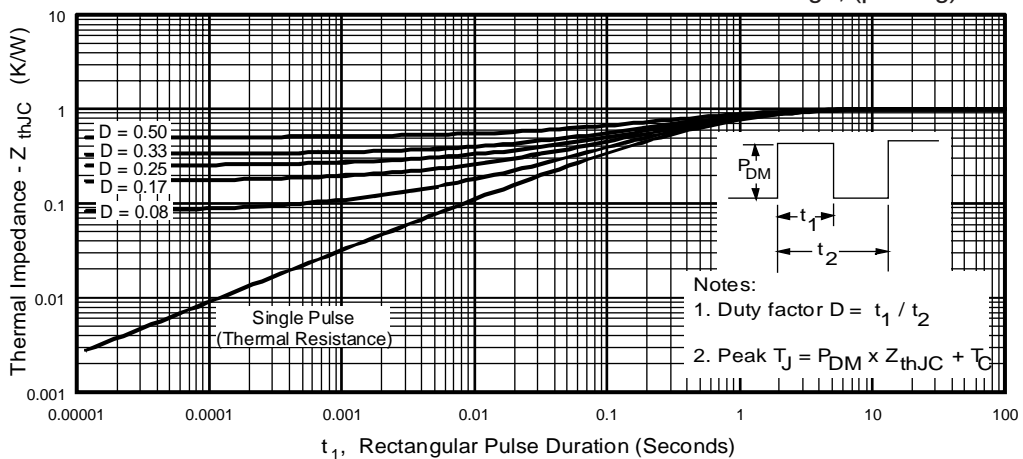

Fig. 4 - Maximum Thermal Impedance Z_{thJC} Characteristics, (per Leg)

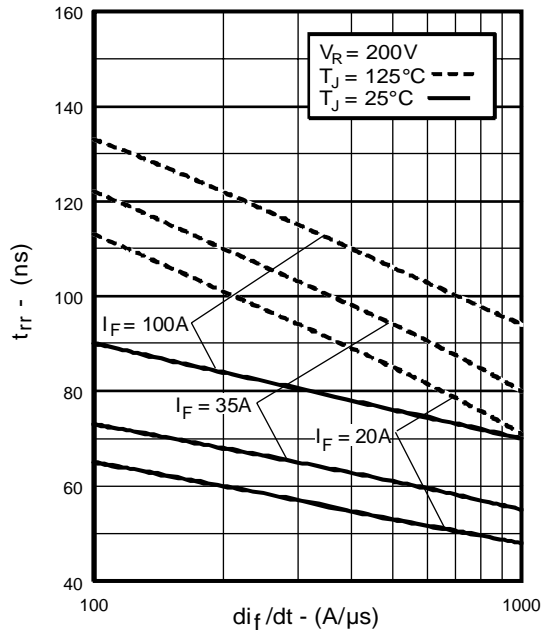

Fig. 5 - Typical Reverse Recovery vs. di_f/dt , (per Leg)

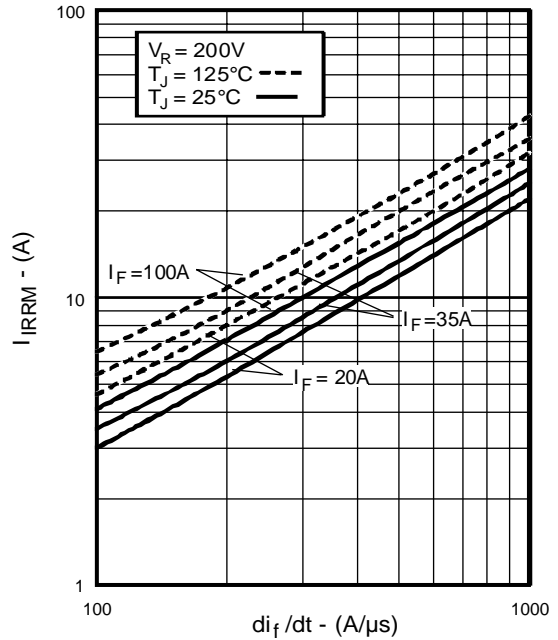

Fig. 6 - Typical Recovery Current vs. di_f/dt , (per Leg)

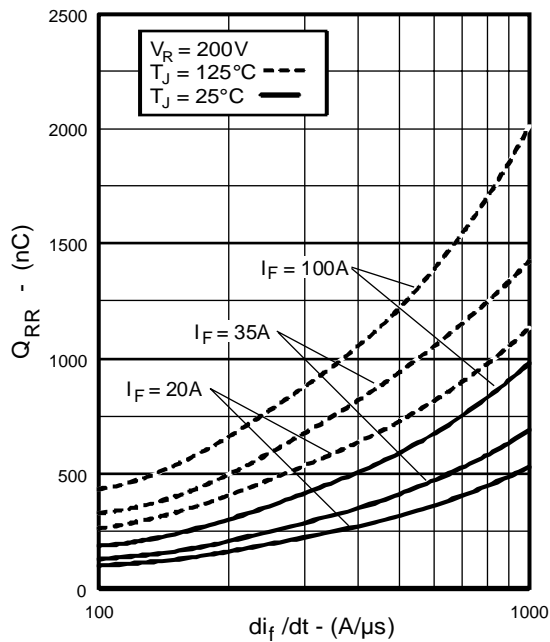

Fig. 7 - Typical Stored Charge vs. di_f/dt , (per Leg)

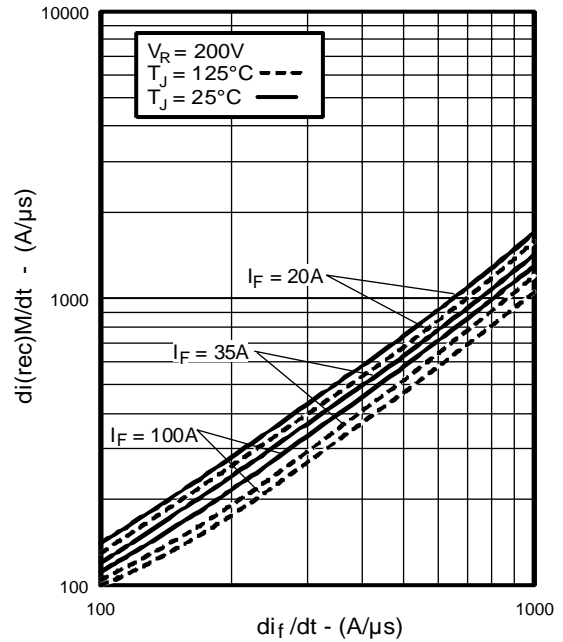

Fig. 8 - Typical $di_{(rec)M}/dt$ vs. di_f/dt , (per Leg)

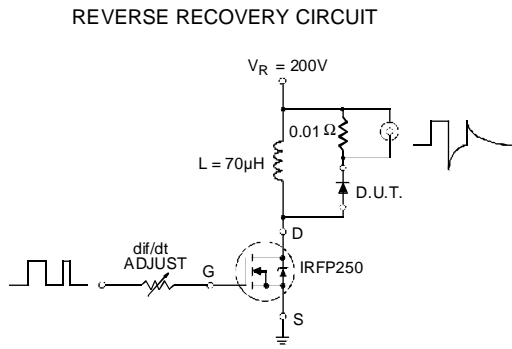

Fig. 9 - Reverse Recovery Parameter Test Circuit

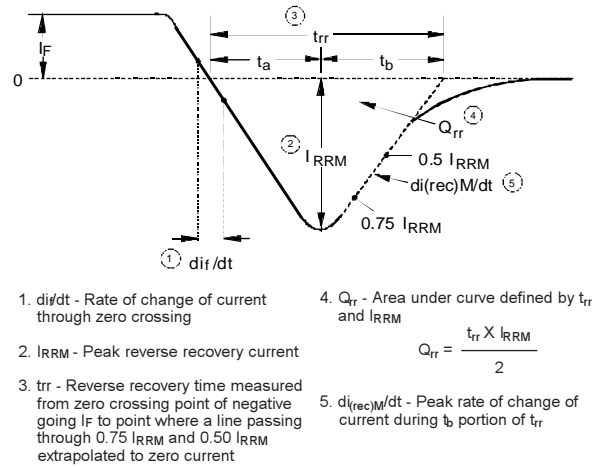

Fig. 10 - Reverse Recovery Waveform and Definitions

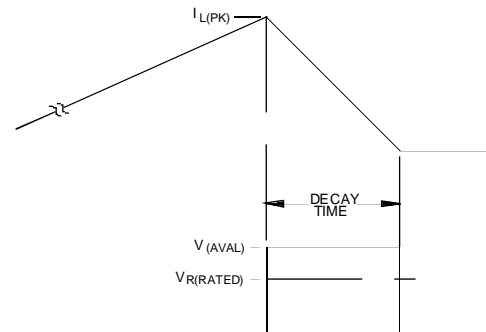
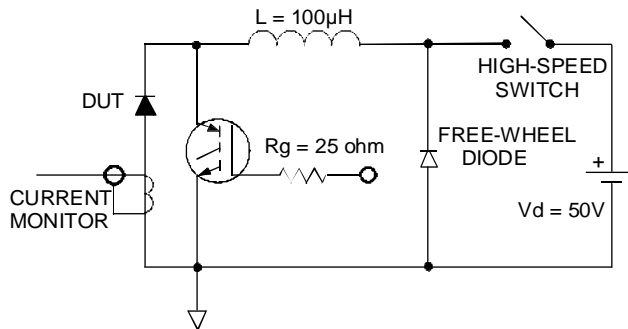

Fig. 11 - Avalanche Test Circuit and Waveforms

Looking for pricing, stock, or lifecycle information?

Click below to explore more details on WIN SOURCE:

 [View HFA75MC40C on WIN SOURCE](#)

 [Vishay Information](#)

Optimize Your Supply Chain with WIN SOURCE Solutions

-  Global Sourcing Solution
-  Obsolete Management
-  Cost Control Management
-  Shortage Management
-  Alternative Solution
-  Excess Inventory Management