



THE DATASHEET OF HFA140NH60



Features

- Reduced RFI and EMI
- Reduced Snubbing
- Extensive Characterization of Recovery Parameters

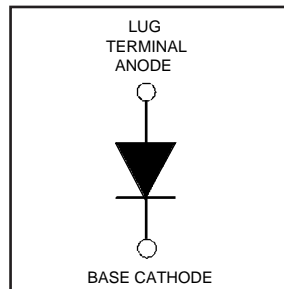

| |
|--|
| $V_R = 600V$ |
| $V_F(\text{typ.})^{\textcircled{3}} = 1.3V$ |
| $I_{F(AV)} = 140A$ |
| $Q_{rr}(\text{typ.}) = 490nC$ |
| $I_{RRM}(\text{typ.}) = 9.3A$ |
| $t_{rr}(\text{typ.}) = 39ns$ |
| $di_{(rec)M}/dt(\text{typ.})^{\textcircled{3}} = 200A/\mu s$ |

Description

HEXFRED™ diodes are optimized to reduce losses and EMI/RFI in high frequency power conditioning systems. An extensive characterization of the recovery behavior for different values of current, temperature and di/dt simplifies the calculations of losses in the operating conditions. The softness of the recovery eliminates the need for a snubber in most applications. These devices are ideally suited for power converters, motors drives and other applications where switching losses are significant portion of the total losses.

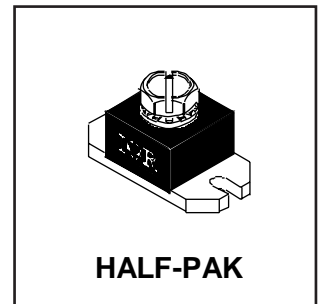

Absolute Maximum Ratings (per Leg)

| | Parameter | Max. | Units |
|---------------------------|---|-------------|------------|
| V_R | Cathode-to-Anode Voltage | 600 | V |
| $I_F @ T_C = 25^\circ C$ | Continuous Forward Current | 222 | A |
| $I_F @ T_C = 100^\circ C$ | Continuous Forward Current | 111 | |
| I_{FSM} | Single Pulse Forward Current ① | 800 | |
| E_{AS} | Non-Repetitive Avalanche Energy ② | 220 | μJ |
| $P_D @ T_C = 25^\circ C$ | Maximum Power Dissipation | 625 | W |
| $P_D @ T_C = 100^\circ C$ | Maximum Power Dissipation | 250 | |
| T_J T_{STG} | Operating Junction and Storage Temperature Range | -55 to +150 | $^\circ C$ |

Thermal - Mechanical Characteristics

| | Parameter | Min. | Typ. | Max. | Units |
|------------|-------------------------------------|----------|----------|----------|--------------|
| R_{thJC} | Junction-to-Case | — | — | 0.20 | $^\circ C/W$ |
| R_{thCS} | Case-to-Sink, Flat, Greased Surface | — | 0.15 | — | K/W |
| Wt | Weight | — | 26 (0.9) | — | g (oz) |
| | Mounting Torque ④ | 15 (1.7) | — | 25 (2.8) | lbf•in |
| | Terminal Torque | 30 (3.4) | — | 40 (4.6) | (N•m) |
| | Vertical Pull | — | — | 35 | lbf•in |
| | 2 inch Lever Pull | — | — | 35 | |

Note: ① Limited by junction temperature
 ② $L = 100\mu H$, duty cycle limited by max T_J
 ③ $125^\circ C$

④ Mounting surface must be smooth, flat, free of burrs or other protrusions. Apply a thin even film of thermal grease to mounting surface. Gradually tighten each mounting bolt in 5-10 lbf•in steps until desired or maximum torque limits are reached. Module

HFA140NH60

PD-2.447 rev. B 03/99

International
IOR Rectifier

Electrical Characteristics (per Leg) @ $T_J = 25^\circ\text{C}$ (unless otherwise specified)

| Parameter | Min. | Typ. | Max. | Units | Test Conditions |
|--|------|------|------|---------------|--|
| V_{BR} Cathode Anode Breakdown Voltage | 600 | — | — | V | $I_R = 100\mu\text{A}$ |
| V_{FM} Max Forward Voltage See Fig. 1 | — | 1.4 | 1.6 | V | $I_F = 140\text{A}$ |
| | — | 1.6 | 1.8 | | $I_F = 280\text{A}$ |
| | — | 1.3 | 1.5 | | $I_F = 140\text{A}, T_J = 125^\circ\text{C}$ |
| I_{RM} Max Reverse Leakage Current See Fig. 2 | — | 8.0 | 40 | μA | $V_R = V_R \text{ Rated}$ |
| | — | 2.0 | 8.0 | mA | $T_J = 125^\circ\text{C}, V_R = 480\text{V}$ |
| C_T Junction Capacitance See Fig. 3 | — | 280 | 400 | pF | $V_R = 200\text{V}$ |
| L_S Series Inductance | — | 5.0 | — | nH | From top of terminal hole to mounting plane |

Dynamic Recovery Characteristics (per Leg) @ $T_J = 25^\circ\text{C}$ (unless otherwise specified)

| Parameter | Min. | Typ. | Max. | Units | Test Conditions | |
|--|------|------|------|------------------------|--|---------------------------|
| t_{rr} Reverse Recovery Time See Fig. 5 | — | 39 | — | ns | $I_F = 1.0\text{A}, di_f/dt = 200\text{A}/\mu\text{s}, V_R = 30\text{V}$ $T_J = 25^\circ\text{C}$ | |
| t_{rr1} | — | 92 | 140 | | | $T_J = 125^\circ\text{C}$ |
| t_{rr2} | — | 180 | 270 | | | |
| I_{RRM1} Peak Recovery Current See Fig. 6 | — | 9.3 | 17 | A | $T_J = 25^\circ\text{C}$ $T_J = 125^\circ\text{C}$ | |
| I_{RRM2} | — | 16 | 30 | | | |
| Q_{rr1} Reverse Recovery Charge See Fig. 7 | — | 490 | 1200 | nC | $T_J = 25^\circ\text{C}$ $T_J = 125^\circ\text{C}$ | |
| Q_{rr2} | — | 1400 | 4000 | | | |
| $di_{(rec)M}/dt1$ Peak Rate of Fall of Recovery Current $di_{(rec)M}/dt2$ During t_b See Fig. 8 | — | 290 | — | $\text{A}/\mu\text{s}$ | $T_J = 25^\circ\text{C}$ $T_J = 125^\circ\text{C}$ | |
| | — | 200 | — | | | |

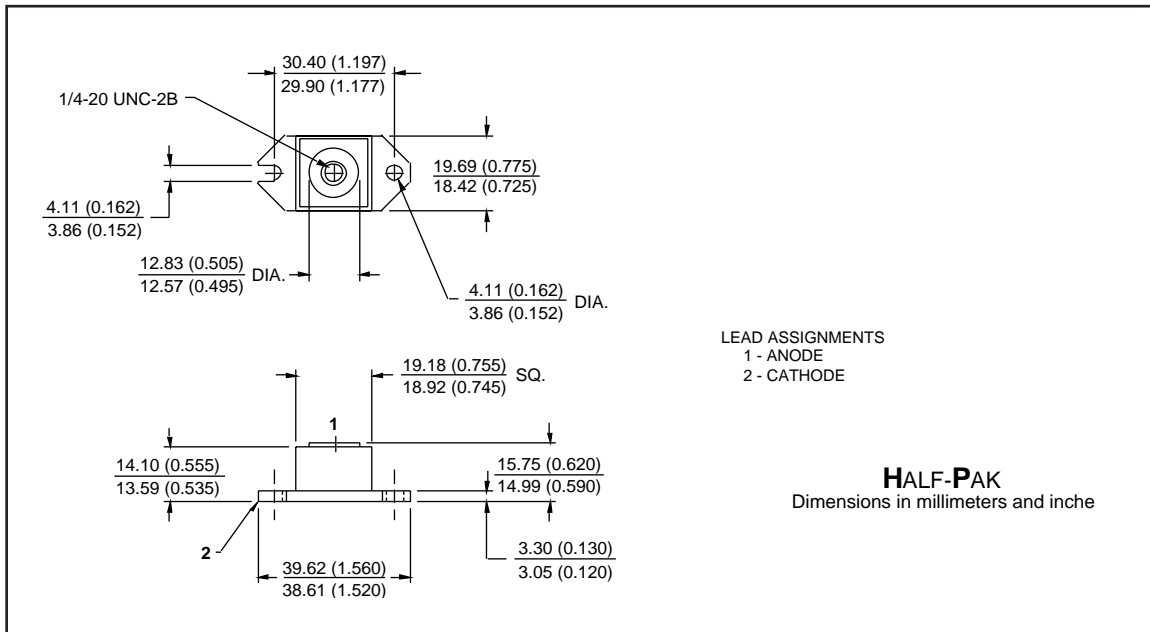

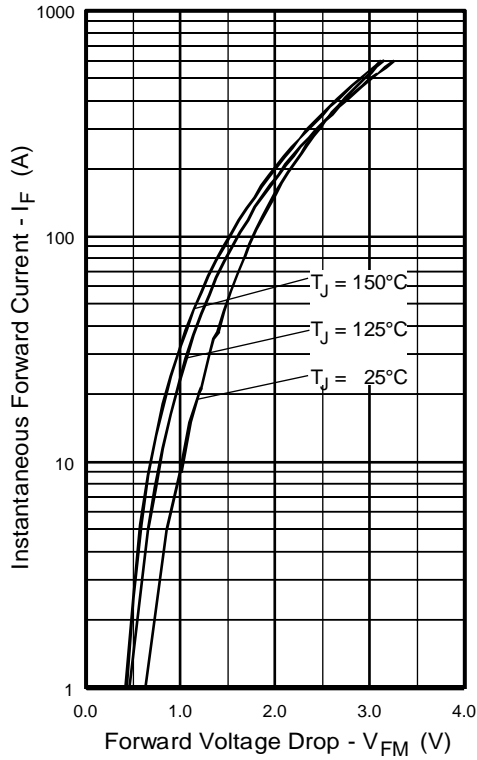

Fig. 1 - Maximum Forward Voltage Drop vs. Instantaneous Forward Current

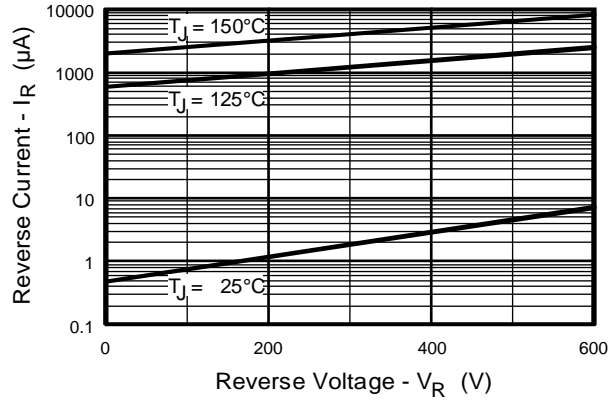

Fig. 2 - Typical Reverse Current vs. Reverse Voltage

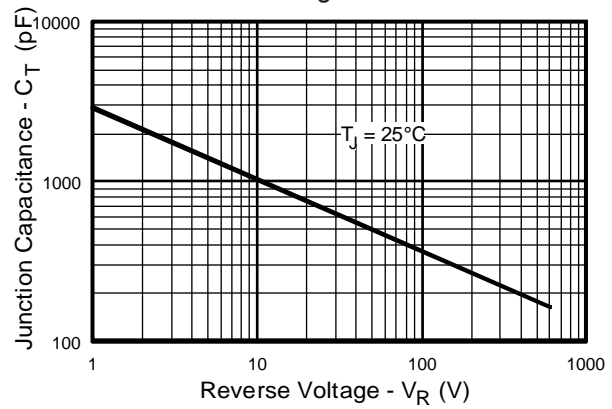

Fig. 3 - Typical Junction Capacitance vs. Reverse Voltage

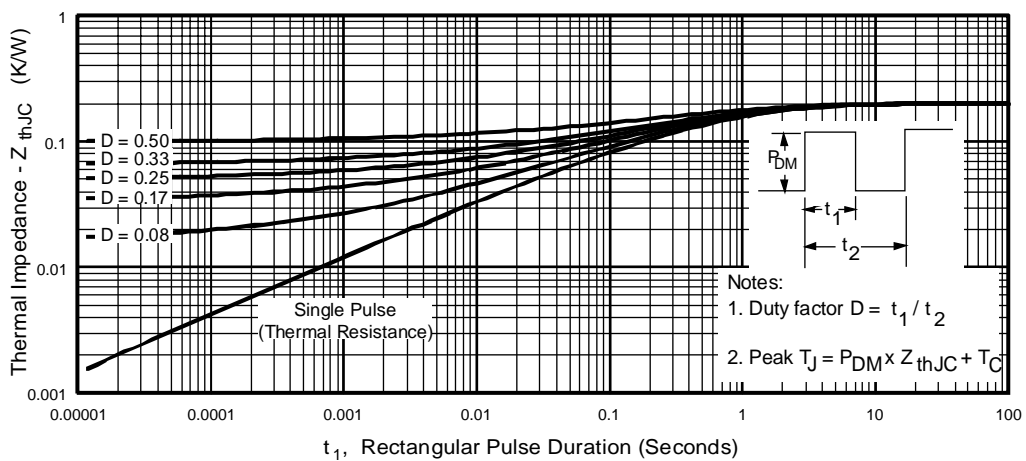

Fig. 4 - Maximum Thermal Impedance Z_{thJC} Characteristics

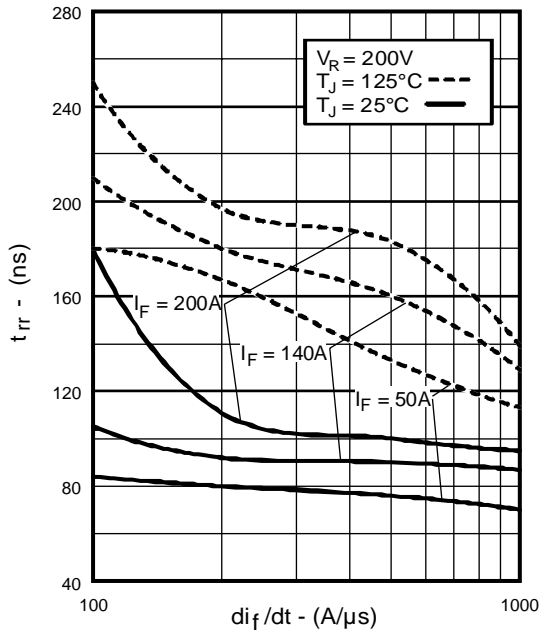

Fig. 5 - Typical Reverse Recovery vs. di_f/dt

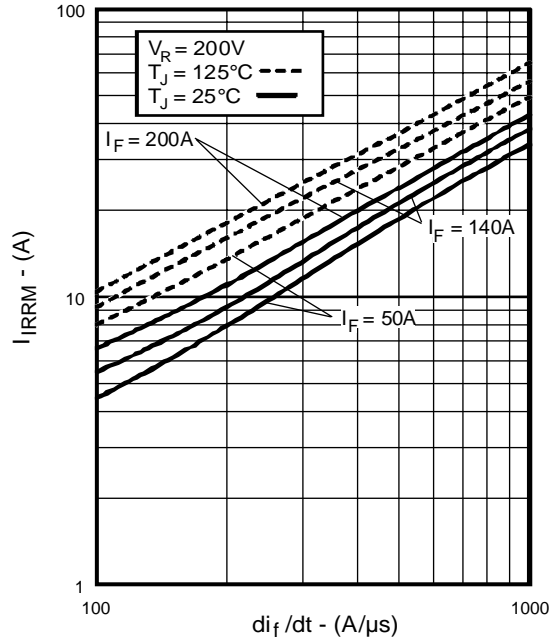

Fig. 6 - Typical Recovery Current vs. di_f/dt

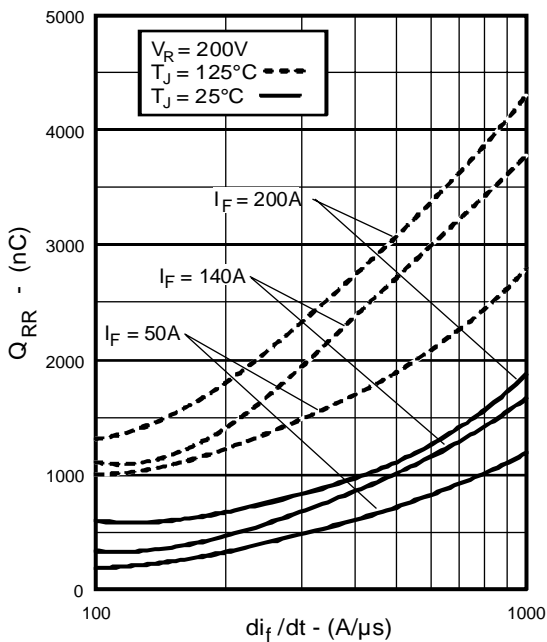

Fig. 7 - Typical Stored Charge vs. di_f/dt

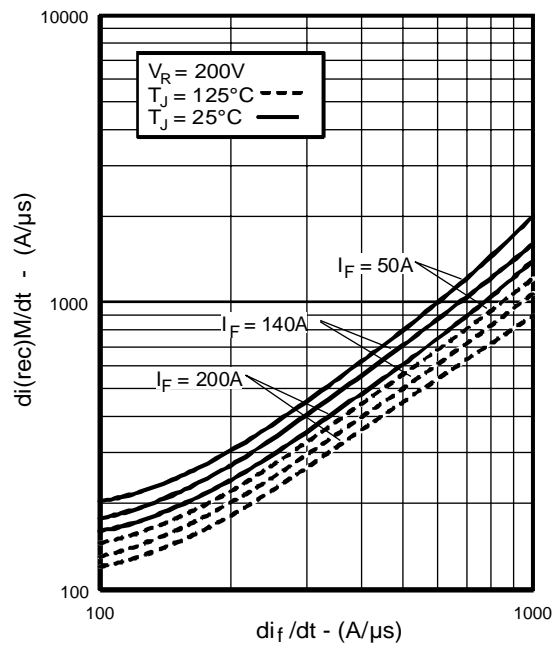

Fig. 8 - Typical $di_{(rec)M}/dt$ vs. di_f/dt

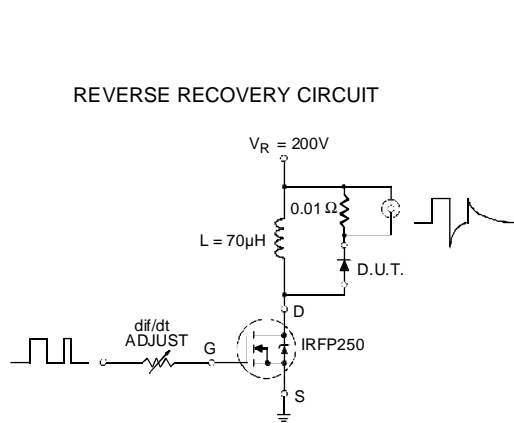

Fig. 9 - Reverse Recovery Parameter Test Circuit

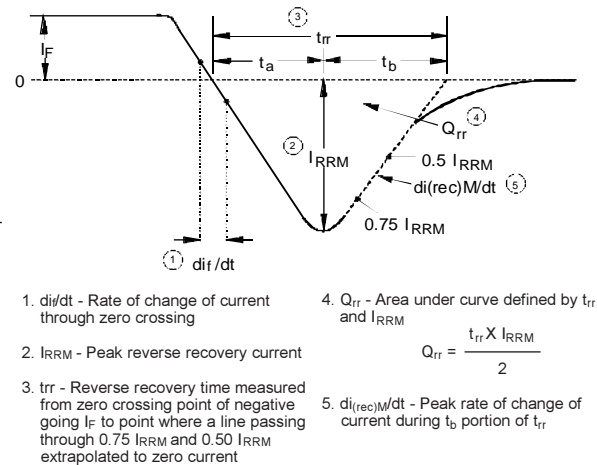

Fig. 10 - Reverse Recovery Waveform and Definitions

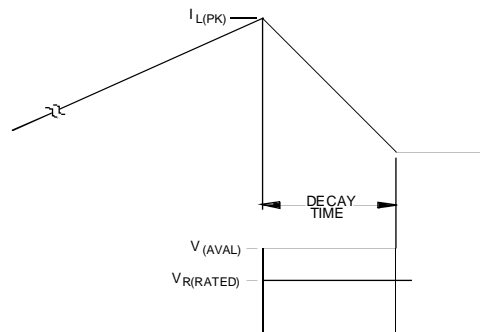
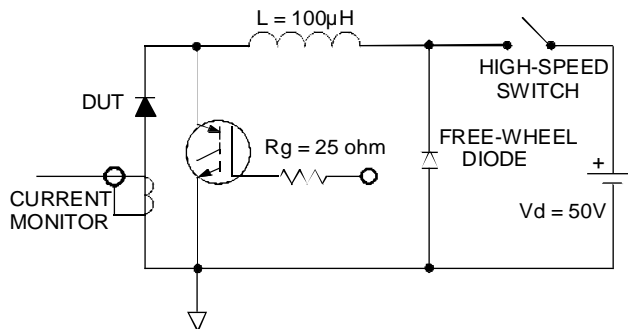



Fig. 11 - Avalanche Test Circuit and Waveforms

Looking for pricing, stock, or lifecycle information?

Click below to explore more details on WIN SOURCE:

-  [View HFA140NH60 on WIN SOURCE](#)
-  [Vishay Information](#)

Optimize Your Supply Chain with WIN SOURCE Solutions

-  Global Sourcing Solution
-  Obsolete Management
-  Cost Control Management
-  Shortage Management
-  Alternative Solution
-  Excess Inventory Management