



**THE DATASHEET OF  
HDSP-K511-GH000**



# HDSP-Ax11

## Black Surface Seven Segment Displays



### Data Sheet



#### HDSP-AX11/-AX13 Series, HDSP-FX11/-FX13 Series HDSP-GX11/-GX13 Series, HDSP-HX11/-HX13 Series HDSP-KX11/-KX13 Series

#### Description

These devices use industry standard size package and pinout. Available with black surface finish. All devices are available as either common anode or common cathode.

Typical applications include appliances, channel indicators of TV, CATV converters, game machines, and point of sale terminals.

#### Features

- **Black surface and color tinted epoxy**
- **Industry standard size**
- **Industry standard pinout**
- **Choice of character size**  
7.6 mm (0.30 in.), 10 mm (0.40 in.), 14.2 mm (0.56 in.)
- **Choice of colors**  
AlGaAs Red, High Efficiency Red (HER), Green, Orange
- **Excellent appearance**  
Evenly lighted segments  
± 50° Viewing angle
- **Design flexibility**  
Common anode or common cathode  
Single and two digit
- **Categorized for luminous intensity**  
Categorized for color: Green  
Use of like categories yields a uniform display
- **Excellent for long digit string multiplexing**

#### Devices

Orange HDSP-	AlGaAs Red HDSP-	HER HDSP-	Green HDSP-	Description	Package Drawing
A411	A111	A211	A511	7.6 mm Common Anode Right Hand Decimal	A
A413	A113	A213	A513	7.6 mm Common Cathode Right Hand Decimal	B
F411	F111	F211	F511	10 mm Common Anode Right Hand Decimal	C
F413	F113	F213	F513	10 mm Common Cathode Right Hand Decimal	D
G411	G111	G211	G511	10 mm Two Digit Common Anode Right Hand Decimal	E
G413	G113	G213	G513	10 mm Two Digit Common Cathode Right Hand Decimal	F
H411	H111	H211	H511	14.2 mm Common Anode Right Hand Decimal	G
H413	H113	H213	H513	14.2 mm Common Cathode Right Hand Decimal	H
K411	K111	K211	K511	14.2 mm Two Digit Common Anode Right Hand Decimal	I
K413	K113	K213	K513	14.2 mm Two Digit Common Cathode Right Hand Decimal	J

**Part Numbering System**

5082 - X X X X-X X X X X  
 HDSP-X X X X-X X X X X

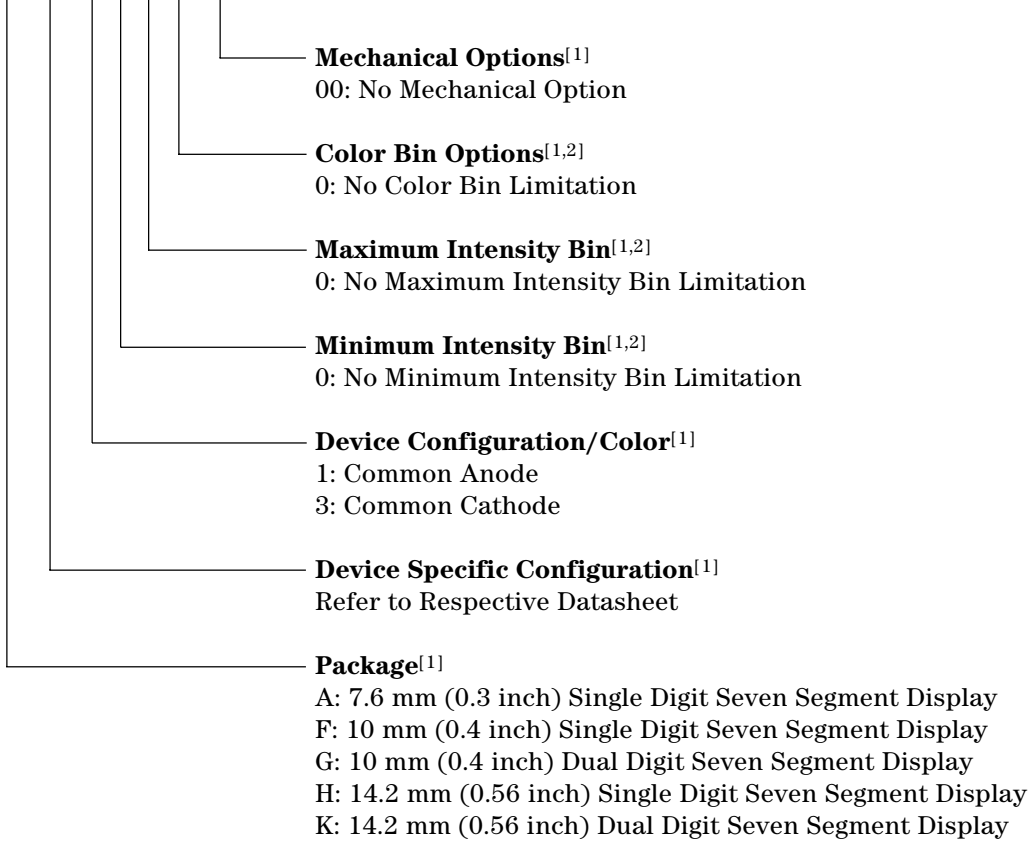

**Notes:**

1. For codes not listed in the figure above, please refer to the respective datasheet or contact your nearest Avago representative for details.
2. Bin options refer to shippable bins for a part number. Color and Intensity Bins are typically restricted to 1 bin per tube (exceptions may apply). Please refer to respective datasheet for specific bin limit information.

### Package Dimensions (7.6 mm Series)

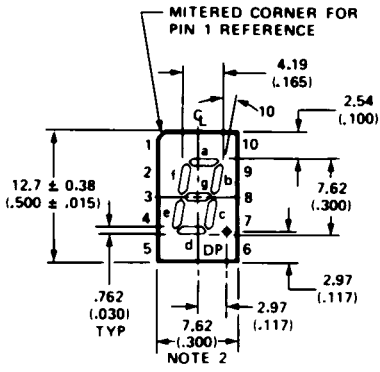

A, B

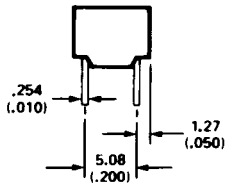

A, B

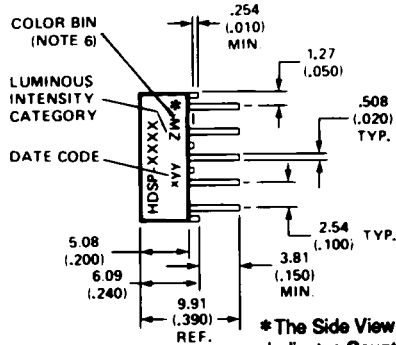

\*The Side View of package indicates Country of Origin.

PIN	FUNCTION	
	A	B
1	ANODE <sup>[4]</sup>	CATHODE <sup>[5]</sup>
2	CATHODE f	ANODE f
3	CATHODE g	ANODE g
4	CATHODE e	ANODE e
5	CATHODE d	ANODE d
6	ANODE <sup>[4]</sup>	CATHODE <sup>[5]</sup>
7	CATHODE DP	ANODE DP
8	CATHODE c	ANODE c
9	CATHODE b	ANODE b
10	CATHODE a	ANODE a

**NOTES:**

1. ALL DIMENSIONS IN MILLIMETERS (INCHES).
2. MAXIMUM.
3. ALL UNTOLERANCED DIMENSIONS ARE FOR REFERENCE ONLY.
4. REDUNDANT ANODES.
5. REDUNDANT CATHODES.
6. FOR HDSP-A511/-A513 ONLY.

### Internal Circuit Diagram

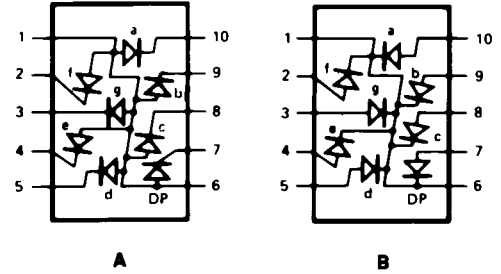

A

B

### Package Dimensions (10 mm Series: Single)

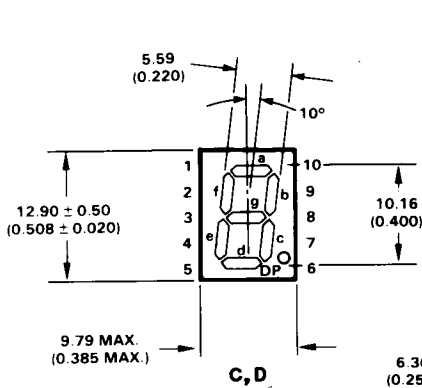

C, D

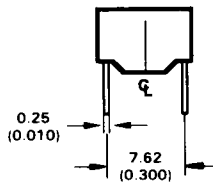

C, D

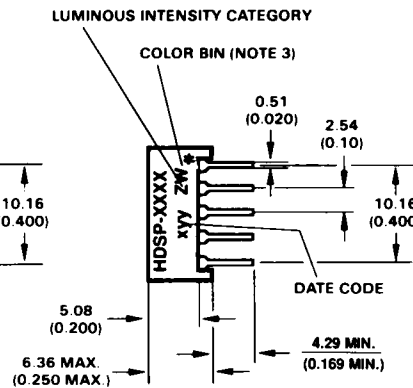

C, D

\*The Side View of package indicates Country of Origin.

PIN	FUNCTION	
	C	D
1	ANODE <sup>[4]</sup>	CATHODE <sup>[5]</sup>
2	CATHODE f	ANODE f
3	CATHODE g	ANODE g
4	CATHODE e	ANODE e
5	CATHODE d	ANODE d
6	ANODE <sup>[4]</sup>	CATHODE <sup>[5]</sup>
7	CATHODE DP	ANODE DP
8	CATHODE c	ANODE c
9	CATHODE b	ANODE b
10	CATHODE a	ANODE a

**NOTES:**

1. ALL DIMENSIONS IN MILLIMETERS (INCHES).
2. ALL UNTOLERANCED DIMENSIONS ARE FOR REFERENCE ONLY.
3. FOR HDSP-F511/-F513 ONLY.
4. REDUNDANT ANODES.
5. REDUNDANT CATHODES.

### Internal Circuit Diagram

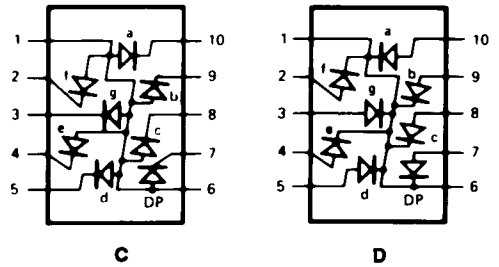

C

D

Package Dimensions (10 mm Series: Two Digit)



E, F

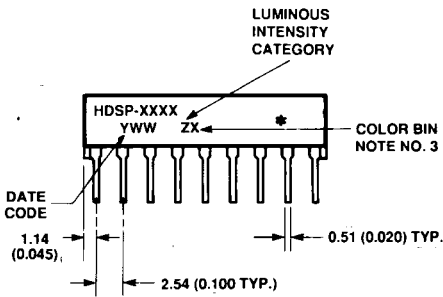

E, F

Internal Circuit Diagram

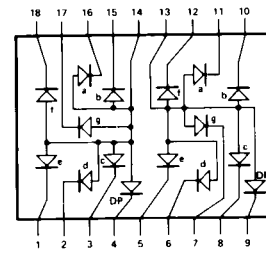

E

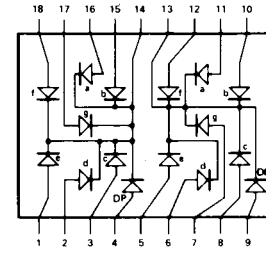

F

PIN	FUNCTION	
	E	F
1	E CATHODE NO. 1	E ANODE NO. 1
2	D CATHODE NO. 1	D ANODE NO. 1
3	C CATHODE NO. 1	C ANODE NO. 1
4	DP CATHODE NO. 1	DP ANODE NO. 1
5	E CATHODE NO. 2	E ANODE NO. 2
6	D CATHODE NO. 2	D ANODE NO. 2
7	G CATHODE NO. 2	G ANODE NO. 2
8	C CATHODE NO. 2	C ANODE NO. 2
9	CP CATHODE NO. 2	DP ANODE NO. 2
10	B CATHODE NO. 2	B ANODE NO. 2
11	A CATHODE NO. 2	A ANODE NO. 2
12	F CATHODE NO. 2	F ANODE NO. 2
13	DIGIT NO. 2 ANODE	DIGIT NO. 2 CATHODE
14	DIGIT NO. 1 ANODE	DIGIT NO. 1 CATHODE
15	B CATHODE NO. 1	B ANODE NO. 1
16	A CATHODE NO. 2	A ANODE NO. 1
17	G CATHODE NO. 1	G ANODE NO. 1
18	F CATHODE NO. 1	F ANODE NO. 1

NOTES:

1. DIMENSIONS ARE IN MILLIMETERS (INCHES).
2. ALL UNTOLERANCED DIMENSIONS ARE FOR REFERENCE ONLY.
3. FOR HDSP-G511/G513 ONLY.

\* The Side View of package indicates Country of Origin.



HOLE PATTERN FOR PCB LAYOUT TO ACHIEVE UNIFORM 0.450 DIGIT TO DIGIT PITCH. FOR HDSP-FXXX TO HDSP-GXXX.

Package Dimensions (14.2 mm Series: Single)



G, H

\*The End View of package indicates Country of Origin.

PIN	FUNCTION	
	G	H
1	CATHODE e	ANODE e
2	CATHODE d	ANODE d
3	ANODE <sup>(3)</sup>	CATHODE <sup>(4)</sup>
4	CATHODE c	ANODE c
5	CATHODE DP	ANODE DP
6	CATHODE b	ANODE b
7	CATHODE a	ANODE a
8	ANODE <sup>(3)</sup>	CATHODE <sup>(4)</sup>
9	CATHODE f	ANODE f
10	CATHODE g	ANODE g

- NOTES:  
 1. ALL DIMENSIONS IN MILLIMETERS (INCHES).  
 2. ALL UNTOLERANCED DIMENSIONS ARE FOR REFERENCE ONLY.  
 3. REDUNDANT ANODES.  
 4. REDUNDANT CATHODES.  
 5. FOR HDSP-H511/H513 ONLY.

Internal Circuit Diagram



G



H

Package Dimensions (14.2 mm Series: Two Digit)

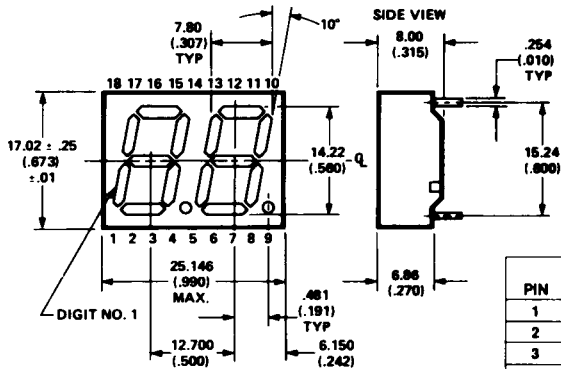

I, J



\*The Side View of package indicates Country of Origin.

PIN	FUNCTION	
	I	J
1	E CATHODE NO. 1	E ANODE NO. 1
2	D CATHODE NO. 1	D ANODE NO. 1
3	C CATHODE NO. 1	C ANODE NO. 1
4	DP CATHODE NO. 1	DP ANODE NO. 1
5	E CATHODE NO. 2	E ANODE NO. 2
6	D CATHODE NO. 2	D ANODE NO. 2
7	G CATHODE NO. 2	G ANODE NO. 2
8	C CATHODE NO. 2	C ANODE NO. 2
9	DP CATHODE NO. 2	DP ANODE NO. 2
10	B CATHODE NO. 2	B ANODE NO. 2
11	A CATHODE NO. 2	A ANODE NO. 2
12	F CATHODE NO. 2	F ANODE NO. 2
13	DIGIT NO. 2 ANODE	DIGIT NO. 2 CATHODE
14	DIGIT NO. 1 ANODE	DIGIT NO. 1 CATHODE
15	B CATHODE NO. 1	B ANODE NO. 1
16	A CATHODE NO. 1	A ANODE NO. 1
17	G CATHODE NO. 1	G ANODE NO. 1
18	F CATHODE NO. 1	F ANODE NO. 1

- NOTES:  
 1. ALL DIMENSIONS IN MILLIMETERS (INCHES).  
 2. ALL UNTOLERANCED DIMENSIONS ARE FOR REFERENCE ONLY.  
 3. FOR HDSP-K511/K513 ONLY.

Internal Circuit Diagram

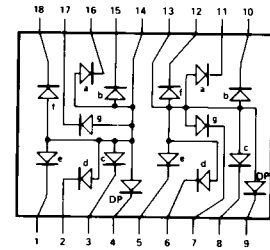

I

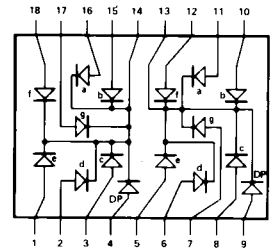

J

## Absolute Maximum Ratings

Description	AlGaAs Red HDSP-X11X Series	HER/Orange HDSP-X21X/X41X Series	Green HDSP-X51X Series	Units
Average Power per Segment or DP	37	105	105	mW
Peak Forward Current per Segment or DP	45	90 <sup>[1]</sup>	90 <sup>[3]</sup>	mA
DC Forward Current per Segment or DP	15 <sup>[5]</sup>	30 <sup>[2]</sup>	30 <sup>[4]</sup>	mA
Operating Temperature Range	-20 to +100	-40 to +100		°C
Storage Temperature Range	-55 to +100			°C
Reverse Voltage per Segment or DP	3.0			V
Wave Soldering Temperature for 3 Seconds (1.60 mm [0.063 in.] below Body)	250			°C

### Notes:

1. See Figure 5 to establish pulsed conditions.
2. Derate above 53°C at 0.45 mA/°C (see Figure 7).
3. See Figure 6 to establish pulsed conditions.
4. Derate above 39°C at 0.37 mA/°C (see Figure 7).
5. Derate above 91°C at 0.53 mA/°C (see Figure 1).

## Electrical/Optical Characteristics at T<sub>A</sub> = 25°C AlGaAs Red

Device Series HDSP-	Parameter	Symbol	Min.	Typ.	Max.	Units	Test Conditions
A11X	Luminous Intensity/Segment <sup>[1,2]</sup> (Digit Average)	I <sub>V</sub>	315	600		μcd	I <sub>F</sub> = 1 mA
				3600			I <sub>F</sub> = 5 mA
F11X, G11X			330	650			I <sub>F</sub> = 1 mA
				3900			I <sub>F</sub> = 5 mA
H11X, K11X			400	700			I <sub>F</sub> = 1 mA
				4200			I <sub>F</sub> = 5 mA
All Devices	Forward Voltage/Segment or DP	V <sub>F</sub>		1.6	2.0	V	I <sub>F</sub> = 1 mA
				1.7			I <sub>F</sub> = 5 mA
				1.8	22		I <sub>F</sub> = 20 mA Peak
	Peak Wavelength	λ <sub>PEAK</sub>		645		nm	
	Dominant Wavelength <sup>[3]</sup>	λ <sub>d</sub>		637		nm	
	Reverse Voltage/Segment or DP <sup>[4]</sup>	V <sub>R</sub>	3.0	15		V	I <sub>R</sub> = 100 μA
	Temperature Coefficient of V <sub>F</sub> /Segment or DP	ΔV <sub>F</sub> /°C		-2		mV/°C	
A11X	Thermal Resistance LED Junction-to-Pin	Rθ <sub>J-PIN</sub>		255		°C/W/ Seg.	
F11X, G11X				320			
H11X, K12X				400			

## Orange

Device Series HDSP-	Parameter	Symbol	Min.	Typ.	Max.	Units	Test Conditions
A41X	Luminous Intensity/Segment (Segment Average) <sup>[1,2]</sup>	$I_V$		0.70		mcd	$I_F = 5 \text{ mA}$
F41X, G41X				1.0			$I_F = 5 \text{ mA}$
H41X, K41X				2.37			$I_F = 10 \text{ mA}$
All Devices	Forward Voltage/Segment or DP	$V_F$		2.0	2.5	V	$I_F = 20 \text{ mA}$
	Peak Wavelength	$\lambda_{PEAK}$		600		nm	
	Dominant Wavelength <sup>[3]</sup>	$\lambda_d$		603		nm	
	Reverse Voltage/Segment or DP <sup>[4]</sup>	$V_R$	3.0	30		V	$I_R = 100 \mu\text{A}$
	Temperature Coefficient of $V_F$ /Segment or DP	$\Delta V_F / ^\circ\text{C}$		-2		mV/ $^\circ\text{C}$	
A41X	Thermal Resistance LED Junction-to-Pin	$R\theta_{J-PIN}$		200		$^\circ\text{C}/\text{W}/$ Seg.	
F41X, G41X				320			
H41X, K41X				345			

## High Efficiency Red

Device Series HDSP-	Parameter	Symbol	Min.	Typ.	Max.	Units	Test Conditions
A21X	Luminous Intensity/Segment <sup>[1,2]</sup> (Digit Average)	$I_V$		360	980	$\mu\text{cd}$	$I_F = 5 \text{ mA}$
F21X, G21X				5390			$I_F = 20 \text{ mA}$
				420	1200		$I_F = 5 \text{ mA}$
H21X, K21X				900	2800		$I_F = 10 \text{ mA}$
All Devices	Forward Voltage/Segment or DP	$V_F$		2.0	2.5	V	$I_F = 20 \text{ mA}$
	Peak Wavelength	$\lambda_{PEAK}$		635		nm	
	Dominant Wavelength <sup>[3]</sup>	$\lambda_d$		626		nm	
	Reverse Voltage/Segment or DP <sup>[4]</sup>	$V_R$	3.0	30		V	$I_R = 100 \mu\text{A}$
	Temperature Coefficient of $V_F$ /Segment or DP	$\Delta V_F / ^\circ\text{C}$		-2		mV/ $^\circ\text{C}$	
A21X	Thermal Resistance LED Junction-to-Pin	$R\theta_{J-PIN}$		200		$^\circ\text{C}/\text{W}/$ Seg.	
F21X, G21X				320			
H21X, K21X				345			

## High Performance Green

Device Series		Parameter	Symbol	Min.	Typ.	Max.	Units	Test Conditions
HDSP-								
A51X	Luminous Intensity/Segment <sup>[1,2]</sup> (Digit Average)		$I_V$	860	3000		$\mu\text{cd}$	$I_F = 10 \text{ mA}$
						6800		
F51X, G51X				1030	3500			$I_F = 10 \text{ mA}$
H51X, K51X				900	2500			$I_F = 10 \text{ mA}$
					3100			$I_F = 60 \text{ mA Peak: 1/6 Duty Factor}$
All Devices	Forward Voltage/Segment or DP	$V_F$		2.1	2.5		V	$I_F = 10 \text{ mA}$
	Peak Wavelength	$\lambda_{\text{PEAK}}$			566		nm	
	Dominant Wavelength <sup>[3,5]</sup>	$\lambda_d$			571	577	nm	
	Reverse Voltage/Segment or DP <sup>[4]</sup>	$V_R$	3.0	50			V	$I_R = 100 \mu\text{A}$
	Temperature Coefficient of $V_F$ /Segment or DP	$\Delta V_F / ^\circ\text{C}$			-2			mV/ $^\circ\text{C}$
A51X	Thermal Resistance LED Junction-to-Pin		$R_{\theta_{J-PIN}}$		200		$^\circ\text{C/W/Seg.}$	
F51X, G51X					320			
H51X, K51X					345			

### Notes:

- Case temperature of device immediately prior to the intensity measurement is 25°C.
- The digits are categorized for luminous intensity. The intensity category is designated by a letter on the side of the package.
- The dominant wavelength,  $\lambda_d$ , is derived from the CIE chromaticity diagram and is that single wavelength which defines the color of the device.
- Typical specification for reference only. Do not exceed absolute maximum ratings.
- Green (HDSP-A51X/F51X/G51X/H512X/K51X) series displays are categorized for dominant wavelength. The category is designated by a number adjacent to the luminous intensity category letter.

# AlGaAs Red



Figure 1. Maximum allowable average or dc current vs. ambient temperature.



Figure 2. Forward current vs. forward voltage.



Figure 3. Relative luminous intensity vs. dc forward current.

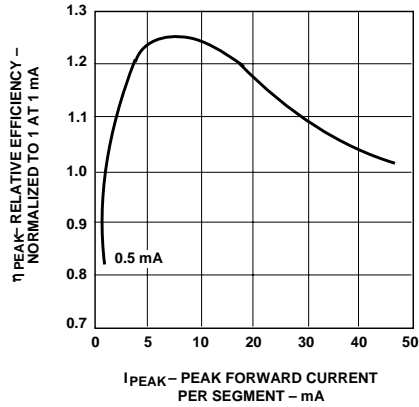

Figure 4. Relative efficiency (luminous intensity per unit current) vs. peak current.

HER, Green, Orange



Figure 5. Maximum tolerable peak current vs. pulse duration – HER, Orange.



Figure 6. Maximum tolerable peak current vs. pulse duration – Green.



Figure 7. Maximum allowable dc current vs. ambient temperature.



Figure 8. Forward current vs. forward voltage characteristics.



Figure 9. Relative luminous intensity vs. dc forward current.

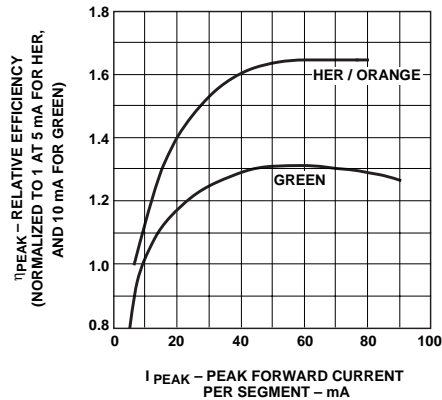

Figure 10. Relative efficiency (luminous intensity per unit current) vs. peak current.

**Intensity Bin Limits (mcd)****AlGaAs Red****HDSP-A1xx**

IV Bin Category	Min.	Max.
E	0.315	0.520
F	0.428	0.759
G	0.621	1.16
H	0.945	1.71
I	1.40	2.56
J	2.10	3.84
K	3.14	5.75
L	4.70	8.55

**HDSP-F1xx/G1xx**

IV Bin Category	Min.	Max.
D	0.391	0.650
E	0.532	0.923
F	0.755	1.39
G	1.13	2.08
H	1.70	3.14

**HDSP-H1xx/K1xx**

IV Bin Category	Min.	Max.
C	0.415	0.690
D	0.565	0.990
E	0.810	1.50
F	1.20	2.20
G	1.80	3.30
H	2.73	5.00
I	4.09	7.50

**Orange****HDSP-A41X**

IV Bin Category	Min	Max
A	0.284	0.433
B	0.354	0.541
C	0.443	0.677
D	0.554	0.846
E	0.692	1.057
F	0.856	1.322
G	1.082	1.652
H	1.352	2.066
I	1.692	2.581
J	2.114	3.227
K	2.641	4.034
L	3.300	5.042
M	4.127	6.303
N	5.157	7.878

**HDSP-F41X/G41X**

IV Bin Category	Min	Max
C	0.485	0.890
D	0.728	1.333
E	1.091	2.000
F	1.636	3.000
G	2.454	4.500
H	3.682	6.751

**HDSP-H41X/K41X**

IV Bin Category	Min	Max
B	0.77	1.17
C	0.95	1.45
D	1.19	1.82
E	1.49	2.27
F	1.85	2.89
G	2.32	3.54
H	2.90	4.43

**Intensity Bin Limits (mcd), continued  
HER**

---

**HDSP-A2xx**

---

<b>IV Bin Category</b>	<b>Min.</b>	<b>Max.</b>
B	0.342	0.630
C	0.516	0.946
D	0.774	1.418
E	1.160	2.127
F	1.740	3.190
G	2.610	4.785
H	3.915	7.177

---

---

**HDSP-F2xx/G2xx**

---

<b>IV Bin Category</b>	<b>Min.</b>	<b>Max.</b>
C	0.485	0.890
D	0.728	1.333
E	1.091	2.000
F	1.636	3.000
G	2.454	4.500
H	3.682	6.751

---

---

**HDSP-H2xx/K2xx**

---

<b>IV Bin Category</b>	<b>Min.</b>	<b>Max.</b>
E	0.91	1.67
F	1.37	2.51
G	2.05	3.76
H	3.08	5.64
I	4.62	8.64
J	6.93	12.70
K	10.39	19.04

---

## Intensity Bin Limits (mcd), continued Green

HDSP-A5xx		
IV Bin Category	Min.	Max.
H	0.86	1.58
I	1.29	2.37
J	1.94	3.55
K	2.90	5.33
L	4.37	8.01

HDSP-F5xx/G5xx		
IV Bin Category	Min.	Max.
H	1.54	2.82
I	2.31	4.23
J	3.46	6.34
K	5.18	9.50
L	7.78	14.26

HDSP-H5xx/K5xx		
IV Bin Category	Min.	Max.
E	0.91	1.67
F	1.37	2.51
G	2.05	3.76
H	3.08	5.64
I	4.61	8.46

## Color Categories

		Dominant Wavelength (nm)	
Color	Bin	Min.	Max.
Green	2	573.00	577.00
	3	570.00	574.00
	4	567.00	571.00
	5	564.00	568.00

### Note:

All categories are established for classification of products. Products may not be available in all categories. Please contact your Avago representatives for further clarification/information.

## Contrast Enhancement

For information on contrast enhancement, please see Application Note 1015.

## Soldering/Cleaning

For information on soldering LEDs, please refer to Application Note 1029.

## Electrical/Optical

For more information on electrical/optical characteristics, please see Application Note 1005.

For product information and a complete list of distributors, please go to our website: [www.avagotech.com](http://www.avagotech.com)

Avago, Avago Technologies, and the A logo are trademarks of Avago Technologies, Pte. in the United States and other countries.  
Data subject to change. Copyright © 2006 Avago Technologies Pte. All rights reserved. Obsoletes 5988-4433EN  
5989-2795EN April 10, 2006



## Looking for pricing, stock, or lifecycle information?

Click below to explore more details on WIN SOURCE:

 [View HDSP-K511-GH000 on WIN SOURCE](#)

 [Broadcom Limited](#) Information

## Optimize Your Supply Chain with WIN SOURCE Solutions

-  Global Sourcing Solution
-  Obsolete Management
-  Cost Control Management
-  Shortage Management
-  Alternative Solution
-  Excess Inventory Management